

SECTION INDEX Click on any section below to go to that portion for a detailed Table of Contents

Table of Contents

	A. System Overview
	B. Copper Systems
	C. Fiber Optic Systems
	D. Power over Ethernet
	E. Zone Cabling
	F. Wireless
	G. Outlets
	H. Media Distribution
	I. Physical Infrastructure Management
	J. Overhead and Underfloor Routing
	K. Surface Raceway
	L. Cabinets, Racks, and Cable Management
	M. Grounding and Bonding
	N. Industrial
	O. Labeling and Identification
	P. Cable Management Accessories
	Q. Index



Click on the logo above to go to www.panduit.com up to date product information find a local distributor technical information

CLICK on any of the tabs on this page to jump to that location within the catalog

A. System Overview

B. Copper Systems

C. Fiber Optic Systems

D. Power over Ethernet

E. Zone Cabling

F. Wireless

G. Outlets

H. Media Distribution

I. Physical Infrastructure Management

J. Overhead & Underfloor Routing

K. Surface Raceway

L. Cabinets, Racks & Cable Management

M. Grounding & Bonding

N. Industrial



O. Labeling & Identification

P. Cable Management Accessories

Q. Index

SOLUTIONS ROADMAP

From the data center to the work area to building systems and the factory floor, Panduit delivers comprehensive solutions that optimize the reliability, availability, security, integration, and safety of the physical infrastructure. Through robust, innovative systems designed for intelligent deployment and convergence, Panduit solutions help mitigate risk factors across IT, facilities, operations, and manufacturing to achieve business efficiencies with lower total cost of ownership.

1 Copper Systems	
2 Fiber Optic Systems	
3 Power over Ethernet	
4 Zone Cabling	
5 Wireless	
6 Outlets	
7 Physical Infrastructure Management	
8 Overhead and Underfloor Routing	
9 Surface Raceway	

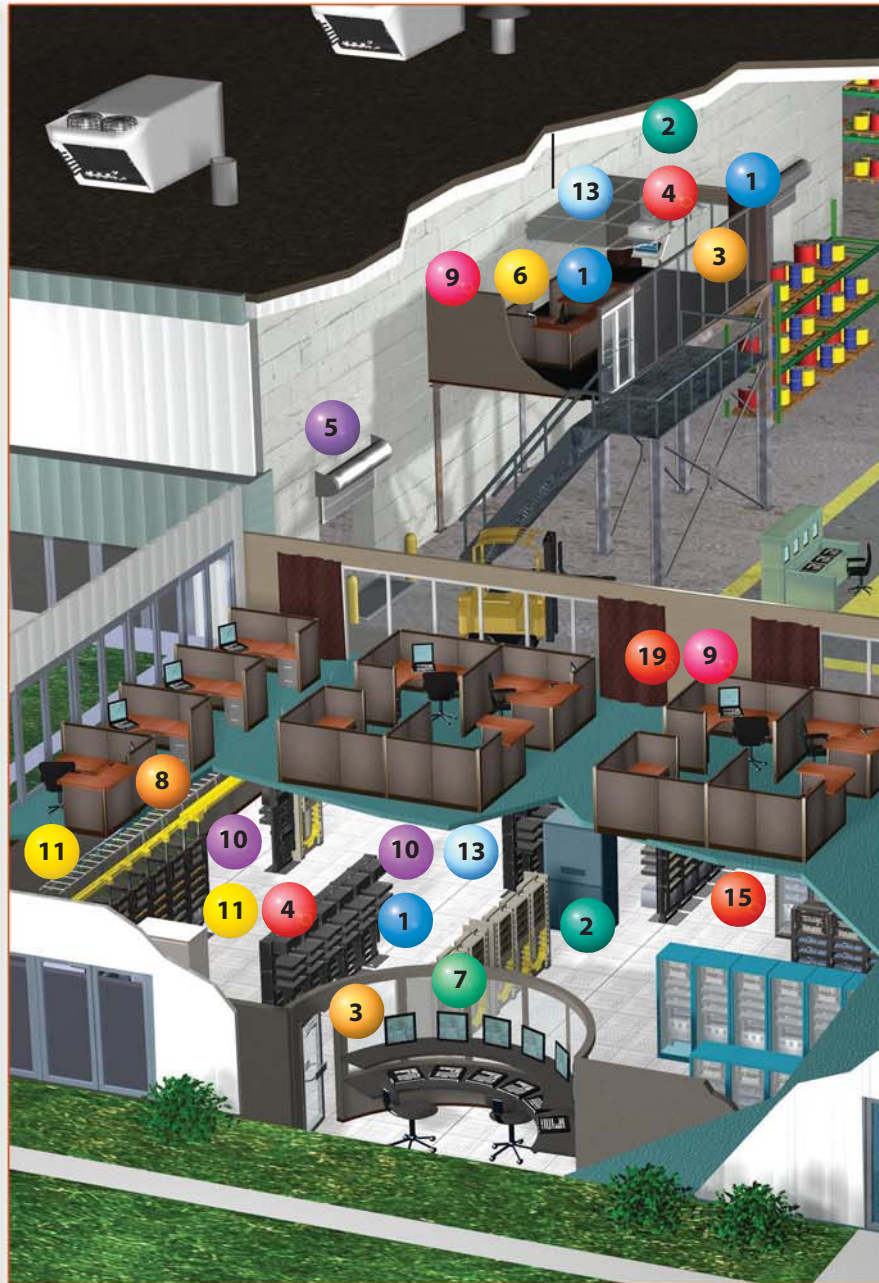



10 Cabinets, Racks,
and Cable Management



11 Power and Grounding



12 Industrial



13 Labeling and Identification



14 Wiring Duct



15 Cable Ties and Mounts



16 Stainless Steel



17 Terminals



18 Safety and Facility Solutions



19 Abrasion Protection





UNIFIED PHYSICAL INFRASTRUCTURESM APPROACH

The physical infrastructure is the basic foundation on which enterprise systems run, including voice and data communications, power, computing, control, and security systems. The need to provide real-time information, manage applications, and control functional systems through IP networking is also driving increased interdependence, between these systems through several core enterprise areas.

Panduit offers Unified Physical Infrastructure (UPI)-based solutions that help customers optimize the physical infrastructure by intelligently converging physical and logical systems. These solutions leverage real-time information to:

- Manage systems more effectively
- Maximize performance and availability
- Satisfy regulatory compliance requirements
- Increase safety and security in the workplace

As the global leader in comprehensive network solutions, Panduit helps customers manage the physical infrastructure by leveraging robust product systems, technology leadership, and global expertise and by supporting an extensive partner ecosystem, and world-renowned alliances.

Panduit systems optimize availability, reliability, security, integration and safety throughout the physical infrastructure and combine to deliver industry and application solutions that enable business agility and lowest total cost of ownership.

SOLUTIONS THAT ENABLE TECHNOLOGY

As a global leader Panduit is continually focused on industry and application challenges to create solutions that support evolving business needs. In the evaluation and development of technologies, Panduit considers the entire physical infrastructure. Issues such as convergence, interoperability, scalability, and continuity need to be addressed to reduce risk across IT, facilities, and manufacturing. This holistic approach enables business agility through robust, leading-edge systems that optimize design and deployment of the physical infrastructure – delivering maximum reliability, availability, security, integration, and safety.

PHYSICAL INFRASTRUCTURE MANAGEMENT

As consolidation, virtualization, and automation become more widely adopted to increase data center efficiency and agility, the elements of power, cooling, asset utilization, and connectivity become an important factor within data centers. This makes physical infrastructure management tools, in conjunction with existing system software management tools, critical to support the changing needs of your data center.

Panduit's Physical Infrastructure Manager™ (PIM™) Software Platform is a physical infrastructure management system for tracking the allocation and utilization of critical IT assets within the data center and throughout an enterprise. The PIM™ Software platform lays the foundation for effective Data Center Infrastructure Management (DCIM) through accurate and timely documentation of these physical assets, improved visibility into asset moves, adds, and changes, and process-driven integration with applicable management systems.

Working with PanView iQ™ (PVIQ™) System Hardware and select third-party devices, PIM™ Software provides an end-to-end physical to logical view of the data center and enterprise. This helps reduce the time from receipt of asset to deployment, and allows assets to be effectively reclaimed, re-purposed, and re-deployed. Unlike manual record keeping, PIM™ Software centralizes the collection and representation of a rich set of asset attributes, such as connectivity, space/port availability, and power/environmentals to ensure that the physical infrastructure supports mission-critical applications, enabling effective optimization of the data center's space, power, and cooling resources.

PVIQ™ System Hardware provides real-time monitoring of patch field connectivity for enhanced system security and reliability. Using hardware components placed in the network, combined with management software, patch field connections are continuously monitored, accurately documented, and automatically updated. Any change (whether planned or inadvertent) is immediately detected and alerted through the management platform. The system can even guide technicians through moves, adds, and changes, providing greater reliability, security, efficiency, and savings.

PVIQ™ System Hardware offers a unique hardware design that allows active management equipment to be installed at the back of PanView iQ™ Patch Panels, eliminating the need for additional rack space and allowing for phased installations. The system also features a web-based graphic user interface (GUI), remote accessibility, and an application program interface that integrates with third-party programs to allow utilization of familiar applications and services through the PVIQ™ System Hardware.

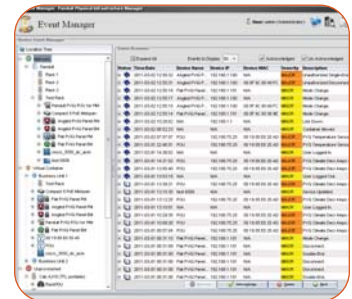

POWER OVER ETHERNET (PoE)

Since the introduction of the 2003 IEEE 802.3af Power over Ethernet (PoE) standard, customers have realized the benefits of delivering DC power over standard Category 5e, 6, and 6A copper cabling. Devices such as Voice over IP (VoIP) telephones, wireless access points, IP security cameras and building automation systems increasingly align and converge network traffic over a shared IP-based infrastructure. Because these technologies are often deployed in locations where an available power source is not readily accessible or may be cost prohibitive, supplying managed power through the data cabling is an attractive and cost saving alternative.

DPoE™ Power Patch Panels save valuable rack space in telecommunications rooms, zone enclosures, and data centers with a 1 RU design that allows PoE deployment in space-constrained locations. The DPoE™ Compact 8 Midspan provides a flexible solution for smaller installations and the innovative DC power based design is capable of supplying IEEE 802.3 af-2003 compliant and legacy PoE power to all ports. In the event of a power disruption, the port prioritization capabilities work with a network management solution to ensure that critical applications remain online and available for use, while other non-critical devices are turned off to conserve power.

DPoE™ Power over Ethernet Systems include the DPoE™ Element Manager, a software application that offers optional local and remote manageability of PoE devices and ports. Alerts can be generated on critical conditions, such as loss of power to key devices or from inadvertent disconnections. With the ability to provide location information on all ports and the panel itself, an IT manager can track critical assets and resolve concerns efficiently and effectively.

To support higher power requirements, the DPoE™ Compact 8 Midspan provides 2X power (up to 32 watts) today. Panduit also supports network transmissions up to 1GbE with the DPoE™ 1 Gig™ Power Patch Panel and the DPoE™ Compact 8 Midspan.



10 GIGABIT ETHERNET OVER COPPER

The rapid growth of network traffic and the drive to build and better utilize data centers has many organizations looking toward the benefits of 10 Gig Ethernet (10 GbE) to process, manage, and store increasingly large amounts of data across the network. Panduit 10 Gigabit Solutions incorporate innovative product systems, tools, appliances, software, and services to deliver a comprehensive strategy for unifying the installation and management of your physical infrastructure.

The Panduit® TX6A™ 10Gig™ UTP with MaTriX Technology and Shielded Copper Cabling Systems are complete end-to-end solutions for applications and industries that require increasingly complex and large-scale database processing capabilities. Both shielded or TX6A™ 10Gig™ UTP Copper Cabling System with MaTriX Technology, offer innovative design technologies that work together to suppress alien crosstalk while delivering Category 6A electrical performance. These systems provide end-users with a reliable, cost-effective, and flexible cabling infrastructure that addresses the most demanding applications, including the following:

Enterprise LAN

TX6A™ 10Gig™ UTP Copper Cabling System with MaTriX Technology supports to the desktop to run increasingly sophisticated workgroup applications. Also, with enterprises increasingly relying on VoIP, webcasting, video conferencing, and telepresence to communicate in real time across long distances, TX6A™ 10Gig™ systems enable the convergence of voice, data, and video across unified IP networks.

Data Center

Managing information is no longer enough - data centers must provide real-time access to accurate information in order to support evolving business requirements and organizational growth. TX6A™ 10Gig™ Copper solutions in the data center improve efficiencies of computer devices (servers, switches, routers) and data storage within networks. Copper solutions also support finance, health care, and science sectors that require the high bandwidth and processing power of high performance computing (HPC) clusters to conduct complex analytical modeling tasks.

Panduit also offers SFP+ 10 Gb/s Direct Attach Copper Cable Assemblies. These twinaxial cables are low power, low latency, cost effective interconnects for Top of Rack and short reach interconnects. These cable assemblies support finance, healthcare, and science sectors that require the high bandwidth and processing power of High Performance Computing (HPC) clusters to conduct complex analytical modeling tasks.



10 GIGABIT ETHERNET AND FIBRE CHANNEL OVER FIBER

The rapid growth of network traffic and the drive to build and better utilize data centers has many organizations looking toward the benefits of 10 Gigabit Ethernet (10 GbE) to process, manage, and store increasingly large amounts of data across the network. Panduit[®] 10Gig[™] Solutions incorporate innovative product systems, tools, appliances, software, and services to deliver a comprehensive strategy for unifying the installation and management of your physical infrastructure.



Panduit has developed a comprehensive suite of 10Gig[™] fiber products that push beyond the standards using Beyond the GlassSM Design Excellence. New classes of multimode fibers (ISO designated as OM3 and enhanced OM3 [ie. OM4]) enable cost-effective structured cabling solutions by employing low-cost VCSEL-based transceivers to deliver reliable 10 Gigabit Ethernet performance at a reach of up to 300 m. Such fibers also exceed media requirements of ANSI Fibre Channel for 1GFC, 2GFC, 4GFC, 8GFC, and 10GFC.

Selection of a multimode fiber structured cabling solution requires that data integrity, manageability, and security be balanced with reasonable cost expectations and future growth requirements. The availability of low-cost, high-speed transmitter technology makes 50µm laser-enhanced fiber media (i.e. OM3 and OM4) and connectivity systems a more cost-effective solution than laser-based systems. The most economical upgrade paths are those that leverage high fiber grade solutions wherever practical.

Panduit focuses on functional Bit Error Rate (BER) testing as the true determination of high-speed channel performance, and considers BER testing as the evaluation method most relevant to the reliable operation of high-speed Ethernet and Fibre Channel networks. Overall, Panduit fiber research, product development, and manufacturing expertise ensures its solutions deliver optimum performance and reliability for all network applications.

FIBER OPTIC STORAGE NETWORKING SOLUTIONS

Regulations governing data warehousing and disaster recovery are spurring the construction of high-performing, reliable, and cost-effective storage networking to store, manage, and protect corporate records. As data traffic performance requirements continue to increase, from 4 Gbps and 8 Gbps standards today, to 16 Gbps and higher for future standards, the physical infrastructure must support these demands.

Ensuring high performance requires a complete systems approach to optical transceiver and fiber optic media selection, connectivity choice, channel design and headroom considerations. Panduit's comprehensive suite of fiber optic media and SAN infrastructure products exceed current fiber optic standards and are future-ready using Beyond the GlassSM Design Excellence.

Our storage networking infrastructure solutions are comprised of modular components and high-density patching for maximum agility and scalability over the life of the data center. All system components work together and feature common form factors, accessories, cable routing, and mounting methods so that any component of the physical infrastructure can be easily replicated or utilized elsewhere in the system:

- High-density patch fields with higher port counts accommodate more storage networking connectivity in the same physical space, optimizing equipment rack utilization and conserving valuable data center real estate.
- Best practices for cable management, equipment racking, distribution area layout, pathway routing, and installation techniques ensure infrastructure agility – speed to deploy, increased installer productivity, efficient maintenance, and fast response to changes – in an area where “no down time” is the operating norm.

Ultimately, our fiber research, manufacturing, and solutions development expertise ensure consistent high performance and reliability throughout the storage networking infrastructure.



PRE-TERMINATED COPPER AND FIBER SOLUTIONS

The ability to deploy cabling quickly with minimal system downtime and maximum reliability is key to efficient design and deployment of the physical infrastructure. An end-to-end pre-terminated, factory-tested cabling system is an ideal alternative to traditional cable installation, termination, and testing.



The QuickNet™ Pre-Terminated Cabling System assures quick “plug-in” network deployment and consistent performance while minimizing rework and scrap. Components are precision engineered as part of a complete structured cabling system, connecting switches, servers, and storage equipment via organized patch fields and distribution areas and enabling quick installation in both new and existing facilities. As a result, data centers can handle changing requirements faster and more efficiently than ever before.



The QuickNet™ Copper Cabling System is engineered for maximum design flexibility and high rack density utilization and offers 100% factory-tested pre-terminated cable assemblies in standard and custom lengths and configurations. The QuickNet™ Plug Pack Assemblies facilitate quick and easy connection and disconnection of patch cords to a variety of switches, reducing time and cost associated when installing and maintaining structured cabling links.

The QuickNet™ Fiber Optic Cabling System exceeds the requirements of IEEE 802.3ae 10 GbE and all high-speed ANSI Fibre Channel standards. QuickNet™ Cassettes and Trunk Cable Assemblies and new QuickNet™ SFQ Series Cassettes and Cable Assemblies offer maximum deployment flexibility in QuickNet™ Cassette Enclosures or Patch Panels. These fiber cabling components utilize duplex SC, LC, or MTP* multi-fiber array connectors for high-density, consistent performance, and high reliability. QuickNet™ Copper and Fiber Cassettes are interchangeable for interoperability and future upgrade options within the data center and telecommunications rooms.

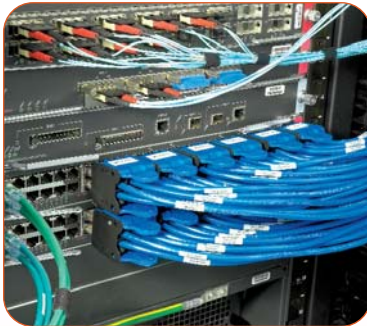

Invest in a trouble-free, high performance infrastructure that leverages reliable, scalable QuickNet™ Pre-Terminated components to ensure consistent, dependable system performance with the lowest cost of ownership.

*MTP is a registered trademark of US Conec Ltd.

FASTER IMPLEMENTATION WITH PRE-CONFIGURED PHYSICAL INFRASTRUCTURES

As more businesses are adopting consolidation, virtualization, and automation of IT assets to drive business results, the physical infrastructures needed to support the technologies that make this happen are increasingly more critical to network performance, more complicated to design, and take longer to implement.

Pre-Configured Physical Infrastructures are based on proven reference designs that map the logical architecture to the physical layer. These solutions are pre-engineered, tested, and validated to lower the infrastructure speed to deployment, enhance thermal performance, decrease energy usage, and reduce total cost of ownership (TCO), resulting in reduced risk and increased sustainability.

At the core of the Pre-Configured Physical Infrastructure offering are solutions tailored for the most popular Cisco Catalyst, Nexus, and UCS deployments. They include all necessary systems, pre-configured within Panduit cabinets, to rapidly deploy various technology platforms, including:

- Thermal Management
- High Speed Data Transport (HSDT) Copper and Fiber Cabling
- Cable Management
- Grounding and Bonding
- Power Outlet Units (POUs)
- Identification Labels

Panduit Pre-Configured Physical Infrastructures arrive at partner or end user sites ready to be deployed, reducing the time required for planning, designing, procurement, and installation. Packaging and transportation waste that would typically occur when specifying individual components is reduced improving sustainability.

To enable business growth and agility across the entire offering, Panduit Pre-Configured Physical Infrastructures are designed to support various network and compute densities. Modular components such as the QuickNet™ Pre-terminated Cabling System facilitate migration from 10G to 40G or 100G Ethernet with minimum investment and down time.

Leveraging Pre-Configured Physical Infrastructures with comprehensive Smart Data Center Solutions, Advisory Services, and an eco-system of partners, Panduit helps to ensure that partner technology platforms are aligned and integrated with the entire data center infrastructure for true optimization.

^Cisco is a registered trademark of Cisco Technology, Inc.





NETWORK GROUNDING AND BONDING

The network grounding and bonding system is more than just an insurance policy against a lightning strike. It is an active, functioning system that mitigates risk throughout the enterprise by providing crucial protection to equipment and personnel. Proper grounding is essential for efficient network system performance. Improper grounding can result in failures such as lower data transmission rates, unacceptable downtime, damaging expensive equipment and voiding equipment warranties.

Data center grounding is governed by documents TIA-942, TIA-607-B, and IEEE Std 1100 (IEEE Emerald Book). According to these standards, a properly designed grounding system is one that is intentional, visually verifiable, adequately sized to handle expected currents safely and one that directs these potentially damaging currents away from sensitive communication equipment.

Panduit offers end-to-end solutions to meet customer needs and today's critical application requirements for grounding data centers. Panduit[®] StructuredGround™ Grounding System provides a high quality, visually verifiable, and dedicated grounding path to maintain system performance, improve network reliability, and protect network equipment and personnel. Highest reliability is ensured; this grounding system meets all applicable grounding and bonding industry standards. Panduit[®] StructuredGround™ Grounding System gives you what you need to properly protect your investment.

PHYSICAL SECURITY

The network infrastructure provides the applications, support, services, and security necessary to enable agility throughout the organization. It is critical that network security and protection guard against unauthorized access to reduce downtime, prevent vandalism or abuse to system components, and help ensure lowest cost of ownership.

Panduit physical security products reduce risk throughout the physical infrastructure and help organizations maintain secure control of sensitive or confidential information.

- Keyed LC Fiber Optic System incorporates positive/negative keying features and color-coding for effective physical layer security; keyed and color-coded connectors prevent unauthorized moves or changes in patch fields and at workstations
- TX6® 10Gig™ Shielded Copper Cabling reduces electromagnetic and radio frequency interference (EMI/RFI) to improve secure transmission of data between offices, branches, and remote locations
- PanView iQ™ Hardware and Physical Infrastructure Management™ Software is a next-generation physical infrastructure management system that provides real-time monitoring of patch field connectivity to enable quick detection of unintended or improper patch field changes
- RJ45 jack blockout devices, RJ45 plug lock-in devices, and USB blockout devices provide simple and secure methods to secure connections, control access to data, and deter vandalism to jacks-saving time and money associated with downtime, data security breaches, hardware replacement, and infrastructure repair
- LC Fiber Optic Duplex Adapter Blockout Device is a tamper-resistant design which blocks unauthorized access to LC duplex ports. The LC Fiber Optic Lock-In Duplex Clip prevents unauthorized removal of cable and secures connections. The products work to reduce network downtime, data security breaches, and hardware replacement due to theft.
- PanZone® Zone Cabling Enclosures for ceiling, wall mount and in-floor applications offer lockable features to protect against tampering, theft, or other physical abuse to network connections and cables

Whether in the data center, telecommunications rooms, factory floor or work area, Panduit creates innovative solutions that improve security for both data and equipment within the physical infrastructure, ensuring that only authorized individuals have access to building management systems and network devices.



Pages with this icon are part of physical security.

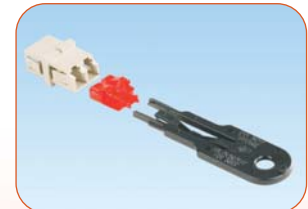
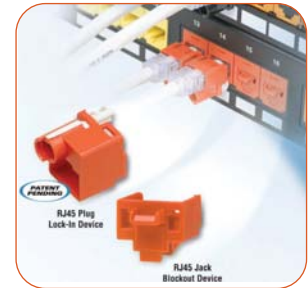



ENTERPRISE SOLUTIONS

Enterprises today require the spaces they occupy to be supported by a wide variety of business systems and communication technologies. Traditional control systems for lighting, security, HVAC, and energy management must now co-exist with IP-based voice, data, and video communication technologies.

Enterprise solutions link facility and network systems directly into the converged building network, generating and sharing data over a single platform to enhance the efficiency and effectiveness of the building as a whole. These solutions are based on running network cabling within shared pathways in order to extend the reach of a physically converged infrastructure to all devices and systems.

Most systems can be physically converged through shared conduit, cable trays, and building pathways; while logically they will converge through a switched IP network. This converged design allows building systems to be considered a true business asset, helping manage risk across the enterprise by:

- Reducing capital expenses by managing installation design and contracting
- Reducing operational expenses through efficient moves, adds, and changes
- Employing a scalable and smart infrastructure that supports TIA/EIA-568 and -569 telecommunications cabling standards
- Enabling greater occupant productivity, safety, and comfort while maintaining the building value over time

The unified approach results in a reliable, interoperable, and scalable physical infrastructure that enables the deployment of converged applications throughout a building to improve manageability, lower total cost of ownership, and ultimately minimize risk.

MULTI-DWELLING/MULTI-TENANT UNIT MEDIA SERVICES

Multi-dwelling units and/or multi-tenant units (MDU/MTU) consist of buildings with multiple floors and units designated for residential (complexes, apartments, and condominiums) or commercial use (hotels, office complexes, and retail buildings). Individuals occupying these spaces are increasingly demanding access to the latest multimedia communications with the ability for customization.

The Panduit media distribution system allows contractors and building owners to provide end-to-end voice, video, and data systems to their customers by consolidating all incoming communication cable from the building's entry point to a centralized high-density enclosure installed within each unit (typically in a utility or closet). The enclosure uses innovative hubs to distribute these triple play services to individual outlets enabling unique, customer-defined communication access to every room or office of the unit. As needs change, each occupant may easily modify services using modular hubs and high density features that support a greater number of media connections within the enclosure. As a result, the Panduit media distribution system delivers maximum use of space and greater service flexibility while maintaining aesthetics.

From the building demarcation point to the end user's network outlet, the Panduit media distribution system is the most flexible and comprehensive solution for distributing triple play services in support of today's applications and tomorrow's opportunities.

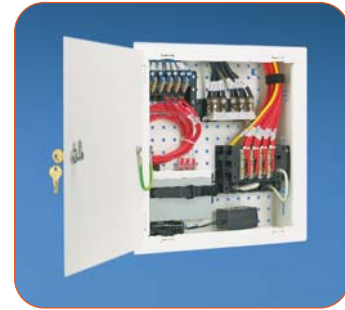

WIRELESS SOLUTIONS

Since the release of the IEEE 802.11 set of standards, wireless access to data and the Internet has grown in popularity and has contributed to the tremendous growth in the use of WLANs (wireless local area networks) to deliver freedom and mobility to users accessing Ethernet networks. Integrated wired and wireless networks have become essential elements of successful enterprise environments, and are rapidly becoming necessities throughout college campuses, hospitals, convention centers, hotels, and ancillary facilities.

Panduit has collaborated with Cisco Systems to deliver a complete wireless enclosure solution. This solution cost-effectively addresses network deployment, security, and aesthetics by bringing together wired and wireless networks to enable complete interoperability. Integrated networks reduce complexities associated with operating and maintaining devices across multiple environments.

Complementing Cisco System's Integrated Wireless Network are Panduit physical infrastructure solutions. Designed specifically to support a secured wired and wireless environment, Panduit copper and fiber cabling and connectivity systems, wireless access point enclosures, and Power over Ethernet patch panels provide a reliable platform to ensure the most robust and secure enterprise LAN possible.

The Panduit wireless connection delivers proven interoperability that helps ensure reliability and performance throughout the enterprise LAN. End-users deploying an integrated wired and wireless network are able to maximize their network investment by extending their network applications throughout the enterprise in a reliable and cost-effective manner.



ULTIMATE ID® NETWORK LABELING

Permanent labeling is critical for all network cabling system installations. Proper labeling and identification of the physical infrastructure enhances the visibility of all network elements; reduces the time to make moves, adds, and changes; and contributes toward a safer network and data center environment.

Panduit® Ultimate ID® Network Labeling Solutions provide clean and efficient labeling of the network physical infrastructure in accordance with TIA/EIA-606-B. The Ultimate ID® system standardizes on a common label height across all Ultimate ID® products and supports Mini-Com® products (faceplates, surface mount boxes, patch panels) across your installation:

- All labels are protected by a tamper-resistant transparent plastic cover to protect the legend
- All labels are positioned adjacent to, centered on, and parallel to the port they are identifying
- All labels have the same compact height to enhance the appearance of the installation
- All labels are made of a durable, multi-layered, non-adhesive construction that makes installation and removal quick and easy
- The label cover surface is flush with the adjacent faceplate surface

Ultimate ID® Labeling Solutions are available for a variety of printers, including desktop, as well as the Panduit® PanTher™ LS8E and Cougar™ LS9 Hand-Held Thermal Transfer Printers. The PanTher™ LS8E Printer makes compliant labeling fast and easy. Built-in programming lets you line up your legends on patch panel and faceplate labels without guessing how many spaces are needed, which makes the PanTher™ LS8E Printer the best solution for on-site network connectivity labeling.

Ultimate ID® Labeling Software for WINDOWS^ is designed for fast and easy creation of labels for Ultimate ID® Network System patch panels, faceplates, surface mount boxes and marker ties. Ultimate ID® Labeling Software for WINDOWS^ is included with all ID labeling solutions.

^WINDOWS is a registered trademark of Microsoft Corp. in the United States and/or other countries.



WORKSTATION AREA ROADMAP

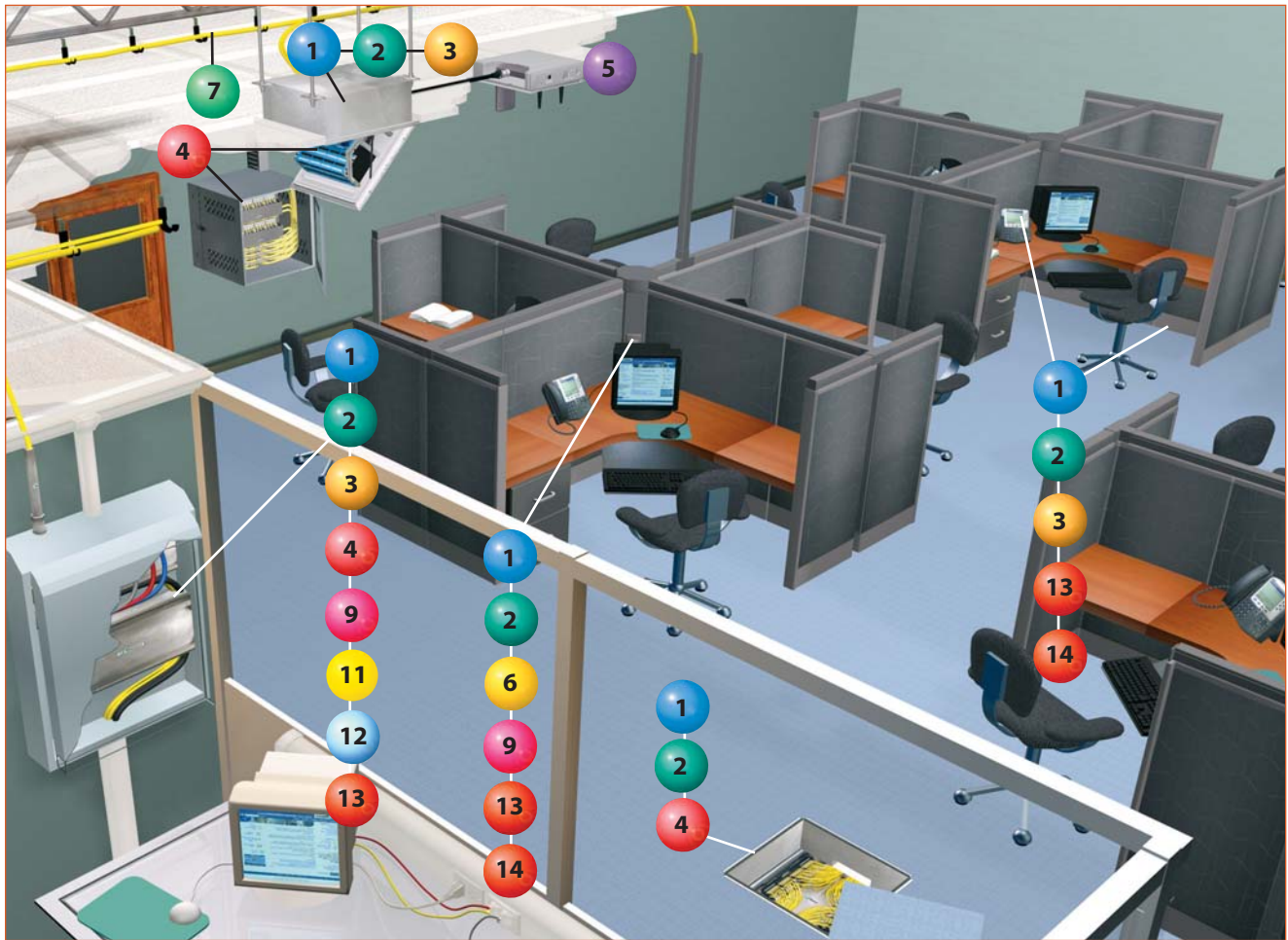

1 Copper Systems (pages B.1 – B.98)



4 Zone Cabling (pages E.1 – E.10)



2 Fiber Optic Systems (pages C.1 – C.106)



5 Wireless (pages F.1 – F.5)



3 Power over Ethernet (pages D.1 – D.6)



6 Outlets (pages G.1 – G.30)



ULTIMATE ID

7 Physical Infrastructure Management (pages I.1 – I.12)



TELECOMMUNICATIONS ROOM ROADMAP

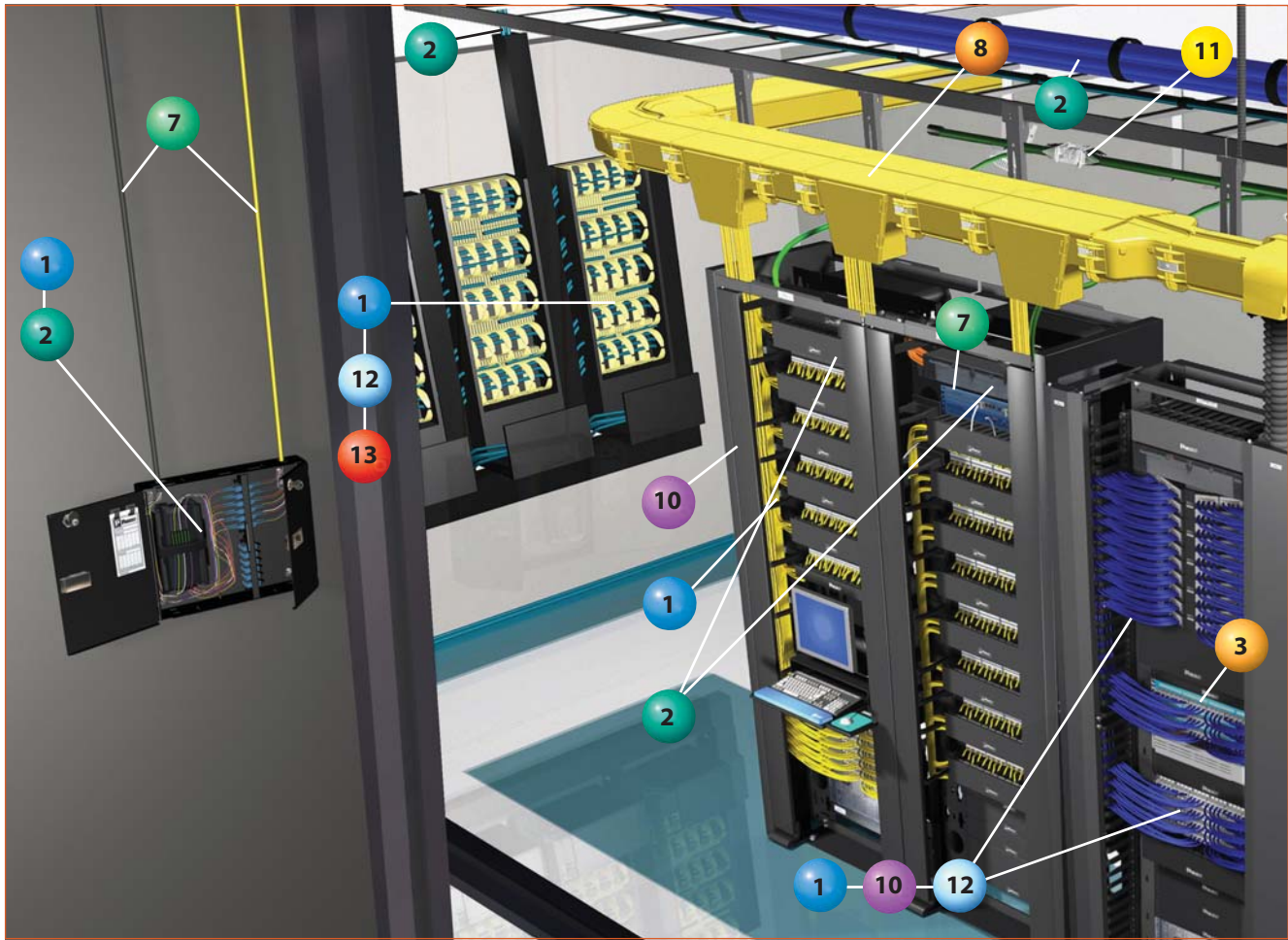

8 Overhead and Underfloor Routing (pages J.1 – J.80)



11 Grounding and Bonding (pages M.1 – M.58)



9 Surface Raceway (pages K.1 – K.26)



12 Labeling and Identification (pages O.1 – O.30)



10 Cabinets, Racks, and Cable Management (pages L.1 – L.100)



13 Cable Management Accessories (pages P.1 – P.46)



14 Abrasion Protection (pages P.47 – P.52)



DATA CENTER ROADMAP

1 Copper Systems
(pages B.1 – B.98)



2 Fiber Optic Systems
(pages C.1 – C.106)



3 Power over Ethernet
(pages D.1 – D.6)



4 Zone Cabling
(pages E.1 – E.10)



5 Cabinets,
Racks, and
Cable Management
(pages L.1 – L.100)

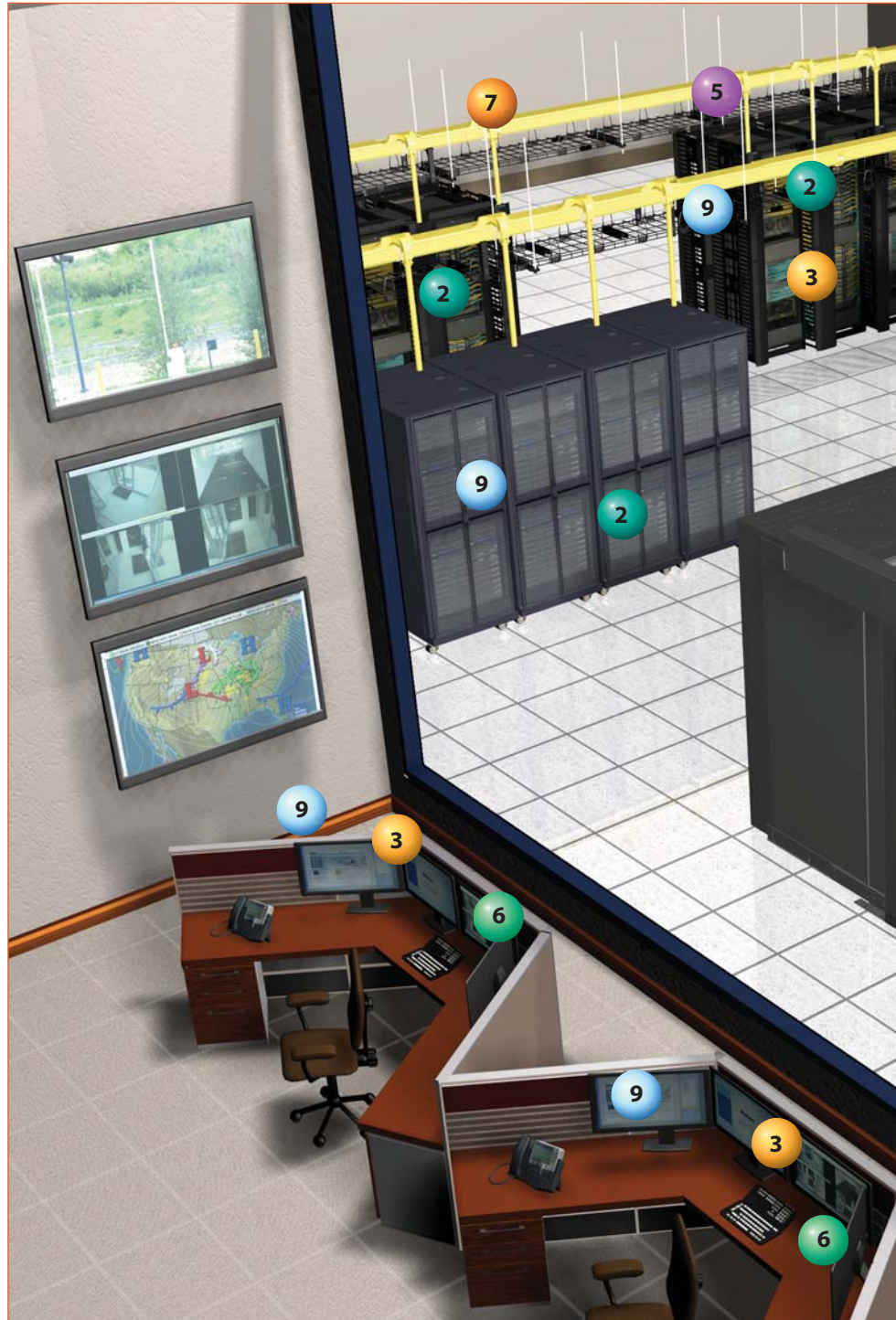



6 Physical Infrastructure Management (pages I.1 – I.12)



7 Overhead and Underfloor Routing (pages J.1 – J.80)



8 Grounding and Bonding (pages M.1 – M.58)



9 Labeling and Identification (pages O.1 – O.30)



10 Cable Management Accessories (pages P.1 – P.46)



TX COPPER SYSTEMS SELECTION GUIDE

Panduit offers end-to-end cabling system solutions for copper and fiber cabling applications. Panduit cabling systems provide a complete, high performance, reliable, synergized structured cabling infrastructure to optimize your network performance while providing one point of contact.

	Panduit® TX6A™ Systems	Panduit® TX6500™ Systems	Panduit® TX6000™ Systems	Panduit® TX5500™ Systems
Standards	<ul style="list-style-type: none"> ANSI/TIA-568-C.2 Category 6A ISO/IEC 11801 Edition 2, Amendment 1 Class E_A 	<ul style="list-style-type: none"> ANSI/TIA-568-C.2 Category 6 ISO/IEC 11801 Edition 2 Class E TSB-155 Supports 10GBASE-T applications up to 37 meter channels 	<ul style="list-style-type: none"> ANSI/TIA-568-C.2 Category 6 ISO/IEC 11801 Edition 2 Class E TSB-155 Supports 10GBASE-T applications up to 37 meter channels 	<ul style="list-style-type: none"> ANSI/TIA-568-C.2 Category 5e ISO/IEC 11801 Edition 2 Class D
Performance (Bandwidth)	>500 MHz	>350 MHz	>300 MHz	>175 MHz
Applications	<ul style="list-style-type: none"> Ethernet 10GBASE-T, 100BASE-T, 1000BASE-T (Gigabit Ethernet), 10GBASE-T Data center applications for switch-to-switch links, storage area networks, computer cluster farms, storage on demand, and aggregation of data Vital business management applications, scientific modeling, work group file transfer and media rendering Web-enabling applications such as Voice over Internet Protocol (VoIP) and live video/audio broadcasting Power over Ethernet (PoE) 	<ul style="list-style-type: none"> Ethernet 10BASE-T, 100BASE-T (Fast Ethernet), 1000BASE-T (Gigabit Ethernet), 10GBASE-T (10 Gigabit Ethernet over limited distances as specified in the industry 10GBASE-T standards) 155 Mb/s ATM, 622 Mb/s ATM, 1.2 Gb/s ATM Token Ring 4/16 Voice/data systems Voice over Internet Protocol (VoIP) Power over Ethernet (PoE) 	<ul style="list-style-type: none"> Ethernet 10BASE-T, 100BASE-T (Fast Ethernet), 1000BASE-T (Gigabit Ethernet), 10GBASE-T (10 Gigabit Ethernet over limited distances as specified in the industry 10GBASE-T standards) 155 Mb/s ATM, 622 Mb/s ATM, 1.2 Gb/s ATM Token Ring 4/16 Voice/data systems Voice over Internet Protocol (VoIP) Power over Ethernet (PoE) 	<ul style="list-style-type: none"> Ethernet 10BASE-T, 100BASE-T (Fast Ethernet), 1000BASE-T (Gigabit Ethernet), 155 Mb/s ATM, 622 Mb/s ATM, 1.2 Gb/s ATM Token Ring 4/16 Voice/data systems Voice over Internet Protocol (VoIP) Power over Ethernet (PoE)
Pre-Terminated Connectivity	QuickNet™ Copper Cabling System (pages B.8 – B.13)	QuickNet™ Copper Cabling System (pages B.8 – B.13)	QuickNet™ Copper Cabling System (pages B.8 – B.13)	QuickNet™ Plug Pack Assemblies (pages B.10 – B.11)
	QuickNet™ Plug Pack Assemblies (pages B.10 – B.11)	QuickNet™ Plug Pack Assemblies (pages B.10 – B.11)	QuickNet™ Plug Pack Assemblies (pages B.10 – B.11)	
Cable	TX6A™ and TX6A-SD™ 10Gig™ Copper Cable with MaTriX Technology (page B.19)	TX6500™ Enhanced Category 6 UTP Copper Cable (page B.26)	TX6000™ Category 6 UTP Copper Cable (page B.27)	TX5500™ Category 5e UTP Copper Cable (page B.39)
Jack Modules	Mini-Com® TX6™ 10Gig™ Jack Modules (pages B.16 and B.20)	Mini-Com® TX6™ PLUS Jack Modules (page B.28)	Mini-Com® TX6™ PLUS Jack Modules (page B.28)	Mini-Com® TX5e™ Jack Modules (page B.40)
Patch Panels	DP6A™ 10Gig™ Patch Panels (page B.22)	DP6™ PLUS Patch Panels (page B.31)	DP6™ PLUS Patch Panels (page B.31)	DP5e™ Patch Panels (page B.43)
Patch Cords	TX6A™ and TX6A-SD™ 10Gig™ Patch Cords with MaTriX Technology (page B.19)	TX6™ PLUS Patch Cords (page B.34)	TX6™ PLUS Patch Cords (page B.31)	TX5e™ Patch Cords (page B.46)
Punchdown Systems	—	GP6™ Punchdown System (pages B.76 – B.82)	GP6™ Punchdown System (pages B.76 – B.82)	Pan-Punch® 110 Category 5e Punchdown System (pages B.84 – B.91)

FIBER OPTIC SYSTEMS SELECTION GUIDE

	Panduit Multimode Systems			Panduit Singlemode Systems
	OM3/OM4 10Gig™ 50µm	OM2 50µm	OM1 62.5µm	OS1/OS2 9µm
Standards	<ul style="list-style-type: none"> IEEE 802.3z 1GBASE-SX – 850nm IEEE 802.3ae 10GBASE-S – 850nm 10GBASE-LX4 – CWDM 1,2,4,8,10 and 16 Gigabit Fibre Channel, (FC-x00-M5*-SN-I, and 10GFC 1200); x = 1, 2, 4, 8, 12, and 16 * = E (OM3) or F (OM4) x = 1,2,4,8,12 and 16 InfiniBand (IB-xX-yDR-SX); x = 1, 4, 8, 12 lanes; y = S, D, Q (Single, Double, Quadruple data rates) SONET OC-192/SDH STM-64, (OIF VSR4-04) 	<ul style="list-style-type: none"> IEEE 802.3j 10BASE-F – 850nm IEEE 802.3u 100BASE-FX – 850nm IEEE 802.3z 1GBASE-SX – 850nm IEEE 802.3ae 10GBASE-S – 850nm 10GBASE-LX4 – CWDM 1, 2, 4 Gigabit Fibre Channel, (FC-x00-M5-SN-I); x = 1, 2, 4 InfiniBand (IB-xX-yDR-SX); x = 1, 4, 8, 12 lanes; y = S, D, Q (Single, Double, Quadruple data rates) 	<ul style="list-style-type: none"> IEEE 802.3j 10BASE-F – 850nm IEEE 802.3u 100BASE-FX – 850nm IEEE 802.3z 1GBASE-SX – 850nm IEEE 802.3ae 10GBASE-S – 850nm 10GBASE-LX4 – CWDM 1, 2, 4 Gigabit Fibre Channel, (FC-x00-M5-SN-I); x = 1, 2, 4 InfiniBand (IB-xX-yDR-SX); x = 1, 4, 8, 12 lanes; y = S, D, Q (Single, Double, Quadruple data rates) 	<ul style="list-style-type: none"> IEEE 802.3z 1GBASE-LX – 1310nm IEEE 802.3ae: 10GBASE-LX4 – CWDM 10GBASE-LX – 1310nm 10GBASE-EX – 1550nm InfiniBand (IB-xX-yDR-LX); x = 1, 4 lanes; y = S, D, Q (Single, Double, Quadruple data rates) SONET OC-192 and OC-768
Bandwidth (EMBc in MHz.km)	<ul style="list-style-type: none"> Standard reach fiber: OM3>2000 Extended reach fiber: OM4>4700 	<ul style="list-style-type: none"> Standard reach fiber: >510 Extended reach fiber: >950 	>220	N/A
Reach (@850nm)	<ul style="list-style-type: none"> Standard reach OM3 fiber: up to 1000m (1GBASE-SX); up to 300m (10GBASE-S); up to 300m (10GBASE-LX4) Extended reach OM4 fiber: up to 1040m (1GBASE-SX); up to 550m (10GBASE-S) 	<ul style="list-style-type: none"> Standard reach OM2 fiber: up to 600m (1GBASE-SX); up to 82m (10GBASE-S); up to 240m (10GBASE-LX4) Extended reach OM2 fiber: up to 750m (1GBASE-SX); up to 150m (10GBASE-S) 	<ul style="list-style-type: none"> OM1 fiber: up to 300m (1GBASE-SX); up to 33m (10GBASE-S); up to 300m (10GBASE-LX4) 	<ul style="list-style-type: none"> OS1/OS2 fiber: up to 5km (1GBASE-LX); up to 10km (10GBASE-LX4); up to 10km (10GBASE-LX); up to 40km (10GBASE-EX)
Applications	<ul style="list-style-type: none"> Data centers (switch-to-switch horizontal links)and storage area networks Financial and medical applications; data warehousing High performance computing – scientific modeling, simulation and Bioninformatics 	<ul style="list-style-type: none"> Building backbones and zone cabling Fiber to the enclosure – delivery of high bandwidth to workgroup applications Fiber to the desk – digital content creation and video file transaction 	<ul style="list-style-type: none"> Legacy building backbones and zone cabling Fiber to the enclosure – delivery of high bandwidth to workgroup applications Fiber to the desk – digital content creation and video file transaction 	<ul style="list-style-type: none"> Campus and building backbones Entrance facilities and equipment rooms Carrier equipment applications “Dark fiber” enterprise applications
Cable	Opti-Core® Fiber Optic Cable			
	10Gig™ OM3/OM4 Multimode (pages C.4 – C.18)	OM2 Multimode (pages C.4 – C.18)	OM1 Multimode (pages C.4 – C.18)	OS1/OS2 Singlemode (pages C.4 – C.18)
Fiber Optic Connectors	OptiCam® Pre-Polished Cam, Opti-Crimp® Pre-Polished Crimp, and Field Polish Connectors			
	Multimode LC, Keyed LC, and SC (pages C.19 – C.27)	Multimode LC, Keyed LC, SC, ST, and FJ® (pages C.19 – C.27)	Multimode LC, Keyed LC, SC, ST, and FJ® (pages C.19 – C.27)	Singlemode LC, Keyed LC, SC, ST, and FJ® (pages C.19 – C.27)
Adapters, Adapter Modules, and Fiber Adapter Panels	Fiber Optic Adapters, Mini-Com® Fiber Optic Adapter Modules, and Opticom® Fiber Adapter Panels			
	10Gig™ OM3/OM4 Multimode MPO/MTP*, LC, Keyed LC, and SC (pages C.28 – C.43)	OS1 Multimode MPO/MTP*, LC, Keyed LC, SC, ST, and MT-RJ (pages C.28 – C.43)	OM1 Multimode MPO/MTP*, LC, Keyed LC, SC, ST, and MT-RJ (pages C.28 – C.43)	OS1/OS2 Singlemode MPO/MTP*, LC, Keyed LC, SC, ST, and FC (pages C.28 – C.43)
Pre-Terminated MTP* Cassettes	QuickNet™ SFQ Series and QuickNet™ MTP* Cassettes			
	10Gig™ OM3/OM4 Multimode (pages C.44 – C.53)	OM2 Multimode (pages C.44 – C.53)	OM1 Multimode (pages C.44 – C.53)	OS1/OS2 Singlemode (pages C.44 – C.53)
Enclosures, Trays, Patch Panels, and Accessories	QuickNet™ and Opticom® Enclosures, Trays, and Patch Panels and Mini-Com® Patch Panels			
	(pages C.54 – C.62)	(pages C.54 – C.62)	(pages C.54 – C.62)	(pages C.54 – C.62)
Patch Cords, Pigtails, Reference Cable Assemblies, and Kits	Opti-Core® Fiber Optic Patch Cords, Pigtails, and Reference Cable Assemblies and Kits			
	10Gig™ OM3/OM4 Multimode LC, Keyed LC, and SC (pages C.63 – C.90)	OM2 Multimode LC, Keyed LC, SC, ST, and FJ® (pages C.63 – C.90)	OM1 Multimode LC, Keyed LC, SC, ST, and FJ® (pages C.63 – C.90)	OS1/OS2 Singlemode LC, Keyed LC, SC, ST, and FJ® (pages C.63 – C.90)
Hydra, Interconnect, and Trunk Cable Assemblies	QuickNet™ Hydra, Interconnect, MTP* Trunk, and Traditional Trunk Cable Assemblies			
	10Gig™ OM3/OM4 Multimode (pages C.91 – C.100)	OM2 Multimode (pages C.91 – C.100)	OM1 Multimode (pages C.91 – C.100)	OS1/OS2 Singlemode (pages C.91 – C.100)
Termination Kits and Tools	OptiCam® and Field Polish Connector Termination Kits and Tools			
	(pages C.101 – C.106)			

*MTP is a registered trademark of US Conec Ltd.



RoHS

GLOBAL SERVICES AND SUPPORT

Panduit maintains a dedicated global sales force of highly qualified industry experts to provide professional, consultative sales guidance. In addition, partnership with Panduit Certified Installers, Designers, and System Integrators offers assistance from design through implementation and post-sale support. Panduit also teams with best-in-class partners to deliver interoperable, open architecture solutions. Combined, these partnerships provide the services and support to deliver comprehensive, reliable solutions and reduce the total cost of ownership.

ENVIRONMENTAL POLICY

Panduit embraces green thinking as a core value. As a global manufacturer, our mission is to design facilities and products for the present generation without compromising the ability of the future generations to meet their needs. Our company-wide commitment has resulted in the long-standing deployment of programs throughout our global facilities that use energy efficiently, reduce energy consumption, and minimize our ecological footprint.

Specifically, Panduit is committed to the prevention of pollution through compliance with applicable legal requirements and continuous improvement of our environmental performance. This policy is implemented through a mature and effective environmental management system (EMS) that includes planning, training, measurement, reporting, and review. Panduit is also committed to being a good corporate neighbor by engaging in global long-term sustainability initiatives that protect, replenish, and restore the communities in which we live and operate.

We communicate our green philosophy throughout the industry as an active participant of the U.S. Green Building Council, developers of the LEED Green Building Rating System; The Green Grid, a global consortium dedicated to advancing the energy efficiency of data centers and business computing ecosystems worldwide; and the NEMA "Call to Action" steering committee, which is dedicated to limiting the use of hazardous materials in electrical products.

RESTRICTION OF HAZARDOUS SUBSTANCES (RoHS)

Applicable Panduit products comply with the material restrictions of European directives on the *Restriction of Hazardous Substances* (RoHS; 2002/95/EC) and *Waste Electrical and Electronic Equipment* (WEEE; 2002/96/EC). All global Panduit manufacturing facilities are registered to the *ISO 14001:2004* and *ISO 9001:2000* standards, and we are currently working towards compliance with REACH regulations (Registration, Evaluation, Authorization, and Restriction of Chemicals) passed by the European Union in 2007.

PANDUIT BUSINESS PARTNER PROGRAM

In an era where differentiation is demanded, the Panduit Business Partner Program enhances our partners' productivity, profitability, and business growth by focusing on the design, development, marketing, delivery, and maintenance of Panduit solutions.

Panduit is committed to providing our partners with the tools and resources necessary to successfully deliver Panduit solutions through the entire customer lifecycle: consulting, planning, design, deployment, implementation, operation, and maintenance. The Business Partner Program leverages Panduit's Unified Physical InfrastructureSM (UPI) approach to help partners enhance their business offering – from hardware and software to services and solutions – and deliver maximum customer value.

Increased Business Capabilities: Panduit's top partners are certified to deliver Panduit solutions that improve customer capabilities while increasing operational efficiency. A wide range of partners across multiple disciplines are available to help you increase revenue and drive new business efficiencies.

Increased Differentiation: Enjoy strategic advantage over your competition by working with partners that understand Panduit solutions and product systems technologies. Utilize Panduit's UPI-based solutions to enrich and specialize your data center, enterprise, and industrial automation offerings, optimizing your core business systems while driving resource and energy efficiencies across the physical infrastructure.

Enhanced Customer Relevance: In a dynamic business environment, customers value a wide breadth of capabilities that can be leveraged to increase business agility now while managing risk into the future. As you work with Panduit partners, your success will increase as your physical infrastructure capabilities grow.

Panduit Business Partner skill sets range from electrical and networking to IT, consulting, architecting, engineering, and design. Training and certifications earned by partners enable them to share the best practices and lessons learned in physical infrastructure environments, and then pass this increased knowledge and expertise to customers.

Overall this comprehensive program addresses key needs across critical physical infrastructure systems to increase partner differentiation and enhance relevance with customers.

B.
Copper
Systems

C.
Fiber
Optic
Systems

D.
Power
over
Ethernet

E.
Zone
Cabling

F.
Wireless

G.
Outlets

H.
Media
Distribution

I.
Physical
Infrastructure
Management

J.
Overhead &
Underfloor
Routing

K.
Surface
Raceway

L.
Cabinets,
Racks &
Cable
Management

M.
Grounding &
Bonding

N.
Industrial

O.
Labeling &
Identification

P.
Cable
Management
Accessories

Q.
Index

PANDUIT DESIGN TOOLS

The Panduit design tools program provides software tools that will speed up the design process and increase the quality of schematic design and construction drawings, IT/end customer drawings, specification and RFQs, utilizing Panduit products wherever possible.

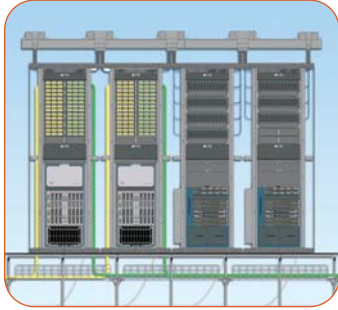

These design tools allow a quick design of a data center or telecommunications room for a customer, allowing them to see a visual representation of that data center utilizing Panduit product. These visual representations can be in either 2D or 3D based on the designer's expertise and/or software configuration.

PANDUIT PROFESSIONAL SERVICES

Panduit Professional Services ensures that the foundation on which your systems function is reliable and operationally efficient, so that you can focus on the maximizing value to your top-of-mind business objectives. Our primary objective is to help you identify and minimize the risk of physical layer issues by providing integrated services and solutions built around your business needs and fully integrated with your system's architecture.



Panduit methodology-based approach defines the most critical elements to minimize operational risk, maximize return on investment, and build a reliable physical infrastructure for any system deployment. Combining our global collaboration and delivery model with our network of skilled partners, we are able to deliver consistent, best-in-class physical infrastructure, anywhere in the world.

COPPER SYSTEMS

Panduit offers end-to-end solutions for all twisted pair copper cabling applications. TX™ Copper Cabling Systems provide reliable network performance for the most demanding high-speed and bandwidth-demanding applications while exceeding the latest industry standards. Mini-Com® Modules are interchangeable within Panduit modular patch panels, faceplates, and surface mount boxes to provide modular solutions for intermediate to high-density installations. A variety of colors enable color-coding of connectivity for network segregation.

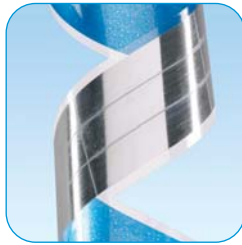
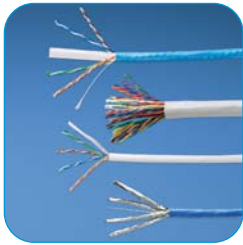

- Pre-terminated solution can be installed in 75% less time than field-terminated installations, eliminating the need for on-site bundling, terminating, and testing
- Plug pack assemblies facilitate quick and easy connection and disconnection of patch cords to a variety of switches, reducing time and cost associated when installing and maintaining active equipment
- Copper cable is designed to be installed with Panduit connectivity products (jack modules, pre-terminated cassettes, patch panels, and patch cords) to provide a reliable, modular, end-to-end solution
- Copper TG Style Jack Modules feature enhanced Giga-TX™ Technology optimizing performance by maintaining cable pair geometry and eliminating conductor untwist; forward motion termination places no impact on critical internal components for maximum reliability
- Patented angled patch panels facilitate proper bend radius control and minimize the need for horizontal cable managers, providing a high-density solution which conserves valuable rack space

The QuickNet™ Copper Cabling System is a pre-terminated solution with standard and custom options, designed to meet data center and enterprise cabling requirements. Fast and simple to install, this high-density solution provides consistent network reliability and reduces on-site rework. TX™ Copper Cabling Systems are available in Category 6A, Category 6, and Category 5e performance levels and include STP and UTP copper cable, jack modules, patch cords and patch panels. Panduit solutions are designed with flexibility to support your growing and changing network requirements.

Copper Systems Roadmap

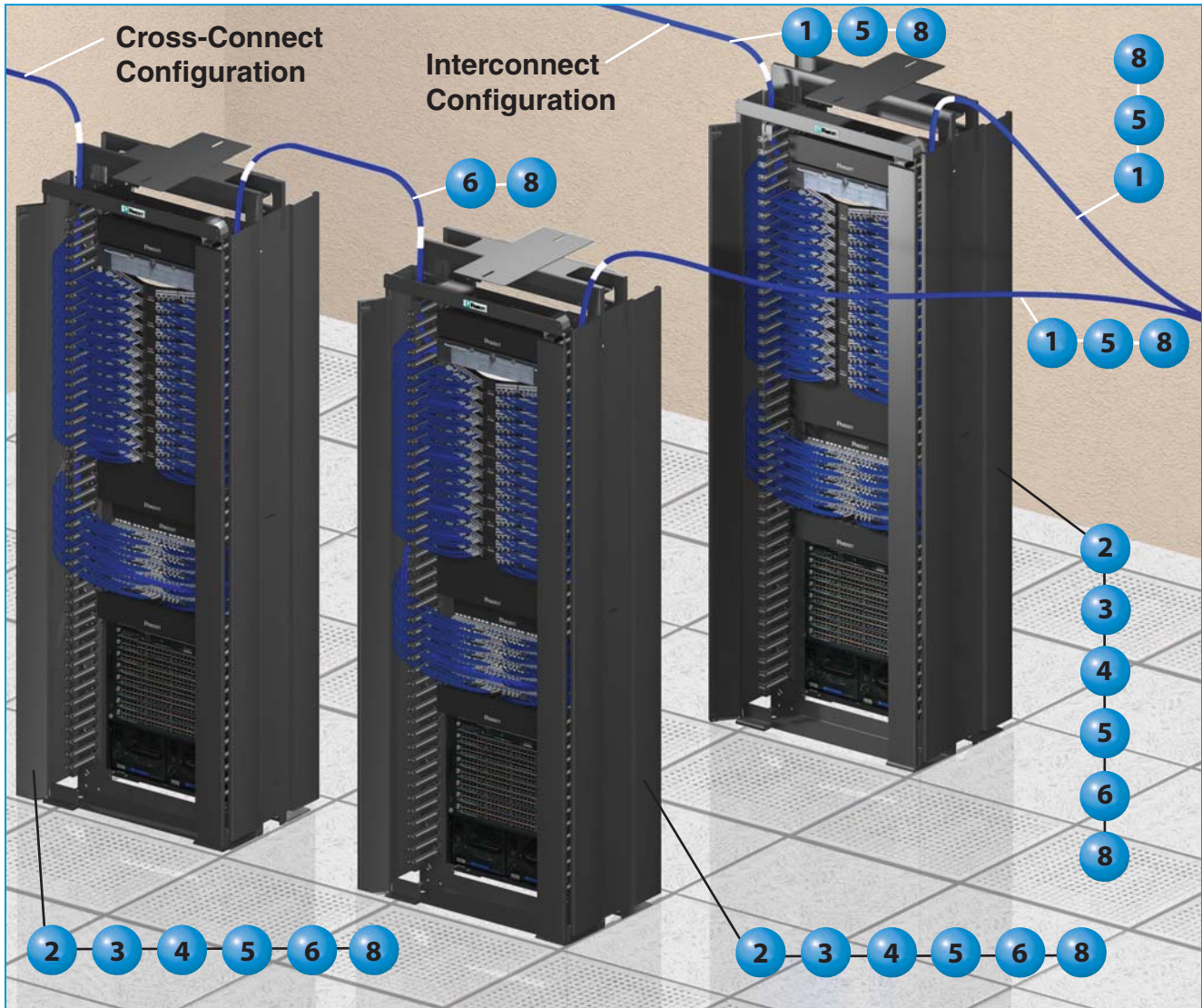

Data Center/Telecommunications Room

1 TX™ Copper Cable
(pages B.14, B.15,
B.19, B.26, B.27, B.39,
B.47, B.52)

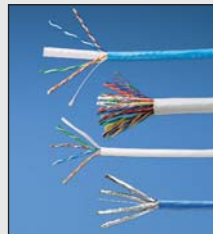

3 Mini-Com® Modular
Patch Panels
(pages B.66 – B.73)

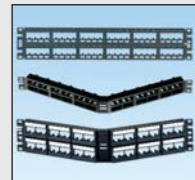

2 Mini-Com® Jack Modules
(pages B.16 – B.17, B.20 –
B.21, B.28 – B.29, B.36 –
B.37, B.40 – B.42, B.48 –
B.49, B.55, B.58 – B.64)





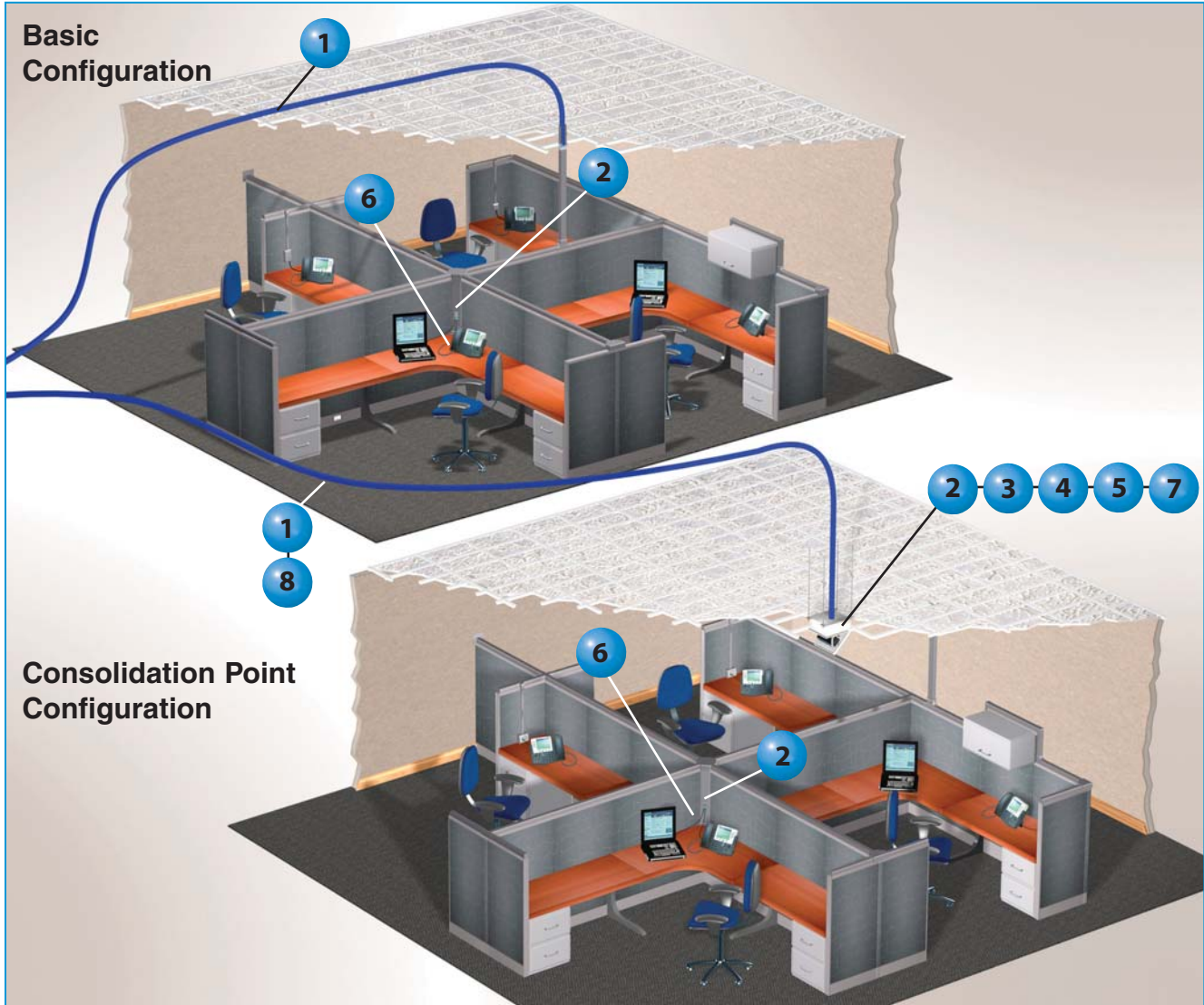

4 Punchdown and Coupler
Patch Panels
(pages B.22, B.24, B.31,
B.33, B.43, B.45, B.53)



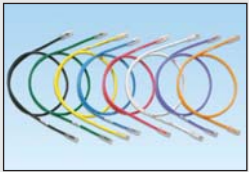

Workstation Area

<p>5 QuickNet™ Copper Cabling System (pages B.8 – B.13)</p>		<p>7 Zone Cabling (pages E.1 – E.10)</p>	
<p>6 Patch Cords (pages B.18, B.25, B.34, B.46, B.50)</p>		<p>8 Grounding and Bonding (pages M.1 – M.58)</p>	

SFP+ 10 Gb/s Direct Attach Passive Cable Assemblies

- Meet SFF-8431, 8432, 8472 industry standards to support 10 Gigabit Ethernet
- Ideal for Top of Rack (ToR) switch to server applications
- Passive connection provides a low cost, short reach interconnect option without additional power requirements
- Constructed with high speed, 2-pair, twinaxial cable, factory terminated to SFP+ 10 Gb/s hot pluggable modular connectors
- 100% performance tested
- Low profile latching mechanism in connector allows assemblies to be installed side by side or stacked on top of each other providing maximum port density in high density installations
- Small diameter cable design enables superior cable management and improved air flow
- Robust strain relief boot provides proper bend radius control for consistent reliability
- Variety of standard lengths allow more precise deployment, improved cable management and cost efficiencies



Part Number	Part Description	Length (m)	AWG Size	Cable Color	Std. Pkg. Qty.	Std. Ctn. Qty.
PSF1PXA1MBU*	High speed twinaxial cable assembly with SFP+ 10Gbps hot pluggable modular connectors on each end.	1	30	Blue	1	10
PSF1PXD4MBU‡	High speed twinaxial cable assembly with SFP+ 10Gbps hot pluggable modular connectors on each end.	4	24	Blue	1	10

*For lengths other than 1 meter (0.5 meters to 3.5 meters, increments of 0.5 meter) change the length designation in the part number to the desired length. For standard cable colors other than Blue, replace suffix BU (Blue) with WH (White) or BL (Black). For example, the part number for a white, 0.5 meter cord is PSF1PXA0.5MWH.

‡ For lengths other than 4 meters (4 to 7 meters, increments of 0.5 meter) change the length designation in the part number to the desired length. For standard cable colors other than Blue, replace suffix BU (Blue) with WH (White) or BL (Black). For example, the part number for a white, 7-meter cord is PSF1PD7MWH.

SFP+ 10 Gb/s Direct Attach Active Cable Assemblies

- Meet SFF-8431, 8432, 8472 industry standards to support 10 Gigabit Ethernet
- Ideal for Top of Rack (ToR) and End of Row (EoR) switch to server applications
- Fibre Channel over Ethernet (FCoE) capable
- Connector contains low power circuitry to extend beyond passive cable assemblies
- Constructed with high speed, 2-pair, twinaxial cable, factory terminated to SFP+ 10Gbps hot pluggable modular connectors
- 100% performance tested
- Low profile latching mechanism in connector allows assemblies to be installed side by side or stacked on top of each other providing maximum port density in high density installations
- Small diameter cable design enables superior cable management and improved air flow
- Robust strain relief boot provides proper bend radius control for consistent reliability
- Variety of standard lengths allow more precise deployment, improved cable management, and cost efficiencies

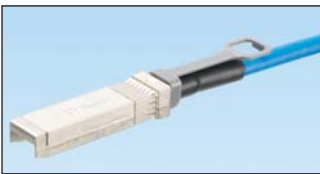

Part Number	Part Description	Length (m)	AWG Size	Cable Color	Std. Pkg. Qty.	Std. Ctn. Qty.
PSF1AXD7MBU*	High speed twinaxial cable assembly with SFP+ 10 Gb/s hot pluggable, active modular connectors on each end.	7	24	Blue	1	10
PSF1AXA3MBU**	High speed twinaxial cable assembly with SFP+ 10 Gb/s hot pluggable modular connectors on each end.	3	30	Blue	1	10

*For lengths other than 7 meter (7 to 15 meters, increments of one meter) change the length designation in the part number to the desired length. For standard cable colors other than Blue, replace suffix BU (Blue) with WH (White) or BL (Black). For example, the part number for a white 10-meter cord is PSF1AXD10MWH.

**Also available in 5 meters. For standard cable colors other than Blue, replace suffix BU (Blue) with WH (White) or BL (Black). The part number for a black 5-meter cord is PSF1AXA5MBL.

QSFP+ 40Gig Direct Attach Copper Cable Assemblies

- Compliant to IEEE 802.3ba and SFF-8436 for use in 40GBASE-CR4 applications
- EEPROM compliant to SFF-8436 ensures interoperability with 40 Gigabit Ethernet equipment
- Low latency is ideal for use in high performance computer clustering, financial trading, and other latency sensitive applications
- Low profile latching allows high density belly to belly installation
- Constructed with 8-pair twinaxial cable factory terminated to QSFP+ 40 Gb/s hot pluggable modular connectors
- 100% tested for assured system performance
- Available for 40GBASE-CR4 Ethernet applications for distances up to 7 meters and InfiniBand QDR applications up to 5 meters
- Advanced proprietary connector paddle card design reduces crosstalk



PQSFPXA1MBU

Part Number	Part Description	Length (m)	AWG Size	Cable Color	Std. Pkg. Qty.	Std. Ctn. Qty.
40GBASE-CR4						
PQSFPXA1MBU	40GBASE-CR4 Ethernet high speed twin axial cable assembly with QSFP+ 40 Gb/s hot pluggable modular connectors on each end.	1	30	Blue	1	10
PQSFPXA2MBU		2	30	Blue	1	10
PQSFPXA3MBU		3	30	Blue	1	10
PQSFPXB4MBU		4	28	Blue	1	10
PQSFPXC5MBU		5	26	Blue	1	10
PQSFPXD6MBU		6	24	Blue	1	10
PQSFPXD7MBU		7	24	Blue	1	10
InfiniBand QDR						
PQSFPQA1MBU	InfiniBand QDR high speed twinaxial cable assembly with QSFP+ 40 Gb/s hot pluggable modular connectors on each end.	1	30	Blue	1	10
PQSFPQA2MBU		2	30	Blue	1	10
PQSFPQB3MBU		3	30	Blue	1	10
PQSFPQC4MBU		4	26	Blue	1	10
PQSFPQD5MBU		5	24	Blue	1	10

Labels for Cable

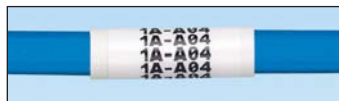

Suggested Label Solutions for TIA/EIA-606-A Compliance				
Cable Part Number	Laser/Ink Jet Desktop Printer Label	TDP43ME Thermal Transfer Desktop Printer Label	PanTher™ LS8E Hand-Held Printer Label	Cougar™ LS9 Hand-Held Printer Label
All cable assemblies on this page	S100X225YAJ	S100X225VATY	S100X225VAC	T100X000CBC-BK

For complete labeling solutions and product information, reference charts on pages O.1 – O.25.

QSFP+ to Four SFP+ Copper Hydra Cable Assemblies

- Compliant to SFF-8431 and 8436, which allows compatibility with 40GBASE-CR4 QSFP+ and 10 GbE SFP+ enabled equipment; hot pluggable to QSFP+/SFP+ compliant host ports
- Ideal for Top of Rack (ToR) applications
- EEPROM compliant to SFF-8472 and 8436, which ensures interoperability with 10 GbE and 40 GbE equipment
- Passive low power provides a low cost alternative to fiber optics up to 3.5 meters
- Low latency performance is ideal for high performance computer clustering, financial trading, and other latency sensitive applications
- Constructed of high speed twinaxial cable factory terminated to QSFP+ and SFP+ modular connectors
- Advanced connector design and continuous shielding throughout the assembly provide excellent resistance to EMI and alien crosstalk
- Tak-Ty® Hook & Loop Cable Ties allow adjustable breakout points on the hydra end of the cable assembly
- QSFP+ connectors triple switch port density, which is ideal for high density deployment
- Robust easy-to-use latching feature allows high density belly-to-belly installation



PHQ4SFPXA1MBL

Part Number	Part Description	Length (m)	AWG Size	Cable Color	Std. Pkg. Qty.	Std. Ctn. Qty.
PHQ4SFPXA1MBL	High speed, 2-pair, twinaxial cable, factory terminated to QSFP+ and four SFP+ modular connectors.	1	30	Black	1	10

*For lengths other than 1 meter (1.5, 2, 2.5, 3, 3.5) change the length designation in the part number to the desired length. For example, the part number for a 2-meter cable assembly is PHQ4SFPXA2MBL.

QuickNet™ Cable Assemblies

- Allow quick network deployment compared to field-terminated installations
- 100% performance tested to electrical permanent link specifications; shipped with permanent link test data for each link
- Terminated in factory controlled environment for consistent network performance
- Pre-bundled with six cables for easy installation
- Plenum or riser cable flame ratings
- Category 6 UTP and Category 6A UTP/Shielded performance levels available
- Available in many common standard lengths and in one foot increments from 10 to 295 feet
- Enable multiple termination types including, pre-terminated cassettes, jack modules, modular plugs, plug pack and/or unterminated options
- Pre-terminated cassettes snap in and out of QuickNet™ Patch Panels
- Quality assurance label includes serialized number for future traceability, performance level, and assembly length

Ready to Order parts in common lengths and configurations

Simple 3 – Step process to obtain ordering information for QuickNet™ Standard Assembly:

1. Choose Performance Level of Cable Assembly
2. Choose Riser or Plenum Cable Type
3. Select desired length of assembly from those listed and replace “nn” with that length

Performance Level and Description	Cable Type	Part Number Template	Available Assembly Lengths (in feet)
Category6A UTP QuickNet™ Cable Assembly made with TX6A™ 10Gig™ UTP Copper Cable with MaTriX Technology and pre-terminated TX6A™ 10Gig™ UTP Jack Module Cassettes on each end.	Riser	QZRBCBCBXX <u>nn</u>	<u>nn</u> = 10, 15, 20, 25, 30, 35, 40, 45, 50, 55, 60, 65, 70, 75 or 80
	Plenum	QZPBCBCBXX <u>nn</u>	
Category6A SDUTP QuickNet™ Cable Assembly made with TX6A-SD™ 10Gig™ UTP Copper Cable with MaTriX Technology and pre-terminated TX6A™ 10Gig™ UTP Jack Module Cassettes on each end.	Riser	QXRBCBCBXX <u>nn</u>	
	Plenum	QXPBCBCBXX <u>nn</u>	
Category6 UTP QuickNet™ Cable Assembly made with Category 6 UTP Cable and pre-terminated TX6™ PLUS UTP Jack Module Cassettes on each end.	Riser	QCRBCBCBXX <u>nn</u>	
	Plenum	QCPBCBCBXX <u>nn</u>	

Termination Options



Pre-Terminated UTP Cassette



Pre-Terminated Shielded Cassette



Jack Modules



Modular Plugs



Plug Pack



Un-Terminated

QuickNet™ Configure to Order Cable Assemblies

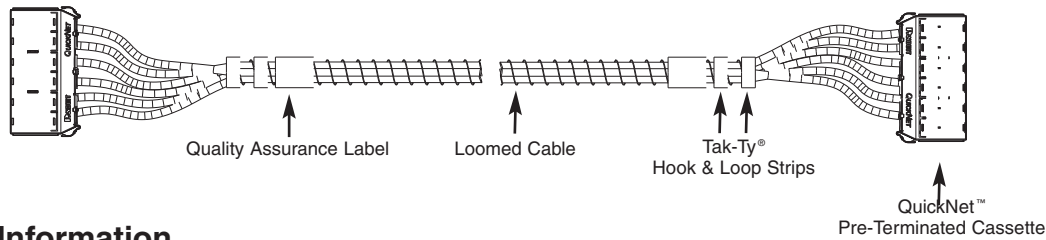

Ordering Information

Part Number
Example:

Q	Z	P	B	C	B	C	B	X	X	10
1	2	3	4	5	6	7	8	9	10	11

Example – The above part number is a 10 foot QuickNet™ Cable Assembly constructed of Category 6A, UTP, plenum cable (blue) with a pre-terminated cassette (blue jacks installed) on each end.

1 – Q = QuickNet™

2 – Performance Level

- B = Category 6 Enhanced UTP
- C = Category 6 UTP
- E = Category 6A (TX6A™ 10Gig™) Shielded
- X = Category 6A (TX6A-SD™ 10Gig™) UTP MaTriX
- Z = Category 6A (TX6A™ 10Gig™) UTP MaTriX

3 – Flame/Smoke Rating

- R = Riser or P = Plenum

4 – Cable Color

- B = Blue or W = White

5 – Termination End 1

- C = Cassette
- J = Jack modules
- P = Modular plugs
- K = Jack modules staggered right
- L = Jack modules staggered left
- Q = Modular plugs staggered right
- S = Modular plugs staggered left

6 – Termination End 1 Color Options

Jack Module Color Options

- B = Blue, E = Electric Ivory, G = Green, H = Off White, I = International Gray, L = Black, O = Orange, R = Red, V = Violet, W = White, Y = Yellow
- Shielded Jack Modules, chose option L (all Shielded Jack Modules are Black)

Modular Plug and Underterminated Color Options

- X = No color option available, all modular plugs are clear

7 – Termination End 2

- C = Cassette
- J = Jack modules
- P = Modular plugs
- A = Plug pack (6-pack)
- R = Recessed plug pack (6-pack)
- K = Jack modules staggered right
- L = Jack modules staggered left
- Q = Modular plugs staggered right
- S = Modular plugs staggered left
- U = Underterminated
- O = Underterminated with cassette and jack modules for on-site termination

8 – Termination End 2 Color Options

Jack Module Color Options

- B = Blue, E = Electric Ivory, G = Green, H = Off White, I = International Gray, L = Black, O = Orange, R = Red, V = Violet, W = White, Y = Yellow
- Shielded Jack Modules, chose option L (all Shielded Jack Modules are Black)

Plug Pack Color Options

- B = Blue, W = White, R = Red, L = Black

Recessed Plug Pack Color Option

- S = Silver

Modular Plug and Underterminated Color Option

- X = No color option available, all modular plugs are clear

9 – Assembly Options

- P = Pulling eye
- X = No assembly options requested

10 – Custom Labeling*

- L = Custom assembly label
- C = Custom cable labels
- B = Custom assembly and cable labels
- X = No custom labels requested

11 – Assembly Length**

- 10' to 295' (one foot increments)

*Custom cable assembly labels are available up to eighteen characters; individual cable labels are available up to fifteen characters.

**For cable assemblies constructed of Category 6A (TX6A-SD™ 10Gig™) UTP MaTriX Copper Cable, the maximum length is 196 ft. (60m). All connectivity is wired T568B. Category 6 Enhanced Performance level utilizes Panduit® TX6500™ Category 6 UTP Cable. Permanent link test results shipped with each cable assembly.

QuickNet™ Plug Pack Cable Assemblies

- Facilitate quick and easy connection and disconnection of multiple patch cords, simultaneously to a variety of switches, reducing time and cost associated when installing and maintaining structured cabling links
- Available in 6, 8, or 12-pack configurations for optimal switch compatibility
- Recessed version available when additional clearance is required at the switchport
- Available in Category 6A and Category 6 Performance levels for UTP installations and Category 6A shielded installations
- Plug meets all applicable FCC part 68 Subpart F requirements and exceeds IEC 60603-7 specifications
- Meet requirements of IEEE 802.3af and IEEE 802.3at for PoE applications
- Each patch cord is 100% performance tested
- Integrated finger latch enables quick, one-handed installation and removal from switch
- Low profile design allows assemblies to be installed side by side or stacked on top of each other providing maximum port density in high density installations
- Marker ties enable easy identification in high density installations and provides additional level of security when used with optional lock in device
- Labels on patch cords provide identification of performance level, length, and quality control number
- Optional removal tool (QPVRT) facilitates removal of individual cable links without disrupting service to other network connections
- Optional lock in device (QPPLD6-X and QPPLD8-X) prevents unintentional removal of assembly from the switch for an additional level of security
- UTP cable available in blue or white; shielded cable available in blue or international gray
- Plug packs available in blue or white; recessed version available in silver

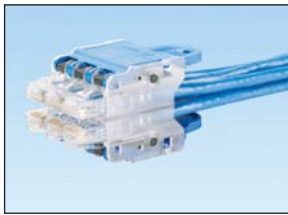

6-Pack Plug Pack



8-Pack Plug Pack



12-Pack Plug Pack



6-Pack Recessed Plug Pack

Part Number	Part Description	Cable Color	Termination End 1	Color	Termination End 2	Length		Std. Pkg. Qty.	Std. Ctn. Qty.
						Ft.	m		
Category 6A UTP									
QPAZCBAB07	QuickNet® Plug Pack Cable Assembly made with Category 6A, CM blue UTP cable with a 6-pack blue plug pack on one end and modular plugs on the other end.	Blue	Modular Plugs	Blue Plug Pack	Plug Pack with Modular Plugs	7	2.13	1	10
Category 6A Shielded									
QPPEDBAB07	QuickNet® Plug Pack Cable Assembly made with Category 6A, dual rated (CM/LSZH) blue shielded cable with a 6-pack blue plug pack on one end and modular plugs on the other end.	Blue	Modular Plugs	Blue Plug Pack	Plug Pack with Modular Plugs	7	2.13	1	10
Category 6 UTP									
QPPCCBAB07	QuickNet® Plug Pack Cable Assembly made with Category 6, CM blue cable with a 6-pack blue plug pack on one end and modular plugs on the other end.	Blue	Modular Plugs	Blue Plug Pack	Plug Pack with Modular Plugs	7	2.13	1	10

Removal tool available on page B.13.

Lock in device available on page B.13.

The above part numbers in the table represent 6 pack QuickNet™ Plug Pack assemblies. To build your own standard part number, see the configurator on the facing page.

QuickNet™ Plug Pack Cable Assembly Ordering Information

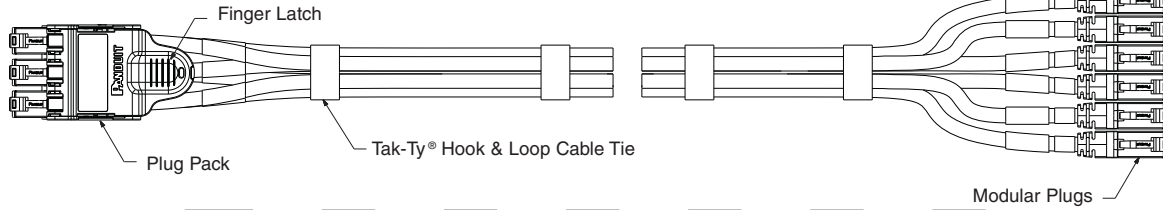

Part Number
Example:

QPP	A	C	B	A	B	03
1	2	3	4	5	6	7

Example – The above part number is a 3 foot QuickNet™ Plug Pack Cable Assembly constructed of Category 6A, UTP, CM cable (blue) with a 6 plug pack (blue) on one end and modular plugs on the other end.

1 – QuickNet™ Plug Pack Assembly (QPP)

2 – Performance Level

- A = Category 6A (TX6A™10Gig™) UTP MaTriX
- X = Category 6A (TX6A-SD™10Gig™) UTP MaTriX
- E = Category 6A (10Gig™)/Category 6 Shielded*
- C = Category 6 UTP

3 – Flame/Smoke Rating

- C = CM (UTP only)
- D = Dual rated CM and LSZH (shielded only)

4 – Cable Color

- B = Blue
- W = White (UTP only)
- G = International Gray (shielded only)

5 – Plug Pack Configuration

- A = 6-pack
- B = 12-pack
- D = 8-pack
- R = Recessed 6-pack

6 – Plug Pack Color

- B = Blue
- W = White
- S = Silver (Recessed version only)

7 – Assembly Length

- 03 = 3 feet
- 05 = 5 feet
- 07 = 7 feet
- 10 = 10 feet
- 14 = 14 feet

All UTP cable is available in CM Flame/Smoke Rating.
*All shielded cable is dual rated for CM and LSZH applications.

Component Labels for QuickNet™ Plug Pack Assemblies



Suggested Label Solutions for TIA/EIA-606-A Compliance

Part Number	Laser/Ink Jet Desktop Printer Label	TDP43ME Thermal Transfer Desktop Printer Label	PanTher™ LS8E Hand-Held Printer Label	Cougar™ LS9 Hand-Held Printer Label
All QuickNet™ Plug Pack Assemblies	C125X030FJJ	C125X030YPT	C125X030FJC	T050X000VPC-BK

For complete labeling solutions and product information, reference charts on pages O.1 – O.25.

QuickNet™ Patch Panels and Accessories

- Accept QuickNet™ Copper Cable Assemblies and QuickNet™ SFQ Series MTP* Fiber Optic Cassettes which snap in and out with one hand
- High-density patch panels conserve valuable rack space
- Angled patch panels facilitate proper bend radius control and minimize the need for horizontal cable managers
- Pre-printed numbers above each port for easy identification
- Mount to standard EIA 19" racks or 23" racks with optional extender brackets
- Zero RU brackets (FQCBRUA) mount up to two QuickNet™ Cassettes directly to rack or enclosure without utilizing additional rack space
- Optional patch panel adapter (QPPABL) accepts all Mini-Com® Modules for UTP, fiber optic, and audio/visual applications
- Optional patch panel blank (QPPBBL) promotes proper airflow and cooling
- Label/label cover kit (QPPLC24) provides port and panel identification for 24-port patch panels
- QuickNet™ All Metal Modular Patch Panels accept shielded cassettes with no grounding kit required
- If not using QuickNet™ All Metal Modular Patch Panels, optional retrofit grounding kit (QNSMRRT) is required to ground shielded cassettes to QuickNet™ Modular Patch Panels



QAPP24BL



QASP24BL



QAPP48HDBL



QASP48HDBL



QPP24BL



QSP24BL



QPP48HDBL



QSP48HDBL



QPPABL



QPPBBL

Part Number	Part Description	No. of Rack Spaces [^]	Std. Pkg. Qty.	Std. Ctn. Qty.
-------------	------------------	---------------------------------	----------------	----------------

QuickNet™ Angled Patch Panels

QAPP24BL	24-port angled patch panel which accepts QuickNet™ Pre-Terminated Cassettes and Patch Panel Adapters.	1	1	10
QASP24BL	24-port, all metal angled patch panel which accepts QuickNet™ Pre-Terminated Shielded Cassettes and Patch Panel Adapters.	1	1	10
QAPP48HDBL	48-port angled patch panel which accepts QuickNet™ Pre-Terminated Cassettes and Patch Panel Adapters.	1	1	10
QAPP48HDVNSBL	48-port angled patch panel which accepts QuickNet™ Pre-Terminated Cassettes and Patch Panel Adapters. Numbering sequence is top to bottom across patch panel.	1	1	10
QASP48HDBL	48-port, all metal angled patch panel which accepts QuickNet™ Pre-Terminated Shielded Cassettes and Patch Panel Adapters.	1	1	10

QuickNet™ Flat Patch Panels

QPP24BL	24-port patch panel which accepts QuickNet™ Pre-Terminated Cassettes and Patch Panel Adapters.	1	1	10
QSP24BL	24-port, all metal patch panel which accepts QuickNet™ Pre-Terminated Shielded Cassettes and Patch Panel Adapters.	1	1	10
QPP48HDBL	48-port patch panel which accepts QuickNet™ Pre-Terminated Cassettes and Patch Panel Adapters.	1	1	10
QPP48HDVNSBL	48-port patch panel which accepts QuickNet™ Pre-Terminated Cassettes and Patch Panel Adapters. Numbering sequence is top to bottom across patch panel.	1	1	10
QSP48HDBL	48-port, all metal patch panel which accepts QuickNet™ Pre-Terminated Shielded Cassettes and Patch Panel Adapters.	1	1	10

Patch Panel Adapter

QPPABL	QuickNet™ Patch Panel Adapter which accepts Mini-Com® Modules for UTP, fiber optic, and audio/visual applications.	—	1	10
---------------	--	---	---	----

Patch Panel Blank

QPPBBL	QuickNet™ Patch Panel Blank reserves space for future use and promotes proper airflow and cooling.	—	1	10
---------------	--	---	---	----

Patch Panel Label Kit

QPPLC24	Label/label cover kit for 24-port QuickNet™ Patch Panels. Each kit contains four labels and four clear label covers per bag.	—	1	10
----------------	--	---	---	----

*MTP is a registered trademark of US Conec Ltd.

[^]One rack space = 1.75" (44.45mm). M6 and #12-24 mounting screws included. QuickNet™ Pre-Terminated Cable Assemblies available on pages B.8 – B.9. QuickNet™ SFQ Series MTP* Fiber Optic Cassettes available on page C.45.

QuickNet™ Plug Pack Housings

- Facilitate quick and easy connection and disconnection of multiple patch cords, simultaneously to a variety of switches, reducing time and cost associated when installing and maintaining structured cabling links
- Available in 6, 8, or 12-pack configurations for optimal switch compatibility
- Recessed version available when additional clearance is required at the switch port
- Integrated finger latch enables quick, one-handed installation and removal from switch
- Low profile design allows assemblies to be installed side by side or stacked on top of each other providing maximum port density in high density installations
- Marker ties enable easy identification in high density installations and provides additional level of security when used with optional lock in device
- Optional removal tool (QPVRT) facilitates removal of individual cable links without disrupting service to other network connections
- Optional lock in device (QPPLD6-X or QPPLD8-X) prevents unintentional removal of assembly from the switch for an additional level of security



QPPN6BU



QPPNR6S

Part Number	Part Description	Std. Pkg. Qty.	Std. Ctn. Qty.
QPPN6BU*	QuickNet™ Plug Pack accepts six Panduit RJ45 modular plugs.	1	10
QPPN8BU*	QuickNet™ Plug Pack accepts eight Panduit RJ45 modular plugs.	1	10
QPPN12BU*	QuickNet™ Plug Pack accepts twelve Panduit RJ45 modular plugs.	1	10
QPPNR6S	QuickNet™ Recessed Plug Pack accepts six Panduit RJ45 modular plugs.	1	10

*For standard colors other than BU (Blue), replace BU in part number with BL (Black), RD (Red), or WH(White). Recessed Plug Pack available in silver only.

QuickNet™ Plug Pack Removal Tool

- Allows individual patch cords to be removed from a plug pack without disruption of other network connections
- Compatible with 6, 8, and 12-pack QuickNet™ Plug Pack Assemblies



Part Number	Part Description	Std. Pkg. Qty.
QPVRT	Removal tool allows individual patch cords to be removed from a plug pack without disruption of other network connections.	1

QuickNet™ Plug Pack Assemblies available on pages B.10 and B.11.

QuickNet™ Plug Pack Lock-in Device

- Prevents unintentional removal of QuickNet™ Plug Pack Assembly from the switch
- Marker tie (included with assembly) can be used to connect plug pack and lock-in device for additional level of security
- Two recommended per plug pack



QPPLD6-X

Part Number	Part Description	Std. Pkg. Qty.	Std. Ctn. Qty.
QPPLD6-X	Lock-in device prevents unauthorized removal of patch cords from 6 and 12-pack plug pack.	10	100
QPPLD8-X	Lock-in device prevents unauthorized removal of patch cords from 8-pack plug pack. Recommended quantity two per 8-pack.	10	100

Recommended quantity two QPPLD6 per 6-pack plug pack, four QPPLD6 per 12-pack plug pack, and two QPPLD8 per 8-pack plug pack.

QuickNet™ Plug Pack Assemblies available on pages B.10 and B.11.

TX6A™ 10Gig™ U/FTP Shielded Copper Cable

- Exceeds requirements of ANSI/TIA-568-C.2 Category 6A, IEEE 802.3an-2006, and ISO 11801 Class E_A channel standards
- Exceeds requirements of ANSI/TIA-568-C.2 Category 6A and IEC 61156-5 Category 6A component standards
- Meets requirements of IEEE 802.3af and IEEE 802.3at for PoE applications
- Cable diameter: Riser 0.308 in. (7.8mm) nominal, Plenum 0.295 in. (7.5mm) nominal
- Installation temperature range: 32°F to 140°F (0°C to 60°C)
- Operating temperature range: 14°F to 140°F (-10°C to 60°C)
- Descending length cable markings enable easy identification of remaining cable which reduces installation time and cable scrap



Part Number	Part Description	Color‡	Std. Pkg. Qty. (Ft.)	Std. Ctn. Qty. (Ft.)
Riser				
PUFR6X04BU-UG	Category 6A, riser (CMR), 4-pair, U/FTP shielded copper cable. Copper conductors are 23 AWG with HDPE insulation. Conductors are twisted in pairs, each individual twisted pair includes a metallic foil shield and is protected by a flame-retardant PVC jacket.	Blue	1000	15000
Plenum				
PUFP6X04BU-UG	Category 6A, plenum (CMP), 4-pair, U/FTP shielded copper cable. Copper conductors are 23 AWG with FEP insulation. Conductors are twisted in pairs, each individual twisted pair includes a metallic foil shield and is protected by a low smoke, flame-retardant PVC jacket.	Blue	1000	15000

‡For standard colors other than Blue, replace BU (Blue) with WH (White), YL (Yellow), or IG (International Gray). Order number of pieces required, in multiples of 5,000 feet.

Must be installed as part of a complete TX6A™ 10Gig™ Copper Cabling System in order to achieve 10GBASE-T certified performance.

In data center and telecommunication room applications, Panduit recommends that both-ends of shielded cable link be bonded if the channel is contained in the same building and any multiple serving AC power systems are inter-system bonded. For workstation applications, it is recommended that the cable link be bonded through the normal process in the telecommunication room and through the patch cord at the workstation, which provides the proper path to ground via the computer's AC power plug.

TX6A™ 10Gig™ Shielded F/UTP Copper Cable

- Exceeds requirements of ANSI/TIA-568-C.2 Category 6A, IEEE 802.3an-2006, and ISO 11801 Class E_A channel standards
- Exceeds requirements of ANSI/TIA-568-C.2 Category 6A and IEC 61156-5 Category 6A component standards
- Meets requirements of IEEE 802.3af and IEEE 802.3at for PoE applications
- Cable diameter 0.284 in. (7.2mm) nominal
- Installation temperature range: -20°F to 75°F (-4°C to 167°C) during installation and operation
- Descending length cable markings enable easy identification of remaining cable which reduces installation time and cable scrap



Part Number	Part Description	Color	Std. Pkg. Qty.	Std. Ctn. Qty.
PFR6X04BU-CG	Category 6A riser (CMR) 4-pair F/UTP shielded copper cable. Conductors are 23 AWG with PE insulation. Conductors are twisted in pairs, separated by an integrated pair separator, all four pairs surrounded by an overall metallic foil shield and protected by a low smoke zero halogen jacket.	Blue	1000	27000

‡For standard colors other than Blue, replace BU (Blue) with WH (White).

Order number of pieces required, in multiples of 9,000 feet.

Must be installed as part of a complete TX6A™ 10Gig™ Copper Cabling System in order to achieve 10GBASE-T certified performance.

In data center and telecommunication room applications, Panduit recommends that both-ends of shielded cable link be bonded if the channel is contained in the same building and any multiple serving AC power systems are inter-system bonded. For workstation applications, it is recommended that the cable link be bonded through the normal process in the telecommunication room and through the patch cord at the workstation, which provides the proper path to ground via the computer's AC power plug.

TX7000™ Shielded S/FTP Marine Copper Cable

- Exceeds requirements of ISO 11801 Class E_A and ANSI/TIA-568-C.2 Category 6A channel standards
- Meets or exceeds the requirements of IEC 61156-5 Category 7 component standards at swept frequencies up to 600 MHz
- Meets requirements of IEEE 802.3af and IEEE 802.3at for PoE applications
- Robust cable jacket oil and fuel resistant for harsh environments
- Flame rated to meet IEC 60754-1, IEC 60754-2, IEC 61034-2, IEC 60332-3-24
- Chemical resistance tested to mineral oil IRM 902 (IEC 60811-2-1) and diesel fuel IRM 903 (IEC 60811-2-1)
- Third party tested to exceed the application requirements of Det Norske Veritas, American Bureau of Shipping, and ETL
- DNV certification number E-10447
- ABS certification number 10-HS638424-1-PDA
- Ideal for harsh environments encountered in marine applications, including ship and offshore/onshore units
- Cable diameter 8.2 mm (0.322 in) nominal
- Installation temperature range: -15°C to 50°C (5°F to 122°F)
- Operating temperature range: -40°C to 85°C (-40°F to 185°F)
- Descending cable length markings enable easy identification of remaining cable which reduces installation time and cable scrap
- Packaged on a reel



PSM7004BU

Part Number	Part Description	Color	Std. Pkg. Qty. (Ft.)	Std. Ctn. Qty. (Ft.)
PSM7004BU-KD	Category 7 low smoke, halogen free, fire retardant (LSHF-FR), 4-pair S/FTP shielded marine copper cable. Stranded copper conductors are 4 x 2/0.27mm ² . Conductors are twisted in pairs, each individual twisted pair is surrounded by a foil, covered with an overall braided shield and is protected by an oil and fuel resistant, low smoke, halogen free, and fire retardant jacket.	Blue	1640	19680
PSM7004BU-KM	Category 7 low smoke, halogen free, fire retardant (LSHF-FR), 4-pair S/FTP shielded marine copper cable. Stranded copper conductors are 4 x 2/0.27mm ² . Conductors are twisted in pairs, each individual twisted pair is surrounded by a foil, covered with an overall braided shield and is protected by an oil and fuel resistant, low smoke, halogen free, and fire retardant jacket.	Blue	3280	13120

Order number of pieces required, in multiples of 13,120 feet.
Must be installed as part of a complete TX6A™ 10Gig™ Copper Cabling System in order to achieve 10GBASE-T certified performance.

Labels for Cable

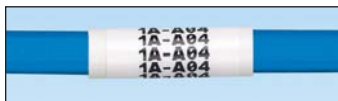

Suggested Label Solutions for TIA/EIA-606-A Compliance				
Cable Part Number	Laser/Ink Jet Desktop Printer Label	TDP43ME Thermal Transfer Desktop Printer Label	PanTher™ LS8E Hand-Held Printer Label	Cougar™ LS9 Hand-Held Printer Label
All cable on pages B.10, B.11 and B.19	S100X225YAJ	S100X225VATY	S100X225VAC	T100X000CBC-BK

For complete labeling solutions and product information, reference charts on pages O.1 – O.25.

UL **US** **Mini-Com**[®] **TX6A**[™] **10Gig**[™] **Shielded Jack Modules**

- Exceed requirements of ANSI/TIA-568-C.2 Category 6A, IEEE 802.3an-2006, and ISO 11801 Class E_A channel standards
- Exceed requirements of ANSI/TIA-568-C.2 Category 6A and IEC 61156-5 Category 6_A component standards
- Meet requirements of IEEE 802.3af and IEEE 802.3at for PoE applications
- Color-coded, keyed jack modules mechanically and visually distinguish connections to prevent unintentional mating with unlike keyed or non-keyed modular plugs accommodating more discrete networks
- Each jack is 100% tested to ensure NEXT and RL performance and is individually serialized for traceability
- Utilize patent-pending enhanced Giga-TX[™] Technology for jack terminations which optimizes performance by maintaining cable pair geometry and eliminating conductor untwist
- Fully grounded and bonded to patch panel when installed in Panduit All Metal Modular Patch Panel
- Contacts plated with 50 microinches of gold for superior performance
- No punchdown tool required; termination tool (EGJT) ensures conductors are fully terminated by utilizing a smooth forward motion without impact on critical internal components for maximum reliability
- Optional termination tool (TGJT) reduces termination time by 25%, ideal for high volume installations
- Can be re-terminated a minimum of twenty times
- Blue termination cap designates 10Gig[™] Category 6A performance and provides positive strain relief; helps control cable bend radius and securely retains wires
- Terminate 4-pair, 22 – 26 AWG, 100 ohm, solid or stranded shielded twisted pair cable
- Universal termination cap is color-coded for T568A and T568B wiring schemes
- Integrated strain relief with wire cap provides 360° conductive path for grounding
- 0.187 in. grounding tab provides conductive patch for grounding individual jacks
- Accept 6 and 8-position modular plugs without damage
- Can be clearly identified with optional labels and icons
- Compatible with Mini-Com[®] Modular Patch Panels, Faceplates, and Surface Mount Boxes
- Optional RJ45 blockout device blocks out unauthorized access to jack modules and potentially harmful foreign objects, saving time and money associated with data security breaches, network downtime, repair, and hardware replacement
- Optional dust cap keeps out dust and debris while not in use



CJS6X88TGY



CJSK6X88TGBL

Part Number	Part Description	No. of Module Spaces	Color	Std. Pkg. Qty.	Std. Ctn. Qty.
Jack Module					
CJS6X88TGY	Category 6A, RJ45, 10 Gb/s, 8-position, 8-wire universal shielded black module with integral shield.	1	Black	1	50
Keyed Jack Module					
CJSK6X88TGBL*	Keyed, Category 6A, RJ45, 10 Gb/s, 8-position, 8-wire universal shielded module with integral shield.	1	Black	1	50

*For standard colors other than Black, replace suffix BL (Black) with BU (Blue), RD (Red), YL (Yellow), GR (Green), OR (Orange), VL (Violet), or GY (Gray). Each color representing a different keyed configuration. Termination tools available on page B.97.

Shield grounding requires proper installation of shielded jack module and the use of shielded patch cords and cable.

For grounding shielded modules not installed in a shielded patch panel, see the shielded jack module grounding kit, CJSJK-XY on page M.23.

All Metal Modular Patch Panels available on page B.73.

RJ45 blockout device available on page B.92.

Dust cap available on page B.97.

Contact customer service for bulk packaged jack modules.

Must be installed as part of a complete TX6A[™] 10Gig[™] Copper Cabling System in order to achieve 10GBASE-T certified performance.

cUL^{us} Mini-Com® TX6A™ 10Gig™ Shielded Jack Modules (continued)

Keyed Geometry



Black Key



Red Key



Green Key



Yellow Key



Orange Key



Blue Key



Violet Key



Intl. Gray Key



Black Key



Red Key



Green Key



Yellow Key



Orange Key



Blue Key



Violet Key



Intl. Gray Key

Component Labels for Mini-Com® TX6A™ 10Gig™ Shielded Jack Modules



Suggested Label Solutions for TIA/EIA-606-A Compliance

Module Part Number	Laser/Ink Jet Desktop Printer Label	TDP43ME Thermal Transfer Desktop Printer Label	PanTher™ LS8E Hand-Held Printer Label	Cougar™ LS9 Hand-Held Printer Label
CJS6X88TGY CJSK6X88TGBL	C138X019FJJ	C138X019YPT	C138X019FJC	T019X000FJC-BK

For complete labeling solutions and product information, reference charts on pages O.1 – O.25.

UL US TX6A™ 10Gig™ Shielded Patch Cords

- Exceed requirements of ANSI/TIA-568-C.2 Category 6A, IEEE 802.3an-2006, and ISO 11801 Class E_A channel standards
- Exceed requirements of ANSI/TIA-568-C.2 Category 6A and ISO 11801 Class E_A component standards
- Meet requirements of IEEE 802.3af and IEEE 802.3at for PoE applications
- Color-coded, keyed modular plugs mechanically and visually distinguish connections to prevent unintentional mating with unlike keyed or non-keyed jack modules accommodating more discrete networks
- Each patch cord is 100% performance tested to component limits and wired T568B
- Constructed of 26 AWG stranded shielded copper cable (nominal cable diameter is 0.23 in.) and TX6™ PLUS Shielded Modular Plugs for superior performance
- Cable includes overall metal shield that provides conductive path for grounding
- Plug meets all applicable ANSI/TIA-968-A requirements and exceeds IEC 60603-7 specifications
- Plug uses an integral pair manager to optimize performance and consistency by reducing untwisting of conductors within the plug
- Plug performance in center of TIA/EIA component range, ensuring interoperability and 10GBASE-T Ethernet channel performance
- Labels on patch cords provide identification of performance level, length, and quality control number
- Patented tangle-free latch prevents snags and provides easy release, saving time on frequent moves, adds, and changes
- Optional patch cord color bands snap on and off individual patch cables offering endless color-coding options
- Optional RJ45 plug lock-in device blocks unauthorized removal of cable, IP phone, other networking equipment, or critical connection

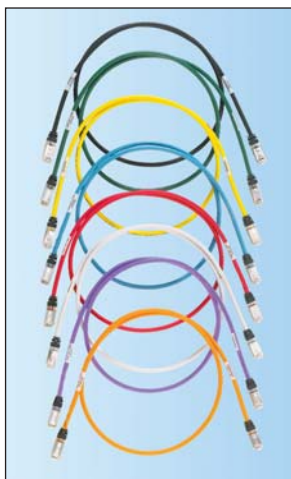

Part Number	Part Description	Length (Ft.)	Cable Color	Std. Pkg. Qty.	Std. Ctn. Qty.
Patch Cord					
STP6X3IG‡	Category 6A, 10 Gb/s S/FTP patch cord with TX6™ PLUS Modular Plugs on each end.	3	Off White	1	10
Keyed Patch Cord					
STPK6X3BL*	Keyed, Category 6A, shielded patch cord with TX6™ PLUS Keyed Modular Plug on one end and TX6™ Non-Keyed Modular Plug on the other end.	3	Black	1	10

‡For lengths 2 to 20 feet (increments of one foot) and 25, 30, 35, 40 feet change the length designation in the part number to the desired length. For standard cable colors other than IG (International Gray) replace IG suffix with BL (Black), BU (Blue), GR (Green), RD (Red), YL (Yellow), OR (Orange), or VL (Violet) to end of part number. For example, the part number for a blue 15-foot patch cord is STP6X15BU.
 *For lengths other than 3 feet (5, 7, 10, 14 feet) change the length designation in the part number to the desired length. For standard cable colors other than Black, replace suffix BL (Black) with BU (Blue), RD (red), YL (Yellow), GR (Green) or OR (Orange), each color representing a different keyed configuration.
 Contact customer service for universal reference patch cords.
 Patch cord color bands available on page B.96.
 RJ45 plug lock-in device available on page B.94.
 Must be installed as part of a complete TX6A™ 10Gig™ Copper Cabling System in order to achieve 10GBASE-T certified performance.

Labels for TX6A™ 10Gig™ Shielded Patch Cords



Suggested Label Solutions for TIA/EIA-606-A Compliance				
Patch Cord Part Number	Laser/Ink Jet Desktop Printer Label	TDP43ME Thermal Transfer Desktop Printer Label	PanTher™ LS8E Hand-Held Printer Label	Cougar™ LS9 Hand-Held Printer Label
All Patch Cords	S100X150YAJ	S100X150VATY	S100X150VAC	T100X000CBC-BK

For complete labeling solutions and product information, reference charts on pages O.1 – O.25.



PATENTED

TX6A™ 10Gig™ and TX6A-SD™ 10Gig™ UTP Copper Cable with MaTriX Technology

- Exceeds requirements of ANSI/TIA-568-C.2 Category 6A, IEEE 802.3an-2006, and ISO 11801 Class E_A channel
- Exceeds requirements of ANSI/TIA-568-C.2 Category 6A and IEC 61156-5 Category 6_A component standards
- Superior headroom warranty provides the highest margins above the industry standard for both electrical and alien crosstalk performance
- Meets requirements of IEEE 802.3af and IEEE 802.3at for PoE applications
- Patented cable with MaTriX Technology suppresses alien crosstalk with enhanced internal electrical performance
- Round cable design with reduced cable diameter enables improved cable bundling and optimizes fill capacity
- TX6A™ 10Gig™ UTP Copper Cable available for distances up to 100 meters; cable diameter 0.295 in. (7.5mm) nominal
- TX6A-SD™ 10Gig™ UTP Copper Cable available for distances up to 70 meters, offering smaller cable diameter comparable to Category 6 cable; cable diameter 0.240 in. (6.1mm) nominal
- Installation temperature range: 32°F to 140°F (0°C to 60°C)
- Operating temperature range: -4°F to 167°F (-20°C to 75°C)
- Descending length cable markings enable easy identification of remaining cable which reduces installation time and cable scrap



PUP6A04BU-UG



PUP6ASD04BU-UG

Part Number	Part Description	Color	Std. Pkg. Qty. (Ft.)	Std. Ctn. Qty. (Ft.)
TX6A™ 10Gig™ UTP Copper Cable (100 meter solution)				
PUP6A04BU-UG [‡]	Category 6A, plenum (CMP), 4-pair, UTP copper cable. Copper conductors are 23 AWG with FEP insulation. Conductors are twisted in pairs, separated by an integrated pair divider, surrounded by a patent-pending MaTriX tape and protected by a low-smoke flame-retardant PVC jacket.	Blue	1000	18000
PUR6A04BU-UG ^{‡1}	Category 6A, riser (CMR), 4-pair, UTP copper cable. Copper conductors are 23 AWG with flame-retardant PE insulation. Conductors are twisted in pairs, separated by an integrated pair divider, surrounded by a patent-pending MaTriX tape and protected by a flame-retardant PVC jacket.	Blue	1000	18000
TX6A-SD™ 10Gig™ UTP Copper Cable (70 meter solution)				
PUP6ASD04BU-UG [‡]	Category 6A, riser (CMR), 4-pair, UTP copper cable. Copper conductors are 26 AWG with flame-retardant PVC insulation. Conductors are twisted in pairs, separated by an integrated pair divider, surrounded by a patent-pending MaTriX tape and protected by a flame-retardant PVC jacket. Ideal for installations up to 70 meters. Smallest diameter Category 6A UTP cable on the market at 0.240 in. (6.1mm).	Blue	1000	18000
PUR6ASD04BU-CG [‡]	Category 6A, riser (CMR), 4-pair, UTP copper cable. Copper conductors are 26 AWG with flame-retardant PVC insulation. Conductors are twisted in pairs, separated by an integrated pair divider, surrounded by a patent-pending MaTriX tape and protected by a flame-retardant PVC jacket. Ideal for installations up to 70 meters.	Blue	1000	18000

[‡]For standard colors other than Blue, replace BU (Blue) with WH (White), YL (Yellow), or IG (International Gray).

¹ Substitute PUR6A04BU-CG[‡] for alternative manufacturing location.

Order number of pieces required, in multiples of 9,000 feet.

Must be installed as part of a complete TX6A™ 10Gig™ Copper Cabling System in order to achieve 10GBASE-T certified performance.

Reference page B.15 for appropriate labeling solution.

UL[®] US[®] Mini-Com[®] TX6A™ 10Gig™ UTP Jack Module

- Exceed requirements of ANSI/TIA-568-C.2 Category 6A, IEEE 802.3an-2006, and ISO 11801 Class E_A channel standards
- Exceed ANSI/TIA-568-C.2 Category 6A and IEC 61156-5 Category 6A component standards
- Meet requirements of IEEE 802.3af and IEEE 802.3at for PoE applications
- MaTriX split foil technology provides superior suppression of alien crosstalk (PSANEXT and PSAACRF)
- Superior headroom warranty provides the highest margins above the industry standard for both electrical and alien crosstalk performance
- Color-coded, keyed jack modules mechanically and visually distinguish connections to prevent unintentional mating with unlike keyed or non-keyed modular plugs accommodating more discrete networks
- Each jack is 100% tested to ensure NEXT and RL performance and is individually serialized for traceability
- Utilize patent-pending enhanced Giga-TX™ Technology for jack terminations which optimizes performance by maintaining cable pair geometry and eliminating conductor untwist
- Contacts plated with 50 microinches of gold for superior performance
- No punchdown tool required; termination tool (EGJT) ensures conductors are fully terminated by utilizing a smooth forward motion without impact on critical internal components for maximum reliability
- Optional termination tool (TGJT) reduces termination time by 25%, ideal for high volume installations
- Can be re-terminated a minimum of twenty times
- Blue termination cap designates Category 6A performance and provides positive strain relief; helps control cable bend radius and securely retains wires
- Terminate 4-pair, 22 – 26 AWG, 100 ohm, solid or stranded twisted pair cable
- Universal termination cap is color-coded for T568A and T568B wiring schemes
- Accept 6 and 8-position modular plugs without damage
- Can be clearly identified with optional labels and icons
- Compatible with Mini-Com[®] Modular Patch Panels, Faceplates, and Surface Mount Boxes
- Optional RJ45 blockout device blocks out unauthorized access to jack modules and potentially harmful foreign objects, saving time and money associated with data security breaches, network downtime, repair, and hardware replacement
- Optional dust cap keeps out dust and debris while not in use



CJ6X88TGIW



CJK6X88TGBL

Part Number	Part Description	No. of Module Spaces	Color‡	Std. Pkg. Qty.	Std. Ctn. Qty.
Jack Module					
CJ6X88TGIW‡	Category 6A, RJ45, 10 Gb/s, 8-position, 8-wire universal module. Includes patent pending MaTriX split foil tape.	1	Off White	1	50
Keyed Jack Module					
CJK6X88TGBL*	Keyed, Category 6A, RJ45, 10 Gb/s, 8-position, 8-wire universal module. Includes patent pending MaTriX split foil tape.	1	Black	1	50

‡For standard colors other than Off White, replace suffix IW (Off White) with EI (Electric Ivory), WH (White), AW (Arctic White), IG (International Gray), BL (Black), OR (Orange), RD (Red), BU (Blue), GR (Green), YL (Yellow) or VL (Violet).

*For standard colors other than Black, replace suffix BL (Black) with BU (Blue), RD (Red), YL (Yellow), GR (Green), or OR (Orange), each color representing a different keyed configuration.

Termination tools available on page B.97.

RJ45 blockout device available on page B.92.

Dust cap available on page B.97.

Contact customer service for bulk packaged jack modules.

Must be installed as part of a complete TX6A™ 10Gig™ UTP Copper Cabling System in order to achieve 10GBASE-T certified performance.

cUL us Mini-Com® TX6A™ 10Gig™ UTP Jack Modules (continued)

Keyed Geometry



Black
Key



Red
Key



Green
Key



Yellow
Key



Orange
Key



Blue
Key



Black
Key



Red
Key



Green
Key



Yellow
Key



Orange
Key



Blue
Key

Component Labels for Mini-Com® TX6A™ 10Gig™ UTP Jack Modules



Suggested Label Solutions for TIA/EIA-606-A Compliance

Module Part Number	Laser/Ink Jet Desktop Printer Label	TDP43ME Thermal Transfer Desktop Printer Label	PanTher™ LS8E Hand-Held Printer Label	Cougar™ LS9 Hand-Held Printer Label
All TX6A™ 10Gig™ Jack Modules	C138X019FJJ	C138X019YPT	C138X019FJC	T019X000FJC-BK

For complete labeling solutions and product information, reference charts on pages O.1 – O.25.



DP6A™ 10Gig™ UTP Patch Panels

- Exceed requirements of ANSI/TIA-568-C.2 Category 6A, IEEE 802.3an-2006, and ISO 11801 Class E_A channel standards
- Exceed requirements of ANSI/TIA-568-C.2 Category 6A and IEC 61156-5 Category 6_A component standards
- Meet requirements of IEEE 802.3af and IEEE 802.3at for PoE applications
- Each port is 100% tested to ensure NEXT and RL performance and is individually serialized to support traceability
- Utilize 110 punchdown termination on back panel and include retention cap for each port
- Each port contains a universal label that is color-coded for T568A and T568B wiring schemes
- Contacts plated with 50 microinches of gold for superior performance
- Angled versions allow for higher density applications by easily routing the patch cords to each side of the panel eliminating the need for horizontal cable management
- Terminate 4-pair, 22 – 26 AWG, 100 ohm, solid or stranded twisted pair cable
- Mount to standard EIA 19" rack or 23" racks with optional extender bracket
- Write-on areas for port and panel identification
- Can be clearly identified with labels and icons
- Optional label kits (DPLK24 and DPLK48) contain adhesive label holder and labels for easy port and panel identification



DP246X88TGY

PATENTED



DP486X88TGY



DP246X88TGY



DP486X88TGY

Part Number	Part Description	No. of Rack Spaces [^]	Std. Pkg. Qty.	Std. Ctn. Qty.
DP6A™ 10Gig™ Angled Patch Panels				
DP246X88TGY	24-port, angled, Category 6A, 10 Gb/s patch panel with 24 RJ45 8-position, 8-wire ports.	1	1	10
DP486X88TGY	48-port, angled, Category 6A, 10 Gb/s patch panel with 48 RJ45 8-position, 8-wire ports.	2	1	10
DP6A™ 10Gig™ Flat Patch Panels				
DP246X88TGY	24-port, Category 6A, 10 Gb/s patch panel with 24 RJ45 8-position, 8-wire ports.	1	1	10
DP486X88TGY	48-port, Category 6A, 10 Gb/s patch panel with 48 RJ45 8-position, 8-wire ports.	2	1	10

[^]One rack space = 1.75" (44.45mm).
M6 and #12-24 mounting screws included.
Replaceable punchdown modules available, part number DRJ6X88TGBL.
Termination tool (PDT110) available on page B.91.
Must be installed as part of a complete TX6A™ 10Gig™ Copper Cabling System in order to achieve 10GBASE-T certified performance.

Component Labels for DP6A™ 10Gig® UTP Patch Panels



Suggested Label Solutions for TIA/EIA-606-A Compliance				
Patch Panel Part Number	Laser/Ink Jet Desktop Printer Label	TDP43ME Thermal Transfer Desktop Printer Label	PanTher™ LS8E Hand-Held Printer Label	Cougar™ LS9 Hand-Held Printer Label
All Patch Panels on this Page	C379X030FJJ	C379X030YPT	C379X030FJC	T031X000FJC-BK

For complete labeling solutions and product information, reference charts on pages O.1 – O.25.

Mini-Com® Category 6A UTP Coupler Module



- Designed to exceed performance requirements of the ANSI/TIA-568-C.2 Category 6A and ISO 11801 2nd Edition Class E_A channel standards
- Meet requirements of IEEE 802.3af and IEEE 802.3at for PoE applications
- RJ45 8-position, 8-wire female to RJ45 8-position, 8-wire female pass-through module provides fast and easy plug and play connection of 6 and 8-position RJ45 patch cords
- No tools required
- 100% tested to ensure NEXT and RL performance and is individually serialized for traceability
- Contacts plated with 50 microinches of gold for superior performance
- Can be clearly identified with optional labels and icons
- Compatible with Mini-Com® Modular Patch Panels and Faceplates; not suitable for surface mount box applications
- Optional RJ45 blockout device blocks out unauthorized access to jack modules and potentially harmful foreign objects, saving time and money associated with data security breaches, network downtime, repair, and hardware replacement
- Optional dust cap keeps out dust and debris while not in use



Part Number	Part Description	No. of Module Spaces	Color	Std. Pkg. Qty.	Std. Ctn. Qty.
CC6X88IW	Category 6A, RJ45, 8-position, 8-wire universal coupler module.	1	Off White	1	50

‡For other colors replace suffix IW (Off White) with BL (Black).
 Acts as one connecting hardware component in channel.
 RJ45 blockout device available on page B.92.
 Dust cap available on page B.97.
 TX6A™ 10Gig™ UTP Patch Cords available on page B.25.

Component Labels for Mini-Com® Category 6A UTP Coupler Module



Suggested Label Solutions for TIA/EIA-606-A Compliance				
Module Part Number	Laser/Ink Jet Desktop Printer Label	TDP43ME Thermal Transfer Desktop Printer Label	PanTher™ LS8E Hand-Held Printer Label	Cougar™ LS9 Hand-Held Printer Label
CC6X88IW	C138X019FJJ	C138X019YPT	C138X019FJC	T019X000FJC-BK

For complete labeling solutions and product information, reference charts on pages O.1 – O.25.



Category 6A Coupler Patch Panel

- Coupler panel ports provide fast and easy plug and play connection of 6 and 8-position RJ45 patch cords
- No tools required
- Designed to exceed performance requirements of the ANSI/TIA-568-C.2 Category 6A and ISO 11801 2nd Edition Class E_A channel standards
- Contacts plated with 50 microinches of gold for superior performance
- Can be clearly identified with optional labels and icons
- Mounts to standard EIA 19" rack or 23" racks with optional extender bracket

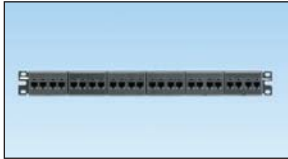

Part Number	Part Description	No. of Rack Spaces [^]	Std. Pkg. Qty.	Std. Ctn. Qty.
CP246X88BL	24-port, Category 6A, patch panel with 24 pre-installed RJ45 Category 6A channel compliant couplers.	1	1	10

[^]One rack space = 1.75" (44.45mm).

M6 and #12-24 mounting screws included.

Each coupler module acts as one connecting hardware component in a channel.

TX6A™ 10Gig™ UTP Patch Cords available on page B.25.

Component Labels for Category 6A Patch Panel

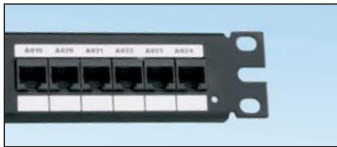

Suggested Label Solutions for TIA/EIA-606-A Compliance				
Module Part Number	Laser/Ink Jet Desktop Printer Label	TDP43ME Thermal Transfer Desktop Printer Label	PanTher™ LS8E Hand-Held Printer Label	Cougar™ LS9 Hand-Held Printer Label
CP246X88BL	C252X030FJJ	C252X030YPT	C252X030FJC	T031X000FJC-BK

cUL^{us} TX6A™ 10Gig™ UTP Patch Cords with MaTriX Technology

- Exceed requirements of ANSI/TIA-568-C.2 Category 6A, IEEE 802.3an-2006, and ISO 11801 Class E_A channel standards
- Meet requirements of IEEE 802.3af and IEEE 802.3at for PoE applications
- MaTriX Technology provides superior suppression of alien crosstalk (PSANEXT and PSAACRF)
- Superior headroom warranty provides the highest margins above the industry standard for both electrical and alien crosstalk performance
- Color-coded, keyed modular plugs mechanically and visually distinguish connections to prevent unintentional mating with unlike keyed or non-keyed jack modules accommodating more discrete networks
- Each patch cord is 100% performance tested to component limits and wired to T568B
- TX6A-SD™ 10Gig™ constructed of 26 AWG stranded copper cable (nominal cable diameter 0.240 in.) and TX6A™ 10Gig™ Modular Plugs for superior performance
- TX6A™ 10Gig™ constructed of 24 AWG stranded copper cable (nominal cable diameter 0.275 in.) and TX6A™ 10Gig™ Modular Plugs for superior performance
- Compatible as a component of any Panduit TX6A™ 10Gig™ UTP Copper Cabling System for increased design flexibility in channels up to 100 meters
- Plug meets all applicable ANSI/TIA-968-A requirements and exceeds IEC 60603-7 specifications
- Slender strain relief boot provides easy access in high density applications
- Plug uses an integral pair manager to optimize performance and consistency by reducing untwisting of conductors within the plug
- Plug performance in center of TIA/EIA component range, ensuring interoperability and 10GBASE-T Ethernet channel performance
- Labels on patch cords provide identification of performance level, length, and quality control number
- Patented tangle-free latch prevents snags and provides easy release, saving time on frequent moves, adds, and changes
- Optional patch cord color bands snap on and off individual patch cables offering endless color-coding options
- Optional RJ45 lock-in device blocks unauthorized removal of cable, IP phone, other networking equipment, or critical connection



Part Number	Part Description	Length (Ft.)	Cable Color	Std. Pkg. Qty.	Std. Ctn. Qty.
TX6A-SD™ 10Gig™ UTP Patch Cord					
UTP6ASD3‡	Category 6A (SD), 26 AWG, 10 Gb/s UTP patch cord with TX6A™ 10Gig™ Modular Plugs on each end. Includes patent pending MaTriX Tape Technology.	3	Blue	1	10
TX6A™ 10Gig™ UTP Patch Cord					
UTP6A3^	Category 6A, 24 AWG, 10 Gb/s UTP patch cord with TX6A™ 10Gig™ Modular Plugs on each end. Includes patent pending MaTriX Tape Technology.	3	Blue	1	50
Keyed TX6A™ 10Gig™ UTP Patch Cord					
UTPK6A3BL*	Keyed, Category 6A, 24 AWG, 10 Gb/s UTP patch cord with TX6A™ 10Gig™ Keyed Modular Plug on one end and TX6A™ 10Gig™ Non-Keyed Modular Plug on the other end. Includes patent pending MaTriX Tape Technology.	3	Black	1	10

‡For lengths 3 to 20 feet (increments of one foot) and 25, 30, 35, 40 feet, change the length designation in the part number to the desired length. For standard cable colors other than Off White, add suffix BL (Black), BU (Blue), RD (Red), YL (Yellow), GR (Green), YL (Yellow), OR (Orange) or VL (Violet) to the part number. For example, the part number for a blue, 15-foot patch cord is UTP6ASD15BU.

^ For lengths 3 to 20 feet (increments of one foot) and 25, 30, 35, 40 feet, change the length designation in the part number to the desired length. For standard cable colors other than Off White, add suffix BL (Black), BU (Blue), RD (Red), YL (Yellow), GR (Green), YL (Yellow), OR (Orange), VL (Violet), or GY (Gray) to the part number. For example, the part number for a blue, 15-foot patch cord is UTP6A15BU.

*For lengths other than 3 feet (5, 7, 10, 14 feet), change the length designation in the part number to the desired length. For standard cable colors other than BL (Black), replace suffix BL (Black) with BU (Blue), RD (Red), YL (Yellow), GR (Green), or OR (Orange), each color representing a different keyed configuration. Contact customer service for universal reference patch cords

Patch cord color bands available on page B.96.

RJ45 plug lock-in device available on page B.94.

Must be installed as part of a complete TX6A™ 10Gig™ Copper Cabling System in order to achieve 10GBASE-T certified performance.

Reference page B.34 for appropriate labeling solution.

UL LISTED **TX6500™ Enhanced Category 6 UTP Copper Cable**

- Exceeds requirements of ANSI/TIA-568-C.2 Category 6 and ISO 11801 2nd Edition Class E channel standards
- Exceeds requirements of ANSI/TIA-568-C.2 and IEC 61156-5 Category 6 component standards
- Meets requirements of IEEE 802.3af and IEEE 802.3at for PoE applications
- Reduced attenuation maximizes the amount of signal that reaches the receiver, increasing bandwidth
- Third party tested to comply with ANSI/TIA-568-C.2
- Cable diameter: Riser 0.265 in. (6.8mm) nominal, Plenum 0.264 in. (6.7mm) nominal
- Installation temperature range: 32°F to 122°F (0°C to 50°C)
- Operating temperature range: 14°F to 140°F (-10°C to 60°C)
- Characterized to 600 MHz, 350 MHz above the standard
- Descending length cable markings enable easy identification of remaining cable which reduces installation time and cable scrap
- Cable supplied in an easy payout EZBrake™ reel-in-a-box

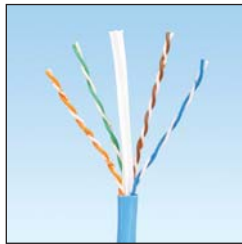

Part Number	Part Description	Color‡	Std. Pkg. Qty. (Ft.)	Std. Ctn. Qty. (Ft.)
Riser				
PUR6504BU-UY	Enhanced, high-performance, Category 6, riser (CMR), 4-pair, UTP copper cable. Copper conductors are 23 AWG construction with polyolefin (PE) insulation. Conductors are twisted in pairs, separated by an integrated pair divider and protected by a flame-retardant PVC jacket.	Blue	1000	27000
Plenum				
PUP6504BU-UY	Enhanced, high-performance, Category 6, plenum (CMP), 4-pair, UTP copper cable. Copper conductors are 23 AWG construction with FEP insulation. Conductors are twisted in pairs, separated by an integrated pair divider and protected by a low smoke, flame-retardant PVC jacket.	Blue	1000	27000

‡For standard colors other than Blue, replace suffix BU (Blue) with WH (White), YL (Yellow), or IG (International Gray). Contact Customer Service for other color options.
Order number of pieces required, in multiples of 9,000 feet.

Labels for TX6500™ Enhanced Category 6 UTP Copper Cable

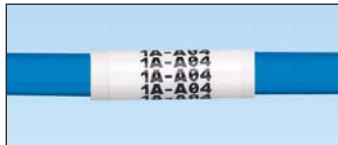

Suggested Label Solutions for TIA/EIA-606-A Compliance				
Cable Part Number	Laser/Ink Jet Desktop Printer Label	TDP43ME Thermal Transfer Desktop Printer Label	PanTher™ LS8E Hand-Held Printer Label	Cougar™ LS9 Hand-Held Printer Label
PUR6504** -UY	S100X150YAJ	S100X150VATY	S100X150VAC	T100X000CBC-BK
PUP6504** -UY				

For complete labeling solutions and product information, reference charts on pages O.1 – O.25.



TX6000™ High Performance Category 6 UTP Copper Cable

- Exceeds requirements of ANSI/TIA-568-C.2 Category 6 and ISO 11801 2nd Edition Class E channel standards
- Exceeds requirements of ANSI/TIA-568-C.2 and IEC 61156-5 Category 6 component standards
- Meets requirements of IEEE 802.3af and IEEE 802.3at for PoE applications
- Third party tested to comply with ANSI/TIA-568-C.2
- Cable diameter: Riser 0.240 in. (6.1mm) nominal, Plenum 0.236 in. (5.9mm) nominal
- Installation temperature range: 32°F to 122°F (0°C to 50°C)
- Operating temperature range: 14°F to 140°F (-10°C to 60°C)
- Characterized to 550 MHz, 300 MHz above the standard
- Descending length cable markings enable easy identification of remaining cable which reduces installation time and cable scrap
- Cable supplied in an easy payout EZBrake™ reel-in-a-box



Part Number	Part Description	Color‡	Std. Pkg. Qty. (Ft.)	Std. Ctn. Qty. (Ft.)
Riser				
PUR6004BU-UY	High performance, Category 6, riser (CMR), 4-pair, UTP copper cable. Copper conductors are 23 AWG construction with polyolefin (PE) insulation. Conductors are twisted in pairs, separated by an integrated pair divider, and protected by a flame-retardant PVC jacket.	Blue	1000	27000
Plenum				
PUP6004BU-UY	High performance, Category 6, plenum (CMP), 4-pair, UTP copper cable. Copper conductors are 23 AWG construction with FEP insulation. Conductors are twisted in pairs, separated by an integrated pair divider, and protected by a low smoke, flame-retardant PVC jacket.	Blue	1000	27000

‡For standard colors other than Blue, replace suffix BU (Blue) with WH (White), YL (Yellow), or IG (International Gray). Contact Customer Service for other color options.
Order number of pieces required, in multiples of 9,000 feet.

Labels for TX6000™ High Performance Category 6 UTP Copper Cable



Suggested Label Solutions for TIA/EIA-606-A Compliance				
Cable Part Number	Laser/Ink Jet Desktop Printer Label	TDP43ME Thermal Transfer Desktop Printer Label	PanTher™ LS8E Hand-Held Printer Label	Cougar™ LS9 Hand-Held Printer Label
PUR6004**-UY PUP6004**-UY	S100X150YAJ	S100X150VATY	S100X150VAC	T100X000CBC-BK

For complete labeling solutions and product information, reference charts on pages O.1 – O.25.

cULus **Mini-Com**® **TX6**™ **PLUS UTP Jack Modules**

- Exceed ANSI/TIA-568-C.2 Category 6 and ISO 11801 2nd Edition Class E standards
- Meet requirements of IEEE 802.3af and IEEE 802.3at for PoE applications
- Each jack is 100% tested to ensure NEXT and RL performance and is individually serialized for traceability
- Color-coded, keyed jack modules mechanically and visually distinguish connections to prevent unintentional mating with unlike keyed or non-keyed modular plugs accommodating more discrete networks
- Utilize patent-pending enhanced Giga-TX™ Technology for jack terminations which optimizes performance by maintaining cable pair geometry and eliminating conductor untwist
- Contacts plated with 50 microinches of gold for superior performance
- No punchdown tool required; termination tool (EGJT) ensures conductors are fully terminated by utilizing a smooth forward motion without impact on critical internal components for maximum reliability
- Optional termination tool (TGJT) reduces termination time by 25%, ideal for high volume installations
- Can be re-terminated a minimum of twenty times
- White termination cap designates Category 6 performance and provides positive strain relief; helps control cable bend radius and securely retains wires
- Terminate 4-pair, 22 – 26 AWG, 100 ohm, solid or stranded twisted pair cable
- Universal termination cap is color-coded for T568A and T568B wiring schemes
- Accept 6 and 8-position modular plugs without damage
- Can be clearly identified with optional labels and icons
- Compatible with Mini-Com® Modular Patch Panels, Faceplates, and Surface Mount Boxes
- Optional RJ45 blockout device blocks out unauthorized access to jack modules and potentially harmful foreign objects, saving time and money associated with data security breaches, network downtime, repair, and hardware replacement
- Optional dust cap keeps out dust and debris while not in use



CJ688TGIW



CJK688TGBL

Part Number	Part Description	No. of Module Spaces	Color	Std. Pkg. Qty.	Std. Ctn. Qty.
Jack Module					
CJ688TGIW ‡	Category 6, RJ45, 8-position, 8-wire universal module.	1	Off White	1	50
Keyed Jack Module					
CJK688TGBL *	Keyed, Category 6, RJ45, 8-position, 8-wire universal module.	1	Black	1	50

‡For standard colors other than Off White, replace suffix IW (Off White) with EI (Electric Ivory), WH (White), AW (Arctic White), IG (International Gray), BL (Black), OR (Orange), RD (Red), BU (Blue), GR (Green), YL (Yellow), or VL (Violet).

*For standard colors other than Black, replace suffix BL (Black) with BU (Blue), RD (Red), YL (Yellow), GR (Green), or OR (Orange), each color representing a different keyed configuration.

Termination tools available on page B.97.

RJ45 blockout device available on page B.92.

Dust cap available on page B.97.

Contact Customer Service for bulk packaged jack modules.

To ensure optimal performance, Panduit recommends use with other Panduit TX6™ PLUS components.

Keyed Geometry



Black Key



Red Key

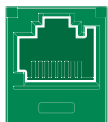

Green Key

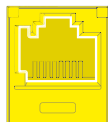

Yellow Key



Orange Key



Blue Key



Black Key



Red Key



Green Key



Yellow Key



Orange Key



Blue Key

Mini-Com® TX6™ PLUS Corrosive Resistant UTP Jack Module

- Injected gel and polymer material reduce area of exposed electrical contacts providing improved long term performance in corrosive environments
- Exceed requirements of ANSI/TIA-568-C.2 Category 6, IEEE 802.3an-2006, and ISO 11801 Class E channel standards
- Meet requirements of IEEE 802.3af and IEEE 802.3at for PoE applications
- Each jack is 100% tested to ensure NEXT and RL performance and is individually serialized for traceability
- Utilizes patent-pending enhanced Giga-TX™ Technology for jack termination which optimizes performance by maintaining cable pair geometry and eliminating conductor untwist
- Contacts plated with 50 microinches of gold for superior performance
- No punchdown tool required; termination tool (EGJT) ensures conductors are fully terminated by utilizing a smooth forward motion without impact on critical internal components for maximum reliability
- Optional termination tool (TGJT) reduces termination time by 25%, ideal for high volume installations
- Can be re-terminated a minimum of twenty times
- White termination cap designates Category 6 performance and provides positive strain relief; helps control cable bend radius and securely retains wires
- Terminates 4-pair, 22 — 26 AWG, 100 ohm, solid or stranded twisted pair cable
- Universal termination cap is color-coded for T568A and T568B wiring schemes
- Accepts 6 and 8-position modular plugs without damage
- Can be clearly identified with optional labels and icons
- Compatible with Mini-Com® Modular Patch Panels, Faceplates and Surface Mount Boxes
- Optional RJ45 blockout device blocks out unauthorized access to jack modules and potentially harmful foreign objects, saving time and money associated with data security breaches, network downtime, repair, and hardware replacement
- Optional dust cap keeps out dust and debris while not in use
- Optional RJ45 lock-in device blocks unauthorized removal of cable, IP phone, other networking equipment, or critical connection



Part Number	Part Description	No. of Module Spaces	Color‡	Std. Pkg. Qty.	Std. Ctn. Qty.
CJE688TGIW	Category 6, RJ45, 8-position, 8-wire, universal, corrosive resistant UTP jack module	1	Off White	1	50

‡For standard colors other than Off White, replace suffix IW (Off White) with WH (White), BL (Black), RD (Red), or BU (Blue).

RJ45 blockout device available on page B.92.

Dust cap available on page B.97.

Component Labels for Mini-Com® TX6™ PLUS UTP Jack Modules



Suggested Label Solutions for TIA/EIA-606-A Compliance				
Module Part Number	Laser/Ink Jet Desktop Printer Label	TDP43ME Thermal Transfer Desktop Printer Label	PanTher™ LS8E Hand-Held Printer Label	Cougar™ LS9 Hand-Held Printer Label
All TX6™ PLUS Jack Modules	C138X019FJJ	C138X019YPT	C138X019FJC	T019X000FJC-BK

For complete labeling solutions and product information, reference charts on pages O.1 – O.25.



Mini-Com[®] Ultimate ID[®] TX6[™] PLUS Modular Patch Panel Kits

- Supplied with black Mini-Com[®] TX6[™] PLUS Jack Modules
- Include color-coded termination caps
- Front access faceplates in panels
- Available with or without labels
- Can be clearly identified with the PanTher[™] LS8E or Cougar[™] LS9 Hand-Held Thermal Transfer Printers



UICMPPKA6G24BL



UICMPPK6G24BL

Part Number	Part Description	Labels Required	No. of Rack Spaces [^]	Std. Pkg. Qty.	Std. Ctn. Qty.
Mini-Com[®] Ultimate ID[®] Angled Modular Patch Panel Kit					
UICMPPKA6G24BL	24-port UICMPPA24BL angled patch panel with 24 CJ688TGGBL jack modules.	Six 4-Port	1	1	10
Mini-Com[®] Ultimate ID[®] Modular Patch Panel Kit					
UICMPPK6G24BL	24-port UICMPP24BL patch panel with 24 CJ688TGGBL jack modules.	Six 4-Port	1	1	10

[^]One rack space = 1.75" (44.45mm).
Includes #12-24 and metric M6 screws to mount the patch panel to the rack.
Ultimate ID[®] Labels can be found on pages O.11 – O.19.



Mini-Com[®] TX6[™] PLUS Modular Patch Panel Kits

- Supplied with black Mini-Com[®] TX6[™] PLUS Jack Modules
- Include color-coded termination caps
- Front access faceplates in panels
- Available with or without labels
- Include EGJT termination tool



CPPKA6G24WBL



CPPKLA6G24WBL



CPPK6G24WBL



CPPKL6G24WBL

Part Number	Part Description	No. of Rack Spaces [^]	Std. Pkg. Qty.	Std. Ctn. Qty.
Mini-Com[®] Angled Modular Patch Panel Kits – with Labels				
CPPKA6G24WBL	24-port angled patch panel with 24 CJ688TGGBL jack modules.	1	1	10
CPPKLA6G24WBL	24-port CPPLA24WBL angled patch panel with 24 CJ688TGGBL jack modules.	1	1	10
Mini-Com[®] Modular Patch Panel Kits – with Labels				
CPPK6G24WBL	24-port CPP24WBL patch panel with 24 CJ688TGGBL jack modules.	1	1	10
CPPKL6G24WBL	24-port CPPL24WBL patch panel with 24 CJ688TGGBL jack modules.	1	1	10

[^]One rack space = 1.75" (44.45mm).
Includes #12-24 and metric M6 screws to mount the patch panel to the rack.



DP6™ PLUS UTP Patch Panels

- Exceed ANSI/TIA-568-C.2 Category 6 and ISO 11801 2nd Edition Class E standards
- Meet requirements of IEEE 802.3af and IEEE 802.3at for PoE applications
- Each port is 100% tested to ensure NEXT and RL performance and is individually serialized to support traceability
- Utilize 110 punchdown termination on back panel and includes retention cap for each port
- Each port contains a universal label that is color-coded for T568A and T568B wiring schemes
- Angled versions allow for higher density applications by easily routing the patch cords to each side of the panel eliminating the need for horizontal cable management
- Terminate 4-pair, 22 – 26 AWG, 100 ohm, solid or stranded twisted pair cable
- Mount to standard EIA 19" rack or 23" racks with optional extender bracket
- Write-on areas for port and panel identification
- Can be clearly identified with labels and icons
- Optional label kits (DPLK24 and DPLK48) contain adhesive label holder and labels for easy port and panel identification



DPA24688TGY



DPA48688TGY



DP12688TGY



DP24688TGY



DP48688TGY

Part Number	Part Description	No. of Rack Spaces [^]	Std. Pkg. Qty.	Std. Ctn. Qty.
DP6™ PLUS Angled Patch Panels				
DPA24688TGY	24-port, angled, Category 6, patch panel with 24 RJ45, 8-position, 8-wire ports.	1	1	10
DPA48688TGY	48-port, angled, Category 6, patch panel with 48 RJ45, 8-position, 8-wire ports.	2	1	10

Part Number	Part Description	No. of Rack Spaces [^]	Std. Pkg. Qty.	Std. Ctn. Qty.
DP6™ PLUS Flat Patch Panels				
DP12688TGY	12-port, Category 6, patch panel with twelve RJ45, 8-position, 8-wire ports. Mounts to 89D wall mount bracket.	—	1	10
DP24688TGY	24-port, Category 6, patch panel with 24 RJ45, 8-position, 8-wire ports.	1	1	10
DP48688TGY	48-port, Category 6, patch panel with 48 RJ45, 8-position, 8-wire ports.	2	1	10

[^]One rack space = 1.75" (44.45mm).
M6 and #12-24 mounting screws included.
Replaceable punchdown modules available, part number DRJ688TGBL.
Termination tool (PDT110) available on page B.91.
89D wall mount bracket available on page B.72.

Component Labels for DP6™ PLUS UTP Patch Panels



Suggested Label Solutions for TIA/EIA-606-A Compliance				
Patch Panel Part Number	Laser/Ink Jet Desktop Printer Label	TDP43ME Thermal Transfer Desktop Printer Label	PanTher™ LS8E Hand-Held Printer Label	Cougar™ LS9 Hand-Held Printer Label
All Patch Panels on this Page	C379X030FJJ	C379X030YPT	C379X030FJC	T031X000FJC-BK

For complete labeling solutions and product information, reference charts on pages O.1 – O.25.

Mini-Com[®] Category 6 UTP Coupler Module

- Designed to exceed performance requirements of the ANSI/TIA-568-C.2 Category 6 and ISO 11801 2nd Edition Class E channel standards
- Meet requirements of IEEE 802.3af and IEEE 802.3at for PoE applications
- RJ45 8-position, 8-wire female to RJ45 8-position, 8-wire female pass-through module provides fast and easy plug and play connection of 6 and 8-position RJ45 patch cords
- No tools required
- 100% tested to ensure NEXT and RL performance and is individually serialized for traceability
- Contacts plated with 50 microinches of gold for superior performance
- Can be clearly identified with optional labels and icons
- Compatible with Mini-Com[®] Modular Patch Panels and Faceplates; not suitable for surface mount box applications
- Optional RJ45 blockout device blocks out unauthorized access to jack modules and potentially harmful foreign objects, saving time and money associated with data security breaches, network downtime, repair, and hardware replacement
- Optional dust cap keeps out dust and debris while not in use



Part Number	Part Description	No. of Module Spaces	Color‡	Std. Pkg. Qty.	Std. Ctn. Qty.
CC688IW	Category 6, RJ45, 8-position, 8-wire universal coupler module.	1	Off White	1	50

‡For other colors replace suffix IW (Off White) with BL (Black).
Acts as one connecting hardware component in channel.
RJ45 blockout device available on page B.92.
Dust cap available on page B.97.
TX6™ PLUS UTP Patch Cords available on page B.34.

Component Labels for Mini-Com[®] Category 6 UTP Coupler Module



Suggested Label Solutions for TIA/EIA-606-A Compliance

Module Part Number	Laser/Ink Jet Desktop Printer Label	TDP43ME Thermal Transfer Desktop Printer Label	PanTher™ LS8E Hand-Held Printer Label	Cougar™ LS9 Hand-Held Printer Label
CC688IW	C138X019FJJ	C138X019YPT	C138X019FJC	T019X000FJC-BK

For complete labeling solutions and product information, reference charts on pages O.1 – O.25.

Category 6 Coupler Patch Panel

- Coupler panel ports provide fast and easy plug and play connection of 6 and 8-position RJ45 patch cords
- No tools required
- Designed to exceed performance requirements of the ANSI/TIA-568-C.2 Category 6 and ISO 11801 2nd Edition Class E channel standards
- Contacts plated with 50 microinches of gold for superior performance
- Can be clearly identified with optional labels and icons
- Mounts to standard EIA 19" rack or 23" racks with optional extender bracket

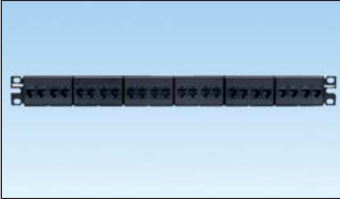

Part Number	Part Description	No. of Rack Spaces [^]	Std. Pkg. Qty.	Std. Ctn. Qty.
CP24688BL	24-port, Category 6, patch panel with 24 pre-installed RJ45 Category 6 channel compliant couplers.	1	1	10

[^]One rack space = 1.75" (44.45mm).
M6 and #12-24 mounting screws included.
Each coupler module acts as one connecting hardware component in a channel.
TX6™ PLUS UTP Patch Cords available on page B.34.

Component Labels for Category 6 Coupler Patch Panel

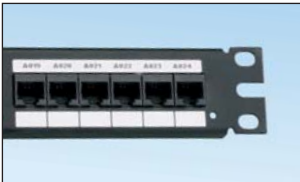

Suggested Label Solutions for TIA/EIA-606-A Compliance				
Part Number	Laser/Ink Jet Desktop Printer Label	TDP43ME Thermal Transfer Desktop Printer Label	PanTher™ LS8E Hand-Held Printer Label	Cougar™ LS9 Hand-Held Printer Label
CP24688BL	C252X030FJJ	C252X030YPT	C252X030FJC	T031X000FJC-BK

For complete labeling solutions and product information, reference charts on pages O.1 – O.25.



TX6™ PLUS UTP Patch Cords

- Exceed ANSI/TIA-568-C.2 Category 6 and ISO 11801 Class E standards
- Meet requirements of IEEE 802.3af and IEEE 802.3at for PoE applications
- Each patch cord is 100% performance tested to component limits and wired T568B
- Color-coded, keyed modular plugs mechanically and visually distinguish connections to prevent unintentional mating with unlike keyed or non-keyed jack modules accommodating more discrete networks
- Constructed of Category 6, 24 AWG UTP stranded cable and TX6™ PLUS Modular Plugs; plug contacts plated with 50 microinches of gold for superior performance
- Plug meets all applicable ANSI/TIA/EIA-968-A requirements and exceeds IEC 60603-7 specifications
- Slender strain relief boot provides easy access in high density applications
- Plug uses an integral pair manager to optimize performance and consistency by reducing untwisting of conductors within the plug
- Perform in center of TIA/EIA component range, ensuring interoperability and excellent performance
- Labels on patch cords provide identification of performance level, length, and quality control number
- Patented tangle-free latch prevents snags and provides easy release, saving time on frequent moves, adds, and changes
- Optional patch cord color bands snap on and off individual patch cables offering endless color-coding options
- Optional RJ45 plug lock-in device blocks unauthorized removal of cable, IP phone, other networking equipment, or critical connection
- Third party tested for Category 6 component compliance

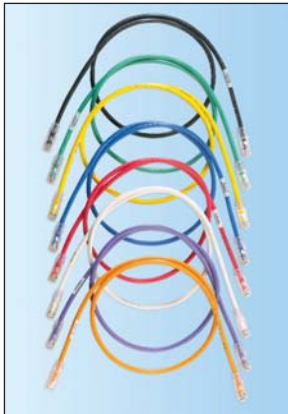

Part Number	Part Description	Length (Ft.)	Cable Color	Std. Pkg. Qty.	Std. Ctn. Qty.
Patch Cord					
UTPSP3Y‡	Category 6, UTP patch cord with TX6™ PLUS Modular Plugs on each end.	3	Off White	1	10

Keyed Patch Cord					
UTPKSP3BL*	Keyed, Category 6, UTP patch cord with TX6™ PLUS Keyed Modular Plug on one end and TX6™ PLUS Non-Keyed Modular Plug on the other end.	3	Black	1	10

‡For lengths 1 to 20 feet (increments of one foot) and 25, 30, 35, 40 feet change the length designation in the part number to the desired length. For standard cable colors other than Off White, add suffix BL (Black), BU (Blue), GR (Green), RD (Red), YL (Yellow), OR (Orange), or VL (Violet) before Y at the end of the part number. For example, the part number for a blue 15-foot patch cord is UTPSP15BUY.

*For lengths other than 3 feet (5, 7, 10, 14 feet) change the length designation in the part number to the desired length. For standard cable colors other than Black, replace suffix BL (Black) with BU (Blue), RD (Red), YL (Yellow), GR (Green), or OR (Orange), each color representing a different keyed configuration. Contact customer service for universal reference patch cords.

Patch cord color bands available on page B.96.

RJ45 plug lock-in device available on page B.94.

To ensure optimal performance, Panduit recommends use with other Panduit TX6™ PLUS components.

Labels for TX6™ PLUS UTP Patch Cords

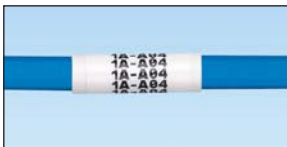

Suggested Label Solutions for TIA/EIA-606-A Compliance				
Patch Cord Part Number	Laser/Ink Jet Desktop Printer Label	TDP43ME Thermal Transfer Desktop Printer Label	PanTher™ LS8E Hand-Held Printer Label	Cougar™ LS9 Hand-Held Printer Label
All Patch Cords	S100X150YAJ	S100X150VATY	S100X150VAC	T100X000CBC-BK

For complete labeling solutions and product information, reference charts on pages O.1 – O.25.



TX6™ PLUS UTP Modular Plug

- Meets all applicable ANSI/TIA-968-A requirements and exceeds IEC 60603-7 specifications
- Meet requirements of IEEE 802.3af and IEEE 802.3at for PoE applications
- Used in UTPSP series patch cords providing Category 6 performance
- Patented tangle-free latch prevents snags and provides easy release saving time on frequent moves, adds, and changes
- Integral pair manager optimizes performance and consistency by reducing untwist at plug
- Contacts plated with 50 microinches of gold for superior performance
- Terminates 24 AWG, 100 ohm, stranded or solid conductor with max. conductor insulation diameter of 0.041 in.



Part Number	Part Description	Std. Pkg. Qty.	Std. Ctn. Qty.
SP688-C	8-position, 8-wire modular plug.	100	1000

To ensure optimal performance, Panduit recommends use with other Panduit TX6™ PLUS components. MPT5-8AS crimp tool required for termination, available on page B.98.

cUL us **Mini-Com**® **TX6**™ **PLUS Shielded Jack Modules**

- Exceed requirements of ANSI/TIA-568-C.2 Category 6, IEEE 802.3an-2006, and ISO 11801 Class E channel standards
- Meet requirements of IEEE 802.af and IEEE 802.3at for PoE applications
- Each jack is 100% tested to ensure NEXT and RL performance and is individually serialized for traceability
- Color-coded, keyed jack modules mechanically and visually distinguish connections to prevent unintentional mating with unlike keyed or non-keyed modular plugs accommodating more discrete networks
- Utilize patent-pending enhanced Giga-TX™ Technology for jack terminations which optimizes performance by maintaining cable pair geometry and eliminating conductor untwist
- Fully grounded and bonded to patch panel when installed in Panduit All Metal Modular Patch Panel
- Contacts plated with 50 microinches of gold for superior performance
- No punchdown tool required; termination tool (EGJT) ensures conductors are fully terminated by utilizing a smooth forward motion without impact on critical internal components for maximum reliability
- Optional termination tool (TGJT) reduces termination time by 25%, ideal for high volume installations
- Can be re-terminated a minimum of twenty times
- Off white termination cap designates Category 6 performance and provides positive strain relief; helps control cable bend radius and securely retains wires
- Terminate 4-pair, 22 – 26 AWG, 100 ohm, solid or stranded shielded twisted pair cable
- Universal termination cap is color-coded for T568A and T568B wiring schemes
- Integrated strain relief with wire cap provides 360° conductive path for grounding
- 0.187 in. tab provides conductive path for grounding individual jacks
- Accept 6 and 8-position modular plugs without damage
- Can be clearly identified with optional labels and icons
- Compatible with Mini-Com® Modular Patch Panels, Faceplates, and Surface Mount Boxes
- Optional RJ45 blockout device blocks out unauthorized access to jack modules and potentially harmful foreign objects, saving time and money associated with data security breaches, network downtime, repair, and hardware replacement
- Optional dust cap keeps out dust and debris while not in use



CJS688TGY



CJSK688TGBL

Part Number	Part Description	No. of Module Spaces	Color	Std. Pkg. Qty.	Std. Ctn. Qty.
Jack Module					
CJS688TGY	Category 6, RJ45, 8-position, 8-wire universal shielded black module with integral shield.	1	Black	1	50
Keyed Jack Module					
CJSK688TGBL*	Keyed, Category 6, RJ45, 8-position, 8-wire universal shielded black module with integral shield.	1	Black	1	50

*For standard colors other than Black, replace suffix BL (Black) with BU (Blue), RD (Red), YL (Yellow), GR (Green), OR (Orange), VL (Violet), or GY (Gray), each color representing a different keyed configuration. Termination tools available on page B.97. Shield grounding requires proper installation of shielded jack module and the use of shielded patch cords and cable. All metal modular patch panels available on page B.72. For grounding shielded modules not installed in a shielded patch panel, see the shielded jack module grounding kit, CJSJK-XY on page M.23. RJ45 blockout device available on page B.97. Dust cap available on page B.97. To ensure optimal performance, Panduit recommends use with other Panduit TX6™ PLUS components. Contact customer service for bulk packaged jack modules.

 Mini-Com® TX6™ PLUS Shielded Jack Modules (continued)

Keyed Geometry



Black Key



Red Key



Green Key



Yellow Key



Orange Key



Blue Key



Violet Key



Intl. Gray Key



Black Key



Red Key



Green Key



Yellow Key



Orange Key



Blue Key



Violet Key



Intl. Gray Key

Component Labels for Mini-Com® TX6™ PLUS Shielded Jack Modules



Suggested Label Solutions for TIA/EIA-606-A Compliance

Module Part Number	Laser/Ink Jet Desktop Printer Label	TDP43ME Thermal Transfer Desktop Printer Label	PanTher™ LS8E Hand-Held Printer Label	Cougar™ LS9 Hand-Held Printer Label
All TX6™ PLUS Jack Modules	C138X019FJJ	C138X019YPT	C138X019FJC	T019X000FJC-BK

For complete labeling solutions and product information, reference charts on pages O.1 – O.25.

cUL_{us} TX6™ PLUS Shielded Modular Plug

- Meets all applicable ANSI/TIA-968-A requirements and exceeds IEC 60603-7 specifications
- Meet requirements of IEEE 802.3af and IEEE 802.3at for PoE applications
- Used in STP6X series patch cords providing Category 6 performance
- Patented tangle-free latch prevents snags and provides easy release saving time on frequent moves, adds, and changes
- Slender strain relief boot provides easy access in high density applications
- Integral pair manager optimizes performance and consistency by reducing untwist at plug
- Contacts plated with 50 microinches of gold for superior performance
- Shielded plug housing provides conductive path for grounding
- Terminates 24 – 26 AWG, 100 ohm, stranded or solid shielded cable with max. conductor insulation diameter of 0.040 in.



Part Number	Part Description	Std. Pkg. Qty.	Std. Ctn. Qty.
SPS688-C	8-position, 8-wire shielded modular plug.	100	1000

To ensure optimal performance, Panduit recommends use with other Panduit TX6™ PLUS components. MPT5-8AS crimp tool required for termination. Termination tool available on page B.98.



TX5500™ Enhanced Category 5e UTP Copper Cable

- Exceeds requirements of ANSI/TIA-568-C.2 Category 5e and ISO 11801 2nd Edition Class D channel standards
- Exceeds requirements of ANSI/TIA-568-C.2 and IEC 61156-5 Category 5e component standards
- Third party tested to Category 5e channel compliance
- Meets requirements of IEEE 802.3af and IEEE 802.3at for PoE applications
- Cable diameter: Riser 0.225 in. (5.7mm) nominal, Plenum 0.193 in. (4.9mm) nominal
- Installation temperature range: 32°F to 122°F (0°C to 50°C)
- Operating temperature range: 14°F to 140°F (-10°C to 60°C)
- Channel characterized to 450 MHz, 350 MHz above the standard
- Descending length cable markings enable easy identification of remaining cable which reduces installation time and cable scrap
- Cable supplied in an easy payout box



PUR5504WH-UY

Part Number	Part Description	Color‡	Std. Pkg. Qty. (Ft.)	Std. Ctn. Qty. (Ft.)
Riser				
PUR5504BU-UY	Enhanced Category 5e, riser (CMR), 4-pair, UTP copper cable. Copper conductors are 24 AWG construction with polyolefin (PE) insulation. Conductors are twisted in pairs and protected by a flame-retardant PVC jacket.	Blue	1000	39000
Plenum				
PUP5504BU-UY	Enhanced Category 5e, plenum (CMP), 4-pair, UTP copper cable. Copper conductors are 24 AWG construction with FEP insulation. Conductors are twisted in pairs and placed in a low smoke, flame-retardant PVC jacket.	Blue	1000	39000

‡For standard colors other than Blue, replace BU (Blue) with WH (White), YL (Yellow), or IG (International Gray). Contact Customer Service for other color options.
Order number of pieces required, in multiples of 13,000 feet.

Labels for TX5500™ Enhanced Category 5e UTP Copper Cable



Suggested Label Solutions for TIA/EIA-606-A Compliance				
Cable Part Number	Laser/Ink Jet Desktop Printer Label	TDP43ME Thermal Transfer Desktop Printer Label	PanTher™ LS8E Hand-Held Printer Label	Cougar™ LS9 Hand-Held Printer Label
PUR5504**-UY PUP5504**-UY	S100X150YAJ	S100X150VATY	S100X150VAC	T100X000CBC-BK

For complete labeling solutions and product information, reference charts on pages O.1 – O.25.

Mini-Com® TX5e™ UTP Jack Modules

- Exceed ANSI/TIA-568-C.2 Category 5e and ISO 11801 2nd Edition Class D standards
- Meet requirements of IEEE 802.3af and IEEE 802.3at for PoE applications
- Each jack is 100% tested to ensure NEXT and RL performance and is individually serialized for traceability
- Color-coded, keyed jack modules mechanically and visually distinguish connections to prevent unintentional mating with unlike keyed or non-keyed modular plugs accommodating more discrete networks
- Utilize patent-pending enhanced Giga-TX™ Technology for jack terminations which optimizes performance by maintaining cable pair geometry and eliminating conductor untwist
- Contacts plated with 50 microinches of gold for superior performance
- No punchdown tool required; termination tool (EGJT) ensures conductors are fully terminated by utilizing a smooth forward motion without impact on critical internal components for maximum reliability
- Optional termination tool (TGJT) reduces termination time by 25%, ideal for high volume installations

- Can be re-terminated a minimum of twenty times
- Red termination cap designates Category 5e performance and provides positive strain relief; helps control cable bend radius and securely retains wires
- Terminate 4-pair, 22 – 26 AWG, 100 ohm, solid or stranded twisted pair cable
- Universal termination cap is color-coded for T568A and T568B wiring schemes
- Accept 6 and 8-position modular plugs without damage
- Can be clearly identified with optional labels and icons
- Compatible with Mini-Com® Modular Patch Panels, Faceplates, and Surface Mount Boxes
- Optional RJ45 blockout device blocks out unauthorized access to jack modules and potentially harmful foreign objects, saving time and money associated with data security breaches, network downtime, repair, and hardware replacement
- Optional dust cap keeps out dust and debris while not in use



CJ5E88TGIW



CJK5E88TGBL

Part Number	Part Description	No. of Module Spaces	Color‡	Std. Pkg. Qty.	Std. Ctn. Qty.
Jack Module					
CJ5E88TGIW‡	Category 5e, RJ45, 8-position, 8-wire universal jack module.	1	Off White	1	50

Keyed Jack Module					
CJK5E88TGBL*	Keyed, Category 5e, RJ45, 8-position, 8-wire universal module.	1	Black	1	50

‡For standard colors other than Off White, replace suffix IW (Off White) with EI (Electric Ivory), WH (White), AW (Arctic White), IG (International Gray), BL (Black), OR (Orange), RD (Red), BU (Blue), GR (Green), YL (Yellow) or VL (Violet).

*For standard colors other than Black, replace suffix BL (Black) with BU (Blue), RD (Red), YL (Yellow), GR (Green) or OR (Orange), each color representing a different keyed configuration. Termination tools available on page B.97.

RJ45 blockout device available on page B.92.

Dust cap available on page B.97.

Contact customer service for bulk packaged jack modules.

Mini-Com® TX5e™ UTP Jack Modules (continued)

Keyed Geometry



Black
Key



Red
Key



Green
Key



Yellow
Key



Orange
Key



Blue
Key



Black
Key



Red
Key



Green
Key



Yellow
Key



Orange
Key



Blue
Key

Component Labels for Mini-Com® TX5e™ UTP Jack Modules



Suggested Label Solutions for TIA/EIA-606-A Compliance				
Module Part Number	Laser/Ink Jet Desktop Printer Label	TDP43ME Thermal Transfer Desktop Printer Label	PanTher™ LS8E Hand-Held Printer Label	Cougar™ LS9 Hand-Held Printer Label
All TX5e™ Jack Modules	C138X019FJJ	C138X019YPT	C138X019FJC	T019X000FJC-BK

For complete labeling solutions and product information, reference charts on pages O.1 – O.25.

Mini-Com® TX5e™ Corrosive Resistant UTP Jack Module

- Injected gel and polymer material reduce area of exposed electrical contacts providing improved long term performance in corrosive environments
- Exceed requirements of ANSI/TIA-568-C.2 Category 5e, IEEE 802.3an-2006, and ISO 11801 Class D channel standards
- Exceed requirements of ANSI/TIA-568-C.2 Category 5e and IEC 61156-5 Category 5e component standards
- Meet requirements of IEEE 802.3af and IEEE 802.3at for PoE applications
- Each jack is 100% tested to ensure NEXT and RL performance and is individually serialized for traceability
- Utilizes patent-pending enhanced Giga-TX™ Technology for jack terminations which optimizes performance by maintaining cable pair geometry and eliminating conductor untwist
- Contacts plated with 50 microinches of gold for superior performance
- No punchdown tool required; termination tool (EGJT) ensures conductors are fully terminated by utilizing a smooth forward motion without impact on critical internal components for maximum reliability
- Optional termination tool (TGJT) reduces termination time by 25%, ideal for high volume installations
- Can be re-terminated a minimum of twenty times
- Red termination cap designates Category 5e performance and provides positive strain relief; helps control cable bend radius and securely retains wires
- Terminates 4-pair, 22 – 26 AWG, 100 ohm, solid or stranded twisted pair cable
- Universal termination cap is color-coded for T568A and T568B wiring schemes
- Accepts 6 and 8-position modular plugs without damage
- Can be clearly identified with optional labels and icons
- Compatible with Mini-Com® Modular Patch Panels, Faceplates, and Surface Mount Boxes
- Optional RJ45 blockout device blocks out unauthorized access to jack modules and potentially harmful foreign objects, saving time and money associated with data security breaches, network downtime, repair, and hardware replacement
- Optional dust cap keeps out dust and debris while not in use



Part Number	Part Description	No. of Module Spaces	Color‡	Std. Pkg. Qty.	Std. Ctn. Qty.
CJE5E88TGIW	Corrosive resistant, Category 5e, RJ45, 8-position, 8-wire universal module.	1	Off White	1	50

‡For standard colors other than Off White, replace suffix IW (Off White) with WH (White), BL (Black), RD (Red), or BU (Blue).

Termination tools available on page B.97.

RJ45 blockout device available on page B.92.

Dust cap available on page B.97.

Component Labels for Mini-Com® TX5e™ Corrosive Resistant UTP Jack Module



Suggested Label Solutions for TIA/EIA-606-A Compliance

Part Number	Laser/Ink Jet Desktop Printer Label	TDP43ME Thermal Transfer Desktop Printer Label	PanTher™ LS8E Hand-Held Printer Label	Cougar™ LS9 Hand-Held Printer Label
CJE5E88TG**	C138X019FJJ	C138X019YPT	C138X019FJC	T019X000FJC-BK

For complete labeling solutions and product information, reference charts on pages O.1 – O.25.



DP5e™ UTP Patch Panels

- Exceed ANSI/TIA-568-C.2 Category 5e and ISO 11801 Class D standards
- Meet requirements of IEEE 802.3af and IEEE 802.3at for PoE applications
- Each port is 100% tested to ensure NEXT and RL performance and is individually serialized to support traceability
- Utilize 110 termination on back panel and includes retention cap for each port
- Each port contains a universal label that is color-coded for T568A and T568B wiring schemes
- Contacts plated with 50 microinches of gold for superior performance

- Angled versions allow for higher density installations by easily routing the patch cords to each side of the panel eliminating the need for horizontal cable management
- Terminate 4 pair, 22 - 26 AWG, 100 ohm, solid or stranded twisted pair cable
- Mount to standard EIA 19" rack or 23" racks with optional extender bracket
- Write-on areas for port and panel identification
- Can be clearly identified with labels and icons
- Optional label kits (DPLK24 and DPLK48) contain adhesive label holder and labels for easy port and panel identification



DPA245E88TGY

PATENTED



DPA485E88TGY



DP125E88TGY



DP245E88TGY



DP485E88TGY

Part Number	Part Description	No. of Rack Spaces [^]	Std. Pkg. Qty.	Std. Ctn. Qty.
DP5e™ Angled Patch Panels				
DPA245E88TGY	24-port, Category 5e, patch panel with 24 RJ45, 8-position, 8-wire ports.	1	1	10
DPA485E88TGY	48-port, Category 5e, patch panel with 48 RJ45, 8-position, 8-wire ports.	2	1	10

Part Number	Part Description	No. of Rack Spaces [^]	Std. Pkg. Qty.	Std. Ctn. Qty.
DP5e™ Flat Patch Panels				
DP125E88TGY	12-port, Category 5e, patch panel with twelve RJ45, 8-position, 8-wire ports. Mounts to 89D wall mount bracket.	—	1	10
DP245E88TGY	24-port, Category 5e, patch panel with 24 RJ45, 8-position, 8-wire ports.	1	1	10
DP485E88TGY	48-port, Category 5e, patch panel with 48 RJ45, 8-position, 8-wire ports.	2	1	10

[^]One rack space = 1.75" (44.45mm).
M6 and #12-24 mounting screws included.
Replaceable punchdown modules available, part number DRJ5E88TGBL.
Termination tool (PDT110) available on page B.91.
89D wall mount bracket available on page B.72.

Component Labels for DP5e™ UTP Patch Panels



Suggested Label Solutions for TIA/EIA-606-A Compliance

Patch Panel Part Number	Laser/Ink Jet Desktop Printer Label	TDP43ME Thermal Transfer Desktop Printer Label	PanTher™ LS8E Hand-Held Printer Label	Cougar™ LS9 Hand-Held Printer Label
All Patch Panels on this page	C379X030FJJ	C379X030YPT	C379X030FJC	T031X000FJC-BK

For complete labeling solutions and product information, reference charts on pages O.1 – O.25.

cUL^{us} Mini-Com® Category 5e UTP Coupler Module

- Designed to exceed performance requirements of the ANSI/TIA-568-C.2 Category 5e and ISO 11801 2nd Edition Class D channel standards
- Meet requirements of IEEE 802.3af and IEEE 802.3at for PoE applications
- RJ45 8-position, 8-wire female to RJ45 8-position, 8-wire female pass-through module provides fast and easy plug and play connection of 6 and 8-position RJ45 patch cords
- No tools required
- 100% tested to ensure NEXT and RL performance and is individually serialized for traceability
- Contacts plated with 50 microinches of gold for superior performance
- Can be clearly identified with optional labels and icons
- Compatible with Mini-Com® Modular Patch Panels and Faceplates; not suitable for surface mount box applications
- Optional RJ45 blockout device blocks out unauthorized access to jack modules and potentially harmful foreign objects, saving time and money associated with data security breaches, network downtime, repair, and hardware replacement
- Optional dust cap keeps out dust and debris while not in use



Part Number	Part Description	No. of Module Spaces	Color‡	Std. Pkg. Qty.	Std. Ctn. Qty.
CC5E88IW	Category 5e, RJ45, 8-position, 8-wire universal coupler module.	1	Off White	1	50

‡For other colors replace suffix IW (Off White) with BL (Black).
Acts as one connecting hardware component in channel.
RJ45 blockout device available on page B.92.
Dust cap available on page B.97.
TX5e™ UTP Patch Cords available on page B.46.

Component Labels for Mini-Com® Category 5e UTP Coupler Module



Suggested Label Solutions for TIA/EIA-606-A Compliance

Part Number	Laser/Ink Jet Desktop Printer Label	TDP43ME Thermal Transfer Desktop Printer Label	PanTher™ LS8E Hand-Held Printer Label	Cougar™ LS9 Hand-Held Printer Label
CC5E88IW	C138X019FJJ	C138X019YPT	C138X019FJC	T019X000FJC-BK

For complete labeling solutions and product information, reference charts on pages O.1 – O.25.



Category 5e Coupler Patch Panel

- Coupler panel ports provide fast and easy plug and play connection of 6 and 8-position RJ45 patch cords
- No tools required
- Designed to exceed ANSI/TIA-568-C.2 Category 5e and all ISO 11801 2nd Edition Class D channel standard requirements at swept frequencies up to 100 MHz
- Contacts plated with 50 microinches of gold for superior performance
- Can be clearly identified with optional labels and icons
- Mounts to standard EIA 19" rack or 23" racks with optional extender bracket

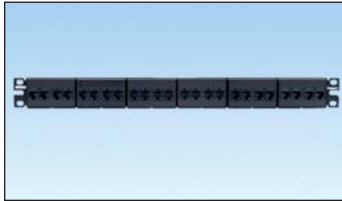

Part Number	Part Description	No. of Rack Spaces [^]	Std. Pkg. Qty.	Std. Ctn. Qty.
CP245E88BLY	24-port, Category 5e, patch panel with 24 pre-installed RJ45 Category 5e channel compliant couplers.	1	1	10

[^]One rack space = 1.75" (44.45mm).
M6 and #12-24 mounting screws included.
Each coupler module acts as one connecting hardware component in a channel.
TX5e™ UTP Patch Cords available on page B.46.

Component Labels for Category 5e Coupler Patch Panel

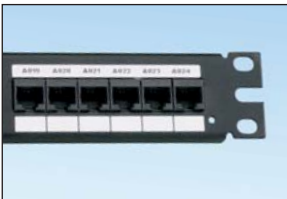

Suggested Label Solutions for TIA/EIA-606-A Compliance				
Part Number	Laser/Ink Jet Desktop Printer Label	TDP43ME Thermal Transfer Desktop Printer Label	PanTher™ LS8E Hand-Held Printer Label	Cougar™ LS9 Hand-Held Printer Label
CP245E88BLY	C252X030FJJ	C252X030YPT	C252X030FJC	T031X000FJC-BK

For complete labeling solutions and product information, reference charts on pages O.1 – O.25.

UL[®] US TX5e™ UTP Patch Cords

- Exceed ANSI/TIA-568-C.2 Category 5e and ISO 11801 Class D standards
- Meet requirements of IEEE 802.3af and IEEE 802.3at for PoE applications
- Color-coded, keyed modular plugs mechanically and visually distinguish connections to prevent unintentional mating with unlike keyed or non-keyed jack modules accommodating more discrete networks
- Each patch cord is 100% performance tested to component limits and wired to T568A
- Constructed of Category 5e, 24 AWG UTP stranded cable and Pan-Plug® Modular Plugs; plug contacts plated with 50 microinches of gold for superior performance
- Plug meets all applicable ANSI/TIA/EIA-968-A requirements and exceeds IEC 60603-7 specifications
- Patented tangle-free latch prevents snags and provides easy release, saving time on frequent moves, adds, and changes
- Labels on patch cords provide identification of performance level, length, and quality control number
- Optional patch cord color bands snap on and off individual patch cables offering endless color-coding options
- Optional RJ45 plug lock-in device blocks unauthorized removal of cable, IP phone, other networking equipment, or critical connection
- Third party tested to Category 5e component compliance

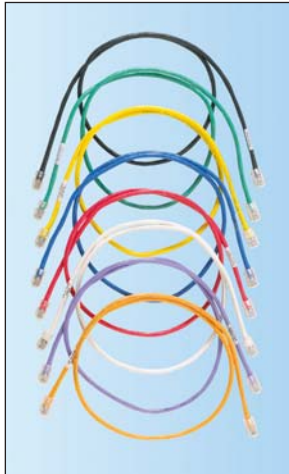

Part Number	Part Description	Length (Ft.)	Cable Color	Std. Pkg. Qty.	Std. Ctn. Qty.
Patch Cords					
UTPCH3Y‡	Category 5e, UTP patch cord with Pan-Plug™ Modular Plugs on each end.	3	Off White	1	10
Keyed Patch Cords					
UTPKCH3BL*	Keyed, Category 5e, UTP patch cord with Pan-Plug™ Keyed Modular Plug on one end and Pan-Plug™ Non-Keyed Modular Plug on the other end.	3	Black	1	10

‡For lengths 1 to 20 feet (increments of one foot) and 25, 30, 35, 40 feet change the length designation in the part number to the desired length. For standard cable colors other than Off White, add suffix BL (Black), BU (Blue), GR (Green), RD (Red), YL (Yellow), OR (Orange), or VL (Violet) before the Y in the part number. For example, the part number for a blue 15-foot patch cord is UTPCH15BUY.

*For lengths other than 3 feet (5, 7, 10, 14 feet) change the length designation in the part number to the desired length. For standard cable colors other than Black, replace suffix BL (Black) with BU (Blue), RD (Red), YL (Yellow), GR (Green), or OR (Orange), each color representing a different keyed configuration.

Contact customer service for universal reference patch cords.

Patch cord color bands available on page B.91.

RJ45 plug lock-in device available on page B.94.

Labels for TX5e™ UTP Patch Cords



Suggested Label Solutions for TIA/EIA-606-A Compliance				
Patch Cord Part Number	Laser/Ink Jet Desktop Printer Label	TDP43ME Thermal Transfer Desktop Printer Label	PanTher™ LS8E Hand-Held Printer Label	Cougar™ LS9 Hand-Held Printer Label
All Patch Cords	S100X150YAJ	S100X150VATY	S100X150VAC	T100X000CBC-BK

For complete labeling solutions and product information, reference charts on pages O.1 – O.25.



Pan-Plug® Category 5e UTP Modular Plugs

- Meet all applicable ANSI/TIA-968-A requirements and exceeds IEC 60603-7 specifications
- Meet requirements of IEEE 802.3af and IEEE 802.3at for PoE applications
- Used in UTPCH series patch cords providing Category 5e performance
- Patented tangle-free plug latch prevents snags and provides easy release saving time on frequent moves, adds, and changes
- Simplified termination requires no loading bar; guide ramp facilitates easy conductor insertion and termination
- Contacts plated with 50 microinches of gold for superior performance
- Terminate 24 AWG, 100 ohm, stranded or solid conductor with max. conductor insulation diameter of 0.040"



Part Number	Part Description	Std. Pkg. Qty.	Std. Ctn. Qty.
MP588-L	8-position, 8-wire modular plug.	50	250
MP588-C	8-position, 8-wire modular plug.	100	1000
MP588-M	8-position, 8-wire modular plug.	1000	5000

MPT5-8AS crimp tool required for termination, available on page B.98.



TX5500™ Category 5e F/UTP Shielded Copper Cable

- Exceeds requirements of ANSI/TIA-568-C.2 Category 5e and ISO 11801 2nd Edition Class D channel standards
- Exceeds requirements of ANSI/TIA-568-C.2 Category 5e and IEC 61156-5 Category 5e component standards
- Meets requirements of IEEE 802.3af and IEEE 802.3at for PoE applications
- Cable diameter: Riser 0.241 inch (6.1 mm), Plenum 0.229 inch (5.8mm)
- Installation temperature range: 32°F to 122°F (0°C to 50°C)
- Operating temperature range: -4°F to 140°F (-20°C to 60°C)
- Descending length cable markings enable easy identification of remaining cable which reduces installation time and cable scrap
- Cable supplied on a reel

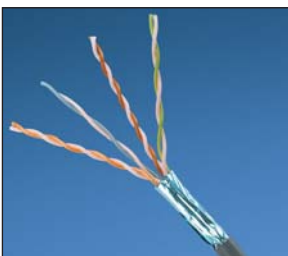

Part Number	Part Description	Cable Color	Std. Pkg. Qty.	Std. Ctn. Qty.
Riser				
PFR5504BU-UY	Category 5e, riser (CMR), 4-pair, F/UTP copper cable. Copper conductors are 24 AWG construction with polyethylene insulation. Conductors are twisted in pairs, surrounded by an overall polyester aluminum foil with a stranded copper drain wire and protected by a flame-retardant PVC jacket.	Blue	1000	20000
Riser				
PPF5504BU-UY	Category 5e, plenum (CMP), 4-pair, F/UTP copper cable. Copper conductors are 24 AWG construction with FEP insulation. Conductors are twisted in pairs, surrounded by an overall polyester aluminum foil with stranded copper drain wire and protected by a low smoke flame-retardant PVC jacket.	Blue	1000	20000

For other colors, replace BU (Blue) with WH (White), IG (International Gray), BL (Black), GR (Green), OR (Orange), RD (Red), VL (Violet), or YL (Yellow).
Order number of pieces required, in multiples of 5,000 feet.

cUL **us**  **Mini-Com® TX5e™ Shielded Jack Modules**

- Exceed requirements of ANSI/TIA-568-C.2 Category 5e, IEEE 802.3an-2006, and ISO 11801 Class D channel standards
- Exceed requirements of ANSI/TIA-568-C.2 Category 5e and IEC 61156-5 Category 5e component standards
- Meet requirements of IEEE 802.3af and IEEE 802.3at for PoE applications
- Each jack is 100% tested to ensure NEXT and RL performance and is individually serialized for traceability
- Utilize patent-pending enhanced Giga-TX™ Technology for jack terminations which optimizes performance by maintaining cable pair geometry and eliminating conductor untwist
- Fully grounded and bonded to patch panel when installed in Panduit All Metal Modular Patch Panel
- Contacts plated with 50 microinches of gold for superior performance
- No punchdown tool required; termination tool (EGJT) ensures conductors are fully terminated by utilizing a smooth forward motion without impact on critical internal components for maximum reliability
- Optional termination tool (TGJT) reduces termination time by 25%, ideal for high volume installations
- Can be re-terminated a minimum of twenty times
- Red termination cap designates Category 5e performance and provides positive strain relief; helps control cable bend radius and securely retains wires
- Terminate 4-pair, 22 – 26 AWG, 100 ohm, solid or stranded shielded twisted pair cable
- Universal termination cap is color-coded for T568A and T568B wiring schemes
- Integrated strain relief with wire cap provides 360° conductive path for grounding
- 0.187 in. tab provides conductive path for grounding individual jacks
- Accept 6 and 8-position modular plugs without damage
- Can be clearly identified with optional labels and icons
- Compatible with Mini-Com® Modular Patch Panels, Faceplates, and Surface Mount Boxes
- Optional RJ45 blockout device blocks out unauthorized access to jack modules and potentially harmful foreign objects, saving time and money associated with data security breaches, network downtime, repair, and hardware replacement
- Optional dust cap keeps out dust and debris while not in use



CJS5E88TGY



CJSK5E88TGBL

Part Number	Part Description	No. of Module Spaces	Cable Color	Std. Pkg. Qty.	Std. Ctn. Qty.
Jack Module					
CJS5E88TGY	Category 5e, RJ45, 8-position, 8-wire universal shielded black module with integrated shield.	1	Black	1	50
Keyed Jack Module					
CJSK5E88TGBL*	Keyed, Category 5e, RJ45, 8-position, 8-wire universal shielded black module with integrated shield.	1	Black	1	50

*For standard colors other than Black, replace suffix BL (Black) with BU (Blue), RD (Red), YL (Yellow), GR (Green), OR (Orange), VL (Violet), or GY (Gray), each color representing a different keyed configuration. Termination tools available on page B.97.

Shield grounding requires proper installation of shielded jack module and the use of shielded patch cords and cable.

All metal modular patch panels available on page B.73.

For grounding shielded modules not installed in a shielded patch panel, see the shielded jack module grounding kit, CJSJK-XY on page M.23.

RJ45 blockout device available on page B.92.

Dust cap available on page B.97.

Contact customer service for bulk packaged jack modules.

  **Mini-Com® TX5e™ Shielded Jack Modules (continued)**

Keyed Geometry



Black Key



Red Key



Green Key



Yellow Key



Orange Key



Blue Key



Violet Key



Intl. Gray Key



Black Key



Red Key



Green Key



Yellow Key



Orange Key



Blue Key



Violet Key



Intl. Gray Key

Component Labels for Mini-Com® TX5e™ Shielded Jack Modules



Suggested Label Solutions for TIA/EIA-606-A Compliance				
Module Part Number	Laser/Ink Jet Desktop Printer Label	TDP43ME Thermal Transfer Desktop Printer Label	PanTher™ LS8E Hand-Held Printer Label	Cougar™ LS9 Hand-Held Printer Label
All TX5e™ Shielded Jack Modules	C138X019FJJ	C138X019YPT	C138X019FJC	T019X000FJC-BK

For complete labeling solutions and product information, reference charts on pages O.1 – O.25.

cUL us TX5e™ Shielded Patch Cords

- Exceed ANSI/TIA-568-C.2 Category 5e and ISO 11801 Class D standards
- Meet requirements of IEEE 802.3af and IEEE 802.3at for PoE applications
- Color-coded, keyed modular plugs mechanically and visually distinguish connections to prevent unintentional mating with unlike keyed or non-keyed jack modules accommodating more discrete networks
- Each patch cord is 100% performance tested to component limits and wired T568A
- Constructed of Category 5e, 26 AWG, STP stranded, LSZH/CM cable and Pan-Plug™ Shielded Modular Plugs; plug contacts plated with 50 microinches of gold for superior performance
- Plug meets all applicable ANSI/TIA/EIA-968-A requirements and exceeds IEC 60603-7 specifications
- Patented tangle-free latch prevents snags and provides easy release, saving time on frequent moves, adds, and changes
- Labels on patch cords provide identification of performance level, length, and quality control number
- Optional patch cord color bands snap on and off individual patch cables offering endless color-coding options
- Optional RJ45 plug lock-in device blocks unauthorized removal of cable, IP phone, other networking equipment, or critical connection

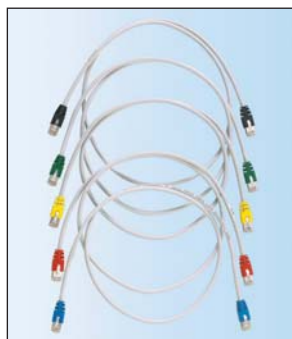

Part Number	Part Description	Length (m)	Boot Color	Cable Color	Std. Pkg. Qty.	Std. Ctn. Qty.
Patch Cords						
STPCH1MBBL‡	Category 5e, shielded patch cord with Pan-Plug® Shielded Modular Plugs on each end.	1	Black	International Gray	1	10

Part Number	Part Description	Length (Ft.)	Boot Color	Cable Color	Std. Pkg. Qty.	Std. Ctn. Qty.
Keyed Patch Cords						
STPKCH3BL	Keyed, Category 5e, shielded patch cord with Pan-Plug® Keyed Shielded Modular Plug on one end and Pan-Plug® Non-Keyed Shielded Modular Plug on the other end.	3	Black	International Gray	1	10

‡For lengths 1 to 10 meters (increments of one meter) and 0.5, 1.5, 2.5, 15, 20, 25, 30, 35, 40 meters change the length designation in the part number to the desired length. For boot colors other than Black, replace suffix BL (Black) with BU (Blue), GR (Green), RD (Red), or YL (Yellow). For example, the part number for a 15 meter patch cord with blue boots is STPCH15MBBU.

*For lengths other than 3 feet (5, 7, 10, 14 feet) change the length designation in the part number to the desired length. For boot colors other than Black, replace suffix BL (Black) with BU (Blue), RD (Red), YL (Yellow), GR (Green), or OR (Orange), each color representing a different keyed configuration. Contact customer service for universal reference patch cords.

Patch cord color bands available on page B.96.
RJ45 plug lock-in device available on page B.94.

Labels for TX5e™ Shielded Patch Cords



Suggested Label Solutions for TIA/EIA-606-A Compliance				
Patch Cord Part Number	Laser/Ink Jet Desktop Printer Label	TDP43ME Thermal Transfer Desktop Printer Label	PanTher™ LS8E Hand-Held Printer Label	Cougar™ LS9 Hand-Held Printer Label
All Patch Cords	S100X150YAJ	S100X150VATY	S100X150VAC	T100X000CBC-BK

For complete labeling solutions and product information, reference charts on pages O.1 – O.25.

Pan-Plug® Category 5e Shielded Modular Plug

- Meets all applicable ANSI/TIA-968-A requirements and exceeds IEC 60603-7 specifications
- Meet requirements of IEEE 802.3af and IEEE 802.3at for PoE applications
- Used in STPCH series patch cords providing Category 5e performance
- Patented tangle-free latch prevents snags and provides easy release saving time on frequent moves, adds, and changes
- Simplified termination requires no loading bar, guide ramp facilitates easy conductor insertion and termination
- Contacts plated with 50 microinches of gold for superior performance
- Shielded plug housing provides conductive path for grounding
- Terminates 24 – 26 AWG 100 ohm stranded or solid shielded cable with max. conductor insulation diameter of 0.040 in.



Part Number	Part Description	Std. Pkg. Qty.	Std. Ctn. Qty.
MPS588-C	8-position, 8-wire shielded modular plug.	100	1000

To ensure optimal performance, Panduit recommends use with other Panduit Category 5e components. MPT5-8AS crimp tool required for termination, available on page B.98.



TX5500™ Category 5e 25-Pair UTP Copper Cable

- Exceeds requirements of ANSI/TIA-568-C.2 Category 5e and ISO 11801 2nd Edition Class D channel standards
- Exceeds requirements of ANSI/TIA-568-C.2 and IEC 61156-5 Category 5e component standards
- Meets requirements of IEEE 802.3af and 802.3at for PoE applications
- Cable diameter: Riser 0.511 in. (12.9mm) nominal, Plenum 0.455 in. (11.6mm) nominal
- Installation temperature range: 32°F to 122°F (0°C to 50°C)
- Operating temperature range: -4°F to 167°F (-20°C to 75°C)
- Descending length cable markings enable easy identification of remaining cable which reduces installation time and cable scrap
- Cable supplied on a reel



PUR5525IG-UY

Part Number	Part Description	Color‡	Std. Pkg. Qty. (Ft.)	Std. Ctn. Qty. (Ft.)
Riser				
PUR5525IG-UY	Category 5e riser (CMR) 25-pair UTP copper cable. Copper conductors are 24 AWG construction with HDPE insulation. Conductors are twisted in pairs and placed in a flame-retardant PVC jacket.	International Gray	1000	3000
Plenum				
PUP5525IG-UY	Category 5e plenum (CMP) 25-pair UTP copper cable. Copper conductors are 24 AWG construction with FEP insulation. Conductors are twisted in pairs and placed in a low smoke, flame-retardant, fluoropolymer jacket.	International Gray	1000	3000

‡For standard colors other than IG (International Gray), replace IG with BU (Blue) or WH (White). Order number of pieces required, in multiples of Standard Carton Quantity (Pallet).

Labels for TX5500™ Category 5e 25-Pair UTP Copper Cable



Suggested Label Solutions for TIA/EIA-606-A Compliance

Module Part Number	Laser/Ink Jet Desktop Printer Label	TDP43ME Thermal Transfer Desktop Printer Label	PanTher™ LS8E Hand-Held Printer Label	Cougar™ LS9 Hand-Held Printer Label
PUP5525IG-UY PUR5525IG-UY	S100X400YAJ	S100X400VATY	S100X400VAC	T100X000CBC-BK

For complete labeling solutions and product information, reference charts on pages O.1 – O.25.

Data-Patch™ 10/100BASE-T Patch Panels

- Category 5e rated in the channel when used with Category 5e 25-pair cable assemblies
- Consist of female telco 50 pin/25 pair connectors with hook and loop fasteners wired per RJ21 industry standard for backward compatibility
- Each port is wired for 10/100BASE-T Ethernet utilizing pins 1, 2 and 3, 6
- Does not require use of a punchdown tool
- Mount to standard EIA 19" rack or 23" racks with optional extender bracket
- Write-on areas for port and panel identification
- Optional label kits (DPLK24 and DPLK48) contain adhesive label holder and labels for easy port and panel identification
- Can be clearly identified with labels and icons



DP24584TV25Y



DP48584TV25Y

Part Number	Part Description	No. of Rack Spaces [^]	Std. Pkg. Qty.	Std. Ctn. Qty.
DP24584TV25Y	24-port, Category 5e, patch panel with 24 RJ45 ports wired to two RJ21 Telco connectors.	1	1	10
DP48584TV25Y	48-port, Category 5e, patch panel with 48 RJ45 ports wired to four RJ21 Telco connectors.	2	1	10

[^]One rack space = 1.75" (44.45mm).
M6 and #12-24 mounting screws included.
For use with Data-Patch™ 10/100BASE-T Cable Assemblies on page B.55.

Component Labels for Data-Patch™ 10/100BASE-T Patch Panels



Suggested Label Solutions for TIA/EIA-606-A Compliance

Patch Panel Part Number	Laser/Ink Jet Desktop Printer Label	TDP43ME Thermal Transfer Desktop Printer Label	PanTher™ LS8E Hand-Held Printer Label	Cougar™ LS9 Hand-Held Printer Label
DP24584TV25Y DP48584TV25Y	C379X030FJJ	C379X030YPT	C379X030FJC	T031X000FJC-BK

For complete labeling solutions and product information, reference charts on pages O.1 – O.25.

Data-Patch™ Category 5e RJ21 to RJ45 Patch Panel

- Designed to exceed ANSI/TIA-568-C.2 Category 5e and ISO 11801 2nd Edition Class D standards
- Consist of female telco 50-pin/25-pair connectors with hook and loop fasteners wired per RJ21 industry standard for backward compatibility
- Each RJ45 port is fully wired for 10/100/1000BASE-T Ethernet performance utilizing all 8 pins
- Does not require use of a punchdown tool
- Mounts to standard EIA 19" rack or 23" racks with optional extender bracket
- Write-on areas for port and panel identification
- Can be clearly identified with labels and icons
- Optional label kits (DPLK24 and DPLK48) contain adhesive label holder and labels for easy port and panel identification



DPA245E88TV25



DPA485E88TV25



DP245E88TV25



DP485E88TV25

Part Number	Part Description	No. of Rack Spaces [^]	Std. Pkg. Qty.	Std. Ctn. Qty.
Data-Patch™ 10/100/1000BASE-T RJ21 to RJ45 Angled Patch Panels				
DPA245E88TV25	24-port angled, Category 5e, RJ45, 8-pin, fully wired to 4-port RJ21 connector panel.	1	1	10
PATENTED				
DPA485E88TV25	48-port angled, Category 5e, RJ45, 8-pin, fully wired to 8-port RJ21 connector panel.	2	1	10
Data-Patch™ 10/100/1000BASE-T RJ21 to RJ45 Flat Patch Panels				
DP245E88TV25	24-port, Category 5e, RJ45, 8-pin, fully wired to 4-port RJ21 connector panel.	1	1	10
DP485E88TV25	48-port, Category 5e, RJ45, 8-pin, fully wired to 8-port RJ21 connector panel.	2	1	10

[^]One rack space = 1.75" (44.45mm).
M6 and #12-24 mounting screws included.
Data-Patch™ 10/100/1000BASE-T Cable Assemblies available on page B.55.

Component Labels for Data-Patch™ Category 5e RJ21 to RJ45 Patch Panel

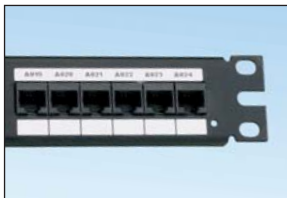

Suggested Label Solutions for TIA/EIA-606-A Compliance				
Part Number	Laser/Ink Jet Desktop Printer Label	TDP43ME Thermal Transfer Desktop Printer Label	PanTher™ LS8E Hand-Held Printer Label	Cougar™ LS9 Hand-Held Printer Label
DPA245E88TV25	C379X030FJJ	C379X030YPT	C379X030FJC	T031X000FJC-BK
DPA485E88TV25				
DP245E88TV25				
DP485E88TV25				

For complete labeling solutions and product information, reference charts on pages O.1 – O.25.



Data-Patch™ 10/100/1000BASE-T Cable Assemblies

- Category 5e rated 25-pair connectorized cable assemblies are enhanced performance patch cords featuring 25-pair Category 5e solid cable with Category 5e, 25-pair RJ21 plugs on either end
- System also includes Category 5e rated 25-pair hydra with Category 5e, 25-pair male connectors on one end and six Pan-Plug® Modular Plugs on the other end
- System also include Category 5e rated RJ21 to MRJ21 with Category 5e 25-pair male connector on one end and MRJ21 male connector on the other
- All cords are 100% tested for wiring sequence and continuity



UTPCH8**25Y

Part Number	Part Description	Length (Ft.)‡	Std. Pkg. Qty.	Std. Ctn. Qty.
UTPCH8SR25Y	RJ21 plug to RJ21 plug, straight, 110° right orientation.	8	1	10
UTPCH8SL25Y	RJ21 plug to RJ21 plug, straight, 110° left orientation.	8	1	10
UTPCH8L25Y	RJ21 plug to RJ21 plug, both 110° left orientation.	8	1	10
UTPCH8R25Y	RJ21 plug to RJ21 plug, both 110° right orientation.	8	1	10
UTPCH8LR25Y	RJ21 plug to RJ21 plug, 110° left, 110° right orientation.	8	1	10
UTPCH86PP25	RJ21 plug to six Pan-Plug® Modular Plugs, straight.	8	1	10
UTPCH8SMRJ25	MRJ21 male connector to RJ21 connector, straight.	8	1	10

‡For lengths 6, 10, 15 and 20 replace 8 in part number for desired length. For example, the part number for a 15 foot straight and right 25-pair connectorized cable assembly is UTPCH15SR25Y.

Labels for Data-Patch™ 10/100/1000BASE-T Cable Assemblies



Suggested Label Solutions for TIA/EIA 606-A Compliance				
Cable Assemblies Part Number	Laser/Ink Jet Desktop Printer Label	TDP43ME Thermal Transfer Desktop Printer Label	PanTher™ LS8E Hand-Held Printer Label	Cougar™ LS9 Hand-Held Printer Label
All UTPCH8 Cable Assemblies on this page	S100X400YAJ	S100X400VATY	S100X400VAC	T100X000CBC-BK

For complete labeling solutions and product information, reference charts on pages O.1 – O.25.

RJ45 – HD68 and RJ45 – VHD68 SCSI Angled Patch Panel and Kits

- Used for console management of selected switching equipment
- Each port 100% electrically tested
- Angled patch panel is available individually or kitted with cable assemblies
- Female 68-pin sockets on panel meet ANSI T 10.1302D SCSI Parallel Interface-3 (SPI-3) standard
- Mount to standard EIA 19" rack or 23" racks with optional extender bracket
- Pre-printed numbers above each port for easy identification

**TPK1A32R88S68Y**

Part Number	Part Description	No. of Rack Spaces [^]	Std. Pkg. Qty.	Std. Ctn. Qty.
TPA32R88S68Y	32-port angled patch panel with 32 RJ45 ports wired to four 68-pin SCSI connectors.	1	1	10
TPK1A32R88S68Y	32-port angled patch panel with 32 RJ45 ports wired to four 68-pin SCSI connectors kitted with four cable assemblies each 3 ft. long with 68-pin DB68 male plugs on both ends.	1	1	10
TPK2A32R88S68	32-port angled patch panel with 32 RJ45 ports wired to four 68 pin SCSI connectors kitted with four cable assemblies each 6 ft. long with 68-pin DB68 male plug on one end, and 68-pin VHD68 male plug on the other.	1	1	10

[^]One rack space = 1.75" (44.45mm).
M6 and #12 – 24 mounting screws included.

Component Labels for RJ45 – HD68 and RJ45 – VHD68 SCSI Angled Patch Panel and Kits



Suggested Label Solutions for TIA/EIA-606-A Compliance

Patch Panel Part Number	Laser/Ink Jet Desktop Printer Label	TDP43ME Thermal Transfer Desktop Printer Label	PanTher™ LS8E Hand-Held Printer Label	Cougar™ LS9 Hand-Held Printer Label
TPA32R88S68 TPK1A32R88S68	C379X030FJJ	C379X030YPT	C379X030FJC	T031X000FJC-BK

For complete labeling solutions and product information, reference charts on pages O.1 – O.25.



Mini-Com® Mini-Jack™ Category 3 UTP Jack Modules

- Patented lead frame termination style ensures twists are maintained to within 1/2"
- No punchdown tool required, optional termination tool (CJT-X) ensures conductors are fully terminated
- Termination cap provides excellent strain relief; helps control cable bend radius and securely retains wires
- Clear, removable termination cap provides easy troubleshooting
- Terminate 4-pair 24 and 22 AWG 100 ohm solid unshielded twisted pair cable
- Accept 6 and 8-position modular plugs without damage
- White colored module base designates Category 3 performance
- Can be clearly identified with optional labels and icons
- Compatible with Mini-Com® Modular Patch Panels, Faceplates, and Surface Mount Boxes
- Optional RJ45 blockout device blocks out unauthorized access to jack modules and potentially harmful foreign objects, saving time and money associated with data security breaches, network downtime, repair, and hardware replacement
- Optional dust cap keeps out dust and debris while not in use



CJ88**Y

CJ66U**Y



CJ66**Y

CJ64**Y

Part Number	Part Description	No. of Module Spaces	Color‡	Std. Pkg. Qty.	Std. Ctn. Qty.
CJ88IWY	Category 3, 8-position, 8-wire universal module.	1	Off White	1	50
CJ66UIWY	Category 3, 6-position, 6-wire USOC module.	1	Off White	1	50
CJ66IWY	Category 3, 6-position, 6-wire universal module.	1	Off White	1	50
CJ64IWY	Category 3, 6-position, 4-wire universal module.	1	Off White	1	50

‡For standard colors other than Off White, replace suffix IW (Off White) with EI (Electric Ivory), WH (White), IG (International Gray), YL (Yellow), or BL (Black).
Termination tools available on page B.97.

Component Labels for Mini-Com® Mini-Jack™ Category 3 UTP Jack Modules



Suggested Label Solutions for TIA/EIA-606-A Compliance

Module Part Number	Laser/Ink Jet Desktop Printer Label	TDP43ME Thermal Transfer Desktop Printer Label	PanTher™ LS8E Hand-Held Printer Label	Cougar™ LS9 Hand-Held Printer Label
All UTP Category 3 Jack Modules	C138X019FJJ	C138X019YPT	C138X019FJC	T019X000FJC-BK

For complete labeling solutions and product information, reference charts on pages O.1 – O.25.

Mini-Com[®] BAS Connector Module

- Standard field bus connector terminates up to three 18 – 22 AWG connectors or shielded/unshielded cable
- No punchdown tool required, terminates with screwdriver
- Common declaration point for BAS networks and low voltage power for building systems
- Compatible with Mini-Com[®] Modular Patch Panels, Faceplates, and Surface Mount Boxes



Part Number	Part Description	No. of Module Spaces	Color‡	Std. Pkg. Qty.	Std. Ctn. Qty.
CMBRS485OR	Module supplied with 22 AWG min/18 AWG max connector.	2	Orange	1	10

‡For other colors replace suffix OR (Orange) with BL (Black), BU (Blue), GR (Green), RD (Red), or YL (Yellow).



Mini-Com[®] Blank Module

- Secures opening to prevent tampering
- Compatible with Mini-Com[®] Modular Patch Panels, Faceplates, and Surface Mount Boxes



Part Number	Part Description	No. of Module Spaces	Color‡	Std. Pkg. Qty.	Std. Ctn. Qty.
CMBIW-X	1-position, reserves space for future use.	1	Off White	10	50

‡For other colors replace suffix IW (Off White) with EI (Electric Ivory), WH (White), IG (International Gray), or BL (Black).



Mini-Com[®] F-Type Module

- Typical use in CATV applications
- Accepts RG-6 and RG-59 coaxial cable
- Compatible with Mini-Com[®] Modular Patch Panels, Faceplates, and Surface Mount Boxes



Part Number	Part Description	No. of Module Spaces	Color‡	Std. Pkg. Qty.	Std. Ctn. Qty.
CMFIW	Module supplied with 75 ohm industry standard F-type coupler.	1	Off White	1	10

‡For other colors replace suffix IW (Off White) with EI (Electric Ivory), WH (White), IG (International Gray), or BL (Black).



Mini-Com® Self-Terminating F-Type Module

- Eliminates need for termination cap on connector
- Automatically puts 75 ohm load on cable run when cable is disconnected
- Reduces noise and interference on the line
- Compatible with Mini-Com® Modular Patch Panels, Faceplates, and Surface Mount Boxes
- Accepts RG-6 and RG-59 coaxial cable
- Rated 2GHz



Part Number	Part Description	No. of Module Spaces	Color‡	Std. Pkg. Qty.	Std. Ctn. Qty.
CMFSRIWY	Module supplied with 75 ohm self-terminating F-type coupler.	1	Off White	1	10

‡For other colors replace suffix IW (Off White) with EI (Electric Ivory), WH (White), IG (International Gray), or BL (Black).

Mini-Com® 15-Pin High-Density D-Subminiature Module

- Field terminable module features 15-pin screw terminal
- Dual module configuration allows it to be installed in Mini-Com® Faceplates (plastic and stainless steel)
- SVGA compatible
- Compatible with select Mini-Com® Modular Patch Panels, Faceplates, and Surface Mount Boxes



Part Number	Part Description	No. of Module Spaces	Color‡	Std. Pkg. Qty.	Std. Ctn. Qty.
CMD15HDIWY	2-position module supplied with one 15-pin DB connector mounted to a printed circuit board; terminates on site.	2	Off White	1	10

‡For other colors replace suffix IW (Off White) with EI (Electric Ivory), WH (White), IG (International Gray), or BL (Black).



Mini-Com® Module Base for D-Subminiature Connectors

- Accepts 9-pin or 15-pin high-density connector, male or female, solder or crimp type (connector not included)
- Compatible with select Mini-Com® Modular Patch Panels, Faceplates, and Surface Mount Boxes



Part Number	Part Description	No. of Module Spaces	Color‡	Std. Pkg. Qty.	Std. Ctn. Qty.
CMDBIW-X	2-position module base which accepts 9-pin and 15-pin high density D-subminiature connectors.	2	Off White	10	100

‡For other colors replace suffix IW (Off White) with EI (Electric Ivory), WH (White), IG (International Gray), or BL (Black).

D-Subminiature Inserts

- Used in audio and video applications
- Compatible with classic and executive faceplate frames



CHD9CIWY



CHD15HDCIWY



CHD15HDSCIWY

Part Number	Part Description	Color‡	Std. Pkg. Qty.	Std. Ctn. Qty.
CHD9CIWY	1/3 insert with 9-pin female to female coupler.	Off White	1	10
CHD15HDCIWY	1/3 insert with 15-pin high density female to female coupler; SVGA capable.	Off White	1	10
CHD15HDSCIWY	1/3 insert with one 15-pin DB connector mounted to a printed circuit board; terminates on site; SVGA capable.	Off White	1	10

‡For other colors, replace suffix IW (Off White) with EI (Electric Ivory), WH (White), IG (International Gray), or BL (Black).

Compatible with Classic and Executive Faceplate Frames on page G.14.

Component Labels for Mini-Com® D-Subminiature Inserts



Suggested Label Solutions for TIA/EIA-606-A Compliance

Faceplate Part Number	Laser/Ink Jet Desktop Printer Label	TDP43ME Thermal Transfer Desktop Printer Label	PanTher™ LS8E Hand-Held Printer Label	Cougar™ LS9 Hand-Held Printer Label
CHD9C**Y	C125X030FJJ	C125X030YPT	C125X030FJC	T031X000FJC-BK
CHD15HDC**Y				
CHD15HDSC**Y				

For complete labeling solutions and product information, reference charts on pages O.1 – O.25.

RCA 1/3 Inserts

- Used in audio and video applications

- Compatible with classic and executive faceplate frames



CHR3RGBIW



CHR3WYRIW

Part Number	Part Description	Color‡	Std. Pkg. Qty.	Std. Ctn. Qty.
CHR3RGBIW	1/3 insert with three RCA pass-through couplers. RCA insert colors are red, green, and blue. R,G,B component video.	Off White	1	10
CHR3WYRIW	1/3 insert with three RCA pass-through couplers. RCA insert colors are white, yellow, and red. Composite video and left and right stereo.	Off White	1	10

‡ For other colors, replace suffix IW (Off White) with EI (Electric Ivory), WH (White), or IG (International Gray). Compatible with Classic and Executive Faceplate Frames on page G.14.



Mini-Com® S-Video Punchdown Module

- Terminates 24 and 22 AWG solid or stranded conductors
- Utilizes Category 5e unshielded twisted pair or higher network cable facilitating a common, easy, and cost effective cabling installation; only four of the eight network cable conductors need to be terminated per cable
- Includes wire retention cap
- Compatible with Mini-Com® Modular Patch Panels, Faceplates, and Surface Mount Boxes



Part Number	Part Description	No. of Module Spaces	Color‡	Std. Pkg. Qty.	Std. Ctn. Qty.
CJSVIW	Module supplied with one S-Video connector.	1	Off White	1	10

‡For other colors replace suffix IW (Off White) with EI (Electric Ivory), WH (White), IG (International Gray), or BL (Black).

Punchdown termination tool available on page B.91.

Optional punchdown base (AVPDB), available on page B.97.

UL LISTED **SP** **Mini-Com[®] S-Video Pass-Through Module**

- Supplied with one 4-pin mini DIN coupler
- Compatible with Mini-Com[®] Modular Patch Panels, Faceplates, and Surface Mount Boxes

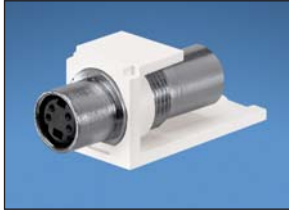

Part Number	Part Description	No. of Module Spaces	Color‡	Std. Pkg. Qty.	Std. Ctn. Qty.
CMSVCIWY	Module supplied with one S-video pass-through coupler.	1	Off White	1	10

‡For other colors replace suffix IW (Off White) with EI (Electric Ivory), WH (White), IG (International Gray), or BL (Black).

UL LISTED **SP** **Mini-Com[®] RCA 110 Punchdown Modules**

- Terminate 24 and 22 AWG solid or stranded conductors
- Utilize Category 5e unshielded twisted pair or higher network cable facilitating a common, easy, and cost effective cabling installation; only two of the eight network cable conductors need to be terminated per cable
- Include wire retention cap
- Compatible with Mini-Com[®] Modular Patch Panels, Faceplates, and Surface Mount Boxes

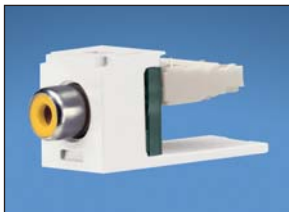

CJRY

Part Number	Part Description	No. of Module Spaces	Insert Color	Color‡	Std. Pkg. Qty.	Std. Ctn. Qty.
CJRYIW	Module supplied with one RCA connector with yellow insert.	1	Yellow	Off White	1	10
CJRRIW	Module supplied with one RCA connector with red insert.	1	Red	Off White	1	10
CJRWIW	Module supplied with one RCA connector with white insert.	1	White	Off White	1	10

‡For other colors replace suffix IW (Off White) with EI (Electric Ivory), WH (White), IG (International Gray), or BL (Black).

Punchdown termination tool available on page B.91.

Optional punchdown base (AVPDB), available on page B.97.

UL LISTED **SP** **Mini-Com[®] RCA Pass-Through Modules**

- Supplied with one RCA coupler
- Compatible with Mini-Com[®] Modular Patch Panels, Faceplates, and Surface Mount Boxes



CMRPR

Part Number	Part Description	No. of Module Spaces	Color‡	Std. Pkg. Qty.	Std. Ctn. Qty.
CMRPRIW	Module supplied with one RCA pass-through coupler with red insert.	1	Off White	1	10
CMRPYIW	Module supplied with one RCA pass-through coupler with yellow insert.	1	Off White	1	10
CMRPWIW	Module supplied with one RCA pass-through coupler with white insert.	1	Off White	1	10
CMRPBIW	Module supplied with one RCA pass-through coupler with blue insert.	1	Off White	1	10
CMRPGIW	Module supplied with one RCA pass-through coupler with green insert.	1	Off White	1	10

‡For other colors replace suffix IW (Off White) with EI (Electric Ivory), WH (White), IG (International Gray), or BL (Black).

Mini-Com® 3.5mm Stereo Connector and Coupler Modules

- Supplied with one solder-type connector or coupler
- Accept male plug found on typical stereo headsets
- Solder-type connector accepts 22 AWG stereo wire or smaller
- Insulation resistance exceeds 100 milli-ohms at DC 500V
- Rated for DC 12V., 1A
- Compatible with Mini-Com® Modular Patch Panels, Faceplates, and Surface Mount Boxes

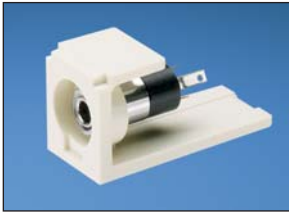

CM35MSS

Part Number	Part Description	No. of Module Spaces	Color‡	Std. Pkg. Qty.	Std. Ctn. Qty.
CM35MSSCIWY	3.5mm stereo coupler module.	1	Off White	1	10
CM35MSSSIW	Module supplied with one 3.5mm (1/8") stereo headset solder-type connector.	1	Off White	1	10

‡For other colors replace suffix IW (Off White) with EI (Electric Ivory), WH (White), IG (International Gray), or BL (Black).

Mini-Com® 5-Way Binding Post Modules

- Allow for easy installation of speaker wires, along with the ability to reconfigure speaker locations with greater ease
- Accept a variety of termination ends, including bare speaker wire (10 – 12 AWG) and banana plugs
- Gold plated and large metal contact area facilitates improved signal transmission
- Red or black stripe around collar of binding post clearly designates speaker connection
- Compatible with Mini-Com® Modular Patch Panels, Faceplates, and Surface Mount Boxes



CMBPBY

Part Number	Part Description	No. of Module Spaces	Color‡	Std. Pkg. Qty.	Std. Ctn. Qty.
CMBPBIWY	Module supplied with one 5-way binding post with black stripe.	1	Off White	1	10
CMBPRIWY	Module supplied with one 5-way binding post with red stripe.	1	Off White	1	10

‡For other colors, replace suffix IW (Off White) with EI (Electric Ivory) or WH (White).



Mini-Com[®] BNC Coax Coupler Modules

- Accept BNC plugs
- Available in 50 and 75 ohm versions

- Compatible with Mini-Com[®] Modular Patch Panels, Faceplates, and Surface Mount Boxes
- Accept RG-6 and RG-59 coaxial cable



CMBA75IWY

Part Number	Part Description	No. of Module Spaces	Color [‡]	Std. Pkg. Qty.	Std. Ctn. Qty.
CMBA75IWY	Module supplied with 75 ohm industry standard BNC coupler.	1	Off White	1	10
CMBAIWY	Module supplied with 50 ohm industry standard BNC coupler.	1	Off White	1	10

[‡]For other colors replace suffix IW (Off White) with EI (Electric Ivory), WH (White), IG (International Gray), or BL (Black).

Mini-Com[®] HDMI Coupler

- Delivers audio and video signals in digital format
- Supports Category 1 (standard) and Category 2 (high speed) HDMI cable
- Backwards compatible

- Compatible with select Mini-Com[®] Modular Patch Panels, Faceplates, and Surface Mount Boxes
- Length limitation determined by quality of the cable and type of device installed. Twinax cable recommended.



CMHDMIW

Part Number	Part Description	No. of Module Spaces	Color*	Std. Pkg. Qty.	Std. Ctn. Qty.
CMHDMIW	HDMI 1.3 Type A female to female Category 2 coupler module.	2	Off White	1	10

*For other colors replace suffix IW (Off White) with EI (Electric Ivory), WH (White), IG (International Gray), or BL (Black).

Mini-Com[®] USB Coupler

- Interface for transmitting data between devices such as scanners, digital cameras, printers, etc.
- Supports cable lengths up to 15 feet between devices

- Accepts USB 2.0 Patch Cords and is backwards compatible with USB 1.1 Patch Cords
- Compatible with all Mini-Com[®] Faceplates, Patch Panels and select Surface Mount Boxes



CMUSBAIW

Part Number	Part Description	No. of Module Spaces	Color*	Std. Pkg. Qty.	Std. Ctn. Qty.
CMUSBAIW	USB 2.0 female A to female A coupler module.	1	Off White	1	10

*For other colors replace suffix IW (Off White) with EI (Electric Ivory), WH (White), IG (International Gray), or BL (Black).



BNC Coupler Patch Panel

- Mounts to standard EIA 19" rack or 23" racks with optional extender bracket



CP48BNCBLY

Part Number	Part Description	No. of Rack Spaces [^]	Std. Pkg. Qty.	Std. Ctn. Qty.
CP48BNCBLY	48-port patch panel with 48 pre-installed 75 ohm BNC couplers.	1	1	10

[^]One rack space = 1.75" (44.45mm).
M6 and #12-24 mounting screws included.



Voice Patch Panel

- Consists of single female telco 50-pin/25-pair connector with hook and loop fasteners wired for common active voice equipment
- 24 RJ45 ports with pins 4 and 5 active in each port
- Telco connector with hook and loop fasteners accommodate 180, 110, or 90 degree patch cord connectors on back of patch panel
- Does not require use of a punchdown tool
- Mounts to standard EIA 19" rack or 23" racks with optional extender bracket
- Write-on areas available for port identification
- Can be clearly identified with optional labels and icons



VP24382TV25Y

Part Number	Part Description	No. of Rack Spaces [^]	Std. Pkg. Qty.	Std. Ctn. Qty.
VP24382TV25Y	24-port patch panel with 24 RJ45 ports wired to one RJ21 telco connector.	1	1	10

[^]One rack space = 1.75" (44.45mm).
M6 and #12-24 mounting screws included.

Component Labels for Voice Patch Panel



Suggested Label Solutions for TIA/EIA-606-A Compliance

Patch Panel Part Number	Laser/Ink Jet Desktop Printer Label	TDP43ME Thermal Transfer Desktop Printer Label	PanTher™ LS8E Hand-Held Printer Label	Cougar™ LS9 Hand-Held Printer Label
VP24382TV25Y	C379X030FJJ	C379X030YPT	C379X030FJC	T031X000FJC-BK

For complete labeling solutions and product information, reference charts on pages O.1 – O.25.

UL LISTED SP Mini-Com® Ultimate ID® Modular Patch Panels

- Ultimate ID® components are part of a complete system for identification designed to efficiently support TIA/EIA-606-A standard labeling requirements
- Angled patch panels facilitate proper bend radius control and minimize the need for horizontal cable managers
- Mount to standard EIA 19" rack or 23" racks with optional extender bracket
- Accept Mini-Com® Modules for UTP, fiber optic, and audio/video, which snap in and out for easy moves, adds, and changes
- Can be clearly identified with the PanTher™ LS8E or Cougar™ LS9 Hand-Held Thermal Transfer Printers
- Non-adhesive computer printable label sheets for desktop printers and write-on labels available
- Replacement label covers available
- Labels sold separately



UICMPPA24BLY

PATENTED



UICMPPA48BLY



UICMPP24BLY



UICMPP48BLY

Part Number	Part Description	No. of Rack Spaces [^]	Labels Required	Std. Pkg. Qty.	Std. Ctn. Qty.
Mini-Com® Ultimate ID® Angled Modular Patch Panels					
UICMPPA24BLY	24-port angled patch panel with six UICPPL4BL Mini-Com® Ultimate ID® Faceplates.	1	Six 4-Port	1	10
UICMPPA48BLY	48-port angled patch panel with twelve UICPPL4BL Mini-Com® Ultimate ID® Faceplates.	2	Twelve 4-Port	1	10

Mini-Com® Ultimate ID® Modular Patch Panels					
UICMPP24BLY	24-port patch panel with six UICPPL4BL Mini-Com® Ultimate ID® Faceplates.	1	Six 4-Port	1	10
UICMPP48BLY	48-port patch panel with twelve UICPPL4BL Mini-Com® Ultimate ID® Faceplates.	2	Twelve 4-Port	1	10

[^]One rack space = 1.75" (44.45mm).
M6 and #12-24 mounting screws included.
Modular patch panels shown include labels installed; labels sold separately.

UL LISTED SP Mini-Com® Ultimate ID® Patch Panel Faceplates

- Ultimate ID® components are part of a complete system for identification designed to efficiently support TIA/EIA-606-A standard labeling requirements; reference page A.17 for a complete system overview
- Accept Mini-Com® Modules for UTP, fiber optic, and audio/video, which snap in and out for easy moves, adds, and changes
- Allow for custom configuration of Ultimate ID™ Patch Panels
- Supplied with label covers; labels sold separately
- Two label pocket faceplate allows port and panel identification; also permits patch cords to be routed without blocking port ID
- Can be clearly identified with the PanTher™ LS8E or Cougar™ LS9 Hand-Held Thermal Transfer Printers
- Non-adhesive computer printable label sheets for desktop printers and write-on labels available
- Replacement label covers available



UICPP2L4BL



UICPPL4BL

Part Number	Part Description	Labels Required	Std. Pkg. Qty.	Std. Ctn. Qty.
UICPP2L4BL	Patch panel faceplate with two label pockets; accepts up to four Mini-Com® Modules.	Two 4-Port	1	10
UICPPL4BL	Patch panel faceplate with one label pocket; accepts up to four Mini-Com® Modules.	One 4-Port	1	10

Faceplates shown with labels installed, labels sold separately.
Ultimate ID® Labels can be found on pages O.11 and O.21.



Mini-Com® Flush Mount Modular Patch Panels

- Rear mounted faceplates allow modules to be flush with front of patch panel
- Accept Mini-Com® Modules for UTP, fiber optic, and audio/video, which snap in and out for easy moves, adds, and changes
- Pre-printed numbers above each port for easy identification

- White write-on areas for port and/or panel identification
- Mount to standard EIA 19" racks or 23" racks with optional extender brackets
- Angled patch panels facilitate proper bend radius control and minimize the need for horizontal cable managers



CPPA24FMWBLY

PATENTED



CPPA48FMWBLY



CPP24FMWBLY



CPP48FMWBLY

Part Number	Part Description	No. of Rack Spaces [^]	Std. Pkg. Qty.	Std. Ctn. Qty.
Mini-Com® Angled Flush Mount Modular Patch Panels				
CPPA24FMWBLY	Angled 24-port flush mount patch panel supplied with rear mounted faceplates.	1	1	10
CPPA48FMWBLY	Angled 48-port flush mount patch panel supplied with rear mounted faceplates.	2	1	10
Mini-Com® Flush Mount Modular Patch Panels				
CPP24FMWBLY	24-port flush mount patch panel supplied with rear mounted faceplates.	1	1	10
CPP48FMWBLY	48-port flush mount patch panel supplied with rear mounted faceplates.	2	1	10

[^]One rack space = 1.75" (44.45mm).
M6 and #12-24 mounting screws included.

Component Labels for Mini-Com® Flush Mount Modular Patch Panels

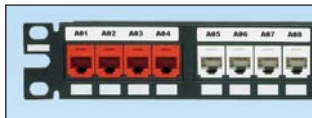

Suggested Label Solutions for TIA/EIA-606-A Compliance				
Patch Panel Part Number	Laser/Ink Jet Desktop Printer Label	TDP43ME Thermal Transfer Desktop Printer Label	PanTher™ LS8E Hand-Held Printer Label	Cougar™ LS9 Hand-Held Printer Label
All Flush Mount Patch Panels on this page	C252X030FJJ	C252X030YPT	C252X030FJC	T031X000FJC-BK

For complete labeling solutions and product information, reference charts on pages O.1 – O.25.



Mini-Com® High Density Modular Patch Panels

- Accept Mini-Com® Modules for UTP, fiber optic, and audio/video, which snap in and out for easy moves, adds, and changes
- Conserve valuable rack space, but may be limited to specific modules (UTP)
- Pre-printed numbers above each port for easy identification
- Mount to standard EIA 19" racks or 23" racks with optional extender brackets
- Angled patch panels facilitate proper bend radius control and minimize the need for horizontal cable managers
- Enhanced label version of 48-port high density patch panels only accept UTP modules



CPPA48HDWBL



CPPA72FMWBL



CPP48HDWBL



CPP72FMWBL



CPP48HDEWBL



CPP48HDVNSWBL

Part Number	Part Description	No. of Rack Spaces [^]	Std. Pkg. Qty.	Std. Ctn. Qty.
Mini-Com® Angled High Density Modular Patch Panels				
CPPA48HDWBL	48-port angled high density patch panel supplied with rear mounted faceplates (space not available for component labels).	1	1	10
CPPA72FMWBL	72-port angled high density flush mount patch panel supplied with rear mounted faceplates.	2	1	10
CPPA48HDEWBL	48-port high density angled patch panel with enhanced labeling features and compatibility with Panduit hand-held printers. (Only accepts Mini-Com® Modules for UTP applications).	1	1	10
CPPA48HDVNSWBL	48-port high density angled patch panel with vertical numbering sequence from top to bottom across panel.	1	1	10

Mini-Com® High Density Modular Patch Panels				
CPP48HDWBL	48-port high density patch panel supplied with rear mounted faceplates (space not available for component labels).	1	1	10
CPP72FMWBL	72-port high density flush mount patch panel supplied with rear mounted faceplates.	2	1	10
CPP48HDEWBL	48-port high density patch panel with enhanced labeling features and compatibility with Panduit hand-held printers. (Only accepts Mini-Com® Modules for UTP applications).	1	1	10
CPP48HDVNSWBL	48-port high density patch panel with vertical numbering sequence from top to bottom across panel.	1	1	10

[^]One rack space = 1.75" (44.45mm).
M6 and #12-24 mounting screws included.

Component Labels for Mini-Com® High Density Modular Patch Panels



Suggested Label Solutions for TIA/EIA-606-A Compliance

Patch Panel Part Number	Laser/Ink Jet Desktop Printer Label	TDP43ME Thermal Transfer Desktop Printer Label	PanTher™ LS8E Hand-Held Printer Label	Cougar™ LS9 Hand-Held Printer Label
CPPA72FMWBL CPP72FMWBL CPPA48HDEWBL CPP48HDEWBL	C261X030FJJ	C261X030YPT	C261X030FJC	T031X000FJC-BK

48-port high density patch panel layout does not allow space for component labels.
For complete labeling solutions and product information, reference charts on pages O.1 – O.25.



Mini-Com® Modular Faceplate Patch Panels

- Release snap feature on faceplate allows front access to installed modules
- Accept Mini-Com® Modules for UTP, fiber optic, and audio/video, which snap in and out for easy moves, adds, and changes
- Label versions available for easy port identification; replacement label/label covers available

- Mount to standard EIA 19" racks or 23" racks with optional extender brackets
- Angled patch panels facilitate proper bend radius control and minimize the need for horizontal cable managers



CPPLA24WBLY

PATENTED



CPPLA48WBLY



CPPL24WBLY



CPPL48WBLY



CPP24WBLY



CPP48WBLY



C4PPLK

Part Number	Part Description	No. of Rack Spaces [^]	Std. Pkg. Qty.	Std. Ctn. Qty.
-------------	------------------	---------------------------------	----------------	----------------

Mini-Com® Angled Modular Patch Panels with Labels

CPPLA24WBLY	24-port angled patch panel with labels, supplied with six factory installed CFFPL4 type front removable snap-in faceplates.	1	1	10
CPPLA48WBLY	48-port angled patch panel with labels, supplied with twelve factory installed CFFPL4 type front removable snap-in faceplates.	2	1	10

Mini-Com® Modular Patch Panels with Labels

CPPL24WBLY	24-port patch panel with labels, supplied with six factory installed CFFPL4 type front removable snap-in faceplates.	1	1	10
CPPL48WBLY	48-port patch panel with labels, supplied with twelve factory installed CFFPL4 type front removable snap-in faceplates.	2	1	10

Mini-Com® Modular Patch Panels

CPP24WBLY	24-port patch panel supplied with six factory installed CFFP4 type front removable snap-in faceplates.	1	1	10
CPP48WBLY	48-port patch panel supplied with twelve factory installed CFFP4 type front removable snap-in faceplates.	2	1	10

Replacement Labels for Mini-Com® Modular Patch Panels

C4PPLK	Replacement label/label cover kit for Mini-Com® Modular Patch Panels with Labels (CPPL24WBLY, CPPL48WBLY, CPPL24WRBLY, CPPL48WRBLY) and Mini-Com® Modular Furniture Faceplates with Labels (CFFPL4, CFFHSL4, CFFPEBSL4). Each kit contains six labels and six clear label covers per bag.	—	1	10
---------------	---	---	---	----

[^]One rack space = 1.75" (44.45mm).
M6 and #12-24 mounting screws included.

Component Labels for Mini-Com® Modular Faceplate Patch Panels



Patch Panel Part Number	Suggested Label Solutions for TIA/EIA-606-A Compliance			
	Laser/Ink Jet Desktop Printer Label	TDP43ME Thermal Transfer Desktop Printer Label	PanTher™ LS8E Hand-Held Printer Label	Cougar™ LS9 Hand-Held Printer Label
All Patch Panels on this Page	C261X035Y1J	C261X035Y1T	C261X035Y1C	T038X000FJC-BK‡

For complete labeling solutions and product information, reference charts on pages O.1 – O.25.

‡For non-adhesive labeling solution, do not remove liner from label.



Mini-Com® M6 Style Modular Faceplate Patch Panels

- Arrange modules in groups of six (M6)
- Allow front access to installed modules
- Accept Mini-Com® Modules for UTP, fiber optic, and audio/video, which snap in and out for easy moves, adds, and changes
- Include pre-printed numbered labels with writable surface on back when pre-numbered labels are not applicable
- Mount to standard EIA 19" racks or 23" racks with optional extender brackets



CPPL24M6BLY



CPPL48M6BLY



C6PPLK1-24

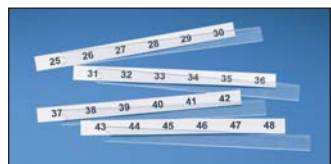

C6PPLK25-48

Part Number	Part Description	No. of Rack Spaces [^]	Std. Pkg. Qty.	Std. Ctn. Qty.
Mini-Com® M6 Style Modular Faceplate Patch Panels				
CPPL24M6BLY	24-port patch panel supplied with four factory installed CFPLM6BL snap-in faceplates.	1	1	10
CPPL48M6BLY	48-port patch panel supplied with eight factory installed CFPLM6BL snap-in faceplates.	2	1	10

Replacement Labels for Mini-Com® M6 Style Modular Faceplate Patch Panels

C6PPLK1-24	Replacement labels for Mini-Com® M6 Style Modular Faceplate Patch Panels with label/label covers (CPPL24M6BLY). Labels are pre-printed 1 – 24 on one side and write-on area on reverse side.	—	1	10
C6PPLK25-48	Replacement labels for Mini-Com® M6 Style Modular Faceplate Patch Panels with label/label covers (CPPL**M6BLY). Labels are pre-printed 25 – 48 on one side and write-on area on reverse side.	—	1	10

[^]One rack space = 1.75" (44.45mm).
M6 and #12-24 mounting screws included.

Component Labels for Mini-Com® M6 Style Modular Faceplate Patch Panels



Suggested Label Solutions for TIA/EIA-606-A Compliance

Patch Panel Part Number	Laser/Ink Jet Desktop Printer Label	TDP43ME Thermal Transfer Desktop Printer Label	PanTher™ LS8E Hand-Held Printer Label	Cougar™ LS9 Hand-Held Printer Label
CPPL24M6BLY CPPL48M6BLY	C390X030Y1J	C390X030Y1T	C390X030Y1C	T031X000FJC-BK‡

For complete labeling solutions and product information, reference charts on pages O.1 – O.25.

‡For non-adhesive labeling solution, do not remove liner from label.



Mini-Com® Recessed Modular Faceplate Patch Panels

- 3" recessed feature eliminates patch cord interference with cabinet doors and improves bend radius protection
- Release snap feature on faceplate allows front access to installed modules
- Accept Mini-Com® Modules for UTP, fiber optic, and audio/video, which snap in and out for easy moves, adds, and changes

- Labels included for easy port identification, replacement label/label covers available
- Mount to standard EIA 19" racks or 23" racks with optional extender brackets



CPPL24WRBLY



CPPL48WRBLY



C4PPLK

Part Number	Part Description	No. of Rack Spaces [^]	Std. Pkg. Qty.	Std. Ctn. Qty.
CPPL24WRBLY	24-port recessed patch panel with labels, supplied with six factory installed CFFPL4 type front removable snap-in faceplates. Designed for use with racks and cabinets.	1	1	10
CPPL48WRBLY	48-port recessed patch panel with labels, supplied with twelve factory installed CFFPL4 type front removable snap-in faceplates. Designed for use with racks and cabinets.	2	1	10
C4PPLK	Replacement label/label cover kit for Mini-Com® Modular Patch Panels with Labels (CPPL24WBLY, CPPL48WBLY, CPPL24WRBLY, CPPL48WRBLY) and Mini-Com® Modular Furniture Faceplates with Labels (CFFPL4, CFPHSL4, CFFPEBSL4). Each kit contains six labels and six clear label covers per bag.	—	1	10

[^]One rack space = 1.75" (44.45mm).
M6 and #12-24 mounting screws included.

Component Labels for Mini-Com® Recessed Modular Faceplate Patch Panels

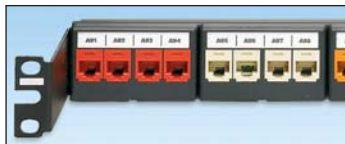

Patch Panel Part Number	Suggested Label Solutions for TIA/EIA-606-A Compliance			
	Laser/Ink Jet Desktop Printer Label	TDP43ME Thermal Transfer Desktop Printer Label	PanTher™ LS8E Hand-Held Printer Label	Cougar™ LS9 Hand-Held Printer Label
CPPL24WRBLY CPPL48WRBLY	C261X035Y1J	C261X035Y1T	C261X035Y1C	T038X000FJC-BK‡

For complete labeling solutions and product information, reference charts on pages O.1 – O.25.

‡For non-adhesive labeling solution, do not remove liner from label.



Mini-Com[®] 12-Port Modular Faceplate Patch Panels

- Release snap feature on faceplate allows simple front access for termination and accessibility to installed modules
- Mount directly onto wall
- Accept Mini-Com[®] Modules for UTP, fiber optic, and audio/video, which snap in and out for easy moves, adds, and changes
- Modular design for easy cabling revisions



CWPP12WBL



CPP12WBL



WB89D

Part Number	Part Description	Std. Pkg. Qty.	Std. Ctn. Qty.
CWPP12WBL	12-port patch panel supplied with three factory installed CFFP4 snap-in faceplates with integrated wall mount bracket.	1	10
CPP12WBL	12-port patch panel supplied with three factory installed CFFP4 snap-in faceplates. Mounts to standard 89D bracket (WB89D).	1	10
WB89D	Wall mount bracket accepts 12-port snap-in faceplate patch panel. Can also be used to mount industry standard 66 blocks.	1	10

Component Labels for Mini-Com[®] 12-Port Modular Faceplate Patch Panels



Suggested Label Solutions for TIA/EIA-606-A Compliance

Patch Panel Part Number	Laser/Ink Jet Desktop Printer Label	TDP43ME Thermal Transfer Desktop Printer Label	PanTher™ LS8E Hand-Held Printer Label	Cougar™ LS9 Hand-Held Printer Label
CWPP12WBL CPP12WBL	C261X030FJJ	C261X030YPT	C261X030FJC	T031X000FJC-BK

For complete labeling solutions and product information, reference charts on pages O.1 – O.25.



Mini-Com® All Metal Shielded Modular Patch Panels

- Accept Mini-Com® Modules for shielded applications
- Provide write-on areas for port identification
- Made of stainless steel
- CPT removal tool allows easy moves, adds, and changes of shielded jack modules
- Mount to standard TIA/EIA 19" rack or 23" racks with optional extender bracket



CP24BLY



CP48BLY



CP24WSBLY

PATENTED



CP48WSBLY



CPA24BLY



CPA48BLY

Part Number	Part Description	No. of Rack Spaces [^]	Std. Pkg. Qty.	Std. Ctn. Qty.
Mini-Com® All Metal Modular Patch Panels				
CP24BLY	24-port all metal modular patch panel.	1	1	10
CP48BLY	48-port all metal modular patch panel.	2	1	10
CP72BLY	72-port all metal modular patch panel. Rear cable management is required to prevent twisting.	2	1	10

Mini-Com® All Metal Modular Patch Panels with Strain Relief Bar

CP24WSBLY	24-port all metal modular patch panel with strain relief bar.	1	1	10
CP48WSBLY	48-port all metal modular patch panel with strain relief bar.	2	1	10

Mini-Com® All Metal Angled Modular Patch Panels

CPA24BLY	24-port angled all metal patch panel.	1	1	10
CPA48BLY	48-port angled all metal patch panel.	2	1	10
CPA72BLY	72-port angled all metal patch panel.	2	1	10

[^]One rack space = 1.75" (44.45mm).
M6 and #12-24 mounting screws included.
Each patch panel includes the CPT tool to ease removal of Mini-Com® Shielded Jack Modules.
Contact Customer Service for other available port options.
To bond the patch panel, see the patent pending StructuredGround™ Bonding Hardware Kits on page M.26.

Component Labels for Mini-Com® All Metal Shielded Modular Patch Panels

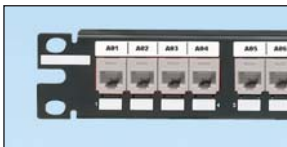

Suggested Labels Solutions for TIA/EIA-606-A Compliance				
Patch Panel Part Number	Laser/Ink Jet Desktop Printer Label	TDP43ME Thermal Transfer Desktop Printer Label	PanTher™ LS8E Hand-Held Printer Label	Cougar™ LS9 Hand-Held Printer Label
All Metal Shielded Modular Patch Panels on this page	C252X030FJJ	C252X030YPT	C252X030FJC	T031X000FJC-BK

For complete labeling solutions and product information, reference charts on pages O.1 – O.25.



Strain Relief Bar with Clips

- Mounts to the rear of standard EIA 19" racks behind each patch panel
- Supports 24 cables with hinged dual clips and provides bend radius protection

- Each adjustable clip can hold up to two cables; accommodates cable diameter range from 0.170" – 0.330" (4.3mm – 8.4mm)
- Provides superior aesthetics in cable management



PATENTED

Part Number	Part Description	No. of Rack Spaces [^]	Std. Pkg. Qty.	Std. Ctn. Qty.
SRBWCY	Strain relief bar with integrated adjustable clips; supports, manages, and provides bend radius protection for up to 24 cables in 1 RU.	1	1	10

[^]One rack space = 1.75" (44.45mm).



Strain Relief Bars for Patch Panels

- Mount to standard EIA 19" racks
- Ideal for standard density patch panels (24 ports per RU)

- Tak-Ty® Hook & Loop Cable Ties can be used for additional cable management



SRBM19BLY



SRBCT



SRB19BLY



SRB19D5BL



SRB19D7BL

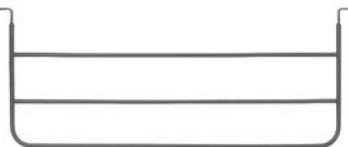

SRB19MDBL



SRBS19BL-XY



SRBBRKT

Part Number	Part Description	Std. Pkg. Qty.	Std. Ctn. Qty.
-------------	------------------	----------------	----------------

Strain Relief Bar/Manager

SRBM19BLY	Strain relief bar with six Tak-Ty® Hook & Loop Cable Ties; supports, manages, and provides proper bend radius protection for up to 72 cables.	1	10
SRBCT	Strain relief bar includes 24 cable ties to secure cable to each individual slot for additional stability; supports, manages, and provides proper bend radius protection.	1	10

Extended Strain Relief Bar

SRB19BLY	Strain relief bar extends 2" off the rack; supports, manages, and provides proper bend radius protection.	1	10
-----------------	---	---	----

Deep Strain Relief Bar

SRB19D5BL	Strain relief bar extends 5" off the rack; supports, manages, and provides proper bend radius protection.	1	10
SRB19D7BL	Strain relief bar extends 7" off the rack; supports, manages, and provides proper bend radius protection. Ideal for use with Category 6A copper cabling installations.	1	10
SRB19MDBL	Strain relief multi-depth bar extends 7" off the rack; supports, manages, and provides proper bend radius protection. Ideal for use with Category 6A copper cabling installations.	1	10

Straight Strain Relief Bar

SRBS19BL-XY	Strain relief bar; supports, manages, and provides proper bend radius protection.	10	—
--------------------	---	----	---

Strain Relief Bar Brackets

SRBBRKT	Quick release brackets for strain relief bars; convert conventional screw mounting to quick release mounting/removal.	1	10
----------------	---	---	----

#12-24 mounting screws included.

Cross Connect Punchdown System

- Exceeds all ANSI/TIA-568-C.2 Category 6 and 5e standard requirements for voice and data applications
- Third party tested
- Multiple mounting configurations allow brackets to be mounted to back board or wall maximizing the use of valuable space
- Integrated mounting notches are compatible with standard cross connect mounting brackets providing maximum design flexibility for new and existing Category 6 and Category 5e installations
- Mounting bases accept 4 and 5-pair connecting blocks up to 50 or 300-pairs
- 4 or 5-pair terminal markings on connecting blocks speed installation by assisting in punchdown terminal identification
- Punchdown tool terminates 22 – 26 AWG UTP cable
- Optional deep trough cable distribution ring maintains proper bend radius control providing improved cable management in 300 pair mounting systems for both horizontal and vertical cable routing
- Optional label kit compatible with 50 and 300-pair Panduit Cross Connect Bases; enables port identification enabling compliance according to ANSI/TIA/EIA-606-A labeling standards



PXMT50



PXMT300



PXPCB4



PXPCB5



PXDR

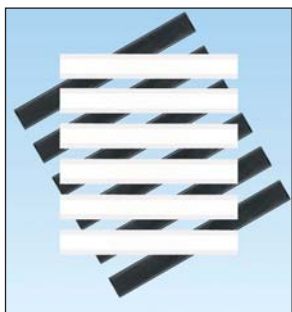

PXLK-VI

Part Number	Part Description	Std. Pkg. Qty.	Std. Ctn. Qty.
Mounting Bases			
PXMT50	50-pair mounting base.	1	0
PXMT300	300-pair mounting base.	1	0
Connecting Blocks			
PXPCB4	4-pair cross connect block.	1	20
PXPCB5	5-pair cross connect block.	1	20
Accessories			
PXDR	Cross connect cable distribution ring.	1	10
PXLK-VI	Cross connect label kit includes six labels and six label holders. Compatible with 50 and 300-pair cross connect bases.	6	60

For termination, use tool PDT110, found on page B.91, with blade 10665000 (available from Fluke).



GP6™ PLUS Category 6 High Density Kits

- Exceed ANSI/TIA-568-C.2 Category 6 standard
- Ideal for use in cross-connects and consolidation point applications
- Provides pre-packaged components necessary for termination

- Kit includes required quantity of bases and 4-pair connecting blocks, label holders and labels
- Highly visible color-coded wiring slots ease wiring



GPKBW144Y



GPKBW432Y

Part Number	Part Description	Std. Pkg. Qty.	Std. Ctn. Qty.
GPKBW144Y	144-pair (36-port) Category 6 high-density punchdown field termination kit with legs.	1	10
GPKBW432Y	432-pair (108-port) Category 6 high-density punchdown field termination kit with legs.	1	10

Cable requirement: terminates most 22-26 AWG solid or stranded IWC wire with a 0.050" (1.27mm) max o.d., either PVC or plenum rated.

Termination tool available on page B.83.

To ensure optimal performance, Panduit recommends use with other Panduit Category 6 PLUS components. Can be clearly identified with labels found on page B.80.



GP6™ PLUS Category 6 Standard Density Kits

- Exceed ANSI/TIA-568-C.2 Category 6 standard
- Ideal for use in cross-connects and consolidation point applications
- Provide pre-packaged components necessary for termination

- Kit includes required quantity of bases and 4-pair connecting blocks, label holders and labels
- Highly visible color-coded wiring slots ease wiring



GPKBW24Y



GPKBW72Y

Part Number	Part Description	Std. Pkg. Qty.	Std. Ctn. Qty.
GPKBW24Y	96-pair (24-port) Category 6 punchdown base field termination kit with legs.	1	10
GPKBW72Y	288-pair (72-port) Category 6 punchdown base field termination kit with legs.	1	10

Cable requirement: terminates most 22 – 26 AWG solid or stranded IWC wire with a 0.050" (1.27mm) max o.d., either PVC or plenum rated.

Termination tool available on page B.83.

To ensure optimal performance, Panduit recommends use with other Panduit Category 6 PLUS components. Can be clearly identified with labels found on page B.80.

GP6™ PLUS Category 6 High Density Rack Mount Panel Kits

- Exceed ANSI/TIA-568-C.2 Category 6 standard
- Ideal for use in cross-connects and consolidation point applications
- Provide pre-packaged components necessary for termination
- Include required quantity of bases and 4-pair connecting blocks, label holders, and labels
- Highly visible color-coded wiring slots ease wiring
- Mount to standard TIA/EIA 19" racks



GPB2884R2Y



GPB2884R4WJY

Part Number	Part Description	No. of Rack Spaces [^]	Std. Pkg. Qty.	Std. Ctn. Qty.
GPB2884R2Y	Two 144-pair (36-port) Category 6 punchdown bases pre-mounted to a panel with 4-pair connector kit included.	2	1	10
GPB2884R4WJY	Two 144-pair (36-port) Category 6 punchdown bases and jumper troughs pre-mounted to a panel with 4-pair connector kit included.	4	1	10

[^]One rack space = 1.75" (44.45mm).
M6 and #12-24 mounting screws included.
Termination tool available on page B.83.
Cable requirement: terminates most 22 – 26 AWG solid or stranded IWC wire with a 0.050" (1.27mm) max o.d., either PVC or plenum rated.
To ensure optimal performance, Panduit recommends use with other Panduit Category 6 PLUS components.
Can be clearly identified with labels found on page B.80.



GP6™ PLUS Category 6 Standard Density Rack Mount Panel Kits

- Exceed ANSI/TIA-568-C.2 Category 6 standard
- Ideal for use in cross-connects and consolidation point applications
- Provide pre-packaged components necessary for termination
- Include required quantity of bases and 4-pair connecting blocks, label holders, and labels
- Highly visible color-coded wiring slots ease wiring
- Mount to standard TIA/EIA 19" racks



GPB484R2Y



GPB484R4WJY

Part Number	Part Description	No. of Rack Spaces [^]	Std. Pkg. Qty.	Std. Ctn. Qty.
GPB484R2Y	Two 96-pair (24-port) Category 6 punchdown bases pre-mounted to panel with 4-pair connector kit included.	2	1	10
GPB484R4WJY	Two 96-pair (24-port) Category 6 punchdown bases and jumper troughs pre-mounted to panel with 4-pair connector kit included.	4	1	10

[^]One rack space = 1.75" (44.45mm).
M6 and #12-24 mounting screws included.
Termination tool available on page B.83.
Cable requirement: terminates most 22 – 26 AWG solid or stranded IWC wire with a 0.050" (1.27mm) max o.d., either PVC or plenum rated.
To ensure optimal performance, Panduit recommends use with other Panduit Category 6 PLUS components.
Can be clearly identified with labels found on page B.80.



GP6™ PLUS Category 6 Connecting Blocks

- Exceed ANSI/TIA-568-C.2 Category 6 standard
- Available in 4 or 5-pair connection blocks
- Highly visible color-coded wiring slots ease wiring
- Can be terminated with single or multiple position punchdown tools
- Can be utilized with discrete wires or GP6™ PLUS Patch Cord Connector
- Constructed of UL 94V-0 high impact polycarbonate material
- Patented single piece robust construction
- Optional 4-pair retaining clip (GPRC4) provides additional conductor retention and minimizes errors during moves, adds, and changes



GPCB4-*Y



GPCB5-*Y

Part Number	Part Description	Std. Pkg. Qty.	Std. Ctn. Qty.
4-Pair Connecting Block			
GPCB4-XY	4-pair Category 6 punchdown connecting block.	10	1000
GPCB4-CY	4-pair Category 6 punchdown connecting block.	100	1000
5-Pair Connecting Block			
GPCB5-XY	5-pair Category 6 punchdown connecting block.	10	1000
GPCB5-CY	5-pair Category 6 punchdown connection block.	100	1000

Termination tool available on page B.83.

Cable requirement: terminates most 22 – 26 AWG solid or stranded IWC wire with a 0.050" (1.27mm) max o.d., either PVC or plenum rated.

To ensure optimal performance, Panduit recommends use with other Panduit Category 6 PLUS components.



GP6™ PLUS Category 6 High Density Bases

- Exceed ANSI/TIA-568-C.2 Category 6 standard
- Ideal for use in cross-connects and consolidation point applications
- Highly visible color-coded wiring slots eases wiring
- Sturdy one-piece design
- Available with or without mounting legs for a variety of mounting options
- Multiple mounting holes available



GPB144-X

GPBW144-X

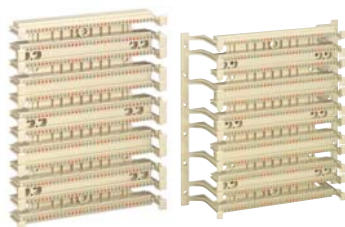

GPB432-X

GPBW432-X

Part Number	Part Description	Std. Pkg. Qty.
144-Pair (36-Port) Base		
GPB144-X	Positions and holds UTP wire for termination with Category 6 punchdown connecting blocks.	10
144-Pair (36-Port) Base – with Legs		
GPBW144-X	Positions and holds UTP wire for termination with Category 6 punchdown connecting blocks, includes mounting legs.	10
432-Pair (108-Port) Base		
GPB432-X	Positions and holds UTP wire for termination with Category 6 punchdown connecting blocks.	10
432-Pair (108-Port) Base – with Legs		
GPBW432-X	Positions and holds UTP wire for termination with Category 6 punchdown connecting blocks, includes mounting legs.	10

Termination tool available on page B.83.

For rack mount applications see page B.85

Cable requirement: terminates most 22 – 26 AWG solid or stranded IWC wire with a 0.050" (1.27mm) max o.d., either PVC or plenum rated.

To ensure optimal performance, Panduit recommends use with other Panduit Category 6 PLUS components.

Can be clearly identified with label holders and recommended labels shown on page B.80.



GP6™ PLUS Category 6 Standard Density Bases

- Exceed ANSI/TIA-568-C.2 Category 6 standard
- Ideal for use in cross-connects and consolidation point applications
- Highly visible color-coded wiring slots ease wiring
- Sturdy one-piece design
- Available with or without mounting legs for a variety of mounting options
- Multiple mounting holes available



GPB24-X

GPBW24-X



GPB72-X

GPBW72-X

Part Number	Part Description	Std. Pkg. Qty.
96-Pair (24-Port) Category 6 Punchdown Base		
GPB24-X	Positions and holds UTP wire for termination with Category 6 connecting blocks.	10
96-Pair (24-Port) Category 6 Punchdown Base – with Legs		
GPBW24-X	Positions and holds UTP wire for termination with Category 6 connecting blocks, includes mounting legs.	10
288-Pair (72-Port) Category 6 Punchdown Base		
GPB72-X	Positions and holds UTP wire for termination with Category 6 connecting blocks.	10
288-Pair (72-Port) Category 6 Punchdown Base – with Legs		
GPBW72-X	Positions and holds UTP wire for termination with Category 6 connecting blocks, includes mounting legs.	10

Termination tool available on page B.83.

For rack mount applications see page B.85.

Cable requirement: terminates most 22 – 26 AWG solid or stranded IWC wire with a 0.050" (1.27mm) max o.d., either PVC or plenum rated.

To ensure optimal performance, Panduit recommends use with other Panduit Category 6 components.

Can be clearly identified with label holders and recommended labels on page B.80.

GP6™ PLUS Standard Density Tower Kit

- Ideal for use in cross-connects, consolidation point, and wall mount applications
- Tower provides vertical feeder cable management
- Supplied with tower, bases, 4-pair connecting blocks, label and label holders



Part Number	Part Description	Std. Pkg. Qty.
GPKT724Y	288-pair (72-port) Category 6 punchdown standard density GP6™ PLUS Tower Kit.	1

Termination tool available on page B.83.

Cable requirement: terminates most 22 – 26 AWG solid or stranded IWC wire with a 0.050" (1.27mm) max o.d., either PVC or plenum rated.

To ensure optimal performance, Panduit recommends use with other Panduit Category 6 components.

Component Labels for GP6™ PLUS Category 6 Standard Density Bases and GP6™ PLUS Standard Density Tower Kit

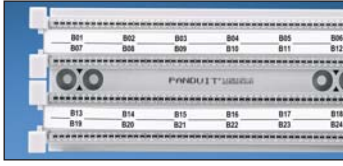

Suggested Label Solutions for TIA/EIA-606-A Compliance

Punchdown System Part Number	Laser/Ink Jet Desktop Printer Label	TDP43ME Thermal Transfer Desktop Printer Label	PanTher™ LS8E Hand-Held Printer Label	Cougar™ LS9 Hand-Held Printer Label
All GP Kits on pages C1.33 – C1.36	C788X050Y1J	C788X050Y1T	C788X050Y1C	T100X000VPC-BK‡

For complete labeling solutions and product information, reference charts on pages O.1 – O.25.

‡For non-adhesive labeling solution, do not remove liner from label.

UL LISTED SF CERTIFIED GP6™ PLUS Patch Connectors

- Patch into GP6™ PLUS Connecting Blocks
- Field terminable
- Cable clamp on cover facilitates easier wiring
- IDCs provide reliable, gas-tight connections
- Strain relief reduces stress on cable
- Contain two-piece, snap-together housing
- Polarized to prevent reverse installation to connector block
- Clear polycarbonate cover keeps conductors visible after termination
- Cover also provides proper wiring sequence



GPC5E1-XY



GPC5E2-XY

Part Number	Part Description	Std. Pkg. Qty.	Std. Ctn. Qty.
GPC5E1-XY	Terminates 1-pair 24 AWG solid or stranded cable.	10	100
GPC5E2-XY	Terminates 2-pair 24 AWG solid or stranded cable.	10	100

To ensure optimal performance, Panduit recommends use with other Panduit Category 6 components.



GP6™ PLUS Patch Cord Assemblies

- Exceed ANSI/TIA-568-C.2 Category 6 standard
- Factory assembled patch cord assembly

- Ideal for use in cross-connects and consolidation point applications with GP6™ PLUS Connector Blocks



GP6™ PLUS Patch Cord Assembly



GP6™ PLUS Patch Cord Assembly with RJ45 Connector

Part Number	Part Description	Length (Ft.)	Std. Pkg. Qty.	Std. Ctn. Qty.
GPPC4IG3Y	One 4-pair GP6™ PLUS Connector on each end.	3	1	10
GPPC4IG5Y		5	1	10
GPPC4IG7Y		7	1	10
GPPC4IG9Y		9	1	10
GPPC4IG14Y		14	1	10
GPPC4IG20Y		20	1	10
GPPC4IG3AY	One 4-pair GP6™ PLUS Connector wired to a RJ45 Pan-Plug® T568A wiring scheme.	3	1	10
GPPC4IG5AY		5	1	10
GPPC4IG7AY		7	1	10
GPPC4IG9AY		9	1	10
GPPC4IG14AY		14	1	10
GPPC4IG20AY		20	1	10
GPPC4IG3BY	One 4-pair GP6™ PLUS Connector wired to a RJ45 Pan-Plug® T568B wiring scheme.	3	1	10
GPPC4IG5BY		5	1	10
GPPC4IG7BY		7	1	10
GPPC4IG9BY		9	1	10
GPPC4IG14BY		14	1	10
GPPC4IG20BY		20	1	10

To ensure optimal performance, Panduit recommends use with other Panduit TX6™ PLUS components.

Cable Labels for GP6™ PLUS Patch Cord Assemblies



Suggested Label Solutions for TIA/EIA-606-A Compliance				
Patch Cord Part Number	Laser/Ink Jet Desktop Printer Label	TDP43ME Thermal Transfer Desktop Printer Label	PanTher™ LS8E Hand-Held Printer Label	Cougar™ LS9 Hand-Held Printer Label
All GPPC4IG Parts	S100X125YAJ	S100X125VATY	S100X125VAC	T100X000CBC-BK

For complete labeling solutions and product information, reference charts on pages O.1 – O.25.



GP6™ 1 and 2-Pair Patch Cord Assemblies

- Factory assembled patch cord assembly
- Ideal for use in cross-connect applications with GP6™ PLUS Connector Blocks



GPPC1IG*Y



GPPC2IG*Y

Part Number	Part Description	Length (Ft.)	Std. Pkg. Qty.	Std. Ctn. Qty.
GPPC1IG3Y	One 1-pair GP6™ Connector on each end.	3	1	10
GPPC1IG5Y		5	1	10
GPPC1IG7Y		7	1	10
GPPC1IG9Y		9	1	10
GPPC1IG14Y		14	1	10
GPPC1IG20Y		20	1	10
GPPC2IG3Y	One 2-pair GP6™ Connector on each end.	3	1	10
GPPC2IG5Y		5	1	10
GPPC2IG7Y		7	1	10
GPPC2IG9Y		9	1	10
GPPC2IG14Y		14	1	10
GPPC2IG20Y		20	1	10

LCable Labels for GP6™ 1 and 2-Pair Patch Cord Assemblies



Suggested Label Solutions for TIA/EIA-606-A Compliance

Patch Cord Part Number	Laser/Ink Jet Desktop Printer Label	TDP43ME Thermal Transfer Desktop Printer Label	PanTher™ LS8E Hand-Held Printer Label	Cougar™ LS9 Hand-Held Printer Label
All GPPC Parts	S100X125YAJ	S100X125VATY	S100X125VAC	T100X000CBC-BK

For complete labeling solutions and product information, reference charts on pages O.1 – O.25.



Jumper Troughs

- Available with or without legs for a variety of mounting options
- Unique finger design maintains cable bend radius
- Provide optimum cable management when used with GP6™ PLUS and Pan-Punch® Bases



Part Number	Part Description	Std. Pkg. Qty.
P110JTW-X	Jumper trough with legs.	10
P110JT-X	Jumper trough.	10
P110JTR2Y	Two jumper troughs mounted to two rack space panel.	1

GP6™ PLUS Termination Tools and Accessories

- Terminate wires on both cable and cross-connect sides of GP6™ Blocks
- Reversible blade provides option of terminating without cutting wire
- 4-pair punchdown tool seats 4 or 5-pair connecting blocks



GPDTM



GPST

Part Number	Part Description	Std. Pkg. Qty.	Std. Ctn. Qty.
4-Pair Punchdown Tool			
GPDTM	Inserts and cuts off up to 4-pairs at a time, for use with GP6™ PLUS System only.	1	10
4-Pair Replacement Head Assembly			
GPDTMH	Replacement head assembly for GP6™ PLUS 4-Pair Punchdown Tool.	1	10
4-Pair Replacement Blade			
GPDTMB	Replacement blade for GP6™ PLUS 4-Pair Punchdown Tool.	1	10
Single Wire Punchdown Tool			
GPST	Inserts and cuts off one wire at a time, for use with GP6™ PLUS System only.	1	—
Single Wire Replacement Blade			
GPSTB	Replacement blade for GP6™ PLUS Single Wire Punchdown Tool.	1	—



Pan-Punch® 110 Category 5e System Kits

- Exceed ANSI/TIA-568-C.2 Category 5e standard
- Field terminable
- Ideal for use in cross-connects and consolidation point applications
- Provide pre-packaged components necessary for termination

- Include required quantity of bases and connecting blocks, label holders and labels
- Available in 100 or 300-pair bases with 3, 4, or 5-pair connecting blocks



Part Number	Part Description	Std. Pkg. Qty.	Std. Ctn. Qty.
-------------	------------------	----------------	----------------

100-Pair Termination Kits

P110KB1004Y	Field terminated. Includes a base, 4-pair connector kit with five 4-pair connectors and one 5-pair connector per row of 25 pairs, two label holders, and two white designation labels.	1	10
P110KB1005Y	Field terminated. Includes a base, 5-pair connector kit with five 5-pair connectors per row of 25 pairs, two label holders, and two white designation labels.	1	10

300-Pair Termination Kits

P110KB3004Y	Field terminated. Includes a base, 4-pair connector kit with five 4-pair connectors and one 5-pair connector per row of 25 pairs, six label holders, and six white designation labels.	1	10
P110KB3005Y	Field terminated. Includes a base, 5-pair connector kit with five 5-pair connectors per row of 25 pairs, six label holders, and six white designation labels.	1	10

It is common practice to completely fill each 25-pair wire strip with connecting blocks. Each kit contains the adequate number of connecting blocks to do so. Example: P110KB1004 includes five 4-pair and one 5-pair connecting block per 25-pair wiring strip for a total of twenty 4-pair and four 5-pair connecting blocks as well as two label holders and two white designation labels.

Termination tool available on page B.91.

Cable requirement: terminates most 22 – 26 AWG solid or stranded IWC wire with a 0.050" (1.27mm) max o.d., either PVC or plenum rated.

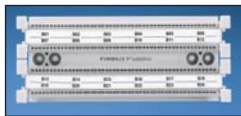

Component Quantity per Pan-Punch® 110 Category 5e Kits

Part Number	Bases		Connecting Blocks			Label Holders	Labels
	P110BW300	P110BW100	P110CB3	P110CB4	P110CB5	P110LH	DSL110
P110KB1004Y	—	1	—	20	4	2	2
P110KB1005Y	—	1	—	—	20	2	2
P110KB3004Y	1	—	—	60	12	6	6
P110KB3005Y	1	—	—	—	60	6	6

19" Punchdown Rack Mount Panels

- Accept punchdown bases for rack mount applications



P110B100R2BY



P110B100R4BY

Part Number	Part Description	No. of Rack Spaces [^]	Std. Pkg. Qty.	Std. Ctn. Qty.
P110B100R2BY	Panel accepts up to 2 RU of punchdown bases.	2	1	10
P110B100R4BY	Panel accepts up to 4 RU of punchdown bases.	4	1	10

[^]One rack space = 1.75" (44.45mm).
Includes mounting screws.

Pan-Punch® Category 5e 19" Rack Mount Panels

- Exceed ANSI/TIA-568-C.2 Category 5e standard
- Ideal for use in cross-connects and consolidation point applications
- Mount to standard TIA/EIA 19" racks
- Exclusive deeper channel to facilitate TIA/EIA Category 5e cabling installations



P110B100R2Y

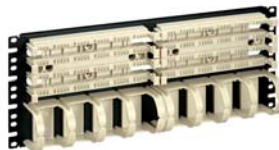

P110B100R4WJY

Part Number	Part Description	No. of Rack Spaces [^]	Std. Pkg. Qty.	Std. Ctn. Qty.
P110B100R2Y	Two 100-pair bases premounted to panel.	2	1	10
P110B100R4WJY	Two 100-pair bases with jumper troughs premounted to panel.	4	1	10

[^]One rack space = 1.75" (44.45mm).
Includes mounting screws.
Termination tool available on page B.91.
For connecting blocks see page B.88.
Can be clearly identified with label holders and recommended labels shown on page B.84.

Pan-Punch® Category 5e 19" Rack Mount Panel Kits

- Exceed ANSI/TIA-568-C.2 Category 5e standard
- Field terminable
- Ideal for use in cross-connects and consolidation point applications
- Include required quantity of bases and connecting blocks, label holders, and labels
- Available with 4 or 5-pair connecting blocks



P110B1004R2Y

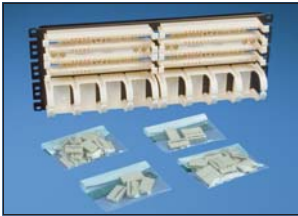

P110B1004R4WJY

Part Number	Part Description	No. of Rack Spaces [^]	Std. Pkg. Qty.	Std. Ctn. Qty.
-------------	------------------	---------------------------------	----------------	----------------

Rack Mount Panel Kit with Bases and Connecting Blocks

P110B1004R2Y	Two 100-pair bases premounted to panel. 4-pair connector kit included with five 4-pair connectors and one 5-pair connector per row of 25 pairs.	2	1	10
P110B1005R2Y	Two 100-pair bases premounted to panel. 5-pair connector kit included with five 5-pair connectors per row of 25 pairs.	2	1	10

Rack Mount Panel Kit with Bases, Connecting Blocks, and Jumper Troughs

P110B1004R4WJY	Two 100-pair bases and jumper troughs premounted to 19" rack mount panel. 4-pair connector kit included with five 4-pair connectors and one 5-pair connector per row of 25 pairs.	4	1	10
P110B1005R4WJY	Two 100-pair bases and jumper troughs premounted to 19" rack mount panel with 5-pair connector kit included with five 5-pair connectors per row of 25 pairs.	4	1	10

[^]One rack space = 1.75" (44.45mm).
Includes mounting screws.
Termination tool available on page B.91.
Can be clearly identified with labels found on page B.84.



Pan-Punch® 110 Category 5e Tower System

- Provides a complete cross-connect system
- Designed for wall mount applications
- Available in 300 and 900 pair configurations with 3, 4, or 5-pair connecting blocks
- Supplied jumper troughs provide horizontal cable management
- Tower provides vertical feeder cable management

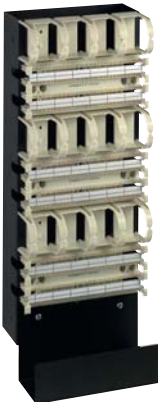

P110KT300Y

Part Number	Part Description	Std. Pkg. Qty.
-------------	------------------	----------------

Pan-Punch® 300-Pair Tower Kits

P110KT3004Y	Convenient packaging includes all of the components required to completely wire a 110 base.	1
P110KT3005Y		1

Pan-Punch® 900-Pair Tower Kits

P110KT9004Y	Convenient packaging includes all of the components required to completely wire a 110 base.	1
P110KT9005Y		1

Pan-Punch® Towers

P110T300Y	300-pair tower. Components sold separately.	1
P110T900Y	900-pair tower. Components sold separately.	1

Each tower system contains adequate connecting blocks to complete each 25-pair wiring strip. Example: P110KT3004Y includes five 4-pair and one 5-pair connecting block per 25-pair wiring strip for a total of sixty 4-pair and twelve 5-pair connecting blocks.

GP6™ PLUS system can be installed on individual towers, not recommended for use with GP6™ PLUS high density bases.

Termination tool available on page B.91.

Cable requirement: terminates most 22 – 26 AWG solid or stranded IWC wire with a 0.050" (1.27mm) max o.d., either PVC or plenum rated.

Component Labels for Pan-Punch® 110 Category 5e Tower Systems

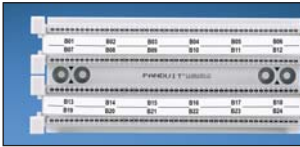

Suggested Label Solutions for TIA/EIA-606-A Compliance				
Punchdown System Part Number	Laser/Ink Desktop Printer Label	TDP43ME Thermal Transfer Desktop Printer Label	PanTher™ LS8E Hand-Held Printer Label	Cougar™ LS9 Hand-Held Printer Label
All Pan-Punch® Tower Kits	C750X050Y1J	C750X050Y1T	C750X050Y1C	T050X000VPC-BK‡

For complete labeling solutions and product information, reference charts on pages O.1 – O.25.

‡For non-adhesive labeling solution, do not remove liner from label.



Vertical Cable Managers for Tower Systems

- Finger design allows for easy changes
- Can be mounted between towers
- Compatible with GP6™ PLUS or 110 Tower Systems
- Designed for wall mount or 19" rack mount applications
- Facilitates vertical cable management
- Rugged all metal construction



Part Number	Part Description	Color	Std. Pkg. Qty.
Vertical Cable Manager for use with 300-Pair Tower System			
P110VCM300	Mounts adjacent to 300-pair tower system.	Black	1
Vertical Cable Manager for use with Backboard Mounting			
P110VCM	Mounts to plywood backboard and adjacent to bases and jumper troughs. White metal backboard and large D-rings, designed for wall mount vertical or horizontal cable management.	White	1
Vertical Cable Manager for use with 900-Pair Tower System			
P110VCM900	Mounts adjacent to 900-pair tower system.	Black	1

110 Punchdown Label Holder

- Use with adhesive or non-adhesive designation labels



Part Number	Part Description	Std. Pkg. Qty.	Std. Ctn. Qty.
P110LH	Label holder snaps into 110 and GP6™ Bases.	6	60

Component Labels for 110 Punchdown Designation Label Holders

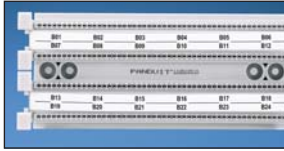

Suggested Label Solutions for TIA/EIA-606-A Compliance

Punchdown Holder Part Number	Laser/Ink Jet Desktop Printer Label	TDP43ME Thermal Transfer Desktop Printer Label	PanTher™ LS8E Hand-Held Printer Label	Cougar™ LS9 Hand-Held Printer Label
P110LH	C750X050Y1J	C750X050Y1T	C750X050Y1C	T050X000VPC-BK‡

For complete labeling solutions and product information, reference charts on pages O.1 – O.25.

‡For non-adhesive labeling solution, do not remove liner from label.



19" Rack Mount Bracket Kits

- Used to attach tower systems and vertical cable managers to 19" racks
- Use two towers side-by-side or a tower and a vertical wire manager side-by-side
- Include brackets and mounting screws



Part Number	Part Description	Std. Pkg. Qty.
P110TB300Y	Kit for 300-pair tower or vertical wire management.	1
P110TB900Y	Kit for 900-pair tower or vertical wire management.	1



Pan-Punch[®] 110 Category 5e Connecting Blocks

- Exceeds ANSI/TIA-568-C.2 Category 5e standard
- Available in 3, 4, or 5-pair connection blocks
- Dual IDC terminates UTP cable on 110 base and UTP cable or 110 patch cords for cross-connecting
- Highly visible color-coded wiring slots ease wiring
- Can be used with single or multiple punchdown tools
- Can be utilized with discrete wires or Pan-Punch[®] Patch Cord Connector
- Constructed of UL 94V-0 high impact polycarbonate material
- Patented single piece robust construction

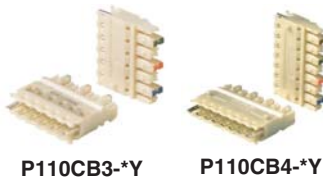

Part Number	Part Description	Std. Pkg. Qty.	Std. Ctn. Qty.
3-Pair 110 Connecting Blocks			
P110CB3-XY	3-pair connecting block.	10	1000
P110CB3-CY		100	1000
4-Pair 110 Connecting Blocks			
P110CB4-XY	4-pair connecting block.	10	1000
P110CB4-CY		100	1000
5-Pair 110 Connecting Blocks			
P110CB5-XY	5-pair connecting block.	10	1000
P110CB5-CY		100	1000

Termination tool available on page B.91.

Cable requirement: terminates most 22 – 26 AWG solid or stranded IWC wire with a 0.050" (1.27mm) max o.d., either PVC or plenum rated.



Pan-Punch® 110 Category 5e Bases

- Exclusive deeper channel to facilitate TIA/EIA-568-C.2 Category 5e cabling installations
- Ideal for use in cross-connects and consolidation point applications
- Available with or without legs for various mounting options
- Sturdy one-piece design
- Highly visible color-coded wiring strip



P110BW100-X P110BW300-X



P110B100-X P110B300-X

Part Number	Part Description	Std. Pkg. Qty.
100-Pair Base – with Legs		
P110BW100-X	Positions and holds UTP cable for termination with Pan-Punch® 110 Connecting Blocks. Legs allow cables to be routed behind bases.	10
100-Pair Base		
P110B100-X	Positions and holds UTP cable for termination with Pan-Punch® 110 Connecting Blocks. For frame or rack mount wiring behind bases.	10
300-Pair Base – with Legs		
P110BW300-X	Positions and holds UTP cable for termination with Pan-Punch® 110 Connecting Blocks. Legs allow cables to be routed behind bases.	10
300-Pair Base		
P110B300-X	Positions and holds UTP cable for termination with Pan-Punch® 110 Connecting Blocks. For frame or rack mount wiring behind bases.	10

Cable requirement: terminates most 22 – 26 AWG solid or stranded IWC wire with a 0.050" (1.27mm) max o.d., either PVC or plenum rated.
Can be clearly identified with label holders and recommended labels shown on page B.84.



Pan-Punch® 110 Patch Connectors

- Contain two-piece, snap together housing
- Field terminable
- Cable clamp on cover provides easier wiring
- IDCs provide reliable gas-tight connections
- Strain relief reduces stress on cable
- Polarized to prevent reverse installation to connector block
- Clear polycarbonate cover keeps conductors visible after termination



P110PC1-XY P110PC2-XY



P110PC3-XY P110PC4-XY

Part Number	Part Description	Std. Pkg. Qty.	Std. Ctn. Qty.
P110PC1-XY	Terminates 1-pair, 24 AWG solid or stranded cable.	10	100
P110PC2-XY	Terminates 2-pairs, 24 AWG solid or stranded cable.	10	100
P110PC3-XY	Terminates 3-pairs, 24 AWG solid or stranded cable.	10	100
P110PC4-XY	Terminates 4-pairs, 24 AWG solid or stranded cable.	10	100



Pan-Punch® 110 Patch Cord Assemblies

- Factory assembled patch cord assembly
- Ideal for use in cross-connect applications with Pan-Punch® 110 connecting blocks



P110PC*IG*Y



P110PC*IG*AY

Part Number	Part Description	Length (Ft.)‡	Std. Pkg. Qty.	Std. Ctn. Qty.
P110PC1IG2Y	1-pair 110 connector on each end. Meets Category 3 performance requirements.	2	1	10
P110PC1IG4Y		4	1	10
P110PC1IG5Y		5	1	10
P110PC1IG6Y		6	1	10
P110PC2IG2Y	2-pair 110 connector on each end. Meets Category 5 performance requirements.	2	1	10
P110PC2IG4Y		4	1	10
P110PC2IG5Y		5	1	10
P110PC2IG6Y		6	1	10
P110PC4IG2Y	4-pair 110 connector on each end. Meets Category 5e performance requirements.	2	1	10
P110PC4IG4Y		4	1	10
P110PC4IG5Y		5	1	10
P110PC4IG6Y		6	1	10
P110PC4IG2AY	4-pair 110 connector to Pan-Plug® RJ45 modular plug – T568A wired. Meets Category 5e performance requirements.	2	1	10
P110PC4IG4AY		4	1	10
P110PC4IG5AY		5	1	10
P110PC4IG6AY		6	1	10
P110PC4IG2BY	4-pair 110 connector to Pan-Plug® RJ45 modular plug – T568B wired. Meets Category 5e performance requirements.	2	1	10
P110PC4IG4BY		4	1	10
P110PC4IG5BY		5	1	10
P110PC4IG6BY		6	1	10

‡For lengths 7, 8, 9, 12, or 15 feet, change the length designation in the part number to the desired length.

Cable Labels for Pan-Punch® 110 Patch Cord Assemblies



Suggested Label Solutions for TIA/EIA-606-A Compliance

Patch Cord Assemblies Part Number	Laser/Ink Jet Desktop Printer Label	TDP43ME Thermal Transfer Desktop Printer Label	PanTher™ LS8E Hand-Held Printer Label	Cougar™ LS9 Hand-Held Printer Label
P110PC1	S100X125YAJ	S100X125VATY	S100X125VAC	T100X000CBC-BK
P110PC2&4	S100X150YAJ	S100X150VATY	S100X150VAC	T100X000CBC-BK

For complete labeling solutions and product information, reference charts on pages O.1 – O.25.



Jumper Troughs

- Available with or without legs for a variety of mounting options
- Unique finger design maintains cable bend radius

- Provide optimum cable management when used with GP6™ PLUS and Pan-Punch® Bases



P110JT-X

P110JTW-X

Part Number	Part Description	Std. Pkg. Qty.
P110JTW-X	Jumper trough with legs.	10
P110JT-X	Jumper trough.	10
P110JTR2Y	Two jumper troughs mounted to two rack space panel.	1

Pan-Punch® Punchdown Tools and Accessories

- Terminate wires on both cable and cross-connect sides of 110 connecting blocks
- Single pair punchdown tool terminates on the back of the DP6A™ 10Gig™, DP6™ PLUS, and DP5e™ Patch Panels

- Reversible blade provides option of terminating without cutting wire
- 5-pair punchdown tool seats 3, 4, or 5-pair connecting blocks onto 110 base



PDT110M



PDT110

Part Number	Part Description	Std. Pkg. Qty.	Std. Ctn. Qty.
5-Pair Punchdown Tool			
PDT110M	5-pair punchdown tool, can terminate up to 5 pairs at a time.	1	10
Replacement Head			
PDH110M	Replacement head assembly for 5-pair punchdown tool.	1	10
Replacement Blade Assembly			
PDB110M	Replacement blade for 5-pair punchdown tool.	1	10
Single Punchdown Tool			
PDT110	Punchdown tool and blade for 110 style IDCs. Terminates and cuts UTP cable in one operation.	1	—
Replacement Blade			
PDTH110	Replacement blade for single pair punchdown tool.	1	—



RJ45 Jack Blockout Device

- Blocks unauthorized access to jacks and potentially harmful foreign objects, saving time and money associated with data security breaches, network downtime, repair and hardware replacement
- Compatible with most RJ45 jacks to accommodate a variety of applications and does not interfere with jack contacts

- Can be installed/removed without interfering with adjacent jacks or hardware
- May only be released with the special removal tool, ensuring the safety and security of your network infrastructure

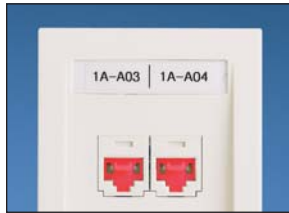
**PSL-DCJB**

Part Number	Part Description	Color	Std. Pkg. Qty.	Std. Ctn. Qty.
PSL-DCJB*	Package of ten RJ45 jack blockout devices and one removal tool.	Red	1	20
PSL-DCJB-BL*	Package of ten RJ45 jack blockout devices and one removal tool.	Black	1	20
PSL-DCJB-BU*	Package of ten RJ45 jack blockout devices and one removal tool.	Blue	1	20
PSL-DCJB-YL*	Package of ten RJ45 jack blockout devices and one removal tool.	Yellow	1	20
PSL-DCJB-IW*	Package of ten RJ45 jack blockout devices and one removal tool.	International White	1	20
PSL-DCJB-GR*	Package of ten RJ45 jack blockout devices and one removal tool.	Green	1	20
PSL-DCJB-OR*	Package of ten RJ45 jack blockout devices and one removal tool.	Orange	1	20
PSL-DCJB-IG*	Package of ten RJ45 jack blockout devices and one removal tool.	International Gray	1	20
PSL-DCJB-VL*	Package of ten RJ45 jack blockout devices and one removal tool.	Violet	1	20

*Available in bulk packages of 100 devices and five removal tools. To order bulk package add -C to the suffix of part number.

USB Blockout Device



- Blockout devices block unauthorized access to USB ports, to provide additional security from viruses being loaded and illicit data being removed through the USB port
- Type A blockouts compatible with USB 2.0 and USB 3.0 Type “A” ports; Type B blockouts compatible with USB 2.0 Type “B” ports
- Can be installed without interfering with adjacent USB ports
- May only be released with the special removal tool, ensuring the safety and security of your network infrastructure; Permanent blockouts are not releasable



PSL-DCJBUSBA



PSL-DCJBPERM-USBA



PSL-DCJBUSBB



PSL-DCJBPERM-USBB

Part Number	Part Description	Color	Std. Pkg. Qty.	Std. Ctn. Qty.
USB Type A Blockouts				
PSL-USBA*	Package of five USB Type ‘A’ blockout devices and one removal tool.	Red	1	20
PSL-PERM-USBA	Package of ten Permanent USB Type ‘A’ blockout devices.	Red	1	20
USB Type B Blockouts				
PSL-USBB	Package of ten USB Type ‘B’ blockout devices and one removal tool.	Red	1	20
PSL-PERM-USBB	Package of ten Permanent USB Type ‘B’ blockout devices.	Red	1	20

*Available in bulk packages of 50 devices and five removal tools. To order bulk package add -L to the suffix of part number.



RJ45 Plug Lock-In Device

- Tamper-resistant design blocks unauthorized removal of cable, VoIP phone, other networking equipment, or critical connection
- Compatible with UTP and shielded Category 6A, 6, and UTP Category 5e patch cords
- Deters unauthorized users from moving or stealing VoIP phones helping to maintain E911 service

- Compact design does not interfere with adjacent jack modules, even in high-density applications
- Installation/removal tool allows plug to be locked into or released from jack module for enhanced physical security
- Locking mechanism is white for flush mount and clear for recessed devices



PPSL-DCPLRX-BL



Part Number	Part Description	Color	Std. Pkg. Qty.	Std. Ctn. Qty.
Flush – Compatible With Flush Mounted Jack Modules				
PSL-DCPLX*	Package of ten RJ45 plug lock-in devices and one installation/removal tool.	Red	1	20
PSL-DCPLX-BL*	Package of ten RJ45 plug lock-in devices and one installation/removal tool.	Black	1	20
PSL-DCPLX-BU*	Package of ten RJ45 plug lock-in devices and one installation/removal tool.	Blue	1	20
PSL-DCPLX-YL*	Package of ten RJ45 plug lock-in devices and one installation/removal tool.	Yellow	1	20
PSL-DCPLX-IW*	Package of ten RJ45 plug lock-in devices and one installation/removal tool.	International White	1	20
PSL-DCPLX-GR*	Package of ten RJ45 plug lock-in devices and one installation/removal tool.	Green	1	20
PSL-DCPLX-OR*	Package of ten RJ45 plug lock-in devices and one installation/removal tool.	Orange	1	20
PSL-DCPLX-IG*	Package of ten RJ45 plug lock-in devices and one installation/removal tool.	International Gray	1	20
PSL-DCPLX-VL*	Package of ten RJ45 plug lock-in devices and one installation/removal tool.	Violet	1	20

Recessed – Compatible With Recessed Jack Modules

PSL-DCPLRX*	Package of ten recessed RJ45 plug lock-in devices and one installation/removal tool.	Red	1	20
PSL-DCPLRX-BL*	Package of ten recessed RJ45 plug lock-in devices and one installation/removal tool.	Black	1	20
PSL-DCPLRX-BU*	Package of ten recessed RJ45 plug lock-in devices and one installation/removal tool.	Blue	1	20
PSL-DCPLRX-YL*	Package of ten recessed RJ45 plug lock-in devices and one installation/removal tool.	Yellow	1	20
PSL-DCPLRX-IW*	Package of ten recessed RJ45 plug lock-in devices and one installation/removal tool.	International White	1	20
PSL-DCPLRX-GR*	Package of ten recessed RJ45 plug lock-in devices and one installation/removal tool.	Green	1	20
PSL-DCPLRX-OR*	Package of ten recessed RJ45 plug lock-in devices and one installation/removal tool.	Orange	1	20
PSL-DCPLRX-IG*	Package of ten recessed RJ45 plug lock-in devices and one installation/removal tool.	International Gray	1	20
PSL-DCPLRX-VL*	Package of ten recessed RJ45 plug lock-in devices and one installation/removal tool.	Violet	1	20

*Available in bulk packages of 100 devices and five installation/removal tools. To order bulk package add -C to the suffix of part number. The RJ45 plug lock-in device may not be compatible with all jacks, overmolded cables, or PanView™ Cables.

Self-Laminating Cable Marker Holders for Large Cables or Cable Bundles

- Durable tag to mark a wide range of cables and cable bundles
- Can be used with printer generated labels or hand-written
- Attaches easily with Panduit intermediate or standard cross-section nylon cable ties or Panduit® Tak-Ty® Hook & Loop Cable Ties
- Clear overlamine protects legend
- Can be applied as a wrap-around marker (parallel to cable) or flag marker (45° or 90° to cable)
- Available in white, yellow, orange, and gray
- Large label area provides ample room for complex labeling scheme



SLCT-WH



SLCT-OR

Part Number	Part Description	Width		Height		Std. Pkg. Qty.	Std. Ctn. Qty.
		In.	mm	In.	mm		
SLCT-WH	White, self-laminating cable marker holder, 25 tags/pkg.	3.00	76.2	1.31	33.3	1	4
SLCT-OR	Orange, self-laminating cable marker holder, 25 tags/pkg.	3.00	76.2	1.31	33.3	1	4
SLCT-YL	Yellow, self-laminating cable marker holder, 25 tags/pkg.	3.00	76.2	1.31	33.3	1	4
SLCT-IG	Gray, self-laminating cable marker holder, 25 tags/pkg.	3.00	76.2	1.31	33.3	1	4

Attach with Panduit Intermediate or Standard cross section cable ties.

Component Labels for Self-Laminating Cable Markers or Large Cables or Cable Bundles



Suggested Label Solutions for TIA/EIA-606-A Compliance				
Cable Marker Holder Part Number	Laser/Ink Jet Desktop Printer Label	TDP43ME Thermal Transfer Desktop Printer Label	PanTher™ LS8E Hand-Held Printer Label	Cougar™ LS9 Hand-Held Printer Label
All SLCT Parts	C200X100FJJ	C200X100YPT	C200X100FJC	T100X000VPC-BK

For complete labeling solutions and product information, reference charts on pages O.1 – O.25.

Thermal Transfer Marker Plates

- Non-adhesive marker plates offer crisp, clear legends with superior legibility
- Attachable in a horizontal or vertical orientation

- Available in a variety of colors and sizes
- Use with Panduit RMR4BL resin thermal transfer ribbon



Part Number	Part Description	Width		Height		Print-On Area Width		Labels Per Roll	Std. Pkg. Qty.	Std. Ctn. Qty.
		In.	mm	In.	mm	In.	mm			
M300X100Y6T	Yellow, thermal transfer marker plate.	3.00	76.2	1.00	25.4	1.80	45.7	500	1	4
M300X100Y7T	White, thermal transfer marker plate.	3.00	76.2	1.00	25.4	1.80	45.7	500	1	4
M300X050Y6T	Yellow, thermal transfer marker plate.	3.00	76.2	0.50	12.7	2.07	52.6	500	1	4
M300X050Y7T	White, thermal transfer marker plate.	3.00	76.2	0.50	12.7	2.07	52.6	500	1	4
M200X100Y6T	Yellow, thermal transfer marker plate.	2.00	50.8	1.00	25.4	0.80	20.3	500	1	4
M200X100Y7T	White, thermal transfer marker plate.	2.00	50.8	1.00	25.4	0.80	20.3	500	1	4
M200X050Y6T	Yellow, thermal transfer marker plate.	2.00	50.8	0.50	12.7	1.07	27.3	500	1	4
M200X050Y7T	White, thermal transfer marker plate.	2.00	50.8	0.50	12.7	1.07	27.3	500	1	4

Patch Cord Color Bands

- Removable band snaps on and off individual cables allowing the same patch cord to be used for different applications
- Can be installed next to each other allowing multiple color bands to be used on one cable, offering endless color coding options
- Internal grooves secure color bands in place on cable providing easy identification at the connection
- Available in 10 standard colors that match Panduit connectivity providing an aesthetically pleasing solution
- Compatible with all Panduit patch cords, existing and new installations can be color-coded as networks change



Part Number	Part Description	Color	Std. Pkg. Qty.
PCBANDBL-Q	Snaps onto individual patch cable for additional color-coding.	Black	25
PCBANDBU-Q		Blue	25
PCBANDWH-Q		White	25
PCBANDEI-Q		Electric Ivory	25
PCBANDIG-Q		International Gray	25
PCBANDOR-Q		Orange	25
PCBANDRD-Q		Red	25
PCBANDGR-Q		Green	25
PCBANDYL-Q		Yellow	25
PCBANDVL-Q		Violet	25

Patch cords available on pages B.18, B.25, B.34, B.46, B.50.

Cable Prep Tools

- Copper Wire Snipping Tool (CWST) cuts conductors flush for improved performance
- Adjustable Cable Jacket Stripping Tool (CJAST) strips outer jacket of 4-pair UTP and shielded copper cable



CWST



CJAST

Part Number	Part Description	Std. Pkg. Qty.
CWST	Copper conductor snipping tool.	1
CJAST	Cable jacket stripping tool.	1
CJASTB	Replacement blade for cable stripping tool CJAST.	1

Module Termination Tools and Accessories

- TGJT termination tool easily terminates all TG style jack modules, reducing installation time by 25%
- EGJT tool assists in terminating all enhanced Giga-TX™ Style Jack Modules by ensuring conductors are fully terminated by utilizing smooth forward motion without impact on critical internal components for maximum reliability
- CGJT termination tool terminates all Mini-Com® Mini-Jack™ Jack Modules
- CJT-X tool assists in terminating all Mini-Com® Mini-Jack™ Jack Modules by ensuring conductors are fully terminated
- Punchdown base (AVPDB) available for terminating S-video and RCA punchdown modules
- Dust cap keeps out dust and debris from RJ45 style jack modules while not in use



TGJT



EGJT



CGJT



CJT-X



AVPDB



MDC-C

Part Number	Part Description	Std. Pkg. Qty.	Std. Ctn. Qty.
TGJT	TG termination tool easily terminates all TG style jack modules by cutting conductors flush and assembling wire cap and jack. Ideal for high volume installations.	1	—
EGJT	Terminates enhanced Giga-TX™ TG Style Jack Modules.	1	50
CGJT	Terminates Giga-TX™ TP Style Jack Modules.	1	50
CJT-X	Terminates Mini-Com® Mini-Jack™ Jack Modules.	10	50
AVPDB	Audio/video punchdown base used to assist in terminating Mini-Com® S-Video and RCA Punchdown Modules.	1	50
MDC-C	Jack module dust cap. Compatible with all RJ45 Mini-Com® Jack Modules.	100	1000

Patch cord and connector removal tools for high-density applications are available on page B.98.

Patch Cord Removal Tool

- Tool arms allow the installer to pass over cabling which interferes with accessibility
- Compatible with copper and fiber patch cords
- Optional flashlight kit (KPCRT1-FL) attaches to top of tool



PCRT1



KPCRT1-FL

Part Number	Part Description	Std. Pkg. Qty.
PCRT1	Easily removes copper and fiber patch cords in dense rack installations.	1
KPCRT1-FL	Flashlight kit for patch cord removal tool (PCRT1).	1

Modular Plug Termination Tools

- WPT-8 arranges all eight conductors in the proper sequence and provides proper gauge length for trimming conductors for MP588
- MPT5-8AS required for modular plug termination



WPT-8



MPT5-8AS

Part Number	Part Description	Std. Pkg. Qty.	Std. Ctn. Qty.
Wire Prep Tool			
WPT-8	Crimp tool for TX6™ PLUS and Pan-Plug™ Modular Plugs.	1	10
Modular Plug Installation Tool			
MPT5-8AS	Crimp tool for TX6™ PLUS and Pan-Plug® Modular Plugs.	1	—

FIBER OPTIC SYSTEMS

Panduit provides high bandwidth and mission critical physical infrastructures in data center, enterprise, and campus networks with comprehensive fiber optic systems that deliver high performance, reliability and scalability. By leveraging its technology leadership, innovative design and cable management expertise, Panduit fiber optic systems meet today's requirements and provide a migration path for tomorrow's applications. These systems accommodate multiple termination options, including pre-terminated, field-terminated, and field-spliced methods, to meet your specific cabling infrastructure requirements. Panduit fiber optic systems offer the industry's highest patch field density combined with superior fiber cable management to provide unmatched network design and layout flexibility.

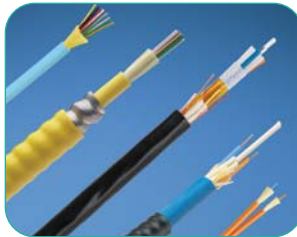

- New Keyed LC System provides the strictest keying integrity available to prevent unauthorized mating and ensure network physical layer security
- Opti-Core® Fiber Optic Cable features the highest quality OM4, OM3, OM2, OM1 and OS1/OS2 fiber to support and extend infrastructure life cycle
- OptiCam® Pre-Polished Connectors and field polish connectors offer connector and termination selections to meet network requirements and installation preferences
- QuickNet™ Cabling System components are terminated, tested, and configured to fit the application, offering quick, plug-in deployment for trouble-free network performance
- Opticom® and QuickNet™ Enclosures enable fast and easy field installation, and organize, manage, and protect fiber connections in compact, high-density applications
- Mini-Com® Adapter Modules and Opticom® Fiber Adapter Panels enable easy MACs to provide system modularity and scalability for easy upgrades and future network growth
- Opti-Core® Patch Cords and QuickNet™ Cable Assemblies are designed to fit the application to minimize waste, optimize cable management, and speed deployment

Panduit fiber optic systems include a full line of innovative, end-to-end, high performance products for all fiber optic applications. These advanced fiber optic systems are comprised of a broad selection of high performance fiber optic cable, connectors, adapter modules, adapter panels, cassettes, enclosures, patch cords, cable assemblies, cable distribution products and accessories for both singlemode and multimode applications. Together, these components provide complete solutions for today's high data rate Fibre Channel and Ethernet applications, and support future readiness for 40 Gb/s and 100 Gb/s data rates, maximizing physical infrastructure performance, modularity, and scalability.

Fiber Optic Systems Roadmaps

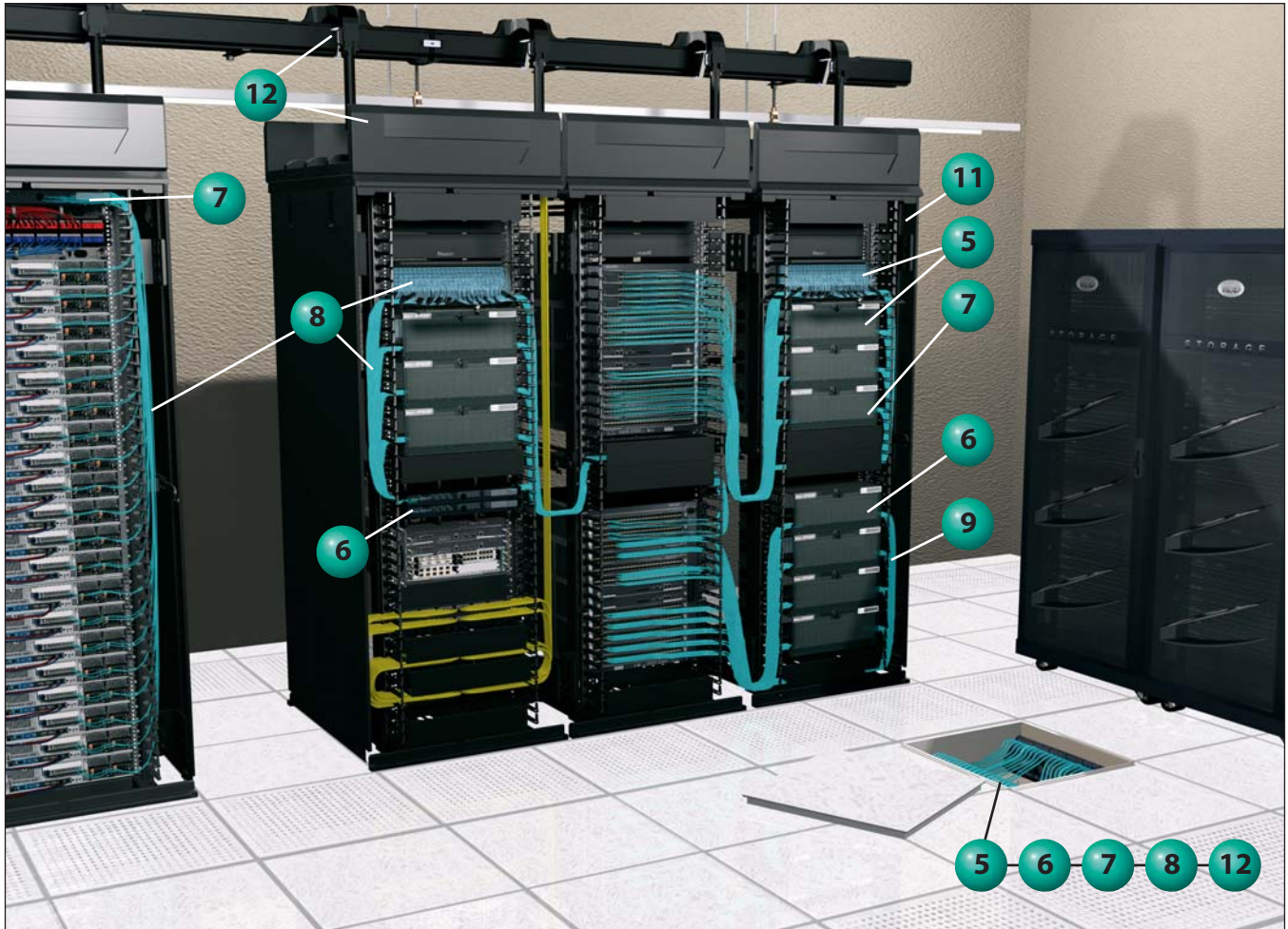

Data Center and SAN

1 Opti-Core® Fiber Optic Cable (Indoor, Indoor/Outdoor, and Outside Plant) (pages C.4 – C.18)





2 Fiber Optic Connectors (LC, Keyed LC, SC, ST, FJ* Jack Modules and Plugs) (pages C.19 – C.27) 





3 Fiber Optic Adapters (LC, SC, and ST) (pages C.28 – C.31)





4 Mini-Com® Adapter Modules (MPO, LC, Keyed LC, SC, ST, FC, MT-RJ) (pages C.31 – C.36) 



5 Opticom® Fiber Adapter Panels (FAPs) (LC, Keyed LC, SC, ST, MT-RJ, FC) (pages C.37 – C.43) 







6 QuickNet™ SFQ Series and QuickNet™ MTP* Cassettes (pages C.43 – C.53) 

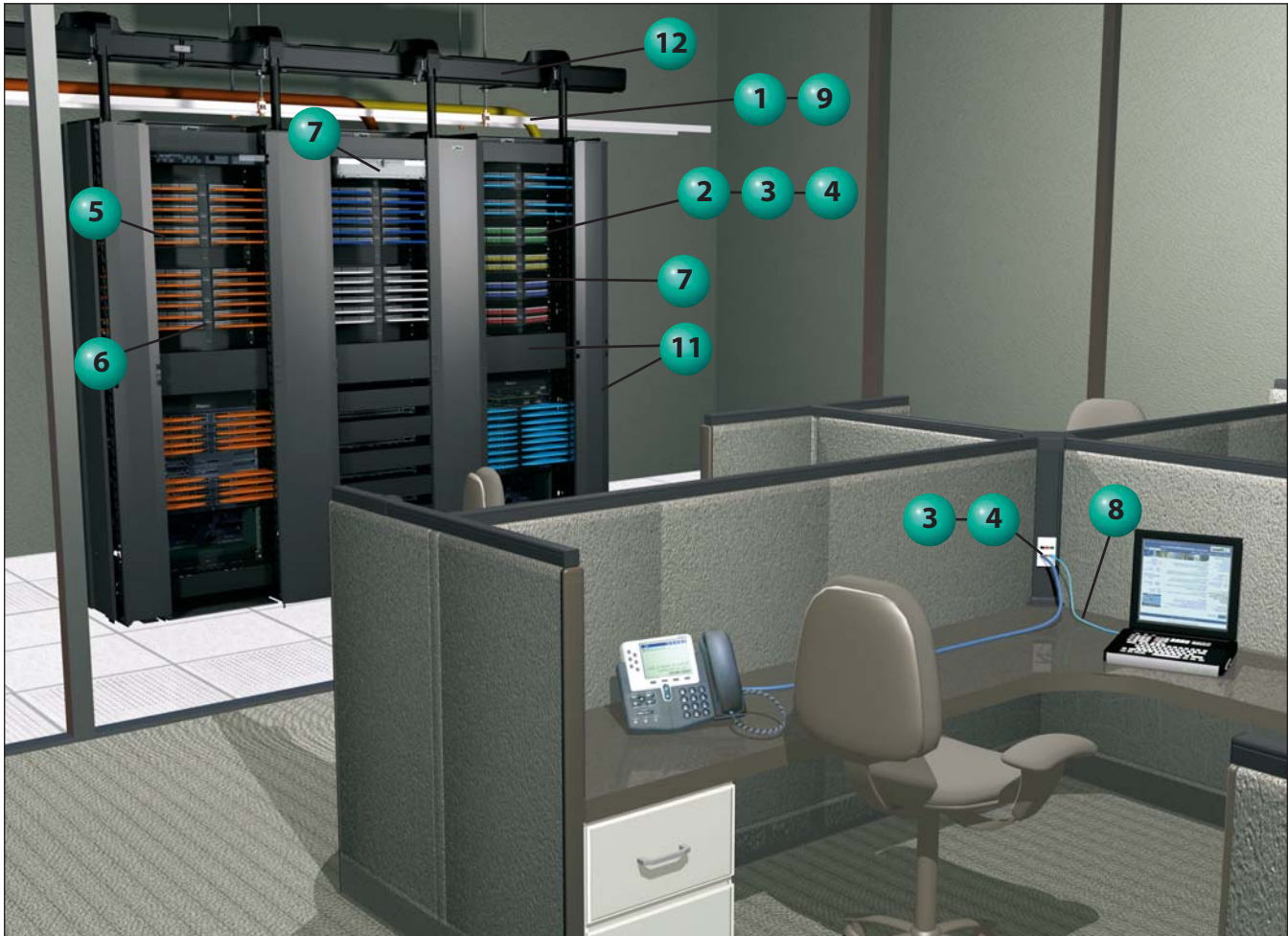

*MTP is a registered trademark of US Conec Ltd.

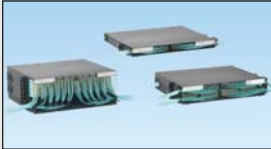

Telecommunications Room and Work Area

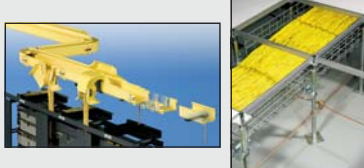
<p>7 Opticom® and QuickNet™ Enclosures, Trays, Patch Panels, and Accessories (pages C.54 – C.62)</p> 	<p>10 OptiCam®, Opti-Crimp®, and Field Polish Fiber Optic Termination Kits and Tools (pages C.101 – C.106)</p> 
<p>8 Opti-Core® Fiber Optic Patch Cords, Pigtails, and Reference Cable Assemblies (C.63, C.71 and C.83 – C.89)</p> 	<p>11 Cabinets, Racks, and Cable Management (pages L.1 – L.74)</p> 
<p>9 QuickNet™ Hydra, Interconnect, MTP®, and Traditional Trunk Cable Assemblies (pages C.91 – C.100)</p> 	<p>12 Overhead and Underfloor Routing (pages J.1 – J.80)</p> 

*MTP is a registered trademark of US Conec Ltd.

**Opti-Core[®] Fiber Optic Distribution Cable**

- Used in intrabuilding backbone, building backbone, and horizontal installations for riser (OFNR), plenum (OFNP), and general-purpose environments
- Available in 6, 12, and 24-fiber counts in a “single jacket” design, and in 36, 48, 72, 96 and 144-fiber counts in a “subunit” design
- Multimode (OM4, OM3, OM2, and OM1) and singlemode (OS1/OS2) fiber available
- Sheath markings provide positive identification, quality traceability, and length verification

- Cable design and flexible buffer tubes allow for quick breakout and ease of routing
- 900µm standards-based color-coded buffer coating protects fibers during handling and allows for easy identification and stripping
- Opti-Core[®] 10Gig[™] Fiber Optic Cable is designed to support network transmission speeds up to 10 Gb/s for link lengths up to 300 meters for OM3 and up to 550 meters for OM4 with an 850nm source per IEEE 802.3ae 10 GbE standard; backward compatible for use with all 50/125µm system requirements

**FODRZ06Y****FSDR606Y****FSDR948Y**

Part Number	Part Description	Fiber Count*	Color
-------------	------------------	--------------	-------

Opti-Core[®] Riser Distribution Cable (OFNR) – Multimode

FODRZ06Y	6-fiber 10Gig [™] 50/125µm (OM4) multimode riser rated distribution cable.	6	Aqua
FODRZ12Y	12-fiber 10Gig [™] 50/125µm (OM4) multimode riser rated distribution cable.	12	Aqua
FODRZ24Y	24-fiber 10Gig [™] 50/125µm (OM4) multimode riser rated distribution cable.	24	Aqua
FODRZ36Y	36-fiber 10Gig [™] 50/125µm (OM4) multimode riser rated distribution cable; six subunits of six fibers each.	36	Aqua
FODRX06Y	6-fiber 10Gig [™] 50/125µm (OM3) multimode riser rated distribution cable.	6	Aqua
FODRX12Y	12-fiber 10Gig [™] 50/125µm (OM3) multimode riser rated distribution cable.	12	Aqua
FODRX24Y	24-fiber 10Gig [™] 50/125µm (OM3) multimode riser rated distribution cable.	24	Aqua
FODRX36Y	36-fiber 10Gig [™] 50/125µm (OM3) multimode riser rated distribution cable; six subunits of six fibers each.	36	Aqua
FSDR506Y	6-fiber 50/125µm (OM2) multimode riser rated distribution cable.	6	Orange
FSDR512Y	12-fiber 50/125µm (OM2) multimode riser rated distribution cable.	12	Orange
FSDR524Y	24-fiber 50/125µm (OM2) multimode riser rated distribution cable.	24	Orange
FSDR536Y	36-fiber 50/125µm (OM2) multimode riser rated distribution cable; six subunits of six fibers each.	36	Orange
FSDR606Y	6-fiber 62.5/125µm (OM1) multimode riser rated distribution cable.	6	Orange
FSDR612Y	12-fiber 62.5/125µm (OM1) multimode riser rated distribution cable.	12	Orange
FSDR624Y	24-fiber 62.5/125µm (OM1) multimode riser rated distribution cable.	24	Orange
FSDR636Y	36-fiber 62.5/125µm (OM1) multimode riser rated distribution cable; six subunits of six fibers each.	36	Orange

Opti-Core[®] Riser Distribution Cable (OFNR) – Singlemode

FSDR906Y	6-fiber 9/125µm (OS1/OS2) singlemode riser rated distribution cable.	6	Yellow
FSDR912Y	12-fiber 9/125µm (OS1/OS2) singlemode riser rated distribution cable.	12	Yellow
FSDR924Y	24-fiber 9/125µm (OS1/OS2) singlemode riser rated distribution cable.	24	Yellow
FSDR936Y	36-fiber 9/125µm (OS1/OS2) singlemode riser rated distribution cable; six subunits of six fibers each.	36	Yellow

*For fiber counts greater than 36-fibers, replace 36 in part number with desired fiber count: 48, 72, 96, or 1A (for 144-fibers).

Contact Customer Service for minimum order quantities, availability, and additional product configurations. Options include fiber counts, jacket colors, hybrid constructions (multiple fiber types within a single cable), flame ratings, subunit counts, armoring, premium optical performance grades and ribbonized constructions.



Opti-Core® Fiber Optic Distribution Cable (continued)



FODPX12Y



FSDP606Y



FSDP948Y

Part Number	Part Description	Fiber Count*	Color
Opti-Core® Plenum Distribution Cable (OFNP) – Multimode			
FODPZ06Y	6-fiber 10Gig™ 50/125µm (OM4) multimode plenum rated distribution cable.	6	Aqua
FODPZ12Y	12-fiber 10Gig™ 50/125µm (OM4) multimode plenum rated distribution cable.	12	Aqua
FODPZ24Y	24-fiber 10Gig™ 50/125µm (OM4) multimode plenum rated distribution cable.	24	Aqua
FODPZ36Y	36-fiber 10Gig™ 50/125µm (OM4) multimode plenum rated distribution cable; six subunits of six fibers each.	36	Aqua
FODPX06Y	6-fiber 10Gig™ 50/125µm (OM3) multimode plenum rated distribution cable.	6	Aqua
FODPX12Y	12-fiber 10Gig™ 50/125µm (OM3) multimode plenum rated distribution cable.	12	Aqua
FODPX24Y	24-fiber 10Gig™ 50/125µm (OM3) multimode plenum rated distribution cable.	24	Aqua
FODPX36Y	36-fiber 10Gig™ 50/125µm (OM3) multimode plenum rated distribution cable; six subunits of six fibers each.	36	Aqua
FSDP506Y	6-fiber 50/125µm (OM2) multimode plenum rated distribution cable.	6	Orange
FSDP512Y	12-fiber 50/125µm (OM2) multimode plenum rated distribution cable.	12	Orange
FSDP524Y	24-fiber 50/125µm (OM2) multimode plenum rated distribution cable.	24	Orange
FSDP536Y	36-fiber 50/125µm (OM2) multimode plenum rated distribution cable; six subunits of six fibers each.	36	Orange
FSDP606Y	6-fiber 62.5/125µm (OM1) multimode plenum rated distribution cable.	6	Orange
FSDP612Y	12-fiber 62.5/125µm (OM1) multimode plenum rated distribution cable.	12	Orange
FSDP624Y	24-fiber 62.5/125µm (OM1) multimode plenum rated distribution cable.	24	Orange
FSDP636Y	36-fiber 62.5/125µm (OM1) multimode plenum rated distribution cable; six subunits of six fibers each.	36	Orange

Opti-Core® Plenum Distribution Cable (OFNP) – Singlemode

FSDP906Y	6-fiber 9/125µm (OS1/OS2) singlemode plenum rated distribution cable.	6	Yellow
FSDP912Y	12-fiber 9/125µm (OS1/OS2) singlemode plenum rated distribution cable.	12	Yellow
FSDP924Y	24-fiber 9/125µm (OS1/OS2) singlemode plenum rated distribution cable.	24	Yellow
FSDP936Y	36-fiber 9/125µm (OS1/OS2) singlemode plenum rated distribution cable; six subunits of six fibers each.	36	Yellow

*For fiber counts greater than 36-fibers, replace 36 in part number with desired fiber count: 48, 72, 96, or 1A (for 144-fibers).

Contact Customer Service for minimum order quantities, availability, and additional product configurations. Options include fiber counts, jacket colors, hybrid constructions (multiple fiber types within a single cable), flame ratings, subunit counts, armoring, premium optical performance grades and ribbonized constructions.

Labels for Opti-Core® Fiber Optic Distribution Cable

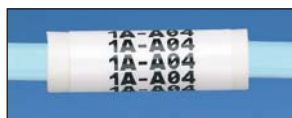

Fiber Count	Suggested Label Solutions for TIA/EIA-606-A Compliance			
	Laser/Ink Jet Desktop Printer Label	TDP43ME Thermal Transfer Desktop Printer Label	PanTher™ LS8E Hand-Held Printer Label	Cougar™ LS9 Hand-Held Printer Label
6	S100X150YAJ	S100X150VATY	S100X150VAC	T100X000CBC-BK
12	S100X225YAJ	S100X225VATY	S100X225VAC	T100X000CBC-BK
24	S100X225YAJ	S100X225VATY	S100X225VAC	T100X000CBC-BK
36	S100X650YAJ	S100X650VATY	S100X650VAC	T100X000CBC-BK
48	S100X650YAJ	S100X650VATY	S100X650VAC	T100X000CBC-BK

For complete labeling solutions and product information, reference charts on pages O.1 – O.18.

**Opti-Core[®] Fiber Optic Indoor Interlocking Armored Cable**

- Used in intrabuilding backbone, building backbone, and horizontal installations for riser (OFCR), plenum (OFCP), and harsh environments
- Interlocking aluminum armor eliminates the need for inner duct or conduit to provide a smaller crush resistant pathway for design flexibility and a lower installed cost
- Available in 6, 12, 24, 36, 48, 72, 96 and 144-fiber counts
- Multimode (OM4, OM3, OM2, and OM1) and singlemode (OS1/OS2) fiber available optimized fiber available
- Sheath markings provide positive identification, quality traceability, and length verification
- 900µm standards-based color-coded buffer coating protects fibers during handling and allows for easy identification and stripping
- Cable design and flexible buffer tubes allow for quick breakout and ease of routing
- Opti-Core[®] 10Gig™ Fiber Optic Cable is designed to support network transmission speeds up to 10 Gb/s for link lengths up to 300 meters for OM3 and up to 550 meters for OM4 with an 850nm source per IEEE 802.3ae 10 GbE standard; backward compatible for use with all 50/125µm system requirements

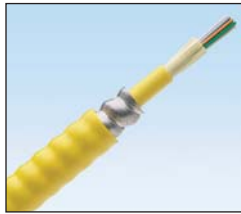
**FSPR912Y**

Part Number	Part Description	Fiber Count*	Color
Opti-Core[®] Riser Indoor Interlocking Armored Cable (OFCR) – Multimode			
FOPRZ06Y	6-fiber 10Gig™ 50/125µm (OM4) multimode riser rated indoor interlocking armored cable.	6	Aqua
FOPRZ12Y	12-fiber 10Gig™ 50/125µm (OM4) multimode riser rated indoor interlocking armored cable.	12	Aqua
FOPRZ24Y	24-fiber 10Gig™ 50/125µm (OM4) multimode riser rated indoor interlocking armored cable.	24	Aqua
FOPRZ36Y	36-fiber 10Gig™ 50/125µm (OM4) multimode riser rated indoor interlocking armored cable.	36	Aqua
FOPRX06Y	6-fiber 10Gig™ 50/125µm (OM3) multimode riser rated indoor interlocking armored cable.	6	Aqua
FOPRX12Y	12-fiber 10Gig™ 50/125µm (OM3) multimode riser rated indoor interlocking armored cable.	12	Aqua
FOPRX24Y	24-fiber 10Gig™ 50/125µm (OM3) multimode riser rated indoor interlocking armored cable.	24	Aqua
FOPRX36Y	36-fiber 10Gig™ 50/125µm (OM3) multimode riser rated indoor interlocking armored cable.	36	Aqua
FSPR506Y	6-fiber 50/125µm (OM2) multimode riser rated indoor interlocking armored cable.	6	Orange
FSPR512Y	12-fiber 50/125µm (OM2) multimode riser rated indoor interlocking armored cable.	12	Orange
FSPR524Y	24-fiber 50/125µm (OM2) multimode riser rated indoor interlocking armored cable.	24	Orange
FSPR536Y	36-fiber 50/125µm (OM2) multimode riser rated indoor interlocking armored cable.	36	Orange
FSPR606Y	6-fiber 62.5/125µm (OM1) multimode riser rated indoor interlocking armored cable.	6	Orange
FSPR612Y	12-fiber 62.5/125µm (OM1) multimode riser rated indoor interlocking armored cable.	12	Orange
FSPR624Y	24-fiber 62.5/125µm (OM1) multimode riser rated indoor interlocking armored cable.	24	Orange
FSPR636Y	36-fiber 62.5/125µm (OM1) multimode riser rated indoor interlocking armored cable.	36	Orange
Opti-Core[®] Riser Indoor Interlocking Armored Cable (OFCR) – Singlemode			
FSPR906Y	6-fiber 9/125µm (OS1/OS2) singlemode riser rated indoor interlocking armored cable.	6	Yellow
FSPR912Y	12-fiber 9/125µm (OS1/OS2) singlemode riser rated indoor interlocking armored cable.	12	Yellow
FSPR924Y	24-fiber 9/125µm (OS1/OS2) singlemode riser rated indoor interlocking armored cable.	24	Yellow
FSPR936Y	36-fiber 9/125µm (OS1/OS2) singlemode riser rated indoor interlocking armored cable.	36	Yellow

*For fiber counts greater than 36-fibers, replace 36 in part number with desired fiber count: 48, 72, 96, or 1A (for 144-fibers).

Contact Customer Service for minimum order quantities, availability, and additional product configurations. Options include fiber counts, jacket colors, hybrid constructions (multiple fiber types within a single cable), flame ratings, subunit counts, armoring, premium optical performance grades and ribbonized constructions.



Opti-Core® Fiber Optic Indoor Interlocking Armored Cable (continued)

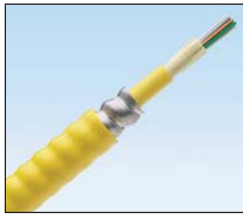

FSP912Y

Part Number	Part Description	Fiber Count*	Color
Opti-Core® Plenum Indoor Interlocking Armored Cable (OFCP) – Multimode			
FOPPZ06Y	6-fiber 10Gig™ 50/125µm (OM4) multimode plenum rated indoor interlocking armored cable.	6	Aqua
FOPPZ12Y	12-fiber 10Gig™ 50/125µm (OM4) multimode plenum rated indoor interlocking armored cable.	12	Aqua
FOPPZ24Y	24-fiber 10Gig™ 50/125µm (OM4) multimode plenum rated indoor interlocking armored cable.	24	Aqua
FOPPZ36Y	36-fiber 10Gig™ 50/125µm (OM4) multimode plenum rated indoor interlocking armored cable.	36	Aqua
FOPPX06Y	6-fiber 10Gig™ 50/125µm (OM3) multimode plenum rated indoor interlocking armored cable.	6	Aqua
FOPPX12Y	12-fiber 10Gig™ 50/125µm (OM3) multimode plenum rated indoor interlocking armored cable.	12	Aqua
FOPPX24Y	24-fiber 10Gig™ 50/125µm (OM3) multimode plenum rated indoor interlocking armored cable.	24	Aqua
FOPPX36Y	36-fiber 10Gig™ 50/125µm (OM3) multimode plenum rated indoor interlocking armored cable.	36	Aqua
FSPP506Y	6-fiber 50/125µm (OM2) multimode plenum rated indoor interlocking armored cable.	6	Orange
FSPP512Y	12-fiber 50/125µm (OM2) multimode plenum rated indoor interlocking armored cable.	12	Orange
FSPP524Y	24-fiber 50/125µm (OM2) multimode plenum rated indoor interlocking armored cable.	24	Orange
FSPP536Y	36-fiber 50/125µm (OM2) multimode plenum rated indoor interlocking armored cable.	36	Orange
FSPP606Y	6-fiber 62.5/125µm (OM1) multimode plenum rated indoor interlocking armored cable.	6	Orange
FSPP612Y	12-fiber 62.5/125µm (OM1) multimode plenum rated indoor interlocking armored cable.	12	Orange
FSPP624Y	24-fiber 62.5/125µm (OM1) multimode plenum rated indoor interlocking armored cable.	24	Orange
FSPP636Y	36-fiber 62.5/125µm (OM1) multimode plenum rated indoor interlocking armored cable.	36	Orange
Opti-Core® Plenum Indoor Interlocking Armored Cable (OFCP) – Singlemode			
FSP906Y	6-fiber 9/125µm (OS1/OS2) singlemode plenum rated indoor interlocking armored cable.	6	Yellow
FSP912Y	12-fiber 9/125µm (OS1/OS2) singlemode plenum rated indoor interlocking armored cable.	12	Yellow
FSP924Y	24-fiber 9/125µm (OS1/OS2) singlemode plenum rated indoor interlocking armored cable.	24	Yellow
FSP936Y	36-fiber 9/125µm (OS1/OS2) singlemode plenum rated indoor interlocking armored cable.	36	Yellow

*For fiber counts greater than 36-fibers, replace 36 in part number with desired fiber count: 48, 72, 96, or 1A (for 144-fibers).

Contact Customer Service for minimum order quantities, availability, and additional product configurations. Options include fiber counts, jacket colors, hybrid constructions (multiple fiber types within a single cable), flame ratings, subunit counts, armoring, premium optical performance grades and ribbonized constructions.

Labels for Opti-Core® Fiber Optic Indoor Interlocking Armored Cable

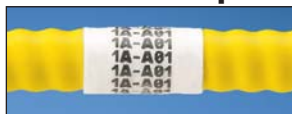

Suggested Label Solutions for TIA/EIA-606-A Compliance				
Fiber Count	Laser/Ink Jet Desktop Printer Label	TDP43ME Thermal Transfer Desktop Printer Label	PanTher™ LS8E Hand-Held Printer Label	Cougar™ LS9 Hand-Held Printer Label
6	S100X225YAJ	S100X225VATY	S100X225VAC	T100X000CBC-BK
12				
24	S100X650YAJ	S100X650VATY	S100X650VAC	T100X000CBC-BK
36				
48				
72				
96				
144				

For complete labeling solutions and product information, reference charts on pages O.1 – O.18.



Opti-Core® Gel-Free Fiber Optic Indoor/Outdoor All-Dielectric Cable

- Allows installation using loose tube cable methods within buildings and outdoor environments for transitional aerial and duct applications, and in entrance facilities that require riser (OFNR) or plenum (OFNP) rated cable
- Eliminates the need for building entrance transition point
- All-dielectric cable construction requires no grounding or bonding
- UV resistant cable sheathing meets the light absorption requirement defined by Telcordia GR-20, Issue 2 to withstand harsh outdoor environmental demands
- Dry water-blocking technology allows rapid cable preparation and termination for lower termination costs and time (no messy gel required)
- Available in 6 and 12-fiber counts in “central loose tube” design, and in 24, 36, 48, 72, 96 and 144-fiber counts in a “stranded loose tube” design
- Multimode (OM4, OM3, OM2, and OM1) and singlemode (OS1/OS2) fiber available
- Sheath markings provide positive identification, quality traceability, and length verification
- 250µm buffer coating protects fibers during handling and allows for ease of stripping
- Opti-Core® 10Gig™ Fiber Optic Cable is designed to support network transmission speeds up to 10 Gb/s for link lengths up to 300 meters for OM3 and up to 550 meters for OM4 with an 850nm source per IEEE 802.3ae 10 GbE standard; backward compatible for use with all 50/125µm system requirements



FSCR606Y



FSCR606Y

Part Number	Part Description	Fiber Count*	Color
Opti-Core® Gel-Free Riser Indoor/Outdoor All-Dielectric Cable (OFNR) – Multimode			
FOCRZ06Y	6-fiber 10Gig™ 50/125µm (OM4) multimode riser rated indoor/outdoor central cable.	6	Black
FOCRZ12Y	12-fiber 10Gig™ 50/125µm (OM4) multimode riser rated indoor/outdoor central cable.	12	Black
FONRZ24Y	24-fiber 10Gig™ 50/125µm (OM4) multimode riser rated indoor/outdoor stranded cable.	24	Black
FONRZ36Y	36-fiber 10Gig™ 50/125µm (OM4) multimode riser rated indoor/outdoor stranded cable.	36	Black
FOCRX06Y	6-fiber 10Gig™ 50/125µm (OM3) multimode riser rated indoor/outdoor central cable.	6	Black
FOCRX12Y	12-fiber 10Gig™ 50/125µm (OM3) multimode riser rated indoor/outdoor central cable.	12	Black
FONRX24Y	24-fiber 10Gig™ 50/125µm (OM3) multimode riser rated indoor/outdoor stranded cable.	24	Black
FONRX36Y	36-fiber 10Gig™ 50/125µm (OM3) multimode riser rated indoor/outdoor stranded cable.	36	Black
FSCR506Y	6-fiber 50/125µm (OM2) multimode riser rated indoor/outdoor central cable.	6	Black
FSCR512Y	12-fiber 50/125µm (OM2) multimode riser rated indoor/outdoor central cable.	12	Black
FSNR524Y	24-fiber 50/125µm (OM2) multimode riser rated indoor/outdoor stranded cable.	24	Black
FSNR536Y	36-fiber 50/125µm (OM2) multimode riser rated indoor/outdoor stranded cable.	36	Black
FSCR606Y	6-fiber 62.5/125µm (OM1) multimode riser rated indoor/outdoor central cable.	6	Black
FSCR612Y	12-fiber 62.5/125µm (OM1) multimode riser rated indoor/outdoor central cable.	12	Black
FSNR624Y	24-fiber 62.5/125µm (OM1) multimode riser rated indoor/outdoor stranded cable.	24	Black
FSNR636Y	36-fiber 62.5/125µm (OM1) multimode riser rated indoor/outdoor stranded cable.	36	Black

Opti-Core® Gel-Free Riser Indoor/Outdoor All-Dielectric Cable (OFNR) – Singlemode

FSCR906Y	6-fiber 9/125µm (OS1/OS2) singlemode riser rated indoor/outdoor central cable.	6	Black
FSCR912Y	12-fiber 9/125µm (OS1/OS2) singlemode riser rated indoor/outdoor central cable.	12	Black
FSNR924Y	24-fiber 9/125µm (OS1/OS2) singlemode riser rated indoor/outdoor stranded cable.	24	Black
FSNR936Y	36-fiber 9/125µm (OS1/OS2) singlemode riser rated indoor/outdoor stranded cable. 6-fiber 10Gig™ 50/125µm (OM3) multimode plenum rated indoor/outdoor central cable.	36	Black

*For fiber counts greater than 36-fibers, replace 36 in part number with desired fiber count: 48, 72, 96, or 1A (for 144-fibers).

Contact Customer Service for minimum order quantities, availability, and additional product configurations. Options include fiber counts, jacket colors, hybrid constructions (multiple fiber types within a single cable), flame ratings, subunit counts, armoring, premium optical performance grades and ribbonized constructions.



Opti-Core® Gel-Free Fiber Optic Indoor/Outdoor All-Dielectric Cable (continued)



FONPX24Y



FSCP606Y

Part Number	Part Description	Fiber Count*	Color
-------------	------------------	--------------	-------

Opti-Core® Gel-Free Plenum Indoor/Outdoor All-Dielectric Cable (OFNP) – Multimode

F0CPZ06Y	6-fiber 10Gig™ 50/125µm (OM4) multimode plenum rated indoor/outdoor central cable.	6	Aqua
F0CPZ12Y	12-fiber 10Gig™ 50/125µm (OM4) multimode plenum rated indoor/outdoor central cable.	12	Aqua
F0NPZ24Y	24-fiber 10Gig™ 50/125µm (OM4) multimode plenum rated indoor/outdoor stranded cable.	24	Aqua
F0NPZ36Y	36-fiber 10Gig™ 50/125µm (OM4) multimode plenum rated indoor/outdoor stranded cable.	36	Aqua
F0CPX06Y	6-fiber 10Gig™ 50/125µm (OM3) multimode plenum rated indoor/outdoor central cable.	6	Aqua
F0CPX12Y	12-fiber 10Gig™ 50/125µm (OM3) multimode plenum rated indoor/outdoor central cable.	12	Aqua
F0NPX24Y	24-fiber 10Gig™ 50/125µm (OM3) multimode plenum rated indoor/outdoor stranded cable.	24	Aqua
F0NPX36Y	36-fiber 10Gig™ 50/125µm (OM3) multimode plenum rated indoor/outdoor stranded cable.	36	Aqua
F5CP506Y	6-fiber 50/125µm (OM2) multimode plenum rated indoor/outdoor central cable.	6	Orange
F5CP512Y	12-fiber 50/125µm (OM2) multimode plenum rated indoor/outdoor central cable.	12	Orange
F5NP524Y	24-fiber 50/125µm (OM2) multimode plenum rated indoor/outdoor stranded cable.	24	Orange
F5NP536Y	36-fiber 50/125µm (OM2) multimode plenum rated indoor/outdoor stranded cable.	36	Orange
F5CP606Y	6-fiber 62.5/125µm (OM1) multimode plenum rated indoor/outdoor central cable.	6	Orange
F5CP612Y	12-fiber 62.5/125µm (OM1) multimode plenum rated indoor/outdoor central cable.	12	Orange
F5NP624Y	24-fiber 62.5/125µm (OM1) multimode plenum rated indoor/outdoor stranded cable.	24	Orange
F5NP636Y	36-fiber 62.5/125µm (OM1) multimode plenum rated indoor/outdoor stranded cable.	36	Orange

Opti-Core® Gel-Free Plenum Indoor/Outdoor All-Dielectric Cable (OFNP) – Singlemode

F5CP906Y	6-fiber 9/125µm (OS1/OS2) singlemode plenum rated indoor/outdoor central cable.	6	Yellow
F5CP912Y	12-fiber 9/125µm (OS1/OS2) singlemode plenum rated indoor/outdoor central cable.	12	Yellow
F5NP924Y	24-fiber 9/125µm (OS1/OS2) singlemode plenum rated indoor/outdoor stranded cable.	24	Yellow
F5NP936Y	36-fiber 9/125µm (OS1/OS2) singlemode plenum rated indoor/outdoor stranded cable.	36	Yellow

*For fiber counts greater than 36-fibers, replace 36 in part number with desired fiber count: 48, 72, 96, or 1A (for 144-fibers).

Contact Customer Service for minimum order quantities, availability, and additional product configurations. Options include fiber counts, jacket colors, hybrid constructions (multiple fiber types within a single cable), flame ratings, subunit counts, armoring, premium optical performance grades and ribbonized constructions.

Labels for Opti-Core[®] Gel-Free Fiber Optic Indoor/Outdoor All-Dielectric Cable

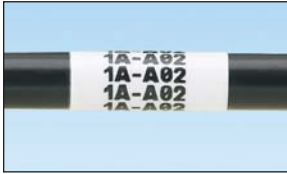

Suggested Label Solutions for TIA/EIA-606-A Compliance

Fiber Count	Laser/Ink Jet Desktop Printer Label	TDP43ME Thermal Transfer Desktop Printer Label	PanTher™ LS8E Hand-Held Printer Label	Cougar™ LS9 Hand-Held Printer Label
6	S100X225YAJ	S100X225VATY	S100X225VAC	T100X000CBC-BK
12				
24				
36				
48				
72				
96				
144				

For complete labeling solutions and product information, reference charts on pages O.1 – O.18.



Opti-Core® Gel-Free Fiber Optic Indoor/Outdoor Interlocking Armored Cable

- Allows installation using loose tube cable methods within buildings and outdoor environments for transitional aerial and duct applications, and in entrance facilities that require riser (OFCR) or plenum (OFPC) rated cable
- Eliminates the need for building entrance transition point
- Interlocking aluminum armor eliminates the need for inner duct or conduit to provide a smaller crush resistant pathway for design flexibility and a lower installed cost
- UV resistant cable sheathing meets the light absorption requirement defined by Telcordia GR-20, Issue 2 to withstand harsh outdoor environmental demands
- Dry water-blocking technology allows rapid cable preparation and termination for lower termination costs and time (no messy gel required)
- Available in 6 and 12-fiber counts in “central loose tube” design, and in 24, 36, 48, 72, 96 and 144-fiber counts in a “stranded loose tube” design
- Multimode (OM4, OM3, OM2, and OM1) and singlemode (OS1/OS2) fiber available
- Sheath markings provide positive identification, quality traceability, and length verification
- 250µm buffer coating protects fibers during handling and allows for ease of stripping
- Opti-Core® 10Gig™ Fiber Optic Cable is designed to support network transmission speeds up to 10 Gb/s for link lengths up to 300 meters for OM3 and up to 550 meters for OM4 with an 850nm source per IEEE 802.3ae 10 GbE standard; backward compatible for use with all 50/125µm system requirements



FSGR606Y



FSGR606Y

Part Number	Part Description	Fiber Count*	Color
-------------	------------------	--------------	-------

Opti-Core® Gel-Free Riser Indoor/Outdoor Interlocking Armored Cable (OFCR) – Multimode

F0GRZ06Y	6-fiber 10Gig™ 50/125µm (OM4) multimode riser rated indoor/outdoor interlocking armored central cable.	6	Aqua
F0GRZ12Y	12-fiber 10Gig™ 50/125µm (OM4) multimode riser rated indoor/outdoor interlocking armored central cable.	12	Aqua
F0MRZ24Y	24-fiber 10Gig™ 50/125µm (OM4) multimode riser rated indoor/outdoor interlocking armored stranded cable.	24	Aqua
F0MRZ36Y	36-fiber 10Gig™ 50/125µm (OM4) multimode riser rated indoor/outdoor interlocking armored stranded cable.	36	Aqua
F0GRX06Y	6-fiber 10Gig™ 50/125µm (OM3) multimode riser rated indoor/outdoor interlocking armored central cable.	6	Aqua
F0GRX12Y	12-fiber 10Gig™ 50/125µm (OM3) multimode riser rated indoor/outdoor interlocking armored central cable.	12	Aqua
F0MRX24Y	24-fiber 10Gig™ 50/125µm (OM3) multimode riser rated indoor/outdoor interlocking armored stranded cable.	24	Aqua
F0MRX36Y	36-fiber 10Gig™ 50/125µm (OM3) multimode riser rated indoor/outdoor interlocking armored stranded cable.	36	Aqua
F5GR506Y	6-fiber 50/125µm (OM2) multimode riser rated indoor/outdoor interlocking armored central cable.	6	Black
F5GR512Y	12-fiber 50/125µm (OM2) multimode riser rated indoor/outdoor interlocking armored central cable.	12	Black
F5MR524Y	24-fiber 50/125µm (OM2) multimode riser rated indoor/outdoor interlocking armored stranded cable.	24	Black
F5MR536Y	36-fiber 50/125µm (OM2) multimode riser rated indoor/outdoor interlocking armored stranded cable.	36	Black
F6GR606Y	6-fiber 62.5/125µm (OM1) multimode riser rated indoor/outdoor interlocking armored central cable.	6	Black
F6GR612Y	12-fiber 62.5/125µm (OM1) multimode riser rated indoor/outdoor interlocking armored central cable.	12	Black
F6MR624Y	24-fiber 62.5/125µm (OM1) multimode riser rated indoor/outdoor interlocking armored stranded cable.	24	Black
F6MR636Y	36-fiber 62.5/125µm (OM1) multimode riser rated indoor/outdoor interlocking armored stranded cable.	36	Black

Opti-Core® Gel-Free Riser Indoor/Outdoor Interlocking Armored Cable (OFCR) – Singlemode

F9GR906Y	6-fiber 9/125µm (OS1/OS2) singlemode riser rated indoor/outdoor interlocking armored central cable.	6	Black
F9GR912Y	12-fiber 9/125µm (OS1/OS2) singlemode riser rated indoor/outdoor interlocking armored central cable.	12	Black
F9MR924Y	24-fiber 9/125µm (OS1/OS2) singlemode riser rated indoor/outdoor interlocking armored stranded cable.	24	Black
F9MR936Y	36-fiber 9/125µm (OS1/OS2) singlemode riser rated indoor/outdoor interlocking armored stranded cable.	36	Black

*For fiber counts greater than 36-fibers, replace 36 in part number with desired fiber count: 48, 72, 96, or 1A (for 144-fibers). Contact Customer Service for minimum order quantities, availability, and additional product configurations. Options include fiber counts, jacket colors, hybrid constructions (multiple fiber types within a single cable), flame ratings, subunit counts, armoring, premium optical performance grades and ribbonized constructions.

Table continues on page C.12

**Opti-Core[®] Gel-Free Fiber Optic Indoor/Outdoor Interlocking Armored Cable (continued)****FOMPX24Y****FSGP606Y**

Part Number	Part Description	Fiber Count*	Color
Opti-Core[®] Gel-Free Plenum Indoor/Outdoor Interlocking Armored Cable (OFCP) – Multimode			
FOGPZ06Y	6-fiber 10Gig [™] 50/125µm (OM4) multimode plenum rated indoor/outdoor interlocking armored central cable.	6	Aqua
FOGPZ12Y	12-fiber 10Gig [™] 50/125µm (OM4) multimode plenum rated indoor/outdoor interlocking armored central cable.	12	Aqua
FOMPZ24Y	24-fiber 10Gig [™] 50/125µm (OM4) multimode plenum rated indoor/outdoor interlocking armored stranded cable.	24	Aqua
FOMPZ36Y	36-fiber 10Gig [™] 50/125µm (OM4) multimode plenum rated indoor/outdoor interlocking armored stranded cable.	36	Aqua
FOGPX06Y	6-fiber 10Gig [™] 50/125µm (OM3) multimode plenum rated indoor/outdoor interlocking armored central cable.	6	Aqua
FOGPX12Y	12-fiber 10Gig [™] 50/125µm (OM3) multimode plenum rated indoor/outdoor interlocking armored central cable.	12	Aqua
FOMPX24Y	24-fiber 10Gig [™] 50/125µm (OM3) multimode plenum rated indoor/outdoor interlocking armored stranded cable.	24	Aqua
FOMPX36Y	36-fiber 10Gig [™] 50/125µm (OM3) multimode plenum rated indoor/outdoor interlocking armored stranded cable.	36	Aqua
FSGP506Y	6-fiber 50/125µm (OM2) multimode plenum rated indoor/outdoor interlocking armored central cable.	6	Orange
FSGP512Y	12-fiber 50/125µm (OM2) multimode plenum rated indoor/outdoor interlocking armored central cable.	12	Orange
FSMP524Y	24-fiber 50/125µm (OM2) multimode plenum rated indoor/outdoor interlocking armored stranded cable.	24	Orange
FSMP536Y	36-fiber 50/125µm (OM2) multimode plenum rated indoor/outdoor interlocking armored stranded cable.	36	Orange
FSGP606Y	6-fiber 62.5/125µm (OM1) multimode plenum rated indoor/outdoor interlocking armored central cable.	6	Orange
FSGP612Y	12-fiber 62.5/125µm (OM1) multimode plenum rated indoor/outdoor interlocking armored central cable.	12	Orange
FSMP624Y	24-fiber 62.5/125µm (OM1) multimode plenum rated indoor/outdoor interlocking armored stranded cable.	24	Orange
FSMP636Y	36-fiber 62.5/125µm (OM1) multimode plenum rated indoor/outdoor interlocking armored stranded cable.	36	Orange
Opti-Core[®] Gel-Free Plenum Indoor/Outdoor Interlocking Armored Cable (OFCP) – Singlemode			
FSGP906Y	6-fiber 9/125µm (OS1/OS2) singlemode plenum rated indoor/outdoor interlocking armored central cable.	6	Yellow
FSGP912Y	12-fiber 9/125µm (OS1/OS2) singlemode plenum rated indoor/outdoor interlocking armored central cable.	12	Yellow
FSMP924Y	24-fiber 9/125µm (OS1/OS2) singlemode plenum rated indoor/outdoor interlocking armored stranded cable.	24	Yellow
FSMP936Y	36-fiber 9/125µm (OS1/OS2) singlemode plenum rated indoor/outdoor interlocking armored stranded cable.	36	Yellow

*For fiber counts greater than 48-fibers, replace 48 in part number with desired fiber count: 72, 96, or 1A (for 144-fibers). Contact Customer Service for minimum order quantities, availability, and additional product configurations. Options include fiber counts, jacket colors, hybrid constructions (multiple fiber types within a single cable), flame ratings, subunit counts, premium optical performance grades and ribbonized constructions.

Labels for Opti-Core® Gel-Free Fiber Optic Indoor/Outdoor Interlocking Armored Cable



Suggested Label Solutions for TIA/EIA-606-A Compliance				
Fiber Count	Laser/Ink Jet Desktop Printer Label	TDP43ME Thermal Transfer Desktop Printer Label	PanTher™ LS8E Hand-Held Printer Label	Cougar™ LS9 Hand-Held Printer Label
6 12	S100X225YAJ	S100X225VATY	S100X225VAC	T100X000CBC-BK
24 36 48 72 96 144	S100X400YAJ	S100X400VATY	S100X400VAC	T100X000CBC-BK

For complete labeling solutions and product information, reference charts on pages O.1 – O.18.

**Opti-Core[®] Gel-Free Fiber Optic Outside Plant All-Dielectric Cable**

- Allows installation using loose tube cable methods for aerial and duct applications
- Gel-free design with water swellable tape provides dry water blocking
- All-dielectric construction provides a non-metallic design that eliminates the need to bond or ground for aerial or duct applications, allowing easy access to cable for lower installation costs
- UV resistant cable sheathing protects the cable and meets or exceeds the performance requirements of Telcordia GR-20, Issue 2 and ICEA 640 to withstand harsh outdoor environmental demands
- Tested in accordance with relevant EIA-455 series FOTPs for fiber optic cables
- Complies with RUS 7 CFR 1755.900 requirements for fiber optic service entrance cables
- Available in 6, 12, 24, 36, 48, 72, 96 and 144-fiber counts as a “stranded loose tube” design
- Medium density polyethylene jacket provides low friction installation
- Multimode (OM4, OM3, OM2, and OM1) and singlemode (OS1/OS2) fiber available
- Sheath markings provide positive identification, quality traceability, and length verification
- 250µm buffer coating protects fibers during handling and allows for ease of stripping
- Opti-Core[®] 10Gig[™] Fiber Optic Cable is designed to support network transmission speeds up to 10 Gb/s for link lengths up to 300 meters for OM3 and up to 550 meters for OM4 with an 850nm source per IEEE 802.3ae 10 GbE standard; backward compatible for use with all 50/125µm system requirements



Part Number	Part Description	Fiber Count*	Color
-------------	------------------	--------------	-------

Opti-Core[®] Gel-Free Outside Plant All-Dielectric Cable – Multimode

FOTNZ06	6-fiber 10Gig [™] 50/125µm (OM4) multimode outside plant stranded cable.	6	Black
FOTNZ12	12-fiber 10Gig [™] 50/125µm (OM4) multimode outside plant stranded cable.	12	Black
FOTNZ24	24-fiber 10Gig [™] 50/125µm (OM4) multimode outside plant stranded cable.	24	Black
FOTNZ36	36-fiber 10Gig [™] 50/125µm (OM4) multimode outside plant stranded cable.	36	Black
FOTNX06	6-fiber 10Gig [™] 50/125µm (OM3) multimode outside plant stranded cable.	6	Black
FOTNX12	12-fiber 10Gig [™] 50/125µm (OM3) multimode outside plant stranded cable.	12	Black
FOTNX24	24-fiber 10Gig [™] 50/125µm (OM3) multimode outside plant stranded cable.	24	Black
FOTNX36	36-fiber 10Gig [™] 50/125µm (OM3) multimode outside plant stranded cable.	36	Black
FSTN506	6-fiber 50/125µm (OM2) multimode outside plant stranded cable.	6	Black
FSTN512	12-fiber 50/125µm (OM2) multimode outside plant stranded cable.	12	Black
FSTN524	24-fiber 50/125µm (OM2) multimode outside plant stranded cable.	24	Black
FSTN536	36-fiber 50/125µm (OM2) multimode outside plant stranded cable.	36	Black
FSTN606	6-fiber 62.5/125µm (OM1) multimode outside plant stranded cable.	6	Black
FSTN612	12-fiber 62.5/125µm (OM1) multimode outside plant stranded cable.	12	Black
FSTN624	24-fiber 62.5/125µm (OM1) multimode outside plant stranded cable.	24	Black
FSTN636	36-fiber 62.5/125µm (OM1) multimode outside plant stranded cable.	36	Black

Opti-Core[®] Gel-Free Outside Plant All-Dielectric Cable – Singlemode

FSTN906	6-fiber 9/125µm (OS1/OS2) singlemode outside plant stranded cable.	6	Black
FSTN912	12-fiber 9/125µm (OS1/OS2) singlemode outside plant stranded cable.	12	Black
FSTN924	24-fiber 9/125µm (OS1/OS2) singlemode outside plant stranded cable.	24	Black
FSTN936	36-fiber 9/125µm (OS1/OS2) singlemode outside plant stranded cable.	36	Black

*For fiber counts greater than 36-fibers, replace 36 in part number with desired fiber count: 48, 72, 96, or 1A (for 144-fibers).

Contact Customer Service for minimum order quantities, availability, and additional product configurations. Options include fiber counts, jacket colors, hybrid constructions (multiple fiber types within a single cable), flame ratings, subunit counts, armoring, premium optical performance grades and ribbonized constructions.

Labels for Opti-Core® Gel-Free Fiber Optic Outside Plant All-Dielectric Cable



Suggested Label Solutions for TIA/EIA-606-A Compliance				
Fiber Count	Laser/Ink Jet Desktop Printer Label	TDP43ME Thermal Transfer Desktop Printer Label	PanTher™ LS8E Hand-Held Printer Label	Cougar™ LS9 Hand-Held Printer Label
6 12 24 36 48	S100X225YAJ	S100X225VATY	S100X225VAC	T100X000CBC-BK
72 96 144	S100X400YAJ	S100X400VATY	S100X400VAC	T100X000CBC-BK

For complete labeling solutions and product information, reference charts on pages O.1 – O.18.

**Opti-Core[®] Gel-Free Fiber Optic Outside Plant Armored Cable**

- Allows installation using loose tube cable methods for aerial, duct, and direct burial applications
- Gel-free design with water swellable tape provides dry water blocking
- Corrugated steel armor provides superior crush resistance for extended durability in direct burial applications
- UV resistant cable sheathing protects the cable and meets or exceeds the performance requirements of Telcordia GR-20, Issue 2 and ICEA 640 to withstand harsh outdoor environmental demands
- Tested in accordance with relevant EIA-455 series FOTPs for fiber optic cables
- Complies with RUS 7 CFR 1755.900 requirements for fiber optic service entrance cables
- Available in 6, 12, 24, 36, 48, 72, 96 and 144-fiber counts as a “stranded loose tube” design
- Medium density polyethylene jacket provides low friction installation and excellent protection from environmental hazards to extend protection and reliability
- Multimode (OM4, OM3, OM2, and OM1) and singlemode (OS1/OS2) fiber available
- Sheath markings provide positive identification, quality traceability, and length verification
- 250µm buffer coating protects fibers during handling and allows for ease of stripping
- Opti-Core[®] 10Gig[™] Fiber Optic Cable is designed to support network transmission speeds up to 10 Gb/s for link lengths up to 300 meters for OM3 and up to 550 meters for OM4 with an 850nm source per IEEE 802.3ae 10 GbE standard; backward compatible for use with all 50/125µm system requirements



Part Number	Part Description	Fiber Count*	Color
-------------	------------------	--------------	-------

Opti-Core[®] Gel-Free Outside Plant Armored Cable – Multimode

FOWNZ06	6-fiber 10Gig [™] 50/125µm (OM4) multimode outside plant armored stranded cable.	6	Black
FOWNZ12	12-fiber 10Gig [™] 50/125µm (OM4) multimode outside plant armored stranded cable.	12	Black
FOWNZ24	24-fiber 10Gig [™] 50/125µm (OM4) multimode outside plant armored stranded cable.	24	Black
FOWNZ36	36-fiber 10Gig [™] 50/125µm (OM4) multimode outside plant armored stranded cable.	36	Black
FOWNX06	6-fiber 10Gig [™] 50/125µm (OM3) multimode outside plant armored stranded cable.	6	Black
FOWNX12	12-fiber 10Gig [™] 50/125µm (OM3) multimode outside plant armored stranded cable.	12	Black
FOWNX24	24-fiber 10Gig [™] 50/125µm (OM3) multimode outside plant armored stranded cable.	24	Black
FOWNX36	36-fiber 10Gig [™] 50/125µm (OM3) multimode outside plant armored stranded cable.	36	Black
FSWN506	6-fiber 50/125µm (OM2) multimode outside plant armored stranded cable.	6	Black
FSWN512	12-fiber 50/125µm (OM2) multimode outside plant armored stranded cable.	12	Black
FSWN524	24-fiber 50/125µm (OM2) multimode outside plant armored stranded cable.	24	Black
FSWN536	36-fiber 50/125µm (OM2) multimode outside plant armored stranded cable.	36	Black
FSWN606	6-fiber 62.5/125µm (OM1) multimode outside plant armored stranded cable.	6	Black
FSWN612	12-fiber 62.5/125µm (OM1) multimode outside plant armored stranded cable.	12	Black
FSWN624	24-fiber 62.5/125µm (OM1) multimode outside plant armored stranded cable.	24	Black
FSWN636	36-fiber 62.5/125µm (OM1) multimode outside plant armored stranded cable.	36	Black

Opti-Core[®] Gel-Free Outside Plant Armored Cable – Singlemode

FSWN906	6-fiber 9/125µm (OS1/OS2) singlemode outside plant armored stranded cable.	6	Black
FSWN912	12-fiber 9/125µm (OS1/OS2) singlemode outside plant armored stranded cable.	12	Black
FSWN924	24-fiber 9/125µm (OS1/OS2) singlemode outside plant armored stranded cable.	24	Black
FSWN936	36-fiber 9/125µm (OS1/OS2) singlemode outside plant armored stranded cable.	36	Black

*For fiber counts greater than 36-fibers, replace 36 in part number with desired fiber count: 48, 72, 96, or 1A (for 144-fibers).

Contact Customer Service for minimum order quantities, availability, and additional product configurations. Options include fiber counts, jacket colors, hybrid constructions (multiple fiber types within a single cable), flame ratings, subunit counts, armoring, premium optical performance grades and ribbonized constructions.

Labels for Opti-Core® Gel-Free Fiber Optic Outside Plant Armored Cable



Suggested Label Solutions for TIA/EIA-606-A Compliance				
Fiber Count	Laser/Ink Jet Desktop Printer Label	TDP43ME Thermal Transfer Desktop Printer Label	PanTher™ LS8E Hand-Held Printer Label	Cougar™ LS9 Hand-Held Printer Label
6 12 24 36 48	S100X225YAJ	S100X225VATY	S100X225VAC	T100X000CBC-BK
72 96 144	S100X400YAJ	S100X400VATY	S100X400VAC	T100X000CBC-BK

For complete labeling solutions and product information, reference charts on pages O.1 – O.18.



Opti-Core[®] Fiber Optic Interconnect Cable

- Used in interconnect and horizontal installations for riser (OFNR), plenum (OFNP), and general-purpose environments
- Multimode (OM4, OM3, OM2, and OM1) and singlemode (OS1/OS2) fiber available
- Sheath markings provide positive identification, quality traceability, and length verification
- Colored buffers for ease of identification
- High quality buffering offers ease of stripping while maintaining optical performance
- Small diameter and flexible jackets allow for routing in tight spaces such as panels, cable trays, and fiber-to-the-desk (FTTD) applications
- Other diameters available to meet your application needs
- Opti-Core[®] 10Gig[™] Fiber Optic Cable is designed to support network transmission speeds up to 10 Gb/s for link lengths up to 300 meters for OM3 and 550 meters for OM4 with an 850nm source per IEEE 802.3ae 10 GbE standard; backward compatible for use with all 50/125µm system requirements



FSIR602Y



FSIR602Y



FSIP902Y

Part Number	Part Description	Fiber Count	Color
Opti-Core[®] Riser Interconnect Cable (OFNR) – Multimode			
FOIRZ02Y	2-fiber 10Gig [™] 50/125µm (OM4) multimode riser rated interconnect cable; 2.9mm dia., zip-cord.	2	Aqua
FOIRX02Y	2-fiber 10Gig [™] 50/125µm (OM3) multimode riser rated interconnect cable; 2.9mm dia., zip-cord.	2	Aqua
FSIR502Y	2-fiber 50/125µm (OM2) multimode riser rated interconnect cable; 2.9mm dia., zip-cord.	2	Orange
FSIR602Y	2-fiber 62.5/125µm (OM1) multimode riser rated interconnect cable; 2.9mm dia., zip-cord.	2	Orange
Opti-Core[®] Riser Interconnect Cable (OFNR) – Singlemode			
FSIR902Y	2-fiber 9/125µm (OS1/OS2) singlemode riser rated interconnect cable; 2.9mm dia., zip-cord.	2	Yellow
Opti-Core[®] Plenum Interconnect Cable (OFNP) – Multimode			
FOIPZ02Y	2-fiber 10Gig [™] 50/125µm (OM4) multimode plenum rated interconnect cable; 2.9mm dia., zip-cord.	2	Aqua
FOIPX02Y	2-fiber 10Gig [™] 50/125µm (OM3) multimode plenum rated interconnect cable; 2.9mm dia., zip-cord.	2	Aqua
FSIP502Y	2-fiber 50/125µm (OM2) multimode plenum rated interconnect cable; 2.9mm dia., zip-cord.	2	Orange
FSIP602Y	2-fiber 62.5/125µm (OM1) multimode plenum rated interconnect cable; 2.9mm dia., zip-cord.	2	Orange
Opti-Core[®] Plenum Interconnect Cable (OFNP) – Singlemode			
FSIP902Y	2-fiber 9/125µm (OS1/OS2) singlemode plenum rated interconnect cable; 2.9mm dia., zip-cord.	2	Yellow

Contact Customer Service for minimum order quantities, availability, and additional product configurations. Options include diameters, jacket colors, flame ratings and premium optical performance grades.

Labels for Opti-Core[®] Fiber Optic Interconnect Cable



Suggested Label Solutions for TIA/EIA-606-A Compliance				
Fiber Count	Laser/Ink Jet Desktop Printer Label	TDP43ME Thermal Transfer Desktop Printer Label	PanTher [™] LS8E Hand-Held Printer Label	Cougar [™] LS9 Hand-Held Printer Label
2	S100X220YAJ and NWSLC-7Y	S100X225VATY and NWSLC-7Y	S100X220VAC and NWSLC-7Y	T100X000CBC-BK

For complete labeling solutions and product information, reference charts on pages O.1 – O.18.



LC OptiCam® Fiber Optic Connectors – Pre-Polished Cam Termination

- TIA/EIA-604 FOCIS-10 compatible connectors
- Exceed TIA/EIA-568-B.3 requirements
- Connector backbone and boot colors follow TIA/EIA-568-C.3 suggested color identification scheme
- Insertion loss: 0.3dB average (multimode and singlemode)
- Return loss: >26dB (10Gig™ multimode), >20dB (multimode), >50dB (singlemode)
- Spring-loaded “Senior” rear pivot latch LC connector
- Quick installation; provide field termination in less than half the time of field polish connectors
- Patented re-termination capability provides yield rates approaching 100%
- Factory pre-polished fiber endface eliminates time-consuming field polishing to reduce installation costs, labor, scrap and the number of tools required
- Cam activated fiber and buffer clamp mechanisms provide superior fiber and buffer retention – less sensitivity to fiber tensile loading

- OptiCam® Termination Tool simplifies tooling and termination, and virtually eliminates operator error by providing visual indication of proper termination after the cam step has been completed
- Cable retention boot assemblies consistently provide higher than industry standard cable retention
- Non-optical disconnect maintains data transmission under tensile loads for jacketed cable
- Fiber cable size: accept 900µm tight-buffered fiber with included boot(s); accept 1.6mm – 2.0mm and 3.0mm jacketed cable with available OptiCam® Cable Retention Boot Assemblies (ten per package)
- For 250µm coated fiber termination, use 250 micron fiber build-up tube kit or fan-out kits on pages C.27 – C.28
- Ferrule type: 1.25mm zirconia ceramic (highest durability for repeated matings)
- Use OptiCam® Termination Kit (FCAMKIT) on page C.101



FLCDMCXAQY



FLCDMC5BLY



FLCDMC6E1Y



FLCSSCBUY



FMCBT2AQ-X



FLCCLIPBL-L

Part Number	Part Description	Color	Std. Pkg. Qty.*	Std. Ctn. Qty.
LC OptiCam® 10Gig™ OM3/OM4 50/125µm Multimode Fiber Optic Connectors				
FLCDMCXAQY	LC OptiCam® 10Gig™ 50/125µm Multimode Simplex Fiber Optic Connector for 900µm tight-buffered fiber installation.	Aqua	1	10
FLCDMCXAQY	LC OptiCam® 10Gig™ 50/125µm Multimode Duplex Fiber Optic Connector for 900µm tight-buffered fiber installation.	Aqua	1	10
LC OptiCam® OM2 50/125µm Multimode Fiber Optic Connectors				
FLCDMC5BLY	LC OptiCam® 50/125µm Multimode Simplex Fiber Optic Connector for 900µm tight-buffered fiber installation.	Black	1	10
FLCDMC5BLY	LC OptiCam® 50/125µm Multimode Duplex Fiber Optic Connector for 900µm tight-buffered fiber installation.	Black	1	10
LC OptiCam® OM1 62.5/125µm Multimode Fiber Optic Connectors				
FLCDMC6E1Y	LC OptiCam® 62.5/125µm Multimode Simplex Fiber Optic Connector for 900µm tight-buffered fiber installation.	Electric Ivory	1	10
FLCDMC6E1Y	LC OptiCam® 62.5/125µm Multimode Duplex Fiber Optic Connector for 900µm tight-buffered fiber installation.	Electric Ivory	1	10
LC OptiCam® OS1/OS2 Singlemode Fiber Optic Connectors				
FLCSSCBUY	LC OptiCam® Singlemode Simplex Fiber Optic Connector for 900µm tight-buffered fiber installation.	Blue	1	10
FLCDSCBUY	LC OptiCam® Singlemode Duplex Fiber Optic Connector for 900µm tight-buffered fiber installation.	Blue	1	10
OptiCam® 1.6/2.0mm Cable Retention Boot Assemblies				
FMCBT2AQ-X	OptiCam® 10Gig™ OM3 1.6/2.0mm Cable Retention Boot.	Aqua	10	100
FMCBT2BL-X	OptiCam® OM2 Multimode 1.6/2.0mm Cable Retention Boot.	Black	10	100
FMCBT2EI-X	OptiCam® OM1 Multimode 1.6/2.0mm Cable Retention Boot.	Electric Ivory	10	100
FSCBT2BU-X	OptiCam® OS1/OS2 Singlemode 1.6/2.0mm Cable Retention Boot.	Blue	10	100
OptiCam® 3.0mm Cable Retention Boot Assemblies				
FMCBT3AQ-X	OptiCam® 10Gig™ OM3 3.0mm Cable Retention Boot.	Aqua	10	100
FMCBT3BL-X	OptiCam® OM2 Multimode 3.0mm Cable Retention Boot.	Black	10	100
FMCBT3EI-X	OptiCam® OM1 Multimode 3.0mm Cable Retention Boot.	Electric Ivory	10	100
FSCBT3BU-X	OptiCam® OS1/OS2 Singlemode 3.0mm Cable Retention Boot.	Blue	10	100
LC OptiCam® Duplex Clip				
FLCCLIPBL-L	LC OptiCam® Duplex Clip for duplexing two simplex LC OptiCam® Multimode or Singlemode Connectors.	Black	50	—

*Simplex connectors are available in 100 count bulk packages by adding -C to the part number.



Keyed LC OptiCam® Fiber Optic Connectors – Pre-Polished Cam Termination

- Exceed TIA/EIA-568-B.3 requirements
- Insertion loss: 0.3dB average (multimode and singlemode)
- Return loss: >26dB (10Gig™ multimode), >20dB (multimode), >50dB (singlemode)
- Include color-specific keys with positive and negative keying features to visually and mechanically distinguish connections to prevent unauthorized mating with unlike keyed or non-keyed adapters
- Part of a complete Keyed LC System that includes Opti-Core® Patch Cords and Pigtails, OptiCam® Pre-Polished Cam Connectors, Opticom® Fiber Adapter Panels (FAPs), and Mini-Com® Adapter Modules
- Translucent housing assembly is laser marked to identify fiber stub fiber type (9µm, 62.5, 50 or 50X)
- Spring-loaded “Senior” rear pivot latch LC connector
- Quick installation; provide field termination in less than half the time of field polish connectors
- Patented re-termination capability provides yield rates approaching 100%
- Factory pre-polished fiber endface eliminates time-consuming field polishing to reduce installation costs, labor, scrap, and the number of tools required
- Cam activated fiber and buffer clamp mechanisms provide superior fiber and buffer retention – less sensitivity to fiber tensile loading
- OptiCam® Termination Tool simplifies tooling and termination, and virtually eliminates operator error by providing visual indication of proper termination after the cam step has been completed
- Cable retention boot assemblies consistently provide higher than industry standard cable retention
- Non-optical disconnect maintains data transmission under tensile loads for jacketed cable
- Fiber cable size: accept 900µm tight-buffered fiber with included boot(s); accept 1.6mm – 2.0mm and 3.0mm jacketed cable with available OptiCam® Cable Retention Boot Assemblies (ten per package)
- For 250µm coated fiber termination, use 250 micron fiber build-up tube kit or fan-out kits on pages C.27 – C.28
- Ferrule type: 1.25mm zirconia ceramic (highest durability for repeated matings)
- Use OptiCam® Termination Kit (FCAMKIT) on page C.101



FLCSMC5ABL



FLCSMC5BRD



FLCSMC5CGR



FLCSMC5DYL



FLCSMC5EOR



FLCSMC5FDB

Part Number	Part Description	Key Type and Color	Std. Pkg. Qty.	Std. Ctn. Qty.
Keyed LC OptiCam® 10Gig™ OM3/OM4 50/125µm Multimode Simplex Fiber Optic Connectors*				
FLCSMCXABL	LC (keyed A – black) OptiCam® 10Gig™ 50/125µm Multimode Simplex Fiber Optic Connector for 900µm tight-buffered fiber installation.	Keyed A – Black	1	10
FLCSMCXBRD	LC (keyed B – red) OptiCam® 10Gig™ 50/125µm Multimode Simplex Fiber Optic Connector for 900µm tight-buffered fiber installation.	Keyed B – Red	1	10
FLCSMCXCGR	LC (keyed C – green) OptiCam® 10Gig™ 50/125µm Multimode Simplex Fiber Optic Connector for 900µm tight-buffered fiber installation.	Keyed C – Green	1	10
FLCSMCXDYL	LC (keyed D – yellow) OptiCam® 10Gig™ 50/125µm Multimode Simplex Fiber Optic Connector for 900µm tight-buffered fiber installation.	Keyed D – Yellow	1	10
FLCSMCXEOR	LC (keyed E – orange) OptiCam® 10Gig™ 50/125µm Multimode Simplex Fiber Optic Connector for 900µm tight-buffered fiber installation.	Keyed E – Orange	1	10
FLCSMCXFDB	LC (keyed F – dark blue) OptiCam® 10Gig™ 50/125µm Multimode Simplex Fiber Optic Connector for 900µm tight-buffered fiber installation.	Keyed F – Dark Blue	1	10
Keyed LC OptiCam® OM2 50/125µm Multimode Simplex Fiber Optic Connectors*				
FLCSMC5ABL	LC (keyed A – black) OptiCam® 50/125µm Multimode Simplex Fiber Optic Connector for 900µm tight-buffered fiber installation.	Keyed A – Black	1	10
FLCSMC5BRD	LC (keyed B – red) OptiCam® 50/125µm Multimode Simplex Fiber Optic Connector for 900µm tight-buffered fiber installation.	Keyed B – Red	1	10
FLCSMC5CGR	LC (keyed C – green) OptiCam® 50/125µm Multimode Simplex Fiber Optic Connector for 900µm tight-buffered fiber installation.	Keyed C – Green	1	10
FLCSMC5DYL	LC (keyed D – yellow) OptiCam® 50/125µm Multimode Simplex Fiber Optic Connector for 900µm tight-buffered fiber installation.	Keyed D – Yellow	1	10
FLCSMC5EOR	LC (keyed E – orange) OptiCam® 50/125µm Multimode Simplex Fiber Optic Connector for 900µm tight-buffered fiber installation.	Keyed E – Orange	1	10
FLCSMC5FDB	LC (keyed F – dark blue) OptiCam® 50/125µm Multimode Simplex Fiber Optic Connector for 900µm tight-buffered fiber installation.	Keyed F – Dark Blue	1	10

*To order duplex connectors, replace the first S in the part number (FLCSMCXABL) with a D (FLCDSCABL).
 The Keyed LC Fiber Optic System is now offering 18 colors to ensure network physical layer security with color-specific keyed connectivity.
 For complete keyed solutions, please reference www.panduit.com.

Keyed LC OptiCam® Fiber Optic Connectors – Pre-Polished Cam Termination (continued)



FMCBT3BL-X



FLCCLIPBL-L

Part Number	Part Description	Key Type and Color	Std. Pkg. Qty.	Std. Ctn. Qty.
Keyed LC OptiCam® OM1 62.5/125µm Multimode Simplex Fiber Optic Connectors*				
FLCSCM6ABL	LC (keyed A – black) OptiCam® 62.5/125µm Multimode Simplex Fiber Optic Connector for 900µm tight-buffered fiber installation.	Keyed A – Black	1	10
FLCSCM6BRD	LC (keyed B – red) OptiCam® 62.5/125µm Multimode Simplex Fiber Optic Connector for 900µm tight-buffered fiber installation.	Keyed B – Red	1	10
FLCSCM6CGR	LC (keyed C – green) OptiCam® 62.5/125µm Multimode Simplex Fiber Optic Connector for 900µm tight-buffered fiber installation.	Keyed C – Green	1	10
FLCSCM6DYL	LC (keyed D – yellow) OptiCam® 62.5/125µm Multimode Simplex Fiber Optic Connector for 900µm tight-buffered fiber installation.	Keyed D – Yellow	1	10
FLCSCM6EOR	LC (keyed E – orange) OptiCam® 62.5/125µm Multimode Simplex Fiber Optic Connector for 900µm tight-buffered fiber installation.	Keyed E – Orange	1	10
FLCSCM6FDB	LC (keyed F – dark blue) OptiCam® 62.5/125µm Multimode Simplex Fiber Optic Connector for 900µm tight-buffered fiber installation.	Keyed F – Dark Blue	1	10
Keyed LC OptiCam® OS1/OS2 Singlemode Simplex Fiber Optic Connectors*				
FLCSSCABL	LC (keyed A – black) OptiCam® Singlemode Simplex Fiber Optic Connector for 900µm tight-buffered fiber installation.	Keyed A – Black	1	10
FLCSSCBRD	LC (keyed B – red) OptiCam® Singlemode Simplex Fiber Optic Connector for 900µm tight-buffered fiber installation.	Keyed B – Red	1	10
FLCSSCCGR	LC (keyed C – green) OptiCam® Singlemode Simplex Fiber Optic Connector for 900µm tight-buffered fiber installation.	Keyed C – Green	1	10
FLCSSCDYL	LC (keyed D – yellow) OptiCam® Singlemode Simplex Fiber Optic Connector for 900µm tight-buffered fiber installation.	Keyed D – Yellow	1	10
FLCSSCEOR	LC (keyed E – orange) OptiCam® Singlemode Simplex Fiber Optic Connector for 900µm tight-buffered fiber installation.	Keyed E – Orange	1	10
FLCSSCFDB	LC (keyed F – dark blue) OptiCam® Singlemode Simplex Fiber Optic Connector for 900µm tight-buffered fiber installation.	Keyed F – Dark Blue	1	10
OptiCam® 1.6/2.0mm Cable Retention Boot Assemblies				
FMCBT2BL-X	OptiCam® 1.6/2.0mm Cable Retention Boot.	Black	10	100
OptiCam® 3.0mm Cable Retention Boot Assemblies				
FMCBT3BL-X	OptiCam® 3.0mm Cable Retention Boot.	Black	10	100
LC OptiCam® Duplex Clip				
FLCCLIPBL-L	LC OptiCam® Duplex Clip for duplexing two simplex LC OptiCam® Multimode or Singlemode Connectors.	Black	50	—

*To order duplex connectors, replace the first S in the part number (FLCSSCABL) with a D (FLCDSCABL).

The Keyed LC Fiber Optic System is now offering 18 colors to ensure network physical layer security with color-specific keyed connectivity. For complete keyed solutions, please reference www.panduit.com.

A.
System
Overview

B.
Copper
Systems

C.
Fiber
Optic
Systems

D.
Power
over
Ethernet

E.
Zone
Cabling

F.
Wireless

G.
Outlets

H.
Media
Distribution

I.
Physical
Infrastructure
Management

J.
Overhead &
Underfloor
Routing

K.
Surface
Raceway

L.
Cabinets,
Racks &
Cable
Management

M.
Grounding &
Bonding

N.
Industrial

O.
Labeling &
Identification

P.
Cable
Management
Accessories

Q.
Index



SC OptiCam® Fiber Optic Connectors – Pre-Polished Cam Termination

- TIA/EIA-604 FOCIS-3 compliant connectors
- Exceed TIA/EIA-568-B.3 requirements
- Connector backbone and boot colors follow TIA/EIA-568-C.3 suggested color identification scheme
- Insertion loss: 0.3dB average (multimode and singlemode)
- Return loss: >26dB (10Gig™ multimode), >20dB (singlemode)
- Quick installation; provide field termination in less than half the time of field polish connectors
- Patented re-termination capability provides yield rates approaching 100%
- Factory pre-polished fiber endface eliminates time-consuming field polishing to reduce installation costs, labor, scrap and the number of tools required
- Cam activated fiber and buffer clamp mechanisms provide superior fiber and buffer retention – less sensitivity to fiber tensile loading
- OptiCam® Termination Tool simplifies tooling and termination, and virtually eliminates operator error by providing visual indication of proper termination after the cam step has been completed
- Cable retention boot assemblies consistently provide higher than industry standard cable retention
- Non-optical disconnect maintains data transmission under tensile loads for jacketed cable
- Fiber cable size: accept 900µm tight-buffered fiber with included boot(s); accept 1.6mm – 2.0mm and 3.0mm jacketed cable with available OptiCam® Cable Retention Boot Assemblies (ten per package)– ten per package
- For 250µm coated fiber termination, use 250 micron fiber build-up tube kit or fan-out kits on pages C.27 – C.28
- Ferrule type: 2.5mm zirconia ceramic (highest durability for repeated matings) or composite to meet a variety of application requirements
- Use OptiCam® Termination Kit (FCAMKIT) on page C.101



FSCDMCXAQ



FSCDMC5BL



FSCSCBU



FMCBT3BL-X



FSCCLIP-L

Part Number	Part Description	Color	Std. Pkg. Qty.*	Std. Ctn. Qty.
SC OptiCam® 10Gig™ OM3/OM4 50/125µm Multimode Fiber Optic Connectors				
FSCMCXAQ	SC OptiCam® 10Gig™ 50/125µm OM3/OM4 Multimode Simplex Fiber Optic Connector for 900µm tight-buffered fiber installation.	Aqua	1	10
FSCDMCXAQ	SC OptiCam® 10Gig™ 50/125µm OM3/OM4 Multimode Duplex Fiber Optic Connector for 900µm tight-buffered fiber installation.	Aqua	1	10
SC OptiCam® OM2 50/125µm Multimode Fiber Optic Connectors				
FSCMC5BL	SC OptiCam® 50/125µm Multimode Simplex Fiber Optic Connector for 900µm tight-buffered fiber installation.	Black	1	10
FSCDMC5BL	SC OptiCam® 50/125µm Multimode Duplex Fiber Optic Connector for 900µm tight-buffered fiber installation.	Black	1	10
SC OptiCam® OM1 62.5/125µm Multimode Fiber Optic Connectors				
FSCMC6EI	SC OptiCam® 62.5/125µm Multimode Simplex Fiber Optic Connector for 900µm tight-buffered fiber installation.	Electric Ivory	1	10
FSCDMC6EI	SC OptiCam® 62.5/125µm Multimode Duplex Fiber Optic Connector for 900µm tight-buffered fiber installation.	Electric Ivory	1	10
SC OptiCam® OS1/OS2 Singlemode Fiber Optic Connectors				
FSCSCBU	SC OptiCam® Singlemode Simplex Fiber Optic Connector for 900µm tight-buffered fiber installation.	Blue	1	10
OptiCam® 1.6/2.0mm Cable Retention Boot Assemblies				
FMCBT2AQ-X	OptiCam® 10Gig™ OM3/OM4 1.6/2.0mm Cable Retention Boot.	Aqua	10	100
FMCBT2BL-X	OptiCam® OM2 Multimode 1.6/2.0mm Cable Retention Boot.	Black	10	100
FMCBT2EI-X	OptiCam® OM1 Multimode 1.6/2.0mm Cable Retention Boot.	Electric Ivory	10	100
FSCBT2BU-X	OptiCam® OS1/OS2 Singlemode 1.6/2.0mm Cable Retention Boot.	Blue	10	100
OptiCam® 3.0mm Cable Retention Boot Assemblies				
FMCBT3AQ-X	OptiCam® 10Gig™ OM3/OM4 3.0mm Cable Retention Boot.	Aqua	10	100
FMCBT3BL-X	OptiCam® OM2 Multimode 3.0mm Cable Retention Boot.	Black	10	100
FMCBT3EI-X	OptiCam® OM1 Multimode 3.0mm Cable Retention Boot.	Electric Ivory	10	100
FSCBT3BU-X	OptiCam® OS1/OS2 Singlemode 3.0mm Cable Retention Boot.	Blue	10	100
SC Duplex Clip				
FSCCLIP-L	SC duplex clip for duplexing two simplex Panduit SC multimode or singlemode connectors.	Black	50	—

*Simplex connectors are available in 100 count bulk packages by adding -C to the part number.



ST OptiCam® Fiber Optic Connectors – Pre-Polished Cam Termination

- TIA/EIA-604 FOCIS-2 compliant connectors
- Exceed TIA/EIA-568-B.3 requirements
- Connector backbone and boot colors follow TIA/EIA-568-C.3 suggested color identification scheme
- Insertion loss: 0.3dB average (multimode and singlemode)
- Return loss: >26dB (10Gig™ multimode), >20dB (multimode), >50dB (singlemode)
- Quick installation; provide field termination in less than half the time of field polish connectors
- Patented re-termination capability provides yield rates approaching 100%
- Factory pre-polished fiber endface eliminates time-consuming field polishing to reduce installation costs, labor, scrap and the number of tools required
- Cam activated fiber and buffer clamp mechanisms provide superior fiber and buffer retention – less sensitivity to fiber tensile loading

- OptiCam® Termination Tool simplifies tooling and termination, and virtually eliminates operator error by providing visual indication of proper termination after the cam step has been completed
- Cable retention boot assemblies consistently provide higher than industry standard cable retention
- Fiber cable size: accept 900µm tight-buffered fiber with included boot(s); accept 1.6mm – 2.0mm and 3.0mm jacketed cable with available OptiCam® Cable Retention Boot Assemblies (ten per package)
- For 250µm coated fiber termination, use 250 micron fiber build-up tube kit or fan-out kits on pages C.27 – C.28
- Ferrule type: 2.5mm zirconia ceramic (highest durability for repeated matings) or composite to meet a variety of application requirements
- Use OptiCam® Termination Kit (FCAMKIT) on page C.101



FSTMCAQ



FSTMC5BL



FSTSCBU



FSCBT2BU-X

Part Number	Part Description	Color	Std. Pkg. Qty.*	Std. Ctn. Qty.
ST OptiCam® 10Gig™ OM3/OM4 50/125µm Multimode Fiber Optic Connectors				
FSTMCAQ	ST OptiCam® 10Gig™ 50/125µm OM3/OM4 Multimode Simplex Fiber Optic Connector for 900µm tight-buffered fiber installation.	Aqua	1	10
ST OptiCam® OM2 50/125µm Multimode Fiber Optic Connectors				
FSTMC5BL	ST OptiCam® 50/125µm Multimode Simplex Fiber Optic Connector for 900µm tight-buffered fiber installation.	Black	1	10
ST OptiCam® OM1 62.5/125µm Multimode Fiber Optic Connectors				
FSTMC6EI	ST OptiCam® 62.5/125µm Multimode Simplex Fiber Optic Connector for 900µm tight-buffered fiber installation.	Electric Ivory	1	10
ST OptiCam® OS1/OS2 Singlemode Fiber Optic Connectors				
FSTSCBU	ST OptiCam® Singlemode Simplex Fiber Optic Connector for 900µm tight-buffered fiber installation.	Blue	1	10
OptiCam® 1.6/2.0mm Cable Retention Boot Assemblies				
FMCBT2AQ-X	OptiCam® 10Gig™ OM3/OM4 1.6/2.0mm Cable Retention Boot.	Aqua	10	100
FMCBT2BL-X	OptiCam® OM2 Multimode 1.6/2.0mm Cable Retention Boot.	Black	10	100
FMCBT2EI-X	OptiCam® OM1 Multimode 1.6/2.0mm Cable Retention Boot.	Electric Ivory	10	100
FSCBT2BU-X	OptiCam® OS1/OS2 Singlemode 1.6/2.0mm Cable Retention Boot.	Blue	10	100
OptiCam® 3.0mm Cable Retention Boot Assemblies				
FMCBT3AQ-X	OptiCam® 10Gig™ OM3/OM4 3.0mm Cable Retention Boot.	Aqua	10	100
FMCBT3BL-X	OptiCam® OM2 Multimode 3.0mm Cable Retention Boot.	Black	10	100
FMCBT3EI-X	OptiCam® OM1 Multimode 3.0mm Cable Retention Boot.	Electric Ivory	10	100
FSCBT3BU-X	OptiCam® OS1/OS2 Singlemode 3.0mm Cable Retention Boot.	Blue	10	100

*Simplex connectors are available in 100 count bulk packages by adding -C to the part number.

LC Fiber Optic Connectors – Field Polish Termination

- TIA/EIA-604 FOCIS-10 compatible connectors
- Exceed TIA/EIA-568-B.3 requirements
- Connector housing and boot colors follow TIA/EIA-568-C.3 suggested color identification scheme
- Insertion loss: 0.10dB average (multimode and singlemode)
- Return loss: >20dB (multimode), >40dB (singlemode)
- Non-optical disconnect maintains data transmission under tensile loads for jacketed cable
- Each simplex connector includes connector body/ferrule assembly, crimp sleeve, one boot for 900µm buffered fiber and one boot for 1.6mm – 2.0mm jacketed cable and one dust cap; 3.0mm jacketed cable connectors are also available separately
- Each duplex connector includes two connector body/ferrule assemblies, two crimp sleeves, two boots for 1.6mm – 2.0mm or 3.0mm jacketed cable or two boots for 900µm buffered fiber, two dust caps and one duplex clip
- LC duplex clip available separately for duplexing two simplex Panduit LC Connectors
- Fiber cable type: tight-buffered recommended
- Fiber cable size: accept 1.6mm – 2.0mm or 3.0mm jacketed cable, or 900µm buffered fiber (noted in part description)
- For 250µm coated fiber termination, use 250 micron fiber build-up tube kit or fan-out kits on pages C.27 – C.28
- Ferrule type: 1.25mm zirconia ceramic (highest durability for repeated matings)
- Field polish termination – Panduit recommends anaerobic adhesive on pages C.103, C.104
- Use field polish termination kit (FIELDKIT) on pages C.103, C.104

**FLCSMBLY****FLCDMBLY****FLCDM3.0EI**

Part Number	Part Description	Color	Std. Pkg. Qty.	Std. Ctn. Qty.
LC OM4/OM3/OM2 Multimode Fiber Optic Connectors				
FLCSMBLY	LC multimode simplex fiber optic connector for 1.6mm – 2.0mm jacketed cable or 900µm buffered fiber installation.	Black	1	10
FLCSM3.0BL	LC multimode simplex fiber optic connector for 3.0mm jacketed cable installation.	Black	1	10
FLCDBMBLY	LC multimode duplex fiber optic connector for 1.6mm – 2.0mm jacketed cable installation.	Black	1	10
FLCDM900BLY	LC multimode duplex fiber optic connector for 900µm buffered fiber installation.	Black	1	10
FLCDM3.0BL	LC multimode duplex fiber optic connector for 3.0mm jacketed cable installation.	Black	1	10
LC OM1 Multimode Fiber Optic Connectors				
FLCSMEIY	LC multimode simplex fiber optic connector for 1.6mm – 2.0mm jacketed cable or 900µm buffered fiber installation.	Electric Ivory	1	10
FLCSM3.0EI	LC multimode simplex fiber optic connector for 3.0mm jacketed cable installation.	Electric Ivory	1	10
FLCDMEIY	LC multimode duplex fiber optic connector for 1.6mm – 2.0mm jacketed cable installation.	Electric Ivory	1	10
FLCDM900EIY	LC multimode duplex fiber optic connector for 900µm buffered fiber installation.	Electric Ivory	1	10
FLCDM3.0EI	LC multimode duplex fiber optic connector for 3.0mm jacketed cable installation.	Electric Ivory	1	10

LC Fiber Optic Connectors – Field Polish Termination (continued)

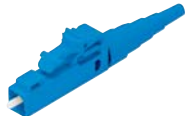

FLCSSBUY



FLCDSBUY



FLCDS3.0BU



FLCCLIP-L

Part Number	Part Description	Color	Std. Pkg. Qty.	Std. Ctn. Qty.
LC OS1/OS2 Singlemode Fiber Optic Connectors				
FLCSSBUY	LC singlemode simplex fiber optic connector for 1.6mm – 2.0mm jacketed cable or 900µm buffered fiber installation.	Blue	1	10
FLCSS3.0BU	LC singlemode simplex fiber optic connector for 3.0mm jacketed cable installation.	Blue	1	10
FLCDSBUY	LC singlemode duplex fiber optic connector for 1.6mm – 2.0mm jacketed cable installation.	Blue	1	10
FLCDS900BUY	LC singlemode duplex fiber optic connector for 900µm buffered fiber installation.	Blue	1	10
FLCDS3.0BU	LC singlemode duplex fiber optic connector for 3.0mm jacketed cable installation.	Blue	1	10
LC 10Gig™ OM3/OM4 Field Polish Boots				
FLCBT900AQ-X	LC 10Gig™ OM3/OM4 Field Polish Boot for 900µm buffered fiber.	Aqua	10	100
FLCBT2AQ-X	LC 10Gig™ OM3/OM4 Field Polish Boot for 1.6/2.0mm jacketed cable.	Aqua	10	100
FLCBT3AQ-X	LC 10Gig™ OM3/OM4 Field Polish Boot for 3.0mm jacketed cable.	Aqua	10	100
LC Duplex Clip				
FLCCLIP-L	LC duplex clip for duplexing two simplex Panduit LC field polish multimode or singlemode connectors.	White	50	—

SC Fiber Optic Connectors – Field Polish Termination

- TIA/EIA-604 FOCIS-3 compliant connectors
- Exceed TIA/EIA-568-B.3 requirements
- Connector outer housing and boot colors follow TIA/EIA-568-C.3 suggested color identification scheme
- Insertion loss: 0.10dB average (multimode), 0.15dB average (singlemode)
- Return loss: >20dB (multimode), >40dB (singlemode)
- Non-optical disconnect maintains data transmission under tensile loads for jacketed cable
- Free floating housing ensures complete latching even when inserted by the boot, beneficial in high density spacing applications
- Pre-assembled inner housing simplifies assembly
- Each simplex connector includes inner housing assembly, outer housing, crimp sleeve, one boot for 900µm buffered fiber, one boot for 3mm jacketed cable, and one dust cap
- Each duplex connector includes two inner housing assemblies, two outer housings, two crimp sleeves, two boots for 3mm jacketed cable, two dust caps, and one duplex clip
- SC duplex clip available separately for duplexing two simplex Panduit SC Connectors
- Fiber cable type: tight-buffered recommended
- Fiber cable size: accept 900µm buffered fiber, 3mm jacketed cable or 1.6mm – 2.0mm jacketed cable (noted in part description)
- For 250µm coated fiber termination, use 250 micron fiber build-up tube kit or fan-out kits on pages C.27 – C.28
- Ferrule type: 2.5mm zirconia ceramic (highest durability for repeated matings)
- Field polish termination – Panduit recommends anaerobic adhesive on pages C.103, C.104
- Use field polish termination kit (FIELDKIT) on pages C.103, C.104



FSCM5BL



FSCMBL



FSCMRD



FSCDM



FSCSBU



FSCCLIP-L



Part Number	Part Description	Color	Std. Pkg. Qty.	Std. Ctn. Qty.
-------------	------------------	-------	----------------	----------------

SC OM3/OM2 Multimode Fiber Optic Connectors

FSCM5BL	SC multimode simplex fiber optic connector for 3.0mm jacketed cable or 900µm buffered fiber installation.	Black	1	10
FSCM2.05BL	SC multimode simplex fiber optic connector for 1.6mm – 2.0mm jacketed cable or 900µm buffered fiber installation.	Black	1	10
FSCDM5BL	SC multimode duplex fiber optic connector for 3.0mm jacketed cable installation.	Black	1	10

SC OM1 Multimode Fiber Optic Connectors

FSCMBL	SC multimode simplex fiber optic connector for 3.0mm jacketed cable or 900µm buffered fiber installation.	Black	1	10
FSCMRD	SC multimode simplex fiber optic connector for 3.0mm jacketed cable or 900µm buffered fiber installation.	Red	1	10
FSCM2.0BL	SC multimode simplex fiber optic connector for 1.6mm – 2.0mm jacketed cable or 900µm buffered fiber installation.	Black	1	10
FSCM2.0RD	SC multimode simplex fiber optic connector for 1.6mm – 2.0mm jacketed cable or 900µm buffered fiber installation.	Red	1	10
FSCDM	SC multimode duplex fiber optic connector for 3.0mm jacketed cable installation.	Red & Black	1	10

SC OS1/OS2 Singlemode Fiber Optic Connectors

FSCSBU	SC singlemode simplex fiber optic connector for 3.0mm jacketed cable or 900µm buffered fiber installation.	Blue	1	10
FSCS2.0BU	SC singlemode simplex fiber optic connector for 1.6mm – 2.0mm jacketed cable or 900µm buffered fiber installation.	Blue	1	10

SC 900µm Field Polish Boots

FSCBT900AQ-X	SC 10Gig™ OM3 Field Polish Boot for 900µm buffered fiber.	Aqua	10	100
FSCBT900EI-X	SC OM1 multimode field polish boot for 900µm buffered fiber.	Electric Ivory	10	100

SC 1.6/2.0mm Field Polish Boots

FSCBT2BU-X	OptiCam® OS1/OS2 Singlemode 1.6/2.0mm Cable Retention Boot.	Blue	10	100
-------------------	---	------	----	-----

SC 3.0mm Field Polish Boots

FSCBT3AQ-X	SC 10Gig™ OM3 Field Polish Boot for 3.0mm jacketed cable.	Aqua	10	100
FSCBT3EI-X	SC OM1 multimode field polish boot for 3.0mm jacketed cable.	Electric Ivory	10	100

SC Duplex Clip

FSCCLIP-L	SC duplex clip for duplexing two simplex Panduit SC multimode or singlemode connectors.	Black	50	—
------------------	---	-------	----	---

ST Fiber Optic Connectors – Field Polish Termination

- TIA/EIA-604 FOCIS-2 compatible connectors
- Exceed TIA/EIA-568-B.3 requirements
- Insertion loss: 0.15dB average (multimode), 0.20dB average (singlemode)
- Return loss: >20dB (multimode), >40dB (singlemode)
- Each connector includes metal connector body/ferrule assembly, spring, metal bayonet, crimp sleeve, one boot for 900µm buffered fiber, one boot for 3mm jacketed cable, and one dust cap
- Fiber cable type: tight-buffered recommended
- Fiber cable size: accept 3.0mm jacketed cable or 900µm buffered fiber
- For 250µm coated fiber termination, use 250 micron fiber build-up tube kit or fan-out kits on pages C.27 – C.28
- Ferrule type: 2.5mm zirconia ceramic (highest durability for repeated matings)
- Field polish termination – Panduit recommends anaerobic adhesive on pages C.103, C.104
- Use field polish termination kit (FIELDKIT) on pages C.103, C.104



Part Number	Part Description	Color	Std. Pkg. Qty.	Std. Ctn. Qty.
ST Multimode Fiber Optic Connectors				
FSTMABL	ST multimode simplex fiber optic connector for 3.0mm jacketed cable or 900µm buffered fiber installation.	Black	1	10
FSTMARD		Red	1	10
ST Singlemode Fiber Optic Connector				
FSTSABU	ST singlemode simplex fiber optic connector for 3.0mm jacketed cable or 900µm buffered fiber installation.	Blue	1	10

250 Micron Fiber Build-Up Tube Kit

- Includes 100 build-up tubes and supplemental instructions for terminating Panduit field polish, Opti-Crimp®, or OptiCam® Fiber Optic Connectors onto 250µm coated fiber
- Used with 900µm boots included with connectors and the current fiber optic termination kit



Part Number	Part Description	Std. Pkg. Qty.
F250BT-C	250 micron fiber build-up tube kit; includes 100 build-up tubes and supplemental installation instructions.	100

Furcation Kits

- Used to build up 900µm fiber to 3mm jacketed fiber to strengthen and protect the fiber
- Include furcation tubing with strength members and heat shrink
- Length: 1 meter



FK2BJ

Part Number	Part Description	Std. Pkg. Qty.	Std. Ctn. Qty.
FK2BJ	Build up 900µm fiber to 3mm jacketed fiber; for two fibers.	1	10
FK4BJ	Build up 900µm fiber to 3mm jacketed fiber; for four fibers.	1	10

Fan-Out Kits

- Used to build up 250µm fiber to 900µm loose buffered coating size for connector termination
- Include 900µm hollow tubing and plastic housings
- Include adhesive tape for mounting
- Include TEFLON* powder for easy insertion of fibers
- Length: 1 meter (39.37")



FO12CB

Part Number	Part Description	Std. Pkg. Qty.	Std. Ctn. Qty.
FO6CB	Build up 250µm fiber to 900µm loose buffered coating size; for six fibers.	1	10
FO12CB	Build up 250µm fiber to 900µm loose buffered coating size; for twelve fibers.	1	10

*TEFLON is a registered trademark of E.I. du Pont de Nemours and Company.

LC Sr./Sr. Fiber Optic Adapters

- TIA/EIA-604 FOCIS-10 compatible adapters
- Exceed TIA/EIA-568-B.3 requirements
- Adapter housing colors follow TIA/EIA-568-C.3 suggested color identification scheme
- Sr./Sr. (Senior/Senior) adapters have a FOCIS-10 senior adapter interface at each end
- Accept FOCIS-10 compatible senior LC connectors
- Choice of phosphor bronze or zirconia ceramic split sleeves to fit specific network requirements; zirconia ceramic split sleeves are recommended for OM3/OM4 multimode and OS1/OS2 singlemode applications
- LC simplex and duplex adapters are also available in Opticom[®] Fiber Adapter Panels on page C.39 and in QuickNet[™] Fiber Optic Cassettes on pages C.44 – C.53 to provide a complete LC system solution
- LC duplex adapters are also available in Mini-Com[®] Modules on pages C.32 – C.33



FADSLCZAQ-L



FADSLCBL-L



FADSLCEI-L



FASSLCZBU-L

Part Number	Part Description	Split Sleeve Material	Std. Pkg. Qty.	Std. Ctn. Qty.
LC Sr./Sr. Fiber Optic Adapters – 10Gig[™] OM3/OM4 50/125µm (Aqua)				
FADSLCZAQ-L	LC Sr./Sr. 10Gig [™] SFF Duplex Multimode Fiber Optic Adapter with zirconia ceramic split sleeves.	Zirconia Ceramic	50	100
FADSLCAQ-L	LC Sr./Sr. 10Gig [™] SFF Duplex Multimode Fiber Optic Adapter with phosphor bronze split sleeves.	Phosphor Bronze	50	100
LC Sr./Sr. Fiber Optic Adapters – OM2 50/125µm (Black)				
FADSLCBL-L	LC Sr./Sr. SFF duplex multimode fiber optic adapter with phosphor bronze split sleeves.	Phosphor Bronze	50	100
LC Sr./Sr. Fiber Optic Adapters – OM1 62.5µm (Electric Ivory)				
FADSLCEI-L	LC Sr./Sr. SFF duplex multimode fiber optic adapter with phosphor bronze split sleeves.	Phosphor Bronze	50	100
LC Sr./Sr. Fiber Optic Adapters – OS1/OS2 9/125µm (Blue)				
FASSLCZBU-L	LC Sr./Sr. SFF simplex singlemode fiber optic adapter with zirconia ceramic split sleeve.	Zirconia Ceramic	50	100
FADSLCZBU-L	LC Sr./Sr. SFF duplex singlemode fiber optic adapter with zirconia ceramic split sleeves.	Zirconia Ceramic	50	100

LC Sr./Jr. Fiber Optic Adapters

- TIA/EIA-604 FOCIS-10 compatible adapters
- Exceed TIA/EIA-568-B.3 requirements
- Adapter housing colors follow TIA/EIA-568-C.3 suggested color identification scheme
- Sr./Jr. (Senior/Junior) adapters have a FOCIS-10 senior adapter interface at one end and a FOCIS-10 junior adapter interface at the other end
- Both ends accept FOCIS-10 compatible senior LC connectors
- Junior end also accepts FOCIS-10 compatible junior (fixed ferrule/springless) LC connectors
- Accommodate tighter applications (inside wall); allowing easier access to LC connectors terminated on 900µm buffered fiber
- Choice of phosphor bronze or zirconia ceramic split sleeves to fit specific network requirements; zirconia ceramic split sleeves are recommended for OM3/OM4 multimode and OS1/OS2 singlemode applications
- LC simplex and duplex adapters are also available in Opticom® Fiber Adapter Panels on page C.39 and in QuickNet™ Fiber Optic Cassettes on pages C.44 – C.53 to provide a complete LC system solution
- LC duplex adapters are also available in Mini-Com® Modules on page C.33



FADJLCZAQ-L



FADJLCBL-L



FADJLCBL-L



FASJLCZBU-L

Part Number	Part Description	Split Sleeve Material	Std. Pkg. Qty.	Std. Ctn. Qty.
LC Sr./Jr. Fiber Optic Adapters – 10Gig™ OM3/OM4 50/125µm (Aqua)				
FADJLCZAQ-L	LC Sr./Jr. 10Gig™ SFF Duplex Multimode Fiber Optic Adapter with zirconia ceramic split sleeves.	Zirconia Ceramic	50	100
FADJLCAQ-L	LC Sr./Jr. 10Gig™ SFF Duplex Multimode Fiber Optic Adapter with phosphor bronze split sleeves.	Phosphor Bronze	50	100
LC Sr./Jr. Fiber Optic Adapters – OM2 50/125µm (Black)				
FADJLCBL-L	LC Sr./Jr. SFF duplex multimode fiber optic adapter with phosphor bronze split sleeves.	Phosphor Bronze	50	100
LC Sr./Jr. Fiber Optic Adapters – OM1 62.5/125µm (Electric Ivory)				
FADJLCEI-L	LC Sr./Jr. SFF duplex multimode fiber optic adapter with phosphor bronze split sleeves.	Phosphor Bronze	50	100
LC Sr./Jr. Fiber Optic Adapters – OS1/OS2 9/125µm (Blue)				
FASJLCZBU-L	LC Sr./Jr. SFF simplex singlemode fiber optic adapter with zirconia ceramic split sleeve.	Zirconia Ceramic	50	100
FADJLCZBU-L	LC Sr./Jr. SFF duplex singlemode fiber optic adapter with zirconia ceramic split sleeves.	Zirconia Ceramic	50	100

SC Fiber Optic Adapters

- TIA/EIA-604 FOCIS-3 compliant adapters
- Exceed TIA/EIA-568-B.3 requirements
- Adapter housing colors follow TIA/EIA-568-C.3 suggested color identification scheme
- Integrated retention clip automatically adjusts for FOCIS-3 compliant panel thickness variations, creating a snug fit to reduce rattles; no metal clips to become bent or damaged
- Improved protective cap fully surrounds split sleeve opening
- Choice of phosphor bronze or zirconia ceramic split sleeves to fit specific network requirements; zirconia ceramic split sleeves are recommended for OM3/OM4 multimode and OS1/OS2 singlemode applications
- Short flange design for improved modularity and higher density usage
- Q.C. number and split sleeve material laser marked on every adapter assures 100% traceability and quick and easy identification of split sleeve material
- SC simplex and duplex adapters are also available in Opticom® Fiber Adapter Panels on pages C.41 – C.42 and in QuickNet™ Fiber Optic Cassettes on pages C.44 – C.45 and C.47 – C.48 to provide a complete SC system solution
- SC simplex and duplex adapters are also available in Mini-Com® Modules on page C.35



FADSCZAQ-L



FADSCBL-L



FADSCEI-L



FASSCZBU-L



FASSCZAG-L

Part Number	Part Description	Split Sleeve Material	Std. Pkg. Qty.	Std. Ctn. Qty.
SC Fiber Optic Adapters – 10Gig™ OM3/OM4 50/125µm (Aqua)				
FASSCZAQ-L	SC 10Gig™ Simplex Multimode Fiber Optic Adapter with zirconia ceramic split sleeve.	Zirconia Ceramic	50	100
FASSCAQ-L	SC 10Gig™ Simplex Multimode Fiber Optic Adapter with phosphor bronze split sleeve.	Phosphor Bronze	50	100
FADSCZAQ-L	SC 10Gig™ Duplex Multimode Fiber Optic Adapter with zirconia ceramic split sleeves.	Zirconia Ceramic	50	100
FADSCAQ-L	SC 10Gig™ Duplex Multimode Fiber Optic Adapter with phosphor bronze split sleeves.	Phosphor Bronze	50	100
SC Fiber Optic Adapters – OM2 50/125µm (Black)				
FASSCBL-L	SC simplex multimode fiber optic adapter with phosphor bronze split sleeve.	Phosphor Bronze	50	100
FADSCBL-L	SC duplex multimode fiber optic adapter with phosphor bronze split sleeves.	Phosphor Bronze	50	100
SC Fiber Optic Adapters – OM1 62.5/125µm (Electric Ivory)				
FASSCEI-L	SC simplex multimode fiber optic adapter with phosphor bronze split sleeve.	Phosphor Bronze	50	100
FADSCEI-L	SC duplex multimode fiber optic adapter with phosphor bronze split sleeves.	Phosphor Bronze	50	100
SC Fiber Optic Adapters – OS1/OS2 9/125µm (Blue)				
FASSCZBU-L	SC simplex singlemode fiber optic adapter with zirconia ceramic split sleeve.	Zirconia Ceramic	50	100
FASSCBL-L	SC simplex fiber optic adapter with phosphor bronze split sleeve.	Phosphor Bronze	50	100
FADSCZBU-L	SC duplex singlemode fiber optic adapter with zirconia ceramic split sleeves.	Zirconia Ceramic	50	100
FADSCBL-L	SC duplex fiber optic adapter with phosphor bronze split sleeves.	Phosphor Bronze	50	100
SC Fiber Optic Adapters – APC OS1/OS2 9/125µm (Green)				
FASSCZAG-L	SC APC simplex singlemode fiber optic adapter with zirconia ceramic split sleeve.	Zirconia Ceramic	50	100
FADSCZAG-L	SC APC duplex singlemode fiber optic adapter with zirconia ceramic split sleeves.	Zirconia Ceramic	50	100

ST Fiber Optic Adapters

- TIA/EIA-604 FOCIS-2 compatible adapters
- Exceed TIA/EIA-568-B.3 requirements
- Choice of phosphor bronze or zirconia ceramic split sleeves to fit specific network requirements; zirconia ceramic split sleeves are recommended for OM3 multimode and OS1/OS2 singlemode applications
- ST simplex adapters are also available in Opticom® Fiber Adapter Panels on page C.43 and in QuickNet™ MTP* Fiber Optic Cassettes on pages C.46 – C.53 to provide a complete ST system solution
- ST simplex adapters are also available in Mini-Com® Modules on page C.36 – C.38



FASSTZ-L

Part Number	Part Description	Split Sleeve Material	Std. Pkg. Qty.	Std. Ctn. Qty.
FASSTZ-L	ST singlemode fiber optic adapter with zirconia ceramic sleeve.	Zirconia Ceramic	50	100
FASST-L	ST multimode fiber optic adapter with phosphor bronze split sleeve.	Phosphor Bronze	50	100

*MTP is a registered trademark of US Conec Ltd.

MPO Mini-Com® Fiber Optic Adapter Module



- TIA/EIA-604 FOCIS-5 compliant adapter
- Exceeds TIA/EIA-568-B.3 requirements
- Compatible with Mini-Com® products for complete modularity
- Designed for multimode or singlemode MPO connectors, patch cords, or cable assemblies
- Mini-Com® MPO Adapters are also available in fiber adapter panels to provide a complete MPO solution



Part Number	Part Description	No. of Module Spaces	Module Color	Std. Pkg. Qty.	Std. Ctn. Qty.
CMMPOBLBL	Module supplied with one MPO fiber optic adapter.	2	Black	1	10

For MPO connector cleaning tools, see page C.105.

LC Sr./Sr. Mini-Com[®] Fiber Optic Adapter Modules

- TIA/EIA-604 FOCIS-10 compatible adapters
- Exceed TIA/EIA-568-B.3 requirements
- Adapter housing colors follow TIA/EIA-568-C.3 suggested color identification scheme
- Small form factor (SFF) duplex adapter design fits into single module space
- Compatible with Mini-Com[®] products for complete modularity
- Provide a FOCIS-10 senior adapter interface at each end
- Accept FOCIS-10 compatible senior LC connectors
- Choice of phosphor bronze or zirconia ceramic split sleeves to fit specific network requirements; zirconia ceramic split sleeves are recommended for OM3/OM4 multimode and OS1/OS2 singlemode applications
- Every adapter is laser marked with Q.C. number to assure 100% traceability
- LC simplex and duplex adapters are also available separately on pages C.28 – C.29 and in patch panels or fiber adapter panels to provide a complete LC system solution

**CMDSAQLCZ****CMDSBLLC****CMDSLCEI****CMDSLZBU**

Part Number	Part Description	No. of Module Spaces	Module Color [‡]	Std. Pkg. Qty.	Std. Ctn. Qty.
LC Sr./Sr. Fiber Optic Adapter Modules – 10Gig[™] OM3/OM4 50/125µm (Aqua Adapters)					
CMDSAQLCZBL	Module supplied with one LC Sr./Sr. 10Gig [™] SFF Duplex Multimode Fiber Optic Adapter (AQ) with zirconia ceramic split sleeves.	1	Black	1	10
CMDSAQLCBL	Module supplied with one LC Sr./Sr. 10Gig [™] SFF Duplex Multimode Fiber Optic Adapter (AQ) with phosphor bronze split sleeves.	1	Black	1	10
LC Sr./Sr. Fiber Optic Adapter Modules – OM2 50/125µm (Black Adapters)					
CMDSBLLCBL	Module supplied with one LC Sr./Sr. SFF duplex multimode fiber optic adapter (BL) with phosphor bronze split sleeves.	1	Black	1	10
LC Sr./Sr. Fiber Optic Adapter Modules – OM1 62.5/125µm (Electric Ivory Adapters)					
CMDSLCEI	Module supplied with one LC Sr./Sr. SFF duplex multimode fiber optic adapter (EI) with phosphor bronze split sleeves.	1	Electric Ivory	1	10
LC Sr./Sr. Fiber Optic Adapter Modules – OS1/OS2 9/125µm (Blue Adapters)					
CMDSLZCZBU	Module supplied with one LC Sr./Sr. SFF duplex singlemode fiber optic adapter (BU) with zirconia ceramic split sleeves.	1	Blue	1	10

[‡]For other colors module colors, replace suffix BL (Black), EL (Electric Ivory), or BU (Blue) with EI (Electric Ivory), BU (Blue), BL (Black), IW (Off White) or AW (Arctic White). 10Gig[™] Aqua Adapters are available in black modules only.

LC Sr./Jr. Mini-Com® Fiber Optic Adapter Modules

- TIA/EIA-604 FOCIS-10 compatible adapters
- Exceed TIA/EIA-568-B.3 requirements
- Adapter housing colors follow TIA/EIA-568-C.3 suggested color identification scheme
- Small form factor (SFF) duplex adapter design fits into single module space
- Compatible with Mini-Com® products for complete modularity
- Accept FOCIS-10 compatible senior LC connectors at either end and FOCIS-10 junior LC connectors at the inside end for behind the wall applications
- Choice of phosphor bronze or zirconia ceramic split sleeves to fit specific network requirements; zirconia ceramic split sleeves are recommended for OM3/OM4 multimode and OS1/OS2 singlemode applications
- Every adapter is laser marked with Q.C. number to assure 100% traceability
- LC simplex and duplex adapters are also available separately on pages C.28 – C.29 and in patch panels or fiber adapter panels to provide a complete LC system solution



CMDJAQLCZ



CMDJBLLC



CMDJLCEI



CMDJLCZ

Part Number	Part Description	No. of Module Spaces	Module Color‡	Std. Pkg. Qty.	Std. Ctn. Qty.
LC Sr./Jr. Fiber Optic Adapter Modules – 10Gig™ OM3/OM4 50/125µm (Aqua Adapters)					
CMDJAQLCZBL	Module supplied with one LC Sr./Jr. 10Gig™ SFF Duplex Multimode Fiber Optic Adapter (AQ) with zirconia ceramic split sleeves.	1	Black	1	10
CMDJAQLCBL	Module supplied with one LC Sr./Jr. 10Gig™ SFF Duplex Multimode Fiber Optic Adapter (AQ) with phosphor bronze split sleeves.	1	Black	1	10

LC Sr./Jr. Fiber Optic Adapter Modules – OM2 50/125µm (Black Adapters)					
CMDJBLLCBL	Module supplied with one LC Sr./Jr. SFF duplex multimode fiber optic adapter (BL) with phosphor bronze split sleeves.	1	Black	1	10

LC Sr./Jr. Fiber Optic Adapter Modules – OM1 62.5/125µm (Electric Ivory Adapters)					
CMDJLCEI	Module supplied with one LC Sr./Jr. SFF duplex multimode fiber optic adapter (EI) with phosphor bronze split sleeves.	1	Electric Ivory	1	10

LC Sr./Jr. Fiber Optic Adapter Modules – OS1/OS2 9/125µm (Blue Adapters)					
CMDJLCZBU	Module supplied with one LC Sr./Jr. SFF duplex singlemode fiber optic adapter (BU) with zirconia ceramic split sleeves.	1	Blue	1	10

‡For other colors module colors, replace suffix BL (Black), EL (Electric Ivory), or BU (Blue) with EI (Electric Ivory), BU (Blue), BL (Black), IW (Off White) or AW (Arctic White). 10Gig™ Aqua Adapters are available in black modules only.

 **Keyed LC Mini-Com® Fiber Optic Adapter Modules**

- Exceed TIA/EIA-568-B.3 requirements
- Include color-specific keys with positive and negative keying features to visually and mechanically distinguish connections to prevent unauthorized mating with unlike keyed or non-keyed connectors or patch cords
- Part of a complete keyed LC system that includes Opti-Core® Patch Cords and Pigtails, OptiCam® Pre-Polished Cam Connectors, Opticom® Fiber Adapter Panels (FAPs), and Mini-Com® Adapter Modules
- Small form factor (SFF) keyed LC duplex adapter design fits into single module space
- Compatible with Mini-Com® products for complete modularity
- Provide a keyed senior adapter interface at each end for keyed LC connectivity
- Include zirconia ceramic split sleeves for superior performance and reliability
- Every adapter is laser marked with Q.C. number to assure 100% traceability
- Keyed LC adapters are also available in Keyed LC QuickNet™ Fiber Optic Cassettes on pages C.49 – C.53, or Keyed LC Opticom® Fiber Adapter Panels (FAPs) on page C.40, to provide a complete keyed LC system solution



Part Number	Part Description	No. of Module Spaces	Key Type and Color	Module Color‡	Std. Pkg. Qty.	Std. Ctn. Qty.
CMDABLLCZIW	Module supplied with one LC (keyed A – black) Sr./Sr. SFF duplex fiber optic adapter with zirconia ceramic split sleeves.	1	Keyed A – Black	Off White	1	10
CMDBRDLCZIW	Module supplied with one LC (keyed B – red) Sr./Sr. SFF duplex fiber optic adapter with zirconia ceramic split sleeves.	1	Keyed B – Red	Off White	1	10
CMDCGRLCZIW	Module supplied with one LC (keyed C – green) Sr./Sr. SFF duplex fiber optic adapter with zirconia ceramic split sleeves.	1	Keyed C – Green	Off White	1	10
CMDDYLLCZIW	Module supplied with one LC (keyed D – yellow) Sr./Sr. SFF duplex fiber optic adapter with zirconia ceramic split sleeves.	1	Keyed D – Yellow	Off White	1	10
CMDEORLCZIW	Module supplied with one LC (keyed E – orange) Sr./Sr. SFF duplex fiber optic adapter with zirconia ceramic split sleeves.	1	Keyed E – Orange	Off White	1	10
CMDFDBLCZIW	Module supplied with one LC (keyed F – dark blue) Sr./Sr. SFF duplex fiber optic adapter with zirconia ceramic split sleeves.	1	Keyed F – Dark Blue	Off White	1	10

‡For other colors replace suffix IW (Off White) with AW (Arctic White), BL (Black), BU (Blue) or EI (Electric Ivory).
The Keyed LC Fiber Optic System is now offering 18 colors to ensure network physical layer security with color-specific keyed connectivity.

SC Mini-Com® Fiber Optic Adapter Modules

- TIA/EIA-604 FOCIS-3 compliant adapters
- Exceed TIA/EIA-568-B.3 requirements
- Adapter housing colors follow TIA/EIA-568-C.3 suggested color identification scheme
- Compatible with Mini-Com® products for complete modularity
- Improved protective cap fully surrounds split sleeve opening
- Choice of phosphor bronze or zirconia ceramic split sleeves to fit specific network requirements; zirconia ceramic split sleeves are recommended for OM3/OM4 multimode and OS1/OS2 singlemode applications
- Every adapter is laser marked with Q.C. number to assure 100% traceability
- Mini-Com® SC Simplex Adapter Modules are commonly used with Mini-Com® Patch Panels, Faceplates, and Surface Mount Boxes
- SC simplex and duplex adapters are also available separately on page C.30 and in patch panels or fiber adapter panels to provide a complete SC system solution



CMAQSC



CMBLSC



CMDEISCEI



CMSBUSCZ



CMSAGSCZ

Part Number	Part Description	No. of Module Spaces	Module Color‡	Std. Pkg. Qty.	Std. Ctn. Qty.
-------------	------------------	----------------------	---------------	----------------	----------------

SC Fiber Optic Adapter Modules – 10Gig™ OM3/OM4 50/125µm (Aqua Adapters)

CMSAQSCZBL	Module supplied with one SC 10Gig™ Simplex Multimode Fiber Optic Adapter (AQ) with zirconia ceramic split sleeve.	1	Black	1	10
CMSAQSCBL	Module supplied with one SC 10Gig™ Simplex Multimode Fiber Optic Adapter (AQ) with phosphor bronze split sleeve.	1	Black	1	10
CMDAQSCZBL	Module supplied with one SC 10Gig™ Duplex Multimode Fiber Optic Adapter (AQ) with zirconia ceramic split sleeves.	2	Black	1	10
CMDAQSCBL	Module supplied with one SC 10Gig™ Duplex Multimode Fiber Optic Adapter (AQ) with phosphor bronze split sleeves.	2	Black	1	10

SC Fiber Optic Adapter Modules – OM2 50/125µm (Black Adapters)

CMSBLSCBL	Module supplied with one SC simplex multimode fiber optic adapter (BL) with phosphor bronze split sleeve.	1	Black	1	10
CMDBLSCBL	Module supplied with one SC duplex multimode fiber optic adapter (BL) with phosphor bronze split sleeves.	2	Black	1	10

SC Fiber Optic Adapter Modules – OM1 62.5/125µm (Electric Ivory Adapters)

CMSEISCEI	Module supplied with one SC simplex multimode fiber optic adapter (EI) with phosphor bronze split sleeve.	1	Electric Ivory	1	10
CMDEISCEI	Module supplied with one SC duplex multimode fiber optic adapter (EI) with phosphor bronze split sleeves.	2	Electric Ivory	1	10

SC Fiber Optic Adapter Modules – OS1/OS2 9/125µm (Blue Adapters)

CMSBUSCZBU	Module supplied with one SC simplex singlemode fiber optic adapter (BU) with zirconia ceramic split sleeve.	1	Blue	1	10
CMDBUSCZBU	Module supplied with one SC duplex singlemode fiber optic adapter (BU) with zirconia ceramic split sleeves.	2	Blue	1	10

SC Fiber Optic Adapter Modules – APC OS1/OS2 9/125µm (Green Adapters)

CMSAGSCZBL	Module supplied with one SC APC simplex singlemode fiber optic adapter (AG) with zirconia ceramic split sleeve.	1	Black	1	10
CMDAGSCZBL	Module supplied with one SC APC duplex singlemode fiber optic adapter (AG) with zirconia ceramic split sleeves.	2	Black	1	10

‡For other colors module colors, replace suffix BL (Black), EL (Electric Ivory), or BU (Blue) with EI (Electric Ivory), BU (Blue), BL (Black), IW (Off White) or AW (Arctic White). 10Gig™ and APC Adapters are available in black modules only.

ST Mini-Com[®] Fiber Optic Adapter Modules

- TIA/EIA-604 FOCIS-2 compatible adapters
- Exceed TIA/EIA-568-B.3 requirements
- Compatible with Mini-Com[®] products for complete modularity
- Choice of phosphor bronze or zirconia ceramic split sleeves to fit specific network requirements; zirconia ceramic split sleeves are recommended for OM3/OM4 multimode and OS1/OS2 singlemode applications
- Mini-Com[®] ST Simplex Adapter Modules are commonly used with Mini-Com[®] Patch Panels
- ST simplex adapters are also available separately, and in patch panels or fiber adapter panels to provide a complete ST system solution

**CMSTZ**

Part Number	Part Description	No. of Module Spaces	Module Color‡	Std. Pkg. Qty.	Std. Ctn. Qty.
CMSTZBU	Module supplied with one ST singlemode fiber optic adapter with zirconia ceramic split sleeve.	1	Blue	1	10
CMSTEI	Module supplied with one ST multimode fiber optic adapter with phosphor bronze split sleeve.	1	Electric Ivory	1	10

‡For other colors replace suffix BU (Blue) or EI (Electric Ivory) with EI (Electric Ivory), BU (Blue), BL (Black), IW (Off White) or AW (Arctic White).



Mini-Com[®] Fiber Cable Strain Relief Module

- Provides pass-thru access and patented strain relief protection of fiber cable
- Commonly used with MDU installations on pages H.1 – H.5 and IndustrialNet[™] 8-port DIN Rail Fiber Optic Enclosure
- Compatible with Mini-Com[®] products for complete modularity



Part Number	Part Description	No. of Module Spaces	Module Color‡	Std. Pkg. Qty.	Std. Ctn. Qty.
CMCSRIW	Fiber cable strain relief module.	1	Off White	1	10

‡For other colors replace suffix IW (Off White) with BL (Black), BU (Blue), EI (Electric Ivory), IG (International Gray) or WH (White).



Mini-Com[®] Blank Module

- Secures opening to prevent tampering
- Compatible with Mini-Com[®] Modular Patch Panels, Faceplates, and Surface Mount Boxes



Part Number	Part Description	No. of Module Spaces	Color‡	Std. Pkg. Qty.	Std. Ctn. Qty.
CMBBL-X	1-position, reserves space for future use.	1	Black	10	50

‡For other colors replace suffix BL (Black) with IW (Off White), EI (Electric Ivory), WH (White) or IG (International Gray).

QuickNet™ Fiber Optic Migration Adapter Panels (FAPs)



- Factory assembled, and 100% tested
- Compatible with QuickNet™ Patch Panels
- Adapter housing colors follow TIA/EIA-568-C.3 suggested color identification scheme
- Significantly reduce installation time and labor by eliminating field connector terminations
- Lifetime traceability of test data to a Q.C. number on each fiber adapter panel



FQMAP45BL



FQMAP65BL



FQMAP85BL

Part Number	Part Description	Color	Std. Pkg. Qty.	Std. Ctn. Qty.
QuickNet™ Fiber Optic Migration Adapter Panels (FAPs)				
FQMAP45BL	QuickNet™ Fiber Optic Migration Adapter Panel – 4 MPO key-up/key-down adapters.	Black	1	10
FQMAP65BL	QuickNet™ Fiber Optic Migration Adapter Panel – 6 MPO key-up/key-down adapters.	Black	1	10
FQMAP85BL	QuickNet™ Fiber Optic Migration Adapter Panel – 8 MPO key-up/key-down adapters.	Black	1	10

QuickNet™ Fiber Optic Migration Adapter Panels are also available in Charcoal Gray (CG). Ex: FQMAP45BL to FQMAP46CG

NEW! **Opticom® MPO Fiber Optic Adapter Panels (FAPs)**

- Loaded with TIA/EIA-604 FOCIS-5 compliant adapters
- Exceed TIA/EIA-568-C.3 requirements
- Screen printed for horizontal or vertical orientation
- Designed for multimode or singlemode MPO connectors, patch cords, or cable assemblies
- Snap quickly into the front of all Opticom® and Opticom® QuickNet™ Components
- Can be used with Opticom® Zero RU Cable Management Solutions and QuickNet™ Hydra Cable Assemblies to facilitate connection to the active equipment



FAPH0412BLMPO



FAPH0612BLMPO



FAPH0812BLMPO



FAPH1212BLMPO



FAPH1612BLMPO



FAPV0612BLMPO



FAPV0812BLMPO

Part Number	Part Description	Color	Std. Pkg. Qty.	Std. Ctn. Qty.
Opticom® MPO Fiber Optic Adapter Panels (FAPs)				
FAPH0412BLMPO	Opticom® MPO FAP loaded with four (4) key-up/key-up MPO fiber optic adapters; oriented horizontally for Opticom® or Opticom® QuickNet™ Patch Panels and Fiber Enclosures.	Black	1	10
FAPH0612BLMPO	Opticom® MPO FAP loaded with six (6) key-up/key-up MPO fiber optic adapters; oriented horizontally for Opticom® or Opticom® QuickNet™ Patch Panels and Fiber Enclosures.	Black	1	10
FAPH0812BLMPO	Opticom® MPO FAP loaded with eight (8) key-up/key-up MPO fiber optic adapters; oriented horizontally for Opticom® or Opticom® QuickNet™ Patch Panels and Fiber Enclosures.	Black	1	10
FAPH1212BLMPO	Opticom® MPO FAP loaded with twelve (12) key-up/key-up MPO fiber optic adapters; oriented horizontally for Opticom® or Opticom® QuickNet™ Patch Panels and Fiber Enclosures.	Black	1	10
FAPH1612BLMPO	Opticom® MPO FAP loaded with sixteen (16) key-up/key-up MPO fiber optic adapters; oriented horizontally for Opticom® or Opticom® QuickNet™ Patch Panels and Fiber Enclosures.	Black	1	10
FAPH1812BLMPO	Opticom® MPO FAP loaded with eighteen (18) key-up/key-up MPO fiber optic adapters; oriented horizontally for Opticom® or Opticom® QuickNet™ Patch Panels and Fiber Enclosures.	Black	1	10
FAPV0412BLMPO	Opticom® MPO FAP loaded with four (4) key-up/key-up MPO fiber optic adapters; oriented vertically for Opticom® or Opticom® QuickNet™ Patch Panels and Fiber Enclosures.	Black	1	10
FAPV0612BLMPO	Opticom® MPO FAP loaded with six (6) key-up/key-up MPO fiber optic adapters; oriented vertically for Opticom® or Opticom® QuickNet™ Patch Panels and Fiber Enclosures.	Black	1	10
FAPV0812BLMPO	Opticom® MPO FAP loaded with eight (8) key-up/key-up MPO fiber optic adapters; oriented vertically for Opticom® or Opticom® QuickNet™ Patch Panels and Fiber Enclosures.	Black	1	10

MPO Fiber Optic Adapter Panels are also available in Charcoal Gray (CG). Ex: FAPH0412BLMPO to FAPH0412CGMPO.

LC Opticom® Fiber Adapter Panels (FAPs)

- Loaded with TIA/EIA-604 FOCIS-10 compatible adapters
- Exceed TIA/EIA-568-B.3 requirements
- Adapter housing colors follow TIA/EIA-568-C.3 suggested color identification scheme
- Snap quickly into the front of all Opticom® components
- LC fiber adapter panels are Sr./Jr. to conserve enclosure space
- Accept FOCIS-10 compatible senior LC connectors at either end and FOCIS-10 junior LC connectors at the inside end for behind the wall applications
- Both ends accept FOCIS-10 compatible senior LC connectors
- Junior end also accepts FOCIS-10 compatible junior (fixed ferrule/springless) LC connectors
- Choice of phosphor bronze or zirconia ceramic split sleeves to fit specific network requirements; zirconia ceramic split sleeves are recommended for OM3/OM4 multimode and OS1/OS2 singlemode applications
- Every adapter is laser marked with Q.C. number to assure 100% traceability
- LC adapters are also available in QuickNet™ Fiber Optic Cassettes on pages C.44 – C.48, Mini-Com® Modules on page C.33, or separately on pages C.28 – C.29 to provide a complete LC system solution



FAP12WAQDLCZ



FAP8WBLDLC



FAP6WEIDLC



FAP12WBULCZ

Part Number	Part Description	Std. Pkg. Qty.	Std. Ctn. Qty.
LC Fiber Adapter Panels – 10Gig™ OM3/OM4 50/125µm (Aqua Adapters)			
FAP6WAQDLCZ	LC 10Gig™ FAP loaded with six LC 10Gig™ Duplex Multimode Fiber Optic Adapters (Aqua) with zirconia ceramic split sleeves.	1	10
FAP6WAQDLC	LC 10Gig™ FAP loaded with six LC 10Gig™ Duplex Multimode Fiber Optic Adapters (Aqua) with phosphor bronze split sleeves.	1	10
FAP8WAQDLCZ	LC 10Gig™ FAP loaded with eight LC 10Gig™ Duplex Multimode Fiber Optic Adapters (Aqua) with zirconia ceramic split sleeves.	1	10
FAP8WAQDLC	LC 10Gig™ FAP loaded with eight LC 10Gig™ Duplex Multimode Fiber Optic Adapters (Aqua) with phosphor bronze split sleeves.	1	10
FAP12WAQDLCZ	LC 10Gig™ FAP loaded with twelve LC 10Gig™ Duplex Multimode Fiber Optic Adapters (Aqua) with zirconia ceramic split sleeves.	1	10
FAP12WAQDLC	LC 10Gig™ FAP loaded with twelve LC 10Gig™ Duplex Multimode Fiber Optic Adapters (Aqua) with phosphor bronze split sleeves.	1	10
LC Fiber Adapter Panels – OM2 50/125µm (Black Adapters)			
FAP6WBLDLC	LC FAP loaded with six LC duplex multimode fiber optic adapters (Black) with phosphor bronze split sleeves.	1	10
FAP8WBLDLC	LC FAP loaded with eight LC duplex multimode fiber optic adapters (Black) with phosphor bronze split sleeves.	1	10
FAP12WBLDLC	LC FAP loaded with twelve LC duplex multimode fiber optic adapters (Black) with phosphor bronze split sleeves.	1	10
LC Fiber Adapter Panels – OM1 62.5/125µm (Electric Ivory Adapters)			
FAP6WEIDLC	LC FAP loaded with six LC duplex multimode fiber optic adapters (Electric Ivory) with phosphor bronze split sleeves.	1	10
FAP8WEIDLC	LC FAP loaded with eight LC duplex multimode fiber optic adapters (Electric Ivory) with phosphor bronze split sleeves.	1	10
FAP12WEIDLC	LC FAP loaded with twelve LC duplex multimode fiber optic adapters (Electric Ivory) with phosphor bronze split sleeves.	1	10
LC Fiber Adapter Panels – OS1/OS2 9/125µm (Blue Adapters)			
FAP12WBULCZ	LC FAP loaded with twelve LC simplex singlemode fiber optic adapters (Blue) with zirconia ceramic split sleeves.	1	10
FAP6WBUDLCZ	LC FAP loaded with six LC duplex singlemode fiber optic adapters (Blue) with zirconia ceramic split sleeves.	1	10
FAP8WBUDLCZ	LC FAP loaded with eight LC duplex singlemode fiber optic adapters (Blue) with zirconia ceramic split sleeves.	1	10
FAP12WBUDLCZ	LC FAP loaded with twelve LC duplex singlemode fiber optic adapters (Blue) with zirconia ceramic split sleeves.	1	10



Keyed LC Opticom[®] Fiber Adapter Panels (FAPs)

- Include color-specific keys with positive and negative keying features to visually and mechanically distinguish connections to prevent unauthorized mating with unlike keyed or non-keyed connectors and patch cords
- Part of a complete keyed LC system that includes Opti-Core[®] Patch Cords and Pigtails, OptiCam[®] Pre-Polished Cam Connectors, Opticom[®] Fiber Adapter Panels (FAPs), and Mini-Com[®] Adapter Modules
- Snap quickly into the front of all Opticom[®] components
- Provide a keyed senior adapter interface at each end for keyed LC connectivity
- Include zirconia ceramic split sleeves for superior performance and reliability
- Every adapter is laser marked with Q.C. number to assure 100% traceability
- Keyed LC adapters are also available in Keyed LC QuickNet[™] Fiber Optic Cassettes on pages C.49 – C.53, or Keyed LC Mini-Com[®] Modules on page C.34 to provide a complete keyed LC system solution

Part Number	Part Description	Key Type and Color	Std. Pkg. Qty.	Std. Ctn. Qty.
-------------	------------------	--------------------	----------------	----------------

Keyed LC Fiber Adapter Panels – Six Adapters

FAP6WABLDLCZ	Keyed LC FAP loaded with six LC (keyed A – black) duplex fiber optic adapters with zirconia ceramic split sleeves.	Keyed A – Black	1	10
FAP6WBRDDLDCZ	Keyed LC FAP loaded with six LC (keyed B – red) duplex fiber optic adapters with zirconia ceramic split sleeves.	Keyed B – Red	1	10
FAP6WCGRDLCZ	Keyed LC FAP loaded with six LC (keyed C – green) duplex fiber optic adapters with zirconia ceramic split sleeves.	Keyed C – Green	1	10
FAP6WDYLDLCZ	Keyed LC FAP loaded with six LC (keyed D – yellow) duplex fiber optic adapters with zirconia ceramic split sleeves.	Keyed D – Yellow	1	10
FAP6WEORDLCZ	Keyed LC FAP loaded with six LC (keyed E – orange) duplex fiber optic adapters with zirconia ceramic split sleeves.	Keyed E – Orange	1	10
FAP6WFDBDLCZ	Keyed LC FAP loaded with six LC (keyed F – dark blue) duplex fiber optic adapters with zirconia ceramic split sleeves.	Keyed F – Dark Blue	1	10

Keyed LC Fiber Adapter Panels – Eight Adapters

FAP8WABLDLCZ	Keyed LC FAP loaded with eight LC (keyed A – black) duplex fiber optic adapters with zirconia ceramic split sleeves.	Keyed A – Black	1	10
FAP8WBRDDLDCZ	Keyed LC FAP loaded with eight LC (keyed B – red) duplex fiber optic adapters with zirconia ceramic split sleeves.	Keyed B – Red	1	10
FAP8WCGRDLCZ	Keyed LC FAP loaded with eight LC (keyed C – green) duplex fiber optic adapters with zirconia ceramic split sleeves.	Keyed C – Green	1	10
FAP8WDYLDLCZ	Keyed LC FAP loaded with eight LC (keyed D – yellow) duplex fiber optic adapters with zirconia ceramic split sleeves.	Keyed D – Yellow	1	10
FAP8WEORDLCZ	Keyed LC FAP loaded with eight LC (keyed E – orange) duplex fiber optic adapters with zirconia ceramic split sleeves.	Keyed E – Orange	1	10
FAP8WFDBDLCZ	Keyed LC FAP loaded with eight LC (keyed F – dark blue) duplex fiber optic adapters with zirconia ceramic split sleeves.	Keyed F – Dark Blue	1	10

Keyed LC Fiber Adapter Panels – Twelve Adapters

FAP12WABLDLCZ	Keyed LC FAP loaded with twelve LC (keyed A – black) duplex fiber optic adapters with zirconia ceramic split sleeves.	Keyed A – Black	1	10
FAP12WBRDDLDCZ	Keyed LC FAP loaded with twelve LC (keyed B – red) duplex fiber optic adapters with zirconia ceramic split sleeves.	Keyed B – Red	1	10
FAP12WCGRDLCZ	Keyed LC FAP loaded with twelve LC (keyed C – green) duplex fiber optic adapters with zirconia ceramic split sleeves.	Keyed C – Green	1	10
FAP12WDYLDLCZ	Keyed LC FAP loaded with twelve LC (keyed D – yellow) duplex fiber optic adapters with zirconia ceramic split sleeves.	Keyed D – Yellow	1	10
FAP12WEORDLCZ	Keyed LC FAP loaded with twelve LC (keyed E – orange) duplex fiber optic adapters with zirconia ceramic split sleeves.	Keyed E – Orange	1	10
FAP12WFDBDLCZ	Keyed LC FAP loaded with twelve LC (keyed F – dark blue) duplex fiber optic adapters with zirconia ceramic split sleeves.	Keyed F – Dark Blue	1	10

The Keyed LC Fiber Optic System is now offering 18 colors to ensure network physical layer security with color-specific keyed connectivity. For complete keyed solutions, please reference www.panduit.com.

**FAP6WBRDDLDCZ****FAP8WEORDLCZ****FAP12WDYLDLCZ**

SC Opticom® Fiber Adapter Panels (FAPs)

- Loaded with TIA/EIA-604 FOCIS-3 compliant adapters
- Exceed TIA/EIA-568-C.3 requirements
- Adapter housing colors follow TIA/EIA-568-C.3 suggested color identification scheme
- Snap quickly into the front of all Opticom® components
- Choice of phosphor bronze or zirconia ceramic split sleeves to fit specific network requirements; zirconia ceramic split sleeves are recommended for OM3/OM4 multimode and OS1/OS2 singlemode applications
- Q.C. number and split sleeve material laser marked on every adapter assures 100% traceability and quick and easy identification of split sleeve material
- SC adapters are also available in QuickNet™ Fiber Optic Cassettes on pages C.46 – C.53, Mini-Com® Modules on page C.35, or separately on page C.30 to provide a complete SC system solution



FAP6WAQDSCZ



FAP4WBLDSC

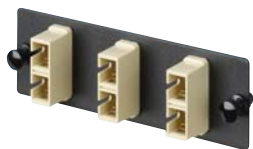

FAP3WEIDSC

Part Number	Part Description	Std. Pkg. Qty.	Std. Ctn. Qty.
SC Fiber Adapter Panels – 10Gig™ OM3/OM4 50/125µm (Aqua Adapters)			
FAP6WAQSCZ	SC 10Gig™ FAP loaded with six SC 10Gig™ Simplex Multimode Fiber Optic Adapters (Aqua) with zirconia ceramic split sleeves.	1	10
FAP6WAQSC	SC 10Gig™ FAP loaded with six SC 10Gig™ Simplex Multimode Fiber Optic Adapters (Aqua) with phosphor bronze split sleeves.	1	10
FAP2WAQDSCZ	SC 10Gig™ FAP loaded with two SC 10Gig™ Duplex Multimode Fiber Optic Adapters (Aqua) with zirconia ceramic split sleeves.	1	10
FAP3WAQDSCZ	SC 10Gig™ FAP loaded with three SC 10Gig™ Duplex Multimode Fiber Optic Adapters (Aqua) with zirconia ceramic split sleeves.	1	10
FAP4WAQDSCZ	SC 10Gig™ FAP loaded with four SC 10Gig™ Duplex Multimode Fiber Optic Adapters (Aqua) with zirconia ceramic split sleeves.	1	10
FAP6WAQDSCZ	SC 10Gig™ FAP loaded with six SC 10Gig™ Duplex Multimode Fiber Optic Adapters (Aqua) with zirconia ceramic split sleeves.	1	10
FAP2WAQDSC	SC 10Gig™ FAP loaded with two SC 10Gig™ Duplex Multimode Fiber Optic Adapters (Aqua) with phosphor bronze split sleeves.	1	10
FAP3WAQDSC	SC 10Gig™ FAP loaded with three SC 10Gig™ Duplex Multimode Fiber Optic Adapters (Aqua) with phosphor bronze split sleeves.	1	10
FAP4WAQDSC	SC 10Gig™ FAP loaded with four SC 10Gig™ Duplex Multimode Fiber Optic Adapters (Aqua) with phosphor bronze split sleeves.	1	10
FAP6WAQDSC	SC 10Gig™ FAP loaded with six SC 10Gig™ Duplex Multimode Fiber Optic Adapters (Aqua) with phosphor bronze split sleeves.	1	10
SC Fiber Adapter Panels – OM2 50/125µm (Black Adapters)			
FAP6WBLSC	SC FAP loaded with six SC simplex multimode fiber optic adapters (Black) with phosphor bronze split sleeves.	1	10
FAP12WBLSC	SC FAP loaded with twelve SC simplex multimode fiber optic adapters (Black) with phosphor bronze split sleeves.	1	10
FAP2WBLDSC	SC FAP loaded with two SC duplex multimode fiber optic adapters (Black) with phosphor bronze split sleeves.	1	10
FAP3WBLDSC	SC FAP loaded with three SC duplex multimode fiber optic adapters (Black) with phosphor bronze split sleeves.	1	10
FAP4WBLDSC	SC FAP loaded with four SC duplex multimode fiber optic adapters (Black) with phosphor bronze split sleeves.	1	10
FAP6WBLDSC	SC FAP loaded with six SC duplex multimode fiber optic adapters (Black) with phosphor bronze split sleeves.	1	10
SC Fiber Adapter Panels – OM1 62.5/125µm (Electric Ivory Adapters)			
FAP6WEISC	SC FAP loaded with six SC simplex multimode fiber optic adapters (Electric Ivory) with phosphor bronze split sleeves.	1	10
FAP12WEISC	SC FAP loaded with twelve SC simplex multimode fiber optic adapters (Electric Ivory) with phosphor bronze split sleeves.	1	10
FAP2WEIDSC	SC FAP loaded with two SC duplex multimode fiber optic adapters (Electric Ivory) with phosphor bronze split sleeves.	1	10
FAP3WEIDSC	SC FAP loaded with three SC duplex multimode fiber optic adapters (Electric Ivory) with phosphor bronze split sleeves.	1	10
FAP4WEIDSC	SC FAP loaded with four SC duplex multimode fiber optic adapters (Electric Ivory) with phosphor bronze split sleeves.	1	10
FAP6WEIDSC	SC FAP loaded with six SC duplex multimode fiber optic adapters (Electric Ivory) with phosphor bronze split sleeves.	1	10

Table continues on page C.42

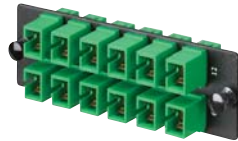
SC Opticom[®] Fiber Adapter Panels (FAPs) (continued)**FAP12WBUSCZ****FAP4WBUDSCZ****FAP12WAGSCZ**

Part Number	Part Description	Std. Pkg. Qty.	Std. Ctn. Qty.
SC Fiber Adapter Panels – OS1/OS2 9/125µm (Blue Adapters)			
FAP6WBUSCZ	SC FAP loaded with six SC simplex singlemode fiber optic adapters (Blue) with zirconia ceramic split sleeves.	1	10
FAP12WBUSCZ	SC FAP loaded with twelve SC simplex singlemode fiber optic adapters (Blue) with zirconia ceramic split sleeves.	1	10
FAP2WBUDSCZ	SC FAP loaded with two SC duplex singlemode fiber optic adapters (Blue) with zirconia ceramic split sleeves.	1	10
FAP3WBUDSCZ	SC FAP loaded with three SC duplex singlemode fiber optic adapters (Blue) with zirconia ceramic split sleeves.	1	10
FAP4WBUDSCZ	SC FAP loaded with four SC duplex singlemode fiber optic adapters (Blue) with zirconia ceramic split sleeves.	1	10
FAP6WBUDSCZ	SC FAP loaded with six SC duplex singlemode fiber optic adapters (Blue) with zirconia ceramic split sleeves.	1	10
SC Fiber Adapter Panels – APC OS1/OS2 9/125µm (Green Adapters)			
FAP6WAGSCZ	SC APC FAP loaded with six SC APC simplex singlemode fiber optic adapters (Green) with zirconia ceramic split sleeves.	1	10
FAP12WAGSCZ	SC APC FAP loaded with twelve SC APC simplex singlemode fiber optic adapters (Green) with zirconia ceramic split sleeves.	1	10
FAP2WAGDSCZ	SC APC FAP loaded with two SC APC duplex singlemode fiber optic adapters (Green) with zirconia ceramic split sleeves.	1	10
FAP3WAGDSCZ	SC APC FAP loaded with three SC APC duplex singlemode fiber optic adapters (Green) with zirconia ceramic split sleeves.	1	10
FAP4WAGDSCZ	SC APC FAP loaded with four SC APC duplex singlemode fiber optic adapters (Green) with zirconia ceramic split sleeves.	1	10
FAP6WAGDSCZ	SC APC FAP loaded with six SC APC duplex singlemode fiber optic adapters (Green) with zirconia ceramic split sleeves.	1	10

ST Opticom® Fiber Adapter Panels (FAPs)

- Loaded with TIA/EIA-604 FOCIS-2 compatible adapters
- Exceed TIA/EIA-568-B.3 requirements
- Snap quickly into the front of all Opticom® components
- Choice of phosphor bronze or zirconia ceramic split sleeves to fit specific network requirements; zirconia ceramic split sleeves are recommended for OM3 multimode and OS1/OS2 singlemode applications
- ST adapters are also available in Mini-Com® Modules on pages C.36 – C.38, or separately on page C.31 to provide a complete ST system solution



FAP6WSTZ



FAP6WSTA

Part Number	Part Description	Std. Pkg. Qty.	Std. Ctn. Qty.
FAP6WSTZ	ST FAP loaded with six ST simplex singlemode fiber optic adapters with zirconia ceramic split sleeves.	1	10
FAP8WSTZ	ST FAP loaded with eight ST simplex singlemode fiber optic adapters with zirconia ceramic split sleeves.	1	10
FAP6WST	ST FAP loaded with six ST simplex multimode fiber optic adapters with phosphor bronze split sleeves.	1	10
FAP6WSTA	ST FAP (angled) loaded with six ST simplex multimode fiber optic adapters with phosphor bronze split sleeves.	1	10
FAP8WST	ST FAP loaded with eight ST simplex multimode fiber optic adapters with phosphor bronze split sleeves.	1	10

Opticom® Multimedia Modular Panel (FMP)

- Allows customization of installation for multimedia applications requiring integration of fiber optic and copper cables
- Snaps quickly into the front of all Opticom® components



Part Number	Part Description	Std. Pkg. Qty.	Std. Ctn. Qty.
FMP6	Unloaded panel accepts up to six Mini-Com® Modules for UTP, fiber optic, and audio/video applications.	1	10

Opticom® Blank Fiber Adapter Panel (FAP)

- Reserves fiber adapter panel space for future use
- Snaps quickly into the front of all Opticom® components



Part Number	Part Description	Std. Pkg. Qty.	Std. Ctn. Qty.
FAPB	Blank fiber adapter panel – reserves space for future use.	1	10

QuickNet™ SFQ Series MTP* Fiber Optic Cassettes

- Compatible with QuickNet™ Patch Panels for up to 96 fiber connections in 1RU with QAPP48HDBL QuickNet™ 48-port Angled Patch Panel
- Low insertion loss of 0.5dB max. per cassette and 1.0dB max. per standard cassette; ensures system meets IEEE 802.3ae max. channel loss specification of <2.6dB
- Return loss: ≥26dB (10Gig™ multimode), ≥20dB (multimode), ≥55dB (singlemode)
- Connect together with high-density female MTP* cable assemblies as interconnecting network segments for deploying a remote or data center location in minutes
- Significantly reduce installation time and labor by eliminating field connector terminations
- Factory terminated, assembled and 100% tested
- Insertion loss data provided on every fiber cassette
- Return loss data provided on all singlemode fiber cassettes
- Lifetime traceability of test data to a Q.C. number on each fiber cassette
- 10Gig™ OM4 50/125µm Fiber Cassettes are tested per IEEE 802.3ae 10 GbE to support network transmission speeds up to 10 Gb/s for link lengths up to 550 meters at 850nm; backward compatible with all 50/125µm (OM2) MPO or MTP* system requirements



FQZO-12-10



FQX-6-3

Part Number	Part Description	Std. Pkg. Qty.	Std. Ctn. Qty.
Optimized 10Gig™ 50/125µm (OM4) Multimode SFQ Series MTP* Cassettes			
FQZO-12-10	Optimized OM4 10Gig™ 50/125µm Six LC duplex adapters to one male MTP*; 12-fiber optimized pre-terminated MTP* rear mount cassette provides low insertion loss of 0.5dB max. per fiber. Method A.	1	10
FQZO-12-10B	Optimized OM4 10Gig™ 50/125µm Six LC duplex adapters to one male MTP*; 12-fiber optimized pre-terminated MTP* rear mount cassette provides low insertion loss of 0.5dB max. per fiber. Method A, pair flipped.	1	10
FQZO-6-3	Optimized OM4 10Gig™ 50/125µm Three SC duplex adapters to one male MTP*; 12-fiber optimized pre-terminated MTP* rear mount cassette provides low insertion loss of 0.5dB max. per fiber. Method A.	1	10
10Gig™ 50/125µm (OM4) Multimode SFQ Series MTP* Cassettes			
FQZ-12-10	Six LC duplex adapters to one male MTP*; 12-fiber pre-terminated MTP* rear mount cassette provides low insertion loss of 1.0dB max. per fiber; 10Gig™ 50/125µm (OM4) fiber. Method A.	1	10
FQZ-12-10B	Six LC duplex adapters to one male MTP*; 12-fiber pre-terminated MTP* rear mount cassette provides low insertion loss of 1.0dB max. per fiber; 10Gig™ 50/125µm (OM4) fiber. Method A, pair flipped.	1	10
FQZ-6-3	OM4 10Gig™ 50/125µm Three SC duplex adapters to one male MTP*; 6-fiber pre-terminated MTP* rear mount cassette provides low insertion loss of 1.0dB max. per fiber. Method A.	1	10
Optimized 10Gig™ 50/125µm (OM3) Multimode SFQ Series MTP* Cassettes			
FQXO-12-10	Optimized OM3 10Gig™ 50/125µm Six LC duplex adapters to one male MTP*; 12-fiber optimized pre-terminated MTP* rear mount cassette provides low insertion loss of 0.5dB max. per fiber. Method A.	1	10
FQXO-12-10B	Optimized OM3 10Gig™ 50/125µm Six LC duplex adapters to one male MTP*; 12-fiber optimized pre-terminated MTP* rear mount cassette provides low insertion loss of 0.5dB max. per fiber. Method A, pair flipped.	1	10
FQXO-6-3	Optimized 10Gig™ 50/125µm OM3 Three SC duplex adapters to one male MTP*; 6-fiber optimized pre-terminated MTP* rear mount cassette provides low insertion loss of 0.5dB max. per fiber.	1	10
10Gig™ 50/125µm (OM3) Multimode SFQ Series MTP* Cassettes			
FQX-12-10	OM3 10Gig™ 50/125µm Six LC duplex adapters to one male MTP*; 12-fiber pre-terminated MTP* rear mount SFQ cassette provides low insertion loss of 1.0dB max. per fiber.	1	10
FQX-12-10B	OM3 10Gig™ 50/125µm Six LC duplex adapters to one male MTP*; 12-fiber pre-terminated MTP* rear mount SFQ cassette provides low insertion loss of 1.0dB max. per fiber. Method A, pair flipped.	1	10
FQX-6-3	OM3 10Gig™ 50/125µm Three SC duplex adapters to one male MTP*; 6-fiber pre-terminated MTP* rear mount cassette provides low insertion loss of 1.0dB max. per fiber.	1	10

Please refer to Product Bulletin number WW-FBCB35 for complete part number ordering information.

*MTP is a registered trademark of US Conec Ltd.

QuickNet™ SFQ Series MTP* Fiber Optic Cassettes (continued)



FQ6-6-3



FQ9-12-10

Part Number	Part Description	Std. Pkg. Qty.	Std. Ctn. Qty.
50/125µm (OM2) Multimode SFQ Series MTP* Cassettes			
FQ5-12-10	OM2 50/125µm Six LC duplex adapters to one male MTP*; 12-fiber pre-terminated MTP* rear mount cassette provides low insertion loss of 1.0dB max. per fiber.	1	10
FQ5-6-3	OM2 50/125µm Three SC duplex adapters to one male MTP*; 6-fiber pre-terminated MTP* rear mount cassette provides low insertion loss of 1.0dB max. per fiber.	1	10
62.5/125µm (OM1) Multimode SFQ Series MTP* Cassettes			
FQ6-12-10	OM1 62.5/125µm Six LC duplex adapters to one male MTP*; 12-fiber pre-terminated MTP* rear mount cassette provides low insertion loss of 1.0dB max. per fiber.	1	10
FQ6-6-3	OM1 62.5/125µm Three SC duplex adapters to one male MTP*; 6-fiber pre-terminated MTP* rear mount cassette provides low insertion loss of 1.0dB max. per fiber.	1	10
9/125µm (OS1/OS2) Singlemode SFQ Series MTP* Cassettes			
FQ9-12-10	OS1/OS2 Singlemode Six LC duplex adapters to one male MTP*; 12-fiber pre-terminated MTP* rear mount cassette provides low insertion loss of 1.0dB max. per fiber.	1	10
FQ9-6-3	OS1/OS2 singlemode Three SC duplex adapters to one male MTP*; 6-fiber pre-terminated MTP* rear mount cassette provides low insertion loss of 1.0dB max. per fiber.	1	10

Please refer to Product Bulletin number WW-FBCB35 for complete part number ordering information.

*MTP is a registered trademark of US Conec Ltd.

QuickNet™ High Density SFQ Small Form Factor Cable Assemblies

- Unique industry-leading proprietary MTP* polishing process
- Identical copper and fiber cassette form factor offers design flexibility, easy maintenance and upgrade enabling a unified, highly scalable pre-terminated solution
- High-density design maximizes density with up to 72 fibers in one cassette, 576 in 1RU; combination of design features provide a lower total cost of ownership
- MTP* 12-fiber connector provides reduced overall insertion loss with low channel to channel variability
- 100% tested with test data provided for each product
- Factor verified optical performance provides channel to channel consistency and reliability for improved network integrity
- Pre-terminated modular cassette system provides quick deployment that reduces installation time and cost.
- Product is compatible with QuickNet™ Patch Panels and uses the same cassette form factor as Copper QuickNet™ Patch Panels (or cable assemblies)
- Product identification with data labels and QC numbers which are supplied with each product for quick port identification and 100% traceability



FQPX48VVM050N

Part Number	Part Description	Std. Pkg. Qty.	Std. Ctn. Qty.
High Density SFQ Small Form Factor Cable Assemblies			
FQPX48VVM050N	48 Fiber 10Gig™ plenum rated high density Female MTP SFQ Cassette to Female MTP SFQ Cassette cable assembly – 50m	1	1

QuickNet™ LC/SC SFQ Small Form Factor Cable Assemblies are also available in 72 and 96 fiber solutions.

Please refer to Product Bulletin number WW-FBCB35 for complete part number ordering information.

* – MTP is a registered trademark of US Conec LTD.

Quicknet™ HDQ Series High Density Fiber Optic Cassettes

- Mounts to standard 19" rack rails
- Low insertion loss of 0.5dB max, per optimized cassette and 0.75dB max, per standard cassette; ensures system meets IEEE 802.3ae max. channel loss specification of = 26dB
- Adapter housing colors follow TIA/EIA-568-C.3 suggested color identification scheme
- Connect together with high-density female MTP* cable assemblies as interconnection network
- Significantly reduce installation time and labor by eliminating field connector termination
- Factory terminated, assembled, and 100% tested
- Insertion loss data provided on every fiber cassette
- Lifetime traceability of test data to a Q.C. number
- 10Gig OM4 50/125um fiber cassettes are tested per IEEE 802.3ae 10 GbE to support network transmission speeds up to 10 Gb/s for link lengths up to 550 meters at 850 nm; backward compatible with all 50/125um (OM2) MPO or MTP system requirements

**F1RBZN****F1RCZN****F1ASZN****F1RSZN****F1AS9N**

Part Number	Part Description	Std. Pkg. Qty.	Std. Ctn. Qty.
-------------	------------------	----------------	----------------

QuickNet™ HDQ Series High Density Fiber Optic Cassette - B Type

F1RBZN-9608-10[^]	QuickNet™ HDQ Series High Density Fiber Optic Cassette; 1RU 96-fiber B-type labeling; 10Gb OM4 8-fiber MTP to LC pre-terminated – standard polarity.	1	—
F1RBZN-9608-10[^]	QuickNet™ HDQ Series High Density Fiber Optic Cassette; 1RU 96-fiber B-type labeling; 10Gb OM4 8-fiber MTP to LC pre-terminated – flipped polarity.	1	—

Quicknet™ HDQ Series High Density Fiber Optic Cassette - C Type

F1RCZN-9612-10[^]	QuickNet™ HDQ Series High Density Fiber Optic Cassette; 1RU 96-fiber C-type labeling; 10Gb OM4 12-fiber MTP to LC pre-terminated – standard polarity.	1	—
F1RCZN-9612-10[^]	QuickNet™ HDQ Series High Density Fiber Optic Cassette; 1RU 96-fiber C-type labeling; 10Gb OM4 12-fiber MTP to LC pre-terminated – flipped polarity.	1	—

Quicknet™ HDQ Series High Density Fiber Optic Cassette - Angled

F1ASZN-9612-10[^]	QuickNet™ HDQ Series High Density Fiber Optic Cassette; 1RU-Angled 96-fiber S-type labeling; 10Gb OM4 12-fiber MTP to LC pre-terminated – standard polarity.	1	—
F1ASZN-9612-10[^]	QuickNet™ HDQ Series High Density Fiber Optic Cassette; 1RU-Angled 96-fiber S-type labeling; 10Gb OM4 12-fiber MTP to LC pre-terminated – flipped polarity.	1	—

Quicknet™ HDQ Series High Density Fiber Optic Cassette - S Type

F1RSZN-9612-10[^]	QuickNet™ HDQ Series High Density Fiber Optic Cassette; 1RU 96-fiber C-type labeling; 10Gb OM4 12-fiber MTP to LC pre-terminated, standard polarity.	1	—
F1RSZO-9612-10[^]	QuickNet™ optimized HDQ Series high density fiber optic cassette; 1 RU 96-fiber S-type labeling; 10Gig OM4 12-fiber MTP to LC pre-terminated, standard polarity	1	—
F1RSXN-9612-10[^]	QuickNet™ HDQ Series high density fiber optic cassette; 1 RU 96-fiber S-type labeling; 10Gig OM3 12-fiber MTP to LC pre-terminated, standard polarity	1	—
F1RSXO-9612-10[^]	QuickNet™ optimized HDQ Series high density fiber optic cassette; 1 RU 96-fiber S-type labeling; 10Gig OM3 12-fiber MTP to LC pre-terminated, standard polarity	1	—

Quicknet™ HDQ Series High Density Fiber Optic Cassette Singlemode - S Type

F1AS9N-1A12-10F	QuickNet™ HDQ Series high density fiber optic cassette, 144-fiber S-type labeling, singlemode, 12-fiber MPO to LC pre-terminated, flipped polarity.	1	—
F1AS9N-1A12-10S	QuickNet™ HDQ Series high density fiber optic cassette, 144-fiber S-type labeling, singlemode, 12-fiber MPO to LC pre-terminated, standard polarity.	1	—

For OM3 cassettes, replace "Z" with "X"; for OM4 cassettes, replace "X" with "Z". For optimized cassettes, replace "N" with "O".

[^] Use "S" for Standard Polarity and "F" for Flipped Polarity.

QuickNet™ HDQ Series High Density Fiber Optic Cassettes (continued)



FQCRCM



FPFPC1

Part Number	Part Description	Std. Pkg. Qty.	Std. Ctn. Qty.
QuickNet™ Rear Cable Manager			
FQCRCM	QuickNet™ Cassette Rear Cable Manager manages up to one meter of slack for each of 16 MTP* Interconnect Cables in support of QuickNet™ SFQ Cassettes, QuickNet™ HDQ Cassettes, or QuickNet™ MTP Cassettes. <i>Intended for Panduit® 2-Post Racks ONLY. Not intended for 4-post racks, server cabinets or network cabinets.</i>	1	10
QuickNet™ Fiber Patch Field Protection Cover			
FPFPC1	1RU Fiber Patch Field Protection Cover protects front patch field, minimizing potential for connector damage and fiber attenuation. Includes a labeling card for identification of ports and D-rings to provide physical support to fiber and control bend radius. <i>Not compatible with Opticom® Angled and QuickNet™ Angled Patch Panels</i>	1	—

For OM3 cassettes, replace "Z" with "X"; for OM4 cassettes, replace "X" with "Z". For optimized cassettes, replace "N" with "O".

^ Use "S" for Standard Polarity and "F" for Flipped Polarity.

QuickNet™ MTP* Fiber Optic Cassettes

- Compatible with Opticom® QuickNet™ Rack Mount Fiber Cassette Enclosures on page C.54, Opticom® Zero RU Cable Management Solutions on page C.57, and Opticom® Wall Mount Enclosures on page C.60, for up to 96 fiber connections in 1RU
- Low insertion loss of 0.5dB max. per optimized cassette and 1.0dB max. per standard cassette; ensures system meets IEEE 802.3ae max. channel loss specification of <2.6dB
- Return loss: ≥26dB (10Gig™ multimode), ≥20dB (multimode), ≥55dB (singlemode)
- Adapter housing colors follow TIA/EIA-568-C.3 suggested color identification scheme
- Connect together with high-density female MTP* cable assemblies as interconnecting network segments for deploying a remote or data center location in minutes
- Significantly reduce installation time and labor by eliminating field connector terminations
- Factory terminated, assembled, and 100% tested
- Insertion loss data provided on every fiber cassette
- Return loss data provided on all singlemode fiber cassettes
- Lifetime traceability of test data to a Q.C. number on each fiber cassette
- 10Gig™ OM3 50/125µm Fiber Cassettes are tested per IEEE 802.3ae 10 GbE to support network transmission speeds up to 10 Gb/s for link lengths up to 300 meters and up to 550 meters for OM4 at 850nm; backward compatible with all 50/125µm (OM2) MPO or MTP* system requirements



FCXO-24-10Y



FCXO-24-10BY



FCX-12-3Y

Part Number	Part Description	Std. Pkg. Qty.	Std. Ctn. Qty.
Optimized 10Gig™ 50/125µm (OM4) Multimode MTP* Cassettes			
FCZO-12-10Y	Optimized OM4 10Gig™ QuickNet™ six LC duplex adapters to one male MTP* connector. Method A.	1	10
FCZO-12-10BY	Optimized OM4 10Gig™ QuickNet™ six LC duplex adapters to one male MTP* connector. Modified Method A – pair flipped wiring scheme.	1	10
FCZO-24-10Y	Optimized OM4 10Gig™ QuickNet™ twelve LC duplex adapters to two male MTP* connectors. Method A.	1	10
FCZO-24-10BY	Optimized OM4 10Gig™ QuickNet™ twelve LC duplex adapters to two male MTP* connectors. Modified Method A – pair flipped wiring scheme.	1	10
FCZO-12-3Y	Optimized OM4 10Gig™ QuickNet™ six SC duplex adapters to one male MTP* connector. Method A.	1	10
Optimized 10Gig™ 50/125µm (OM3) Multimode MTP* Cassettes			
FCXO-12-10Y	Optimized OM3 10Gig™ 50/125µm six LC duplex adapters to one male 12-fiber pre-terminated MTP*connector.	1	10
FCXO-12-10BY	Optimized OM3 10Gig™ QuickNet™ six LC duplex adapters to one male MTP* connector. Modified Method A – pair flipped wiring scheme.	1	10
FCXO-24-10Y	Optimized OM3 10Gig™ 50/125µm twelve LC duplex adapters to two male 12-fiber pre-terminated MTP*connectors.	1	10
FCXO-24-10BY	Optimized OM3 10Gig™ QuickNet™ twelve LC duplex adapters to two male MTP* connectors. Modified Method A – pair flipped wiring scheme.	1	10

Table continues on page C.48

QuickNet™ MTP* Fiber Optic Cassettes (continued)



FC6-12-10Y



FC6-24-10Y

Part Number	Part Description	Std. Pkg. Qty.	Std. Ctn. Qty.
FCXO-12-3Y	Optimized OM3 10Gig™ 50/125µm six SC duplex adapters to one male 12-fiber pre-terminated MTP* connector.	1	10

10Gig™ 50/125µm (OM4) Multimode MTP* Cassettes

FCZ-12-10Y	OM4 10Gig™ QuickNet™ six LC duplex adapters to one male MTP* connector. Method A.	1	10
FCZ-12-10BY	OM4 10Gig™ QuickNet™ six LC duplex adapters to one male MTP* connector. Modified Method A – pair flipped wiring scheme.	1	10
FCZ-24-10Y	OM4 10Gig™ QuickNet™ twelve LC duplex adapters to two male MTP* connectors. Method A.	1	10
FCZ-24-10BY	OM4 10Gig™ QuickNet™ twelve LC duplex adapters to two male MTP* connectors. Modified Method A – pair flipped wiring scheme.	1	10
FCZ-12-3Y	OM4 10Gig™ QuickNet™ six SC duplex adapters to one male MTP* connector. Method A.	1	10

10Gig™ 50/125µm (OM3) Multimode SFQ Series MTP* Cassettes

FCX-12-10Y	OM3 10Gig™ 50/125µm six LC duplex adapters to one male 12-fiber pre-terminated MTP*connector.	1	10
FCX-12-10BY	OM3 10Gig™ QuickNet™ six LC duplex adapters to two male MTP* connectors. Modified Method A, pair flipped wiring scheme.	1	10
FCX-24-10Y	OM3 10Gig™ 50/125µm twelve LC duplex adapters to two male 12-fiber pre-terminated MTP* connectors.	1	10
FCX-24-10BY	OM3 10Gig™ QuickNet™ twelve LC duplex adapters to two male MTP* connectors. Modified Method A, pair flipped wiring scheme.	1	10
FCX-12-3SY	OM3 10Gig™ 50/125µm six SC simplex adapters to one male 12-fiber pre-terminated MTP* connector.	1	10
FCX-12-3Y	OM3 10Gig™ 50/125µm six SC duplex adapters to one male 12-fiber pre-terminated MTP* connector.	1	10

50/125µm (OM2) Multimode MTP* Cassettes

FC5-12-10Y	OM2 50/125µm six LC duplex adapters to one male MTP*; 12-fiber pre-terminated MTP* cassette provides low insertion loss of 1.0dB max. per fiber.	1	10
FC5-24-10Y	OM2 50/125µm twelve LC duplex adapters to two male 12-fiber pre-terminated MTP*connectors.	1	10
FC5-12-3SY	OM2 50/125µm twelve SC simplex adapters to one male 12-fiber pre-terminated MTP* connector.	1	10
FC5-12-3Y	OM2 50/125µm six SC simplex adapters to one male 12-fiber pre-terminated MTP* connector.	1	10

62.5/125µm (OM1) Multimode MTP* Cassettes

FC6-12-10Y	OM1 62.5/125µm six LC duplex adapters to one male 12-fiber pre-terminated MTP* connector.	1	10
FC6-24-10Y	OM1 62.5/125µm twelve LC duplex adapters to two male 12-fiber pre-terminated MTP*connectors.	1	10
FC6-12-3SY	OM1 62.5/125µm six SC simplex adapters to one male 12-fiber pre-terminated MTP* connector.	1	10
FC6-12-3Y	OM1 62.5/125µm six SC duplex adapters to one male 12-fiber pre-terminated MTP* connector.	1	10
FC6-6-3	OM1 62.5/125µm three SC duplex adapters to one male 12-fiber pre-terminated MTP* connector.	1	10

9/125µm (OS1/OS2) Singlemode MTP* Cassettes

FC9-12-10Y	OS1/OS2 Singlemode six LC duplex adapters to one male 12-fiber pre-terminated MTP* connector.	1	10
FC9-24-10Y	OS1/OS2 Singlemode twelve LC duplex adapters to two male 12-fiber pre-terminated MTP*connectors.	1	10
FC9-12-3SY	OS1/OS2 Singlemode six SC simplex adapters to one male 12-fiber pre-terminated MTP* connector.	1	10
FC9-12-3Y	OS1/OS2 Singlemode six SC duplex adapters to one male 12-fiber pre-terminated MTP* connector.	1	10
FC9-6-3	OS1/OS2 Singlemode three SC duplex adapters to one male 12-fiber pre-terminated MTP* connector.	1	10

For MTP* Connector Cleaning Tools, see page C.107.

*MTP is a registered trademark of US Conec Ltd.



Keyed LC QuickNet™ MTP* Fiber Optic Cassettes

- Include color-specific keys with positive and negative keying features to visually and mechanically distinguish connections to prevent unauthorized mating with unlike keyed or non-keyed connectors and patch cords
- Part of a complete keyed LC system that includes Opti-Core® Patch Cords and Pigtails, OptiCam® Pre-Polished Cam Connectors, Opticom® Fiber Adapter Panels (FAPs), and Mini-Com® Adapter Modules
- Compatible with Opticom® QuickNet™ Rack Mount Fiber Cassette Enclosures on page C.54, Opticom® Zero RU Cable Management Solutions on page C.57, and Opticom® Wall Mount Enclosures on page C.60, for up to 96 fiber connections in 1RU
- Low insertion loss of 0.5dB max. per optimized cassette and 1.0dB max. per standard cassette; ensures system meets IEEE 802.3ae max. channel loss specification of <2.6dB
- Return loss: ≥26dB (10Gig™ multimode), ≥20dB (multimode), ≥55dB (singlemode)
- Connect together with high-density female MTP* cable assemblies as interconnecting network segments for deploying a remote or data center location in minutes
- Significantly reduce installation time and labor by eliminating field connector terminations
- Factory terminated, assembled, and 100% tested
- Insertion loss data provided on every fiber cassette
- Return loss data provided on all singlemode fiber cassettes
- Lifetime traceability of test data to a Q.C. number on each fiber cassette
- 10Gig™ OM3 50/125µm Fiber Cassettes are tested per IEEE 802.3ae 10 GbE to support network transmission speeds up to 10 Gb/s for link lengths up to 300 meters at 850nm; backward compatible with all 50/125µm (OM2) MPO or MTP* system requirements



FCXO-24-10ABL



FCXO-24-10BRD

Part Number	Part Description	Key Type and Color	Std. Pkg. Qty.	Std. Ctn. Qty.
Keyed LC Optimized 10Gig™ 50/125µm (OM3) Multimode MTP* Cassettes				
FCXO-12-10ABL	Optimized OM3 10Gig™ 50/125µm Six LC (keyed A – black) duplex adapters to one male 12-fiber optimized pre-terminated MTP* connector.	Keyed A – Black	1	10
FCXO-12-10BRD	Optimized OM3 10Gig™ 50/125µm Six LC (keyed B – red) duplex adapters to one male 12-fiber optimized pre-terminated MTP* connector.	Keyed B – Red	1	10
FCXO-12-10CGR	Optimized OM3 10Gig™ 50/125µm Six LC (keyed C – green) duplex adapters to one male 12-fiber optimized pre-terminated MTP* connector.	Keyed C – Green	1	10
FCXO-12-10DYL	Optimized OM3 10Gig™ 50/125µm Six LC (keyed D – yellow) duplex adapters to one male 12-fiber optimized pre-terminated MTP* connector.	Keyed D – Yellow	1	10
FCXO-12-10EOR	Optimized OM3 10Gig™ 50/125µm Six LC (keyed E – orange) duplex adapters to one male 12-fiber optimized pre-terminated MTP* connector.	Keyed E – Orange	1	10
FCXO-12-10FDB	Optimized OM3 10Gig™ 50/125µm Six LC (keyed F – dark blue) duplex adapters to one male 12-fiber optimized pre-terminated MTP* connector.	Keyed F – Dark Blue	1	10
FCXO-24-10ABL	Optimized OM3 10Gig™ 50/125µm Twelve LC (keyed A – black) duplex adapters to two male 24-fiber optimized pre-terminated MTP* connectors.	Keyed A – Black	1	10
FCXO-24-10BRD	Optimized OM3 10Gig™ 50/125µm Twelve LC (keyed B – red) duplex adapters to two male 24-fiber optimized pre-terminated MTP* connectors.	Keyed B – Red	1	10
FCXO-24-10CGR	Optimized OM3 10Gig™ 50/125µm Twelve LC (keyed C – green) duplex adapters to two male 24-fiber optimized pre-terminated MTP* connectors.	Keyed C – Green	1	10
FCXO-24-10DYL	Optimized OM3 10Gig™ 50/125µm Twelve LC (keyed D – yellow) duplex adapters to two male 24-fiber optimized pre-terminated MTP* connectors.	Keyed D – Yellow	1	10

For MTP* Connector Cleaning Tools, see page C.107.

*MTP is a registered trademark of US Conec Ltd.

The Keyed LC Fiber Optic System is now offering 18 colors to ensure network physical layer security with color-specific keyed connectivity. For complete keyed solutions, please reference www.panduit.com.

Table continues on page C.50

Keyed LC QuickNet™ MTP* Fiber Optic Cassettes (continued)**FCX-24-10CGR**

Part Number	Part Description	Key Type and Color	Std. Pkg. Qty.	Std. Ctn. Qty.
FCXO-24-10EOR	Optimized OM3 10Gig™ 50/125µm Twelve LC (keyed E – orange) duplex adapters to two male 24-fiber optimized pre-terminated MTP* connectors.	Keyed E – Orange	1	10
FCXO-24-10FDB	Optimized OM3 10Gig™ 50/125µm Twelve LC (keyed F – dark blue) duplex adapters to two male 24-fiber optimized pre-terminated MTP* connectors.	Keyed F – Dark Blue	1	10

Keyed LC 10Gig™ 50/125µm (OM3) Multimode MTP* Cassettes

FCX-12-10ABL	OM3 10Gig™ 50/125µm Six LC (keyed A – black) duplex adapters to one male 12-fiber pre-terminated MTP* connector.	Keyed A – Black	1	10
FCX-12-10BRD	OM3 10Gig™ 50/125µm Six LC (keyed B – red) duplex adapters to one male 12-fiber pre-terminated MTP* connector.	Keyed B – Red	1	10
FCX-12-10CGR	OM3 10Gig™ 50/125µm Six LC (keyed C – green) duplex adapters to one male 12-fiber pre-terminated MTP* connector.	Keyed C – Green	1	10
FCX-12-10DYL	OM3 10Gig™ 50/125µm Six LC (keyed D – yellow) duplex adapters to one male 12-fiber pre-terminated MTP* connector.	Keyed D – Yellow	1	10
FCX-12-10EOR	OM3 10Gig™ 50/125µm Six LC (keyed E – orange) duplex adapters to one male 12-fiber pre-terminated MTP* connector.	Keyed E – Orange	1	10
FCX-12-10FDB	OM3 10Gig™ 50/125µm Six LC (keyed F – dark blue) duplex adapters to one male 12-fiber pre-terminated MTP* connector.	Keyed F – Dark Blue	1	10
FCX-24-10ABL	OM3 10Gig™ 50/125µm Twelve LC (keyed A – black) duplex adapters to two male 24-fiber pre-terminated MTP* connectors.	Keyed A – Black	1	10
FCX-24-10BRD	OM3 10Gig™ 50/125µm Twelve LC (keyed B – red) duplex adapters to two male 24-fiber pre-terminated MTP* connectors.	Keyed B – Red	1	10
FCX-24-10CGR	OM3 10Gig™ 50/125µm Twelve LC (keyed C – green) duplex adapters to two male 24-fiber pre-terminated MTP* connectors.	Keyed C – Green	1	10
FCX-24-10DYL	OM3 10Gig™ 50/125µm Twelve LC (keyed D – yellow) duplex adapters to two male 24-fiber pre-terminated MTP* connectors.	Keyed D – Yellow	1	10
FCX-24-10EOR	OM3 10Gig™ 50/125µm Twelve LC (keyed E – orange) duplex adapters to two male 24-fiber pre-terminated MTP* connectors.	Keyed E – Orange	1	10
FCX-24-10FDB	OM3 10Gig™ 50/125µm Twelve LC (keyed F – dark blue) duplex adapters to two male 24-fiber pre-terminated MTP* connectors.	Keyed F – Dark Blue	1	10

For MTP* Connector Cleaning Tools, see page C.107.

*MTP is a registered trademark of US Conec Ltd.

The Keyed LC Fiber Optic System is now offering 18 colors to ensure network physical layer security with color-specific keyed connectivity. For complete keyed solutions, please reference www.panduit.com.

Keyed LC QuickNet™ MTP* Fiber Optic Cassettes (continued)



FC5-24-10DYL

Part Number	Part Description	Key Type and Color	Std. Pkg. Qty.	Std. Ctn. Qty.
Keyed LC 50/125µm (OM2) Multimode MTP* Cassettes				
FC5-12-10ABL	OM2 50/125µm Six LC (keyed A – black) duplex adapters to one male 12-fiber pre-terminated MTP* connector.	Keyed A – Black	1	10
FC5-12-10BRD	OM2 50/125µm Six LC (keyed B – red) duplex adapters to one male 12-fiber pre-terminated MTP* connector.	Keyed B – Red	1	10
FC5-12-10CGR	OM2 50/125µm Six LC (keyed C – green) duplex adapters to one male 12-fiber pre-terminated MTP* connector.	Keyed C – Green	1	10
FC5-12-10DYL	OM2 50/125µm Six LC (keyed D – yellow) duplex adapters to one male 12-fiber pre-terminated MTP* connector.	Keyed D – Yellow	1	10
FC5-12-10EOR	OM2 50/125µm Six LC (keyed E – orange) duplex adapters to one male 12-fiber pre-terminated MTP* connector.	Keyed E – Orange	1	10
FC5-12-10FDB	OM2 50/125µm Six LC (keyed F – dark blue) duplex adapters to one male 12-fiber pre-terminated MTP* connector.	Keyed F – Dark Blue	1	10
FC5-24-10ABL	OM2 50/125µm Twelve LC (keyed A – black) duplex adapters to two male 24-fiber pre-terminated MTP* connectors.	Keyed A – Black	1	10
FC5-24-10BRD	OM2 50/125µm Twelve LC (keyed B – red) duplex adapters to two male 24-fiber pre-terminated MTP* connectors.	Keyed B – Red	1	10
FC5-24-10CGR	OM2 50/125µm Twelve LC (keyed C – green) duplex adapters to two male 24-fiber pre-terminated MTP* connectors.	Keyed C – Green	1	10
FC5-24-10DYL	OM2 50/125µm Twelve LC (keyed D – yellow) duplex adapters to two male 24-fiber pre-terminated MTP* connectors.	Keyed D – Yellow	1	10
FC5-24-10EOR	OM2 50/125µm Twelve LC (keyed E – orange) duplex adapters to two male 24-fiber pre-terminated MTP* connectors.	Keyed E – Orange	1	10
FC5-24-10FDB	OM2 50/125µm Twelve LC (keyed F – dark blue) duplex adapters to two male 24-fiber pre-terminated MTP* connectors.	Keyed F – Dark Blue	1	10

For MTP* Connector Cleaning Tools, see page C.107.

*MTP is a registered trademark of US Conec Ltd.

The Keyed LC Fiber Optic System is now offering 18 colors to ensure network physical layer security with color-specific keyed connectivity. For complete keyed solutions, please reference www.panduit.com.

Table continues on page C.52

Keyed LC QuickNet™ MTP* Fiber Optic Cassettes (continued)**FC6-24-10EOR**

Part Number	Part Description	Key Type and Color	Std. Pkg. Qty.	Std. Ctn. Qty.
Keyed LC 62.5/125µm (OM1) Multimode MTP* Cassettes				
FC6-12-10ABL	OM1 62.5/125µm Six LC (keyed A – black) duplex adapters to one male 12-fiber pre-terminated MTP* connector.	Keyed A – Black	1	10
FC6-12-10BRD	OM1 62.5/125µm Six LC (keyed B – red) duplex adapters to one male 12-fiber pre-terminated MTP* connector.	Keyed B – Red	1	10
FC6-12-10CGR	OM1 62.5/125µm Six LC (keyed C – green) duplex adapters to one male 12-fiber pre-terminated MTP* connector.	Keyed C – Green	1	10
FC6-12-10DYL	OM1 62.5/125µm Six LC (keyed D – yellow) duplex adapters to one male 12-fiber pre-terminated MTP* connector.	Keyed D – Yellow	1	10
FC6-12-10EOR	OM1 62.5/125µm Six LC (keyed E – orange) duplex adapters to one male 12-fiber pre-terminated MTP* connector.	Keyed E – Orange	1	10
FC6-12-10FDB	OM1 62.5/125µm Six LC (keyed F – dark blue) duplex adapters to one male 12-fiber pre-terminated MTP* connector.	Keyed F – Dark Blue	1	10
FC6-24-10ABL	OM1 62.5/125µm Twelve LC (keyed A – black) duplex adapters to two male 24-fiber pre-terminated MTP* connectors.	Keyed A – Black	1	10
FC6-24-10BRD	OM1 62.5/125µm Twelve LC (keyed B – red) duplex adapters to two male 24-fiber pre-terminated MTP* connectors.	Keyed B – Red	1	10
FC6-24-10CGR	OM1 62.5/125µm Twelve LC (keyed C – green) duplex adapters to two male 24-fiber pre-terminated MTP* connectors.	Keyed C – Green	1	10
FC6-24-10DYL	OM1 62.5/125µm Twelve LC (keyed D – yellow) duplex adapters to two male 24-fiber pre-terminated MTP* connectors.	Keyed D – Yellow	1	10
FC6-24-10EOR	OM1 62.5/125µm Twelve LC (keyed E – orange) duplex adapters to two male 24-fiber pre-terminated MTP* connectors.	Keyed E – Orange	1	10
FC6-24-10FDB	OM1 62.5/125µm Twelve LC (keyed F – dark blue) duplex adapters to two male 24-fiber pre-terminated MTP* connectors.	Keyed F – Dark Blue	1	10

For MTP* Connector Cleaning Tools, see page C.107.

*MTP is a registered trademark of US Conec Ltd.

The Keyed LC Fiber Optic System is now offering 18 colors to ensure network physical layer security with color-specific keyed connectivity. For complete keyed solutions, please reference www.panduit.com.

Keyed LC QuickNet™ MTP* Fiber Optic Cassettes (continued)



FC9-24-10FDB

Part Number	Part Description	Key Type and Color	Std. Pkg. Qty.	Std. Ctn. Qty.
Keyed LC 9/125µm (OS1/OS2) Singlemode Pre-Terminated MTP* Cassettes				
FC9-12-10ABL	OS1/OS2 9/125µm Six LC (keyed A – black) duplex adapters to one male 12-fiber pre-terminated MTP* connector.	Keyed A – Black	1	10
FC9-12-10BRD	OS1/OS2 9/125µm Six LC (keyed B – red) duplex adapters to one male 12-fiber pre-terminated MTP* connector.	Keyed B – Red	1	10
FC9-12-10CGR	OS1/OS2 9/125µm Six LC (keyed C – green) duplex adapters to one male 12-fiber pre-terminated MTP* connector.	Keyed C – Green	1	10
FC9-12-10DYL	OS1/OS2 9/125µm Six LC (keyed D – yellow) duplex adapters to one male 12-fiber pre-terminated MTP* connector.	Keyed D – Yellow	1	10
FC9-12-10EOR	OS1/OS2 9/125µm Six LC (keyed E – orange) duplex adapters to one male 12-fiber pre-terminated MTP* connector.	Keyed E – Orange	1	10
FC9-12-10FDB	OS1/OS2 9/125µm Six LC (keyed F – dark blue) duplex adapters to one male 12-fiber pre-terminated MTP* connector.	Keyed F – Dark Blue	1	10
FC9-24-10ABL	OS1/OS2 9/125µm Twelve LC (keyed A – black) duplex adapters to two male 24-fiber pre-terminated MTP* connectors.	Keyed A – Black	1	10
FC9-24-10BRD	OS1/OS2 9/125µm Twelve LC (keyed B – red) duplex adapters to two male 24-fiber pre-terminated MTP* connectors.	Keyed B – Red	1	10
FC9-24-10CGR	OS1/OS2 9/125µm Twelve LC (keyed C – green) duplex adapters to two male 24-fiber pre-terminated MTP* connectors.	Keyed C – Green	1	10
FC9-24-10DYL	OS1/OS2 9/125µm Twelve LC (keyed D – yellow) duplex adapters to two male 24-fiber pre-terminated MTP* connectors.	Keyed D – Yellow	1	10
FC9-24-10EOR	OS1/OS2 9/125µm Twelve LC (keyed E – orange) duplex adapters to two male 24-fiber pre-terminated MTP* connectors.	Keyed E – Orange	1	10
FC9-24-10FDB	OS1/OS2 9/125µm Twelve LC (keyed F – dark blue) duplex adapters to two male 24-fiber pre-terminated MTP* connectors.	Keyed F – Dark Blue	1	10

For MTP* Connector Cleaning Tools, see page C.107.

*MTP is a registered trademark of US Conec Ltd.

The Keyed LC Fiber Optic System is now offering 18 colors to ensure network physical layer security with color-specific keyed connectivity. For complete keyed solutions, please reference www.panduit.com.

Opticom[®] QuickNet[™] Rack Mount Fiber Cassette Enclosures

- Mount to standard EIA 19" rack rails
- Hold QuickNet[™] Fiber Optic Cassettes on pages C.44 – C.53, QuickNet[™] or Opticom[®] Fiber Adapter Panels on pages C.38 – C.43, and Opticom[®] Fiber Optic Splice Modules on page C.62
- Suitable for all pre-terminated, field terminated, or field-splice applications
- Up to four cassettes or FAPs per rack unit for maximum patch field density
- Slide-out, tilt-down drawer provides full front access to all fibers and cables
- Integral bend radius control and cable management for fiber optic patch cords
- Innovative rear cable management for proper slacking/spooling of trunk cable break-outs and interconnect cables
- Multiple trunk cable entry locations
- Include fiber optic cable routing kit (grommets, cable ties, spools, strain relief bracket, and ID/caution labels) for various cable management solutions

**FCE1U****FCE2U****FCE4U**

Part Number	Part Description	No. of Rack Spaces [^]	Std. Pkg. Qty.
FCE1U	Holds up to four QuickNet [™] Cassettes, FAP adapter panels, or FOSM splice modules. Dimensions: 1.73"H x 17.60"W x 16.30"D (43.9mm x 447.0mm x 414.0mm)	1	1
FCE1UA	Open access version of FCE1U enclosure. Holds up to four QuickNet [™] Cassettes, FAP adapter panels, or FOSM splice modules. Dimensions: 1.73"H x 17.60"W x 16.30"D (43.9mm x 447.0mm x 414.0mm)	1	1
FCE2U	Holds up to eight QuickNet [™] Cassettes, FAP adapter panels, or FOSM splice modules. Dimensions: 3.48"H x 17.60"W x 16.30"D (88.4mm x 447.0mm x 414.0mm)	2	1
FCE4U	Holds up to twelve QuickNet [™] Cassettes, FAP adapter panels, or FOSM splice modules. Dimensions: 6.98"H x 17.60"W x 16.30"D (177.0mm x 447.0mm x 414.0mm)	4	1

[^]One rack space = 1.75" (44.5mm).

Opticom® Rack Mount Fiber Enclosures

- Mount to standard 19" or 23" EIA rack or cabinet
- Hold QuickNet™ or Opticom® Fiber Adapter Panels (FAPs) on pages C.38 – C.43, and Opticom® Fiber Optic Splice Modules on page C.62
- Front and rear access on all models via durable molded-hinge doors
- Integral bend radius control and cable management for fiber patch cords
- Multiple trunk cable entry locations
- Include fiber optic cable routing kit (grommets, cable ties, saddle clips, strain relief bracket, and ID/caution labels) for various cable management solutions



FRME1U



FRME2U



FRME3



FRME4

Part Number	Part Description	No. of Rack Spaces [^]	Std. Pkg. Qty.
FRME1U	Holds up to three FAP or FMP adapter panels or FOSM splice modules. Bidirectional sliding drawers provides front and rear access to fibers. Dimensions: 1.74"H x 17.00"W x 14.20"D (44.0mm x 432.0mm x 361.0mm)	1	1
FRME2U	Holds up to six FAP or FMP adapter panels or FOSM splice modules. Bidirectional sliding drawers provides front and rear access to fibers. Dimensions: 3.48"H x 17.00"W x 14.20"D (88.0mm x 432.0mm x 361.0mm)	2	1
FRME3	Holds up to nine FAP or FMP adapter panels. Fixed bulkhead design. Dimensions: 5.00"H x 17.16"W x 11.80"D (127.0mm x 433.3mm x 292.1mm)	3	1
FRME4	Holds up to twelve FAP or FMP adapter panels. Fixed bulkhead design. Dimensions: 6.62"H x 17.16"W x 11.80"D (168.1mm x 433.3mm x 292.1mm)	4	1

[^]One rack space = 1.75" (44.45mm).
Optional locks available for rack mount enclosures.
All product color is black.

Opticom[®] Rack Mount Fiber Trays

- Mount to standard EIA 19" rack rails
- Standard front or angled front options
- Use with Opticom[®] Fiber Adapter Patch Panels (below) to protect fibers and terminations
- Can be used as a back box for select Mini-Com[®] Patch Panels
- Removable top cover provides access to connections, fibers, and slack storage in rear of tray
- Multiple trunk cable entry locations provided on rear and sides of enclosure
- Include fiber optic cable routing kit (grommets, cable ties, spools, strain relief bracket and ID/caution labels) for various cable management solutions
- For fiber optic splicing solutions see page C.67



FMT1



FMT2



FMT1A



FMT2A

Part Number	Part Description	No. of Rack Spaces [^]	Std. Pkg. Qty.
Standard Fiber Mount Trays			
FMT1	Mount with CFAPPBL1 fiber adapter patch panel to hold up to four QuickNet™ Cassettes, FAP, and FMP adapter panels. Dimensions: 1.75"H x 17.16"W X 11.16"D (44.4mm x 433.3mm x 283.5mm)	1	1
FMT2	Mount with CFAPPBL2 fiber adapter patch panel to hold up to eight QuickNet™ Cassettes, FAP, or FMP adapter panels. Dimensions: 3.48"H x 17.16"W x 11.16"D (88.3mm x 433.3mm x 283.5mm)	2	1

Angled Fiber Mount Trays			
FMT1A	Mount with CFAPPBL1A angled fiber adapter patch panel to hold up to four FAP or FMP adapter panels. Dimensions: 1.75"H x 17.16"W X 11.16"D (44.4mm x 433.3mm x 283.5mm)	1	1
FMT2A	Mount with CFAPPBL2A angled fiber adapter patch panel to hold up to eight FAP or FMP adapter panels. Dimensions: 3.48"H x 17.16"W x 11.16"D (88.3mm x 433.3mm x 283.5mm)	2	1

[^]One rack space = 1.75" (44.45mm).
All product color is black.

Opticom[®] Fiber Adapter Patch Panels

- Mount to standard EIA 19" rack rails
- Standard version holds both QuickNet™ Fiber Optic Cassettes and Opticom[®] Fiber Adapter Panels
- Angled version holds Opticom[®] Fiber Adapter Panels and matches Mini-Com[®] Angled Patch Panel profile
- Use with Opticom[®] Rack Mount Fiber Trays (above) to protect fibers and terminations

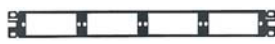

CFAPPBL1



CFAPPBL2



CFAPPBL1A



CFAPPBL2

Part Number	Part Description	No. of Rack Spaces [^]	Std. Pkg. Qty.
Standard Fiber Adapter Patch Panels			
CFAPPBL1	Flat fiber patch panel. Holds up to four FAP or FMP adapter panels.	1	1
CFAPPBL2	Flat fiber patch panel. Holds up to eight FAP or FMP adapter panels.	2	1
Angled Fiber Adapter Patch Panels			
CFAPPBL1A	Angled fiber patch panel. Holds up to four FAP or FMP adapter panels.	1	1
CFAPPBL2A	Angled fiber patch panel. Holds up to eight FAP or FMP adapter panels.	2	1

[^]One rack space = 1.75" (44.45mm).
All product color is black.

Opticom® Zero RU Cable Management Solutions

- Mount directly to rack or enclosure to provide location, connection, and quick deployment of QuickNet™ or Opticom® Fiber Adapter Panels (pages C.39 – C.43) or QuickNet™ MTP* Cassettes (pages C.47 – C.53) without using additional rack space

- Can be used with QuickNet™ MPO/MTP* Fiber Adapter Panels on page C.31 and QuickNet™ Hydra Cable Assemblies on page C.91 to facilitate connection to the active equipment
- Angled bracket includes adhesive foam tape and magnetic strip for mounting to rack
- Standard straight bracket screws directly to rack or enclosure



FEABRUA



FEABRU



FQCBRUA



FQCRCM



FPFPC1

Part Number	Part Description	Std. Pkg. Qty.	Std. Ctn. Qty.
FEABRUA	Zero RU adhesive or magnetic mount 90° angle fiber enclosure adapter panel bracket.	1	10
FEABRU	Zero RU screw mount fiber enclosure adapter panel bracket.	1	10
FQCBRUA	QuickNet™ Zero RU Bracket accepts up to two fiber QuickNet™ SFQ cassettes or up to two QuickNet™ pre-terminated copper cassettes without occupying RU space. Mounts to any EIA-310-D compliant rack rail.	1	—
FQCRCM	QuickNet™ Cassette Rear Cable Manager manages up to one meter of slack for each of 16 MTP* Interconnect Cables in support of QuickNet™ SFQ Cassettes, QuickNet™ HDQ Cassettes, or QuickNet™ MTP Cassettes. <i>Intended for Panduit® 2-Post Racks ONLY. Not intended for 4-post racks, server cabinets or network cabinets.</i>	1	10











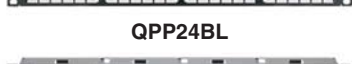
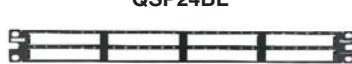

QuickNet™ Fiber Patch Field Protection Cover

FPFPC1	1RU Fiber Patch Field Protection Cover protects front patch field, minimizing potential for connector damage and fiber attenuation. Includes a labeling card for identification of ports and D-rings to provide physical support to fiber and control bend radius. <i>Not compatible with Opticom® Angled and QuickNet™ Angled Patch Panels</i>	1	10
--------	---	---	----

*MTP is a registered trademark of US Conec Ltd.

QuickNet™ Patch Panels and Accessories

- Accept QuickNet™ Copper Cable Assemblies and QuickNet™ SFQ Series MTP* Fiber Optic Cassettes which snap in and out with one hand
- High-density patch panels conserve valuable rack space
- Angled patch panels facilitate proper bend radius control and minimize the need for horizontal cable managers
- All metal patch panels accept shielded cassettes, no additional grounding kit required
- Pre-printed numbers above each port for easy identification
- Mount to standard EIA 19" racks or 23" racks with optional extender brackets
- Zero RU brackets accept fiber adapter panels or pre-terminated cassettes by mounting directly to rack or enclosure without utilizing additional rack space
- Optional patch panel adapter (QPPABL) accepts all Mini-Com® Modules for UTP, fiber optic, and audio/visual applications
- Optional patch panel blank (QPPBBL) promotes proper airflow and cooling
- Label/label cover kit (QPPLC24) provides port and panel identification for 24-port patch panels
- Optional retrofit grounding kit (QNSMRRT) required to ground shielded cassettes to QuickNet™ Modular Patch Panels
- QuickNet™ All Metal Modular Patch Panels accept shielded cassettes, with no additional grounding kit required

Part Number	Part Description	No. of Rack Spaces [^]	Std. Pkg. Qty.	Std. Ctn. Qty.
QuickNet™ Angled Patch Panels				
 QAPP24BL	24-port angled patch panel which accepts QuickNet™ Pre-Terminated Cassettes and Patch Panel Adapters.	1	1	10
 QASP24BL	24-port, all metal angled patch panel which accepts QuickNet™ Pre-Terminated Shielded Cassettes and Patch Panel Adapters.	1	1	10
 QAPP48HDBL	48-port angled patch panel which accepts QuickNet™ Pre-Terminated Cassettes and Patch Panel Adapters.	1	1	10
 QAPP48HDVNSBL	48-port angled patch panel which accepts QuickNet™ Pre-Terminated Cassettes and Patch Panel Adapters. Numbering sequence is top to bottom across patch panel.	1	1	10
 QASP48HDBL	48-port, all metal angled patch panel which accepts QuickNet™ Pre-Terminated Shielded Cassettes and Patch Panel Adapters.	1	1	10
QuickNet™ Flat Patch Panels				
 QPP24BL	24-port patch panel which accepts QuickNet™ Pre-Terminated Cassettes and Patch Panel Adapters.	1	1	10
 QSP24BL	24-port, all metal patch panel which accepts QuickNet™ Pre-Terminated Shielded Cassettes and Patch Panel Adapters.	1	1	10
 QPP48HDBL	48-port patch panel which accepts QuickNet™ Pre-Terminated Cassettes and Patch Panel Adapters.	1	1	10
 QPP48HDVNSBL	48-port patch panel which accepts QuickNet™ Pre-Terminated Cassettes and Patch Panel Adapters. Numbering sequence is top to bottom across patch panel.	1	1	10
Patch Panel Adapter				
 QPPABL	QuickNet™ Patch Panel Adapter which accepts Mini-Com® Modules for UTP, fiber optic, and audio/visual applications.	—	1	10
 QSP48HDBL	48-port, all metal patch panel which accepts QuickNet™ Pre-Terminated Shielded Cassettes and Patch Panel Adapters.	1	1	10
Patch Panel Blank				
 QPPBBL	QuickNet™ Patch Panel Blank reserves space for future use and promotes proper airflow and cooling.	—	1	10
Patch Panel Label Kit				
 QPPLC24	Label/label cover kit for 24-port QuickNet™ Patch Panels. Each kit contains four labels and four clear label covers per bag.	—	1	10

MTP is a registered trademark of US Conec Ltd. ^One rack space = 1.75" (44.45mm). M6 and #12-24 mounting screws included. QuickNet™ Pre-Terminated Cable Assemblies available on pages B.4 – B.5. QuickNet™ SFQ Series MTP Fiber Optic Cassettes available on page C.51.



Mini-Com® Modular Faceplate Patch Panels

- Angled patch panels facilitate proper bend radius control and minimize the need for horizontal cable managers
- Accept Mini-Com® Modules for fiber optic, UTP, and audio/video, which snap in and out for easy moves, adds, and changes
- Label versions available for easy port identification; replacement label/label covers available
- Mount to standard EIA 19" racks or 23" racks with optional extender brackets on page L.40



CPPLA24WBLY

PATENTED



CPPLA48WBLY



CPPL24WBLY



CPPL48WBLY



C4PPLK

Part Number	Part Description	No. of Rack Spaces [^]	Std. Pkg. Qty.	Std. Ctn. Qty.
-------------	------------------	---------------------------------	----------------	----------------

Mini-Com® Angled Modular Patch Panels with Labels

CPPLA24WBLY	24-port angled patch panel with labels, supplied with six factory installed CFFPL4 type front removable snap-in faceplates.	1	1	10
CPPLA48WBLY	48-port angled patch panel with labels, supplied with twelve factory installed CFFPL4 type front removable snap-in faceplates.	2	1	10

Mini-Com® Modular Patch Panels with Labels

CPPL24WBLY	24-port patch panel with labels, supplied with six factory installed CFFPL4 type front removable snap-in faceplates.	1	1	10
CPPL48WBLY	48-port patch panel with labels, supplied with twelve factory installed CFFPL4 type front removable snap-in faceplates.	2	1	10

Replacement Labels for Mini-Com® Modular Patch Panels

C4PPLK	Replacement label/label cover kit for Mini-Com® Modular Patch Panels with Labels (CPPL24WBLY, CPPL48WBLY, CPPL24WRBLY, CPPL48WRBLY) and Mini-Com® Modular Furniture Faceplates with Labels (CFFPL4, CFFHSL4, CFFPEBSL4). Each kit contains six labels and six clear label covers per bag.	—	1	10
--------	---	---	---	----

[^] One rack space = 1.75" (44.45mm).
M6 and #12-24 mounting screws included.

Component Labels for Mini-Com® Modular Faceplate Patch Panels



Suggested Label Solutions for TIA/EIA-606-A Compliance

Patch Panel Part Number	Laser/Ink Jet Desktop Printer Label	TDP43ME Thermal Transfer Desktop Printer Label	PanTher™ LS8E Hand-Held Printer Label	Cougar™ LS9 Hand-Held Printer Label
All Patch Panels on this Page	C261X035Y1J	C261X035Y1T	C261X035Y1C	T038X000FJC-BK‡

For complete labeling solutions and product information, reference charts on pages O.1 – O.18.

‡For non-adhesive labeling solution, do not remove liner from label.

Opticom[®] Wall Mount Enclosures

- Holds Opticom[®] Fiber Adapter Panels (FAPs)
- Rugged all metal construction for fiber protection and secure mounting
- Compact design allows installation in tight areas
- Separate doors for service side and user side with optional keyed locks for added security
- Include fiber optic cable routing kit (grommets, cable ties, spools, strain relief bracket and ID/caution labels) for various cable management solutions

**FWME2****FWME4****FWME8**

Part Number	Part Description	Std. Pkg. Qty.
-------------	------------------	----------------

Fiber Wall Mount Enclosures

FWME2	Holds up to two QuickNet™ Cassettes, FAP, or FMP panels. Dimensions: 12.00"W x 10.18"H x 2.32"D (304.8mm x 258.6mm x 59.1mm)	1
FWME4	Holds up to four QuickNet™ Cassettes, FAP, or FMP panels. Dimensions: 16.11"W x 12.25"H x 3.52"D (409.2mm x 311.0mm x 89.4mm)	1
FWME8	Holds up to eight QuickNet™ Cassettes, FAP, or FMP panels. Dimensions: 16.11"W x 16.11"H x 5.00"D (409.2mm x 409.2mm x 127.0mm)	1

Fiber Accessories

FELS	Fiber enclosure lock for service side.	1
FELU	Fiber enclosure lock for user side.	1

All product color is black.

*MTP is a registered trademark of US Conec Ltd.

Opticom® Fiber Slack Management Accessories

- Slack management and cable routing accessories for use in Opticom® Rack Mount and Wall Mount Fiber Enclosures

- Maintain minimum bend radius and ensure proper cable management
- Smooth rounded edges on all surfaces eliminate potential for snagging and stress on fiber optic cables



FMS1



FMS2



FMSS



FEBRC



FMFIN

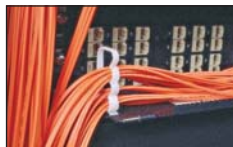

VWS106



VWSDC

Part Number	Part Description	Std. Pkg. Qty.	Std. Ctn. Qty.
Fiber Slack Management Spools			
FMS1	Spools and manages fiber slack in Opticom® 1RU Rack Mount Fiber Enclosures. Features fiber retention tabs and fingers. Comes with two spools and adhesive mounts. Dimensions: 1.00"H x 4.00" dia. (25.4mm x 100.0mm)	1	10
FMS2	Spools and manages fiber slack in Opticom® 2RU or 4RU Rack Mount Fiber Enclosures. Features fiber retention tabs and fingers. Comes with two spools and adhesive mounts. Dimensions: 1.60"H x 4.00" dia. (40.6mm x 100.0mm)	1	10
FMSS	Top-hat style fiber slack spool for Opticom® Wall Mount Enclosures. Single spool with adhesive mount. Dimensions: 1.25"H x 2.50" dia. spool, 3.25" dia. flange (31.8mm x 63.5mm spool, 82.6mm flange)	1	10
Bend Radius Control Accessories			
FEBRC	Fiber enclosure bend radius control clip for use with Opticom® 1RU and 2RU Rack Mount Enclosures. Maintains proper bend radius control of fiber patch cords from patch field to vertical fiber manager; includes two bend radius control clips. Dimensions: 1.50"H x .09"W x 3.10"D (79.8mm x 21.8mm x 39.1mm)	1	—
FMFIN	Fiber manager fin; individual fiber management fin with NyLatch fastener for attachment to FCE4U Opticom® Fiber Cassette Enclosure front patch cord manager. Dimensions: 3.60"H x 1.00" dia. (92.1mm x 25.4mm)	1	—
PZBR3.5	Bend Radius Post Kit for use with FCE4U Opticom® Fiber Cassette Enclosure; 3.5" (89mm) long. Maintains proper bend radius control of fiber patch cords within patch field; includes two bend radius posts and hardware.	1	10
Accessories For Rack Mount Enclosures			
VWS106-C	Single saddle clip for fiber slack management and fiber patch cord routing. Accepts up to 1.06" dia (26.9mm) cable bundle. Nylon 6.6 material, natural color. Push mount into 0.18" (4mm) pre-drilled holes in Opticom® Fiber Enclosures.	100	500
VWSDC-C	Dual saddle clip for fiber slack management and fiber patch cord routing. Accepts two cable bundles up to 1.06" dia (26.9mm) each. Nylon 6.6 material, natural color. Push mount into 0.18" (4mm) pre-drilled holes in Opticom® Fiber Enclosures.	100	500

Opticom[®] Splice Modules, Trays, and Holders**FOSMF****FST24****FST6****FSTK****FSC24**

Part Number	Part Description	Std. Pkg. Qty.	Std. Ctn. Qty.
Fiber Optic Splice Modules			
FOSMF	Fiber optic splice module holds and protects up to 24 fusion splices. Self-stacking modules with integral cable management and fiber slacking/spooling features. Black plastic base and clear plastic hinged cover. For use with Panduit Opticom [®] FCE [®] U, FRME [®] U, and FMT series enclosures. Dimensions: 0.30"H x 14.03"W x 5.28"D (7.6mm x 356.4mm x 134.1mm)	1	10
FOSMM	Fiber optic splice module holds and protects up to 12 mechanical splices. Self-stacking modules with integral cable management and fiber slacking/spooling features. Black plastic base and clear plastic hinged cover. For use with Panduit Opticom [®] FCE [®] U, FRME [®] U, and FMT series enclosures. Dimensions: 0.30"H x 14.03"W x 5.28"D (7.6mm x 356.4mm x 134.1mm)	1	10
FOSMH1U	Fiber optic splice module holder, 1 RU. Holds up to four FOSM splice modules. For use with FCE1U or FCE1UA fiber cassette enclosure. Dimensions: 1.41"H x 0.72"W x 2.61"D (35.9mm x 18.3mm x 66.4mm)	1	10
FOSMH2U	Fiber optic splice module handler, 2 RU. Holds up to eight FOSM splice modules. For use with FCE2U fiber cassette enclosure. Dimensions: 2.91"H x 0.72"W x 2.61"D (74.0mm x 18.3mm x 66.4mm)	1	10
FOSMH4U	Fiber optic splice module holder, 4 RU. Holds up to twelve FOSM splice modules. For use with FCE4U fiber cassette enclosure. Dimensions: 5.50"H x 10.42"W x 5.41"D (139.7mm x 264.7mm x 137.4mm)	1	0
Metal Splice Tray and Holder – 24-Splice Increment			
FST24	Fiber splice tray kit for up to 24 mechanical or fusion splices or 144 ribbon fusion splices. Fits in Panduit FRME3 and FRME4 rack mount enclosures. Stacks up to three high using FST24H3 stacking unit. Dimensions: 0.37"H x 4.38"W x 11.75"L (9.4mm x 111.3mm x 298.5mm)	1	10
FST24H3	Stacking holder for FST24 fiber splice tray with built in fiber spooling. Holds and secures one to three splice trays with Panduit [®] Tak-Ty [®] Cable Ties. Mounting hardware included. For use with FRME3 and FRME4 rack mount enclosures. Dimensions: 2.07"H x 4.56"W x 11.61"L (52.6mm x 115.8mm x 294.9mm)	1	10
Metal Splice Tray and Holder – 12-Splice Increment			
FST6	Fiber splice tray kit for up to twelve mechanical or fusion splices. Fits in Panduit FMT, FWME4, and FWME8 series enclosures. Stack up to four high using FSTHE stacking unit in rack mount enclosures or using FST6H4 stacking unit in wall mount enclosures. Dimensions: 0.40"H x 4.42"W x 7.90"L (10.2mm x 112.3mm x 200.7mm)	1	10
FSTHE	Stacking holder for FST6 fiber splice tray. Holds and secures one to four splice trays (FST6) with Panduit [®] Tak-Ty [®] Cable Ties. Mount with included adhesive strips or mounting screws. Dimensions: 1.75"H x 4.56"W x 8.06"L (44.5mm x 115.8mm x 204.7mm)	1	10
Metal Splice Tray and Holder – 6-Splice Increment			
FSTK	Fiber splice tray kit for up to six mechanical or fusion splices. Stack up to two high using FSTHS stacking holder. For use in FWME2 wall mount enclosure. Dimensions: 0.40"H x 3.40"W x 6.60"L (10.2mm x 86.4mm x 167.6mm)	1	10
FSTHS	Stacking holder for FSTK fiber splice tray with built-in fiber spooling. Holds and secures one/two splice tray(s) with Panduit [®] Tak-Ty [®] Cable Ties. Mount with existing enclosure hardware. For use in FWME2 wall mount enclosure. Dimensions: 1.62"H x 3.50"W x 6.50"L (41.1mm x 88.9mm x 167.6mm)	1	10
Fiber Splice Chip			
FSC24	Accommodates and protects up to 24 fusion splices. Comes with label, clear cover, and adhesive mount. For use with any Panduit [®] Opticom [®] Enclosure. Dimensions: 0.50"H x 3.12"W x 2.47"D (12.7mm x 79.4mm x 62.7mm)	1	10

Opti-Core® 50/125µm (OM3/OM4) Patch Cords and Pigtails

- Available in riser (OFNR) or plenum (OFNP) flame ratings; part numbers listed are for OFNR (FXE10-10M1Y)
- For OFNP, place a P after the X in the part number and drop the Y (FXPE10-10M1)
- Patch cords are tested to support network transmission speeds up to 10 Gb/s for link lengths up to 300 meters with an 850nm source per IEEE 802.3ae 10 GbE standard
- Pass all TIA/EIA-568-B.3 performance requirements
- LC and SC connector housing and boot colors follow TIA/EIA-568-C.3 suggested color identification scheme
- Insertion loss per connection: 0.10dB typical; 0.30dB maximum
- Backward compatible for use with all 50/125µm system requirements
- Factory terminated and 100% tested for insertion loss
- Insertion loss data recorded for every multimode patch cord
- Lifetime traceability of test data to a Q.C. number on each patch cord
- Highest quality flame retardant fiber optic cable with tight-buffered coating on each optical fiber
- Patch cords are tested to support network transmission speeds up to 10 Gb/s for link lengths up to 550 meters with an 850nm source per IEEE 802.3ae 10 GbE standard



FZE10-10M*



FXF10-10M*



FZB10-NM*

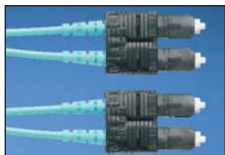

FZD3-3M*



FZB3-NM*



FXD6P-6PM*Y



FXD6J-NM*Y

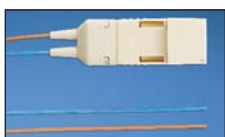

FXB6J-NM*Y

Part Number	Part Description	Length (m) [^]	Std. Pkg. Qty.	Std. Ctn. Qty.
LC to LC– OM4 Multimode Duplex Patch Cords– 1.6mm Jacketed Cable				
FZE10-10M1	LC to LC Patch Cord, Standard OM4, Riser, 0.25 dB IL Loss, Duplex, 1.6mm jacketed cable, 1m	1	1	10
LC to Pigtail– OM4 Multimode Simplex Pigtails– 900µm Buffered Fiber				
FZB10-NM1	LC to Pigtail Patch Cord, Standard OM4, Riser, 0.25 dB IL Loss, Simplex Pigtails, 900µm Buffered Fiber, 1m	1	1	10
SC to SC– OM4 Multimode Duplex Patch Cords– 3mm Jacketed Cable				
FZD3-3M1	SC to SC Patch Cord, Standard OM4, Riser, 0.25 dB IL Loss, Duplex, 3.0mm jacketed cable, 1m	1	1	10
SC to Pigtail– OM4 Multimode Simplex Pigtails– 900µm Buffered Fiber				
FZB3-NM1	SC to Pigtail Patch Cord, Standard OM4, Riser, 0.25 dB IL Loss, Simplex Pigtails, 900µm Buffered Fiber, 1m	1	1	10
SC to LC– OM4 Multimode Duplex Patch Cords– 1.6mm Jacketed Cable				
FZE3-10M1	SC to LC Patch Cord, Standard OM4, Riser, 0.25 dB IL Loss, Duplex, 1.6mm jacketed cable, 1m	1	1	10
LC to LC– OM3 Multimode Duplex Patch Cords– 1.6mm Jacketed Cable				
FXE10-10M1Y	LC to LC multimode duplex patch cord, 1.6mm jacketed cable (two duplex LC connectors on each end) – 10Gig™ 50/125µm.	1	1	10
LC to Pigtail– OM3 Multimode Simplex Pigtails– 900µm Buffered Fiber				
FXB10-NM1Y	LC to pigtail multimode simplex pigtail, 900µm buffered fiber (one LC connector on one end and open on the other end) – 10Gig™ 50/125µm.	1	1	10
SC to SC– OM3 Multimode Duplex Patch Cords– 3mm Jacketed Cable				
FXD3-3M1Y	SC to SC multimode duplex patch cord, 3mm jacketed cable (one duplex SC connector on each end) – 10Gig™ 50/125µm.	1	1	10
SC to Pigtail– OM3 Multimode Simplex Pigtails – 900µm Buffered Fiber				
FXB3-NM1Y	SC to pigtail multimode simplex pigtail, 900µm buffered fiber (one SC connector on one end and open on the other end) – 10Gig™ 50/125µm.	1	1	10
FJ® Plug to FJ® Plug – OM3 Multimode Duplex Patch Cords – 3mm Jacketed Cable				
FXD6P-6PM1Y	FJ® Plug to FJ® Plug multimode duplex patch cord, 3mm jacketed cable (one FJ® plug on each end) – 10Gig™ 50/125µm.	1	1	10
FJ® Jack Module to Pigtail – OM3 Multimode Duplex Patch Cords – 3mm Jacketed Cable				
FXD6J-NM1Y	FJ® Jack Module to pigtail multimode duplex pigtail, 3mm jacketed cable (one FJ® Jack Module on one end and open on the other end) – 10Gig™ 50/125µm.	1	1	10
FJ® Jack Module to Pigtail – OM3 Multimode Duplex Pigtails – 900µm Buffered Fiber				
FXB6J-NM1Y	FJ® Jack Module to pigtail multimode duplex pigtail, 900µm buffered fiber (one FJ® Jack Module on one end and open on the other end) – 10Gig™ 50/125µm.	1	1	10

[^]Additional lengths and availability: Patch cords are available in 1 – 10 meter lengths in 1 meter increments, and 15, 20, 25 and 30 meter lengths. Pigtails are available in 1, 2, and 3 meter lengths. To order lengths other than 1 meter, replace the 1 after the M (FXD3-3M1Y) with the desired length (FXD3-3M2Y for 2 meter length). The above lengths are stock items. For other lengths, contact Customer Service for actual lead times.

For optimized OM3 or OM4 patch cords, add an "O" after the "X" or "Z" in the part number. (ex: FZOE10-10M)

Table continues on page C.64

Opti-Core[®] 50/125µm (OM3/OM4) Patch Cords and Pigtails (continued)

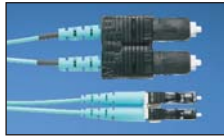

FZE3-10M*

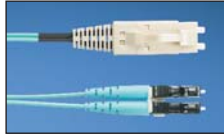

FXE6P-10M*Y

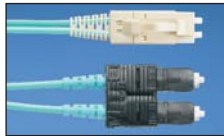

FXD6P-3M*Y

Part Number	Part Description	Length (m) [^]	Std. Pkg. Qty.	Std. Ctn. Qty.
SC to LC – OM3 Multimode Duplex Patch Cords – 1.6mm Jacketed Cable				
FZE3-10M1Y	SC to LC multimode duplex patch cord, 1.6mm jacketed cable (one duplex SC connector on one end and one duplex LC connector on the other end) – 10Gig™ 50/125µm.	1	1	10
FJ[®] Plug to LC – OM3 Multimode Duplex Patch Cords – 1.6mm Jacketed Cable				
FXE6P-10M1Y	FJ [®] Plug to LC multimode duplex patch cord, 1.6mm jacketed cable (one FJ [®] Plug on one end and one duplex LC connector on the other end) – 10Gig™ 50/125µm.	1	1	10
FJ[®] Plug to SC – OM3 Multimode Duplex Patch Cords – 3mm Jacketed Cable				
FXD6P-3M1Y	FJ [®] Plug to SC multimode duplex patch cord, 3mm jacketed cable (one FJ [®] Plug on one end and one duplex SC connector on the other end) – 10Gig™ 50/125µm.	1	1	10

[^]Additional lengths and availability: Patch cords are available in 1 – 10 meter lengths in 1 meter increments, and 15, 20, 25 and 30 meter lengths. Pigtails are available in 1, 2, and 3 meter lengths. To order lengths other than 1 meter, replace the 1 after the M (FXD3-3M1Y) with the desired length (FXD3-3M2Y for 2 meter length). The above lengths are stock items. For other lengths, contact Customer Service for actual lead times.

For optimized OM3 or OM4 patch cords, add an "O" after the "X" or "Z" in the part number. (ex: FZOE10-10M)

Cable Self-Laminating Labels for Opti-Core[®] 50/125µm (OM3) Fiber Optic Patch Cords and Pigtails



Suggested Label Solutions for TIA/EIA-606-A Compliance

Patch Cord Part Number	Laser/Ink Jet Desktop Printer Label	TDP43ME Thermal Transfer Desktop Printer Label	PanTher™ LS8E Hand-Held Printer Label	Cougar™ LS9 Hand-Held Printer Label
All FZE/FXE parts	S100X160YAJ and NWSLC-3Y‡	S100X150VATY and NWSLC-3Y‡	S100X160VAC and NWSLC-3Y‡	T100X000CBC-BK and NWSLC-3Y
All FZD/FXD parts	S100X220YAJ and NWSLC-7Y‡	S100X225VATY and NWSLC-7Y‡	S100X220VAC and NWSLC-7Y‡	T100X000CBC-BK and NWSLC-7Y

For complete labeling solutions and product information, reference charts on pages O.1 – O.18.

‡For complete information on fiber optic cable identification solutions, reference page C.92.

Opti-Core® Multimode 62.5/125µm (OM1) or 50/125µm (OM2) Fiber Optic Patch Cords and Pigtails‡

- Available in riser (OFNR) or plenum (OFNP) flame ratings; part numbers listed are for OFNR (F6E10-10M1Y)
- For OFNP, place a P after the 6 (or 5) in the part number and drop the Y (F6PE10-10M1)
- Pass all TIA/EIA-568-B.3 performance requirements
- LC and SC connector housing and boot colors follow TIA/EIA-568-C.3 suggested color identification scheme
- Insertion loss per connection: 0.10dB typical; 0.30dB maximum
- Factory terminated and 100% tested for insertion loss
- Insertion loss data recorded for every multimode patch cord
- Lifetime traceability of test data to a Q.C. number on each patch cord
- Highest quality flame retardant fiber optic cable with tight-buffered coating on each optical fiber
- To order standard 50/125µm performance (orange cable) patch cords, replace the 6 in the part number (F6D3-3M1) with a 5 (F5D3-3M1)



F6E10-10M*Y



F6F10-10M*Y



F6B10-NM*Y

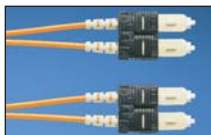

F6D3-3M*Y



F6S3-3M*Y



F6B3-NM*Y



F6D2-2M*Y



F6S2-2M*Y



F6D6P-6PM*Y

Part Number	Part Description	Length (m) [^]	Std. Pkg. Qty.	Std. Ctn. Qty.
LC to LC – OM1 Multimode Duplex Patch Cords – 1.6mm Jacketed Cable				
F6E10-10M1Y	LC to LC multimode duplex patch cord, 1.6mm jacketed cable (one duplex LC connector on each end) – 62.5/125µm.	1	1	10
LC to LC – OM1 Multimode Simplex Patch Cords – 1.6mm Jacketed Cable				
F6F10-10M1Y	LC to LC multimode simplex patch cord, 1.6mm jacketed cable (one LC connector on each end) – 62.5/125µm.	1	1	10
LC to Pigtail – OM1 Multimode Simplex Pigtails – 900µm Buffered Fiber				
F6B10-NM1Y	LC to pigtail multimode simplex pigtail, 900µm buffered fiber (one LC connector on one end and open on the other end) – 62.5/125µm.	1	1	10
SC to SC – OM1 Multimode Duplex Patch Cords – 3mm Jacketed Cable				
F6D3-3M1Y	SC to SC multimode duplex patch cord, 3mm jacketed cable (one duplex SC connector on each end) – 62.5/125µm.	1	1	10
SC to SC – OM1 Multimode Simplex Patch Cords – 3mm Jacketed Cable				
F6S3-3M1Y	SC to SC multimode simplex patch cord, 3mm jacketed cable (one SC connector on each end) – 62.5/125µm.	1	1	10
SC to Pigtail – OM1 Multimode Simplex Pigtails – 900µm Buffered Fiber				
F6B3-NM1Y	SC to pigtail multimode simplex pigtail, 900µm buffered fiber (one SC connector on one end and open on the other end) – 62.5/125µm.	1	1	10
ST to ST – OM1 Multimode Duplex Patch Cords – 3mm Jacketed Cable				
F6D2-2M1Y	ST to ST multimode duplex patch cord, 3mm jacketed cable (two ST connectors on each end) – 62.5/125µm.	1	1	10
ST to ST – OM1 Multimode Simplex Patch Cords – 3mm Jacketed Cable				
F6S2-2M1Y	ST to ST multimode duplex patch cord, 3mm jacketed cable (two ST connectors on each end) – 62.5/125µm.	1	1	10
FJ® Plug to FJ® Plug – OM1 Multimode Duplex Patch Cords – 3mm Jacketed Cable				
F6D6P-6PM1Y	FJ® Plug to FJ® Plug multimode duplex patch cord, 3mm jacketed cable (one FJ® Plug on each end) – 62.5/125µm.	1	1	10
FJ® Jack Module to Pigtail – OM1 Multimode Duplex Pigtails – 3mm Jacketed Cable				
F6D6J-NM1Y	FJ® Jack Module to pigtail multimode duplex patch cord, 3mm jacketed cable (one FJ® Jack Module on one end and open on the other end) – 62.5/125µm.	1	1	10

‡To order standard OM2 50/125µm performance (orange cable) patch cords, replace the 6 in the part number (F6D3-3M1) with a 5 (F5D3-3M1).

[^]Additional lengths and availability: Patch cords are available in 1 – 10 meter lengths in 1 meter increments, and 15, 20, 25 and 30 meter lengths. Pigtails are available in 1, 2, and 3 meter lengths. To order lengths other than 1 meter, replace the 1 after the M (F6D3-3M1Y) with the desired length (F6D3-3M2Y for 2 meter length). The above lengths are stock items. For other lengths or male MT-RJs, contact Customer Service for actual lead times.



F6D6J-NM*Y

Table continues on page C.66

Opti-Core® Multimode 62.5/125µm (OM1) or 50/125µm (OM2) Fiber Optic Patch Cords and Pigtails‡ (continued)

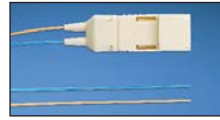

F6B6J-NM*Y

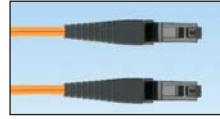

F6Z12-12M

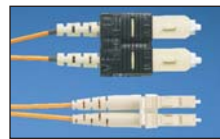

F6E3-10M*Y



F6D2-3M*Y

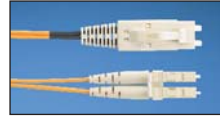

F6E6P-10M*Y

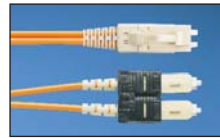

F6D6P-3M*Y



F6D6P-2M*Y

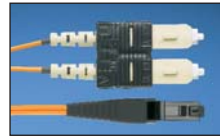

F6Z3-12M

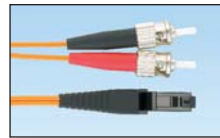

F6Z2-12M

Part Number	Part Description	Length (m)^	Std. Pkg. Qty.	Std. Ctn. Qty.
FJ® Jack Module to Pigtail – OM1 Multimode Duplex Pigtails – 900µm Buffered Fiber				
F6B6J-NM1Y	FJ® Jack Module to pigtail multimode duplex pigtail, 900µm buffered fiber (one FJ® Jack Module on one end and open on the other end) – 62.5/125µm.	1	1	10
MT-RJ to MT-RJ – OM1 Multimode Duplex Patch Cords – 1.8mm Jacketed Cable				
F6Z12-12M1	Female MT-RJ to female MT-RJ multimode duplex patch cord, 1.8mm jacketed cable (one female MT-RJ connector on each end) – 62.5/125µm.	1	1	10
SC to LC – OM1 Multimode Duplex Patch Cords – 1.6mm Jacketed Cable				
F6E3-10M1Y	SC to LC multimode duplex patch cord, 1.6mm jacketed cable (one duplex SC connector on one end and one duplex LC connector on the other end) – 62.5/125µm.	1	1	10
ST to SC – OM1 Multimode Duplex Patch Cords – 3mm Jacketed Cable				
F6D2-3M1Y	ST to SC multimode duplex patch cord, 3mm jacketed cable (two ST connectors on one end and one duplex SC connector on the other end) – 62.5/125µm.	1	1	10
FJ® Plug to LC – OM1 Multimode Duplex Patch Cords – 1.6mm Jacketed Cable				
F6E6P-10M1Y	FJ® Plug to LC multimode duplex patch cord, 1.6mm jacketed cable (one FJ® Plug on one end and one duplex LC connector on the other end) – 62.5/125µm.	1	1	10
FJ® Plug to SC – OM1 Multimode Duplex Patch Cords – 3mm Jacketed Cable				
F6D6P-3M1Y	FJ® Plug to SC multimode duplex patch cord, 3mm jacketed cable (one FJ® Plug on one end and one duplex SC connector on the other end) – 62.5/125µm.	1	1	10
FJ® Plug to ST – OM1 Multimode Duplex Patch Cords – 3mm Jacketed Cable				
F6D6P-2M1Y	FJ® Plug to ST multimode duplex patch cord, 3mm jacketed cable (one FJ® Plug on one end and two ST connectors on the other end) – 62.5/125µm.	1	1	10
SC to MT-RJ – OM1 Multimode Duplex Patch Cords – 1.8mm Jacketed Cable				
F6Z3-12M1	SC to female MT-RJ multimode duplex patch cord, 1.8mm jacketed cable (one duplex SC connector on one end and one female MT-RJ connector on the other end) – 62.5/125µm.	1	1	10
ST to MT-RJ – OM1 Multimode Duplex Patch Cords – 1.8mm Jacketed Cable				
F6Z2-12M1	ST to female MT-RJ multimode duplex patch cord, 1.8mm jacketed cable (two ST connectors on one end and one female MT-RJ connector on the other end) – 62.5/125µm.	1	1	10
FJ® Plug to MT-RJ – OM1 Multimode Duplex Patch Cords – 1.8mm Jacketed Cable				
F6Z6P-12M1	FJ® Plug to female MT-RJ multimode duplex patch cord, 1.8mm jacketed cable (one FJ® Plug on one end and one female MT-RJ connector on the other end) – 62.5/125µm.	1	1	10

‡To order standard OM2 50/125µm performance (orange cable) patch cords, replace the 6 in the part number (F6D3-3M1) with a 5 (F5D3-3M1).

^Additional lengths and availability: Patch cords are available in 1 – 10 meter lengths in 1 meter increments, and 15, 20, 25 and 30 meter lengths. Pigtails are available in 1, 2, and 3 meter lengths. To order lengths other than 1 meter, replace the 1 after the M (F6D3-3M1Y) with the desired length (F6D3-3M2Y for 2 meter length). The above lengths are stock items. For other lengths or male MT-RJs, contact Customer Service for actual lead times.

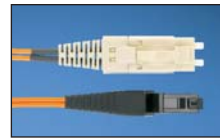

F6Z6P-12M

Cable Self-Laminating Labels for Opti-Core[®] Multimode 62.5/125µm (OM1) or 50/125µm (OM2) Fiber Optic Patch Cords and Pigtails



Suggested Label Solutions for TIA/EIA-606-A Compliance

Patch Cord Part Number	Laser/Ink Jet Desktop Printer Label	TDP43ME Thermal Transfer Desktop Printer Label	PanTher™ LS8E Hand-Held Printer Label	Cougar™ LS9 Hand-Held Printer Label
All F6S, F6E, F5S and F5E parts	S100X160YAJ and NWSLC-3Y‡	S100X150VATY and NWSLC-3Y‡	S100X160VAC and NWSLC-3Y‡	T100X000CBC-BK and NWSLC-3Y
All F6D, F6Z, F5D and F5Z parts	S100X220YAJ and NWSLC-7Y‡	S100X225VATY and NWSLC-7Y‡	S100X220VAC and NWSLC-7Y‡	T100X000CBC-BK and NWSLC-7Y

For complete labeling solutions and product information, reference charts on pages O.1 –O.18.

‡For complete information on fiber optic cable identification solutions, reference page C.92.

Opti-Core® Singlemode 9/125µm (OS1/OS2) Fiber Optic Patch Cords and Pigtails

- Available in riser (OFNR) or plenum (OFNP) flame ratings; part numbers listed are for OFNR (F9E10-10M1Y)
- For OFNP, place a P after the X in the part number and drop the Y (F9PE10-10M1)
- Pass all TIA/EIA-568-B.3 performance requirements
- LC and SC connector housing and boot colors follow TIA/EIA-568-C.3 suggested color identification scheme
- 100% factory inspected end face geometry in compliance with Telcordia GR-326-CORE, Issue 3
- Typical insertion loss per connection: 0.25dB
- UPC polished (55dB minimum return loss)
- Factory terminated and 100% tested for insertion loss and return loss
- Insertion loss and return loss data recorded for every singlemode patch cord
- Lifetime traceability of test data to a Q.C. number on each patch cord
- Highest quality flame retardant fiber optic cable with tight-buffered coating on each optical fiber



F9E10-10M*Y



F9F10-10M*Y



F9B10-NM*Y



F9D3-3M*Y



F9S3-3M*Y



F9B3-NM*Y



F9D2-2M*Y



F9S2-2M*Y



F9B2-NM*Y

Part Number	Part Description	Length (m) [^]	Std. Pkg. Qty.	Std. Ctn. Qty.
-------------	------------------	-------------------------	----------------	----------------

LC to LC – OS1/OS2 Singlemode Duplex Patch Cords – 1.6mm Jacketed Cable

F9E10-10M1Y	LC to LC singlemode duplex patch cord, 1.6mm jacketed cable (one duplex LC connector on each end) – 9/125µm.	1	1	10
--------------------	--	---	---	----

LC to LC – OS1/OS2 Singlemode Simplex Patch Cords – 1.6mm Jacketed Cable

F9F10-10M1Y	LC to LC singlemode simplex patch cord, 1.6mm jacketed cable (one LC connector on each end) – 9/125µm.	1	1	10
--------------------	--	---	---	----

LC to Pigtail – OS1/OS2 Singlemode Simplex Pigtails – 900µm Buffered Fiber

F9B10-NM1Y	LC to pigtail singlemode simplex pigtail, 900µm buffered fiber (one LC connector on one end and open on the other end) – 9/125µm.	1	1	10
-------------------	---	---	---	----

SC to SC – OS1/OS2 Singlemode Duplex Patch Cords – 3mm Jacketed Cable

F9D3-3M1Y	SC to SC singlemode duplex patch cord, 3mm jacketed cable (two SC connectors on each end) – 9/125µm.	1	1	10
------------------	--	---	---	----

SC to SC – OS1/OS2 Singlemode Simplex Patch Cords – 3mm Jacketed Cable

F9S3-3M1Y	SC to SC singlemode simplex patch cord, 3mm jacketed cable (one SC connector on each end) – 9/125µm.	1	1	10
------------------	--	---	---	----

SC to Pigtail – OS1/OS2 Singlemode Simplex Pigtails – 900µm Buffered Fiber

F9B3-NM1Y	SC to pigtail singlemode simplex pigtail, 900µm buffered fiber (one SC connector on one end and open on the other end) – 9/125µm.	1	1	10
------------------	---	---	---	----

ST to ST – OS1/OS2 Singlemode Duplex Patch Cords – 3mm Jacketed Cable

F9D2-2M1Y	ST to ST singlemode duplex patch cord, 3mm jacketed cable (two ST connectors on each end) – 9/125µm.	1	1	10
------------------	--	---	---	----

ST to ST – OS1/OS2 Singlemode Simplex Patch Cords – 3mm Jacketed Cable

F9S2-2M1Y	ST to ST singlemode simplex patch cord, 3mm jacketed cable (one ST connector on each end) – 9/125µm.	1	1	10
------------------	--	---	---	----

ST to Pigtail – OS1/OS2 Singlemode Simplex Pigtails – 900µm Buffered Fiber

F9B2-NM1Y	ST to pigtail singlemode simplex pigtail, 900µm buffered fiber (one ST connector on one end and open on the other end) – 9/125µm.	1	1	10
------------------	---	---	---	----

FJ® Plug to FJ® Plug – OS1/OS2 Singlemode Duplex Patch Cords – 3mm Jacketed Cable

F9D6P-6PM1Y	FJ® Plug to FJ® Plug singlemode duplex patch cord, 3mm jacketed cable (one FJ® Plug on each end) – 9/125µm.	1	1	10
--------------------	---	---	---	----

FJ® Jack Module to Pigtail – OS1/OS2 Singlemode Duplex Pigtails – 3mm Jacketed Cable

F9D6J-NM1Y	FJ® Jack Module to pigtail singlemode duplex pigtail, 3mm jacketed cable (one FJ® Jack Module on one end and open on the other end) – 9/125µm.	1	1	10
-------------------	--	---	---	----

[^]Additional lengths and availability: Patch cords are available in 1 – 10 meter lengths in 1 meter increments, and 15, 20, 25 and 30 meter lengths. Pigtails are available in 1, 2, and 3 meter lengths. To order lengths other than 1 meter, replace the 1 after the M (F9D3-3M1Y) with the desired length (F9D3-3M2Y for 2 meter length). The above lengths are stock items. For other lengths, contact Customer Service for actual lead time.



F9D6P-6PM*Y



F9D6J-NM*Y

Opti-Core® Singlemode 9/125µm (OS1/OS2) Fiber Optic Patch Cords and Pigtails (continued)

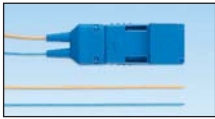

F9B6J-NM*Y



F9E3-10M*Y

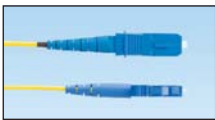

F9F3-10M*Y

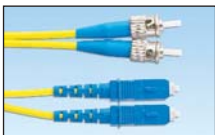

F9D2-3M*Y



F9S2-3M*Y

Part Number	Part Description	Length (m)^	Std. Pkg. Qty.	Std. Ctn. Qty.
FJ® Jack Module to Pigtail – OS1/OS2 Singlemode Duplex Pigtails – 900µm Buffered Fiber				
F9B6J-NM1Y	FJ® Jack Module to pigtail singlemode duplex pigtail, 900µm buffered fiber (one FJ® Jack Module on one end and open on the other end) – 9/125µm.	1	1	10
SC to LC – OS1/OS2 Singlemode Duplex Patch Cords – 1.6mm Jacketed Cable				
F9E3-10M1Y	SC to LC singlemode duplex patch cord, 1.6mm jacketed cable (two SC connectors on one end and one duplex LC connector on the other end) – 9/125µm.	1	1	10
SC to LC – OS1/OS2 Singlemode Simplex Patch Cords – 1.6mm Jacketed Cable				
F9F3-10M1Y	SC to LC singlemode simplex patch cord, 1.6mm jacketed cable (one SC connector on one end and one LC connector on the other end) – 9/125µm.	1	1	10
ST to SC – OS1/OS2 Singlemode Duplex Patch Cords – 3mm Jacketed Cable				
F9D2-3M1Y	ST to SC singlemode duplex patch cord, 3mm jacketed cable (two ST connectors on one end and two SC connectors on the other end) – 9/125µm.	1	1	10
ST to SC – OS1/OS2 Singlemode Simplex Patch Cord – 3mm Jacketed Cable				
F9S2-3M1Y	ST to SC singlemode simplex patch cord, 3mm jacketed cable (one ST connector on one end and one SC connector on the other end) – 9/125µm.	1	1	10
FJ® Plug to LC – OS1/OS2 Singlemode Duplex Patch Cords – 1.6mm Jacketed Cable				
F9E6P-10M1Y	FJ® Plug to LC singlemode duplex patch cord, 1.6mm jacketed cable (one FJ® Plug on one end and one duplex LC connector on the other end) – 9/125µm.	1	1	10
FJ® Plug to SC – OS1/OS2 Singlemode Duplex Patch Cords – 3mm Jacketed Cable				
F9D6P-3M1Y	FJ® Plug to SC singlemode duplex patch cord, 3mm jacketed cable (one FJ® Plug on one end and two SC connectors on the other end) – 9/125µm.	1	1	10

^Additional lengths and availability: Patch cords are available in 1 – 10 meter lengths in 1 meter increments, and 15, 20, 25 and 30 meter lengths. Pigtails are available in 1, 2, and 3 meter lengths. To order lengths other than 1 meter, replace the 1 after the M (F9D3-3M1Y) with the desired length (F9D3-3M2Y for 2 meter length). The above lengths are stock items. For other lengths, contact Customer Service for actual lead time.

Cable Self-Laminating Labels for Opti-Core® Singlemode 9/125µm (OS1/OS2) Fiber Optic Patch Cords and Pigtails



Suggested Label Solutions for TIA/EIA-606-A Compliance				
Patch Cord Part Number	Laser/Ink Jet Desktop Printer Label	TDP43ME Thermal Transfer Desktop Printer Label	PanTher™ LS8E Hand-Held Printer Label	Cougar™ LS9 Hand-Held Printer Label
All F9F parts	S100X160YAJ and NWSLC-2Y‡	S100X150VATY and NWSLC-2Y‡	S100X160VAC and NWSLC-2Y‡	T100X000CBC-BK and NWSLC-2Y
All F9S and F9E parts	S100X160YAJ and NWSLC-3Y‡	S100X150VATY and NWSLC-3Y‡	S100X160VAC and NWSLC-3Y‡	T100X000CBC-BK and NWSLC-3Y
All F9D parts	S100X220YAJ and NWSLC-7Y‡	S100X225VATY and NWSLC-7Y‡	S100X220VAC and NWSLC-7Y‡	T100X000CBC-BK and NWSLC-7Y

For complete labeling solutions and product information, reference charts on pages O.1 – O.18

‡For complete information on fiber optic cable identification solutions, reference page C.92.

NEW! Opti-Core[®] LC Patch Cords with mSFP Duplex Clip

- 5.25mm center line LC duplex clip enables mating to the mSFP form factor transceiver
- It extends the reach of Panduit's LC connector line to a new, high-density application
- Rear pivot LC latch prevents connector bundles from "fish hooking" other connectors
- Decreases amount of deflection required to mate and unmate
- Ease of installation
- Extends life of the LC connector latch and the longevity of the connector
- New strain relief boot with reduced outside diameter enables mating to the mSFP form factor transceiver
- This product is used exclusively on Brocade* FC8-64 for the DCX switch frame

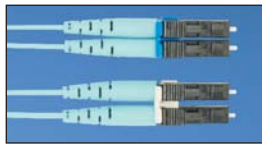

FZNLCMLE2RM00*



FZNMLMLE2RM00*



FXNLCMLE2RM00*



FXNMLMLE2RM00*

Part Number	Part Description	Length (m)	Std. Pkg. Qty.	Std. Ctn. Qty.
mSFP to LC – OM4 Multimode Patch Cords– Riser Rated (OFNR)				
FZNLCMLE2RM001	mSFP to LC, OM4, duplex, riser rated, 1.6mm jacketed cable patch cord enables mating to the mSFP form factor transceiver.	1	1	10
FZNLCMLE2RM002	mSFP to LC, OM4, duplex, riser rated, 1.6mm jacketed cable patch cord enables mating to the mSFP form factor transceiver.	2	1	10
FZNLCMLE2RM003	mSFP to LC, OM4, duplex, riser rated, 1.6mm jacketed cable patch cord enables mating to the mSFP form factor transceiver.	3	1	10
FZNLCMLE2RM005	mSFP to LC, OM4, duplex, riser rated, 1.6mm jacketed cable patch cord enables mating to the mSFP form factor transceiver.	5	1	10
FZNLCMLE2RM010	mSFP to LC, OM4, duplex, riser rated, 1.6mm jacketed cable patch cord enables mating to the mSFP form factor transceiver.	10	1	10
mSFP to mSFP – OM4 Multimode Patch Cords– Riser Rated (OFNR)				
FZNMLMLE2RM001	mSFP to mSFP, OM4, duplex, riser rated, 1.6mm jacketed cable patch cord enables mating to the mSFP form factor transceiver.	1	1	10
FZNMLMLE2RM002	mSFP to mSFP, OM4, duplex, riser rated, 1.6mm jacketed cable patch cord enables mating to the mSFP form factor transceiver.	2	1	10
mSFP to LC– OM3 Multimode Patch Cords– Riser Rated (OFNR)				
FXNLCMLE2RM001	mSFP to LC, OM3, duplex, riser rated, 1.6mm jacketed cable patch cord enables mating to the mSFP form factor transceiver.	1	1	10
FXNLCMLE2RM002	mSFP to LC, OM3, duplex, riser rated, 1.6mm jacketed cable patch cord enables mating to the mSFP form factor transceiver.	2	1	10
FXNLCMLE2RM003	mSFP to LC, OM3, duplex, riser rated, 1.6mm jacketed cable patch cord enables mating to the mSFP form factor transceiver.	3	1	10
FXNLCMLE2RM005	mSFP to LC, OM3, duplex, riser rated, 1.6mm jacketed cable patch cord enables mating to the mSFP form factor transceiver.	5	1	10
FXNLCMLE2RM010	mSFP to LC, OM3, duplex, riser rated, 1.6mm jacketed cable patch cord enables mating to the mSFP form factor transceiver.	10	1	10
mSFP to mSFP – OM3 Multimode Patch Cords– Riser Rated (OFNR)				
FXNMLMLE2RM001	mSFP to mSFP, OM3, duplex, riser rated, 1.6mm jacketed cable patch cord enables mating to the mSFP form factor transceiver.	1	1	10
FXNMLMLE2RM002	mSFP to mSFP, OM3, duplex, riser rated, 1.6mm jacketed cable patch cord enables mating to the mSFP form factor transceiver.	2	1	10

* Brocade is a trademark of Brocade Communications Systems, Inc.

* Opti-Core[®] LC Patch Cords with mSFP Duplex Clip are available in lengths of 1, 2, 3, 5, and 10 meters for LC to mSFP and 1 and 2 meters for mSFP to mSFP.

Opti-Core® APC 9/125µm (OS1/OS2) Fiber Optic Patch Cords and Pigtails

- Pass all TIA/EIA-568-B.3 performance requirements
- SC connector housing and boot colors follow TIA/EIA-568-C.3 suggested color identification scheme
- 100% factory inspected end face geometry in compliance with Telcordia GR-326-CORE, Issue 3
- Typical insertion loss per connection: 0.15dB
- APC polished (65dB minimum return loss)
- Factory terminated and 100% tested for insertion loss and return loss
- Insertion loss and return loss data recorded for every APC patch cord
- Lifetime traceability of test data to a Q.C. number on each patch cord
- Highest quality flame retardant fiber optic cable with tight-buffered coating on each optical fiber

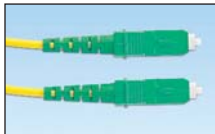

F9S3A-3AM

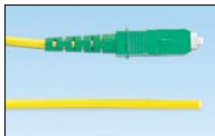

F9S3A-NM

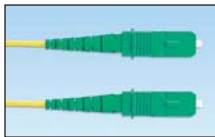

F9F3A-3AM

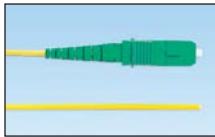

F9F3A-NM

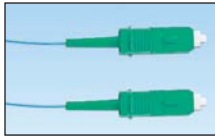

F9B3A-3AM

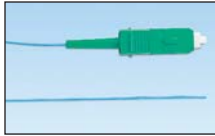

F9B3A-NM

Part Number	Part Description	Length (m)^	Std. Pkg. Qty.	Std. Ctn. Qty.
SC APC to SC APC – APC OS1/OS2 Simplex Patch Cords – 3mm Jacketed Cable				
F9S3A-3AM1	SC APC to SC APC singlemode simplex patch cord, 3mm jacketed cable (one SC APC connector on each end) – 9/125µm.	1	1	10
SC APC to Pigtail – APC OS1/OS2 Simplex Pigtails – 3mm Jacketed Cable				
F9S3A-NM1	SC APC to pigtail singlemode simplex pigtail, 3mm jacketed cable (one SC APC connector on one end and open on the other end) – 9/125µm.	1	1	10
SC APC to SC APC – APC OS1/OS2 Simplex Patch Cords – 1.6mm Jacketed Cable				
F9F3A-3AM1	SC APC to SC APC singlemode simplex patch cord, 1.6mm jacketed cable (one SC APC connector on each end) – 9/125µm.	1	1	10
SC APC to Pigtail – APC OS1/OS2 Simplex Pigtails – 1.6mm Jacketed Cable				
F9F3A-NM1	SC APC to pigtail singlemode simplex pigtail, 1.6mm jacketed cable (one SC APC connector on one end and open on the other end) – 9/125µm.	1	1	10
SC APC to SC APC – APC OS1/OS2 Simplex Patch Cords – 900µm Buffered Fiber				
F9B3A-3AM1	SC APC to SC APC singlemode simplex patch cord, 900µm buffered fiber (one SC APC connector on each end) – 9/125µm.	1	1	10
SC APC to Pigtail – APC OS1/OS2 Simplex Pigtails – 900µm Buffered Fiber				
F9B3A-NM1	SC APC to pigtail singlemode simplex pigtail, 900µm buffered fiber (one SC APC connector on one end and open on the other end) – 9/125µm.	1	1	10

^Additional lengths and availability: Patch cords are available in 1, 2, 3, 5 and 10 meter lengths. To order lengths other than 1 meter, replace the 1 at the end of the part number (F9S3A-3AM1) with the desired length (F9S3A-3AM2 for 2 meter length). The above lengths are stock items. For other lengths, contact Customer Service for actual lead times.

Cable Self-Laminating Labels for Opti-Core® APC 9/125µm (OS1/OS2) Fiber Optic Patch Cords and Pigtails

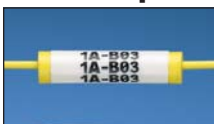

Patch Cord Part Number	Suggested Label Solutions for TIA/EIA-606-A Compliance			
	Laser/Ink Jet Desktop Printer Label	TDP43ME Thermal Transfer Desktop Printer Label	PanTher™ LS8E Hand-Held Printer Label	Cougar™ LS9 Hand-Held Printer Label
All F9F parts	S100X160YAJ and NWSLC-2Y‡	S100X150VATY and NWSLC-2Y‡	S100X160VAC and NWSLC-2Y‡	T100X000CBC-BK and NWSLC-2Y
All F9S parts	S100X160YAJ and NWSLC-3Y‡	S100X150VATY and NWSLC-3Y‡	S100X160VAC and NWSLC-3Y‡	T100X000CBC-BK and NWSLC-3Y

For complete labeling solutions and product information, reference charts on pages O.1 – O.18.
‡For complete information on fiber optic cable identification solutions, reference page C.92.



Keyed Opti-Core[®] 10Gig[™] 50/125µm (OM3) Fiber Optic Patch Cords and Pigtails

- Patch cords are tested to support network transmission speeds up to 10 Gb/s for link lengths up to 300 meters with an 850nm source per IEEE 802.3ae 10 GbE standard
- Pass all TIA/EIA-568-B.3 performance requirements
- Insertion loss per connection: 0.10dB typical; 0.30dB maximum
- Include color-specific keys with positive and negative keying features to visually and mechanically distinguish connections to prevent unauthorized mating with unlike keyed or non-keyed adapters
- Part of a complete keyed LC system that includes Opti-Core[®] Patch Cords and Pigtails, OptiCam[®] Pre-Polished Cam Connectors, Opticom[®] Fiber Adapter Panels (FAPs) and Mini-Com[®] Adapter Modules
- Backward compatible for use with all 50/125µm system requirements
- Factory terminated and 100% tested for insertion loss
- Insertion loss data recorded for every multimode patch cord
- Lifetime traceability of test data to a Q.C. number on each patch cord
- Highest quality flame retardant fiber optic cable with tight-buffered coating on each optical fiber

**FXE10B-10BM****FXB10C-NM**

Part Number	Part Description	Length (m) [^]	Std. Pkg. Qty.	Std. Ctn. Qty.
-------------	------------------	-------------------------	----------------	----------------

Keyed LC to Keyed LC – 10Gig[™] OM3 Multimode Duplex Patch Cords – 1.6mm Jacketed Cable

FXE10A-10AM1	LC (keyed A – black) to LC (keyed A – black) multimode duplex patch cord, 1.6mm jacketed cable (one duplex keyed LC connector on each end) – 10Gig [™] 50/125µm.	1	1	10
FXE10B-10BM1	LC (keyed B – red) to LC (keyed B – red) multimode duplex patch cord, 1.6mm jacketed cable (one duplex keyed LC connector on each end) – 10Gig [™] 50/125µm.	1	1	10
FXE10C-10CM1	LC (keyed C – green) to LC (keyed C – green) multimode duplex patch cord, 1.6mm jacketed cable (one duplex keyed LC connector on each end) – 10Gig [™] 50/125µm.	1	1	10
FXE10D-10DM1	LC (keyed D – yellow) to LC (keyed D – yellow) multimode duplex patch cord, 1.6mm jacketed cable (one duplex keyed D – yellow LC connector on each end) – 10Gig [™] 50/125µm.	1	1	10
FXE10E-10EM1	LC (keyed E – orange) to LC (keyed E – orange) multimode duplex patch cord, 1.6mm jacketed cable (one duplex keyed LC connector on each end) – 10Gig [™] 50/125µm.	1	1	10
FXE10F-10FM1	LC (keyed F – dark blue) to LC (keyed F – dark blue) multimode duplex patch cord, 1.6mm jacketed cable (one duplex keyed LC connector on each end) – 10Gig [™] 50/125µm.	1	1	10

Keyed LC to Pigtail – 10Gig[™] OM3 Multimode Simplex Pigtail – 900µm Buffered Fiber

FXB10A-NM1	LC (keyed A – black) to pigtail multimode simplex pigtail, 900µm buffered fiber (one keyed LC connector on one end and open on the other end) – 10Gig [™] 50/125µm.	1	1	10
FXB10B-NM1	LC (keyed B – red) to pigtail multimode simplex pigtail, 900µm buffered fiber (one keyed LC connector on one end and open on the other end) – 10Gig [™] 50/125µm.	1	1	10
FXB10C-NM1	LC (keyed C – green) to pigtail multimode simplex pigtail, 900µm buffered fiber (one keyed LC connector on one end and open on the other end) – 10Gig [™] 50/125µm.	1	1	10
FXB10D-NM1	LC (keyed D – yellow) to pigtail multimode simplex pigtail, 900µm buffered fiber (one keyed LC connector on one end and open on the other end) – 10Gig [™] 50/125µm.	1	1	10
FXB10E-NM1	LC (keyed E – orange) to pigtail multimode simplex pigtail, 900µm buffered fiber (one keyed LC connector on one end and open on the other end) – 10Gig [™] 50/125µm.	1	1	10
FXB10F-NM1	LC (keyed F – dark blue) to pigtail multimode simplex pigtail, 900µm buffered fiber (one keyed LC connector on one end and open on the other end) – 10Gig [™] 50/125µm.	1	1	10

[^]Additional lengths and availability: Keyed LC patch cords and pigtails are available in 1m – 10m lengths in 1m increments, and 15m, 20m, and 30m lengths. Keyed FJ[®] Plug Patch Cords and Pigtails are available in 1m, 2m, 3m, 5m and 10m lengths. To order lengths other than 1m, replace the 1 after the M (FXE10A-10AM1) with the desired length (FXE10A-10AM2 for 2 meter length). The above lengths are stock items. For other lengths, contact Customer Service for actual lead times.

The Keyed LC Fiber Optic System is now offering 18 colors to ensure network physical layer security with color-specific keyed connectivity. For complete keyed solutions, please reference www.panduit.com.

Keyed Opti-Core[®] 10Gig[™] 50/125µm (OM3) Fiber Optic Patch Cords and Pigtails (continued)

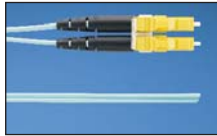

FXPE10D-NM



FXE10E-10M

Part Number	Part Description	Length (m) [^]	Std. Pkg. Qty.	Std. Ctn. Qty.
Keyed LC to Pigtail – 10Gig[™] OM3 Multimode Duplex Plenum Pigtail – 1.6mm Jacketed Cable				
FXPE10A-NM1	LC (keyed A – black) to pigtail multimode duplex plenum pigtail, 1.6mm jacketed cable (one duplex keyed LC connector on one end and open on the other end) – 10Gig [™] 50/125µm.	1	1	10
FXPE10B-NM1	LC (keyed B – red) to pigtail multimode duplex plenum pigtail, 1.6mm jacketed cable (one duplex keyed LC connector on one end and open on the other end) – 10Gig [™] 50/125µm.	1	1	10
FXPE10C-NM1	LC (keyed C – green) to pigtail multimode duplex plenum pigtail, 1.6mm jacketed cable (one duplex keyed LC connector on one end and open on the other end) – 10Gig [™] 50/125µm.	1	1	10
FXPE10D-NM1	LC (keyed D – yellow) to pigtail multimode duplex plenum pigtail, 1.6mm jacketed cable (one duplex keyed LC connector on one end and open on the other end) – 10Gig [™] 50/125µm.	1	1	10
FXPE10E-NM1	LC (keyed E – orange) to pigtail multimode duplex plenum pigtail, 1.6mm jacketed cable (one duplex keyed LC connector on one end and open on the other end) – 10Gig [™] 50/125µm.	1	1	10
FXPE10F-NM1	LC (keyed F – dark blue) to pigtail multimode duplex plenum pigtail, 1.6mm jacketed cable (one duplex keyed LC connector on one end and open on the other end) – 10Gig [™] 50/125µm.	1	1	10

Keyed LC to LC – 10Gig[™] OM3 Multimode Duplex Patch Cords – 1.6mm Jacketed Cable				
FXE10A-10M1	LC (keyed A – black) to LC multimode duplex patch cord, 1.6mm jacketed cable (one duplex keyed LC connector on one end and one duplex LC connector on the other end) – 10Gig [™] 50/125µm.	1	1	10
FXE10B-10M1	LC (keyed B – red) to LC multimode duplex patch cord, 1.6mm jacketed cable (one duplex keyed LC connector on one end and one duplex LC connector on the other end) – 10Gig [™] 50/125µm.	1	1	10
FXE10C-10M1	LC (keyed C – green) to LC multimode duplex patch cord, 10 GbE, 1.6mm jacketed cable (one duplex keyed LC connector on one end and one duplex LC connector on the other end) – 10Gig [™] 50/125µm.	1	1	10
FXE10D-10M1	LC (keyed D – yellow) to LC multimode duplex patch cord, 1.6mm jacketed cable (one duplex keyed LC connector on one end and one duplex LC connector on the other end) – 10Gig [™] 50/125µm.	1	1	10
FXE10E-10M1	LC (keyed E – orange) to LC multimode duplex patch cord, 1.6mm jacketed cable (one duplex keyed LC connector on one end and one duplex LC connector on the other end) – 10Gig [™] 50/125µm.	1	1	10
FXE10F-10M1	LC (keyed F – dark blue) to LC multimode duplex patch cord, 1.6mm jacketed cable (one duplex keyed LC connector on one end and one duplex LC connector on the other end) – 10Gig [™] 50/125µm.	1	1	10

[^]Additional lengths and availability: Keyed LC patch cords and pigtails are available in 1m – 10m lengths in 1m increments, and 15m, 20m, and 30m lengths. Keyed FJ[®] Plug Patch Cords and Pigtails are available in 1m, 2m, 3m, 5m and 10m lengths. To order lengths other than 1m, replace the 1 after the M (FXE10A-10AM1) with the desired length (FXE10A-10AM2 for 2 meter length). The above lengths are stock items. For other lengths, contact Customer Service for actual lead times.

The Keyed LC Fiber Optic System is now offering 18 colors to ensure network physical layer security with color-specific keyed connectivity. For complete keyed solutions, please reference www.panduit.com.

Table continues on page C.74

Keyed Opti-Core® 10Gig™ 50/125µm (OM3) Fiber Optic Patch Cords and Pigtails (continued)

Part Number	Part Description	Length (m) [^]	Std. Pkg. Qty.	Std. Ctn. Qty.
SC to Keyed LC – 10Gig™ OM3 Multimode Duplex Patch Cords – 1.6mm Jacketed Cable				
FXE3-10AM1	SC to LC (keyed A – black) multimode duplex patch cord, 1.6mm jacketed cable (one duplex SC connector on one end and one duplex keyed LC connector on the other end) – 10Gig™ 50/125µm.	1	1	10
FXE3-10BM1	SC to LC (keyed B – red) multimode duplex patch cord, 1.6mm jacketed cable (one duplex SC connector on one end and one duplex keyed LC connector on the other end) – 10Gig™ 50/125µm.	1	1	10
FXE3-10CM1	SC to LC (keyed C – green) multimode duplex patch cord, 1.6mm jacketed cable (one duplex SC connector on one end and one duplex keyed LC connector on the other end) – 10Gig™ 50/125µm.	1	1	10
FXE3-10DM1	SC to LC (keyed D – yellow) multimode duplex patch cord, 1.6mm jacketed cable (one duplex SC connector on one end and one duplex keyed LC connector on the other end) – 10Gig™ 50/125µm.	1	1	10
FXE3-10EM1	SC to LC (keyed E – orange) multimode duplex patch cord, 1.6mm jacketed cable (one duplex SC connector on one end and one duplex keyed LC connector on the other end) – 10Gig™ 50/125µm.	1	1	10
FXE3-10FM1	SC to LC (keyed F – dark blue) multimode duplex patch cord, 1.6mm jacketed cable (one duplex SC connector on one end and one duplex keyed LC connector on the other end) – 10Gig™ 50/125µm.	1	1	10



FXE3-10FM

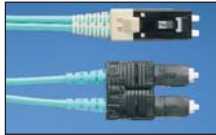

FXD6PW-3M*Y



FXD6PX-3M*Y



FXD6PY-3M*Y



FXD6PZ-3M*Y

Keyed FJ® Plug to SC – 10Gig™ OM3 Multimode Duplex Patch Cords – 3mm Jacketed Cable

FXD6PW-3M1Y	FJ® Plug (keyed W – black) to SC multimode duplex patch cord, 3mm jacketed cable (one keyed FJ® Plug on one end and one duplex SC connector on the other end) – 10Gig™ 50/125µm.	1	1	10
FXD6PX-3M1Y	FJ® Plug (keyed X – red) to SC multimode duplex patch cord, 3mm jacketed cable (one keyed FJ® Plug on one end and one duplex SC connector on the other end) – 10Gig™ 50/125µm.	1	1	10
FXD6PY-3M1Y	FJ® Plug (keyed Y – orange) to SC multimode duplex patch cord, 3mm jacketed cable (one keyed FJ® Plug on one end and one duplex SC connector on the other end) – 10Gig™ 50/125µm.	1	1	10
FXD6PZ-3M1Y	FJ® Plug (keyed Z – yellow) to SC multimode duplex patch cord, 3mm jacketed cable (one keyed FJ® Plug on one end and one duplex SC connector on the other end) – 10Gig™ 50/125µm.	1	1	10

[^]Additional lengths and availability: Keyed LC patch cords and pigtails are available in 1m – 10m lengths in 1m increments, and 15m, 20m, and 30m lengths. Keyed FJ® Plug Patch Cords and Pigtails are available in 1m, 2m, 3m, 5m and 10m lengths. To order lengths other than 1m, replace the 1 after the M (FXE10A-10AM1) with the desired length (FXE10A-10AM2 for 2 meter length). The above lengths are stock items. For other lengths, contact Customer Service for actual lead times.

The Keyed LC Fiber Optic System is now offering 18 colors to ensure network physical layer security with color-specific keyed connectivity. For complete keyed solutions, please reference www.panduit.com.

Cable Self-Laminating Labels for Keyed Opti-Core® 10Gig™ 50/125µm (OM3) Fiber Optic Patch Cords and Pigtails

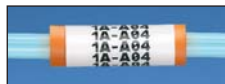

Suggested Label Solutions for TIA/EIA-606-A Compliance

Patch Cord Part Number	Laser/Ink Jet Desktop Printer Label	TDP43ME Thermal Transfer Desktop Printer Label	PanTher™ LS8E Hand-Held Printer Label	Cougar™ LS9 Hand-Held Printer Label
All FXE parts	S100X160YAJ and NWSLC-3Y‡	S100X150VATY and NWSLC-3Y‡	S100X160VAC and NWSLC-3Y‡	T100X000CBC-BK and NWSLC-3Y
All FXD parts	S100X220YAJ and NWSLC-7Y‡	S100X225VATY and NWSLC-7Y‡	S100X220VAC and NWSLC-7Y‡	T100X000CBC-BK and NWSLC-7Y

For complete labeling solutions and product information, reference charts on pages O.1 – O.18.

‡For complete information on fiber optic cable identification solutions, reference page C.92.



Keyed Opti-Core® Multimode 62.5/125µm (OM1) or 50/125µm (OM2) Fiber Optic Patch Cords and Pigtails‡

- Pass all TIA/EIA-568-B.3 performance requirements
- Insertion loss per connection: 0.10dB typical; 0.30dB maximum
- Include color-specific keys with positive and negative keying features to visually and mechanically distinguish connections to prevent unauthorized mating with unlike keyed or non-keyed adapters
- Part of a complete keyed LC system that includes Opti-Core® Patch Cords and Pigtails, OptiCam® Pre-Polished Cam Connectors, Opticom® Fiber Adapter Panels (FAPs) and Mini-Com® Adapter Modules
- Factory terminated and 100% tested for insertion loss
- Insertion loss data recorded for every multimode patch cord
- Lifetime traceability of test data to a Q.C. number on each patch cord
- Highest quality flame retardant fiber optic cable with tight-buffered coating on each optical fiber

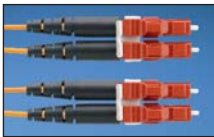

F6E10B-10BM

Part Number	Part Description	Length (m)^	Std. Pkg. Qty.	Std. Ctn. Qty.
Keyed LC to Keyed LC – OM1 Multimode Duplex Patch Cords – 1.6mm Jacketed Cable				
F6E10A-10AM1	LC (keyed A – black) to LC (keyed A – black) multimode duplex patch cord, 1.6mm jacketed cable (one duplex keyed LC connector on each end) – 62.5/125µm.	1	1	10
F6E10B-10BM1	LC (keyed B – red) to LC (keyed B – red) multimode duplex patch cord, 1.6mm jacketed cable (one duplex keyed LC connector on each end) – 62.5/125µm.	1	1	10
F6E10C-10CM1	LC (keyed C – green) to LC (keyed C – green) multimode duplex patch cord, 1.6mm jacketed cable (one duplex keyed LC connector on each end) – 62.5/125µm.	1	1	10
F6E10D-10DM1	LC (keyed D – yellow) to LC (keyed D – yellow) multimode duplex patch cord, 1.6mm jacketed cable (one duplex keyed LC connector on each end) – 62.5/125µm.	1	1	10
F6E10E-10EM1	LC (keyed E – orange) to LC (keyed E – orange) multimode duplex patch cord, 1.6mm jacketed cable (one duplex keyed LC connector on each end) – 62.5/125µm.	1	1	10
F6E10F-10FM1	LC (keyed F – dark blue) to LC (keyed F – dark blue) multimode duplex patch cord, 1.6mm jacketed cable (one duplex keyed LC connector on each end) – 62.5/125µm.	1	1	10



F6B10C-NM

Part Number	Part Description	Length (m)^	Std. Pkg. Qty.	Std. Ctn. Qty.
Keyed LC to Pigtail – OM1 Multimode Simplex Pigtail – 900µm Buffered Fiber				
F6B10A-NM1	LC (keyed A – black) to pigtail multimode simplex pigtail, 900µm buffered fiber (one keyed LC connector on one end and open on the other end) – 62.5/125µm.	1	1	10
F6B10B-NM1	LC (keyed B – red) to pigtail multimode simplex pigtail, 900µm buffered fiber (one keyed LC connector on one end and open on the other end) – 62.5/125µm.	1	1	10
F6B10C-NM1	LC (keyed C – green) to pigtail multimode simplex pigtail, 900µm buffered fiber (one keyed LC connector on one end and open on the other end) – 62.5/125µm.	1	1	10
F6B10D-NM1	LC (keyed D – yellow) to pigtail multimode simplex pigtail, 900µm buffered fiber (one keyed LC connector on one end and open on the other end) – 62.5/125µm.	1	1	10
F6B10E-NM1	LC (keyed E – orange) to pigtail multimode simplex pigtail, 900µm buffered fiber (one keyed LC connector on one end and open on the other end) – 62.5/125µm.	1	1	10
F6B10F-NM1	LC (keyed F – dark blue) to pigtail multimode simplex pigtail, 900µm buffered fiber (one keyed LC connector on one end and open on the other end) – 62.5/125µm.	1	1	10

‡To order standard OM2 50/125µm performance (orange cable) patch cords, replace the 6 in the part number (F6E10A-10AM1) with a 5 (F5E10A-10AM1).

^Additional lengths and availability: Keyed LC patch cords and pigtails are available in 1m – 10m lengths in 1m increments, and 15m, 20m, and 30m lengths. Keyed FJ® Plug Patch Cords and Pigtails are available in 1m, 2m, 3m, 5m and 10m lengths. To order lengths other than 1m, replace the 1 after the M (F6E10A-10AM1) with the desired length (F6E10A-10AM2 for 2 meter length). The above lengths are stock items. For other lengths, contact Customer Service for actual lead times.

The Keyed LC Fiber Optic System is now offering 18 colors to ensure network physical layer security with color-specific keyed connectivity. For complete keyed solutions, please reference www.panduit.com.

Table continues on page C.76

Keyed Opti-Core[®] Multimode 62.5/125 μ m (OM1) or 50/125 μ m (OM2) Fiber Optic Patch Cords and Pigtails[‡] (continued)

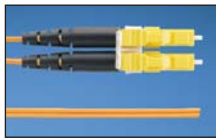

F6PE10D-NM



F6E10E-10M

Part Number	Part Description	Length (m) [^]	Std. Pkg. Qty.	Std. Ctn. Qty.
Keyed LC to Pigtail – OM1 Multimode Duplex Plenum Pigtail – 1.6mm Jacketed Cable				
F6PE10A-NM1	LC (keyed A – black) to pigtail multimode duplex plenum pigtail, 1.6mm jacketed cable (one duplex keyed LC connector on one end and open on the other end) – 62.5/125 μ m.	1	1	10
F6PE10B-NM1	LC (keyed B – red) to pigtail multimode duplex plenum pigtail, 1.6mm jacketed cable (one duplex keyed LC connector on one end and open on the other end) – 62.5/125 μ m.	1	1	10
F6PE10C-NM1	LC (keyed C – green) to pigtail multimode duplex plenum pigtail, 1.6mm jacketed cable (one duplex keyed LC connector on one end and open on the other end) – 62.5/125 μ m.	1	1	10
F6PE10D-NM1	LC (keyed D – yellow) to pigtail multimode duplex plenum pigtail, 1.6mm jacketed cable (one duplex keyed LC connector on one end and open on the other end) – 62.5/125 μ m.	1	1	10
F6PE10E-NM1	LC (keyed E – orange) to pigtail multimode duplex plenum pigtail, 1.6mm jacketed cable (one duplex keyed LC connector on one end and open on the other end) – 62.5/125 μ m.	1	1	10
F6PE10F-NM1	LC (keyed F – dark blue) to pigtail multimode duplex plenum pigtail, 1.6mm jacketed cable (one duplex keyed LC connector on one end and open on the other end) – 62.5/125 μ m.	1	1	10

Keyed LC to LC – OM1 Multimode Duplex Patch Cords – 1.6mm Jacketed Cable

F6E10A-10M1	LC (keyed A – black) to LC multimode duplex patch cord, 1.6mm jacketed cable (one duplex keyed LC connector on one end and one duplex LC connector on the other end) – 62.5/125 μ m.	1	1	10
F6E10B-10M1	LC (keyed B – red) to LC multimode duplex patch cord, 1.6mm jacketed cable (one duplex keyed LC connector on one end and one duplex LC connector on the other end) – 62.5/125 μ m.	1	1	10
F6E10C-10M1	LC (keyed C – green) to LC multimode duplex patch cord, 1.6mm jacketed cable (one duplex keyed LC connector on one end and one duplex LC connector on the other end) – 62.5/125 μ m.	1	1	10
F6E10D-10M1	LC (keyed D – yellow) to LC multimode duplex patch cord, 1.6mm jacketed cable (one duplex keyed LC connector on one end and one duplex LC connector on the other end) – 62.5/125 μ m.	1	1	10
F6E10E-10M1	LC (keyed E – orange) to LC multimode duplex patch cord, 1.6mm jacketed cable (one duplex keyed LC connector on one end and one duplex LC connector on the other end) – 62.5/125 μ m.	1	1	10
F6E10F-10M1	LC (keyed F – dark blue) to LC multimode duplex patch cord, 1.6mm jacketed cable (one duplex keyed LC connector on one end and one duplex LC connector on the other end) – 62.5/125 μ m.	1	1	10

[‡]To order standard OM2 50/125 μ m performance (orange cable) patch cords, replace the 6 in the part number (F6E10A-10AM1) with a 5 (F5E10A-10AM1).

[^]Additional lengths and availability: Keyed LC patch cords and pigtails are available in 1m – 10m lengths in 1m increments, and 15m, 20m, and 30m lengths. Keyed FJ[®] Plug Patch Cords and Pigtails are available in 1m, 2m, 3m, 5m and 10m lengths. To order lengths other than 1m, replace the 1 after the M (F6E10A-10AM1) with the desired length (F6E10A-10AM2 for 2 meter length). The above lengths are stock items. For other lengths, contact Customer Service for actual lead times.

The Keyed LC Fiber Optic System is now offering 18 colors to ensure network physical layer security with color-specific keyed connectivity. For complete keyed solutions, please reference www.panduit.com.

Keyed Opti-Core[®] Multimode 62.5/125µm (OM1) or 50/125µm (OM2) Fiber Optic Patch Cords and Pigtails‡ (continued)

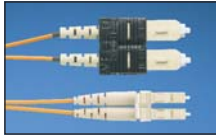

F6E3-10FM

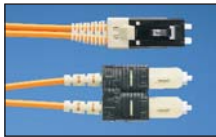

F6D6PW-3M*Y



F6D6PX-3M*Y

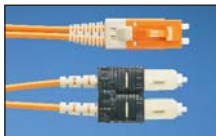

F6D6PY-3M*Y

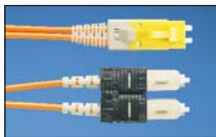

F6D6PZ-3M*Y

Part Number	Part Description	Length (m) [^]	Std. Pkg. Qty.	Std. Ctn. Qty.
SC to Keyed LC – OM1 Multimode Duplex Patch Cords – 1.6mm Jacketed Cable				
F6E3-10AM1	SC to LC (keyed A – black) multimode duplex patch cord, 1.6mm jacketed cable (one duplex SC connector on one end and one duplex keyed LC connector on the other end) – 62.5/125µm.	1	1	10
F6E3-10BM1	SC to LC (keyed B – red) multimode duplex patch cord, 1.6mm jacketed cable (one duplex SC connector on one end and one duplex keyed LC connector on the other end) – 62.5/125µm.	1	1	10
F6E3-10CM1	SC to LC (keyed C – green) multimode duplex patch cord, 1.6mm jacketed cable (one duplex SC connector on one end and one duplex keyed LC connector on the other end) – 62.5/125µm.	1	1	10
F6E3-10DM1	SC to LC (keyed D – yellow) multimode duplex patch cord, 1.6mm jacketed cable (one duplex SC connector on one end and one duplex keyed LC connector on the other end) – 62.5/125µm.	1	1	10
F6E3-10EM1	SC to LC (keyed E – orange) multimode duplex patch cord, 1.6mm jacketed cable (one duplex SC connector on one end and one duplex keyed LC connector on the other end) – 62.5/125µm.	1	1	10
F6E3-10FM1	SC to LC (keyed F – dark blue) multimode duplex patch cord, 1.6mm jacketed cable (one duplex SC connector on one end and one duplex keyed LC connector on the other end) – 62.5/125µm.	1	1	10
Keyed FJ[®] Plug to SC – OM1 Multimode Duplex Patch Cords – 3mm Jacketed Cable				
F6D6PW-3M1Y	FJ [®] Plug (keyed W – black) to SC multimode duplex patch cord, 3mm jacketed cable (one keyed FJ [®] Plug on one end and one duplex SC connector on the other end) – 62.5/125µm.	1	1	10
F6D6PX-3M1Y	FJ [®] Plug (keyed X – red) to SC multimode duplex patch cord, 3mm jacketed cable (one keyed FJ [®] Plug on one end and one duplex SC connector on the other end) – 62.5/125µm.	1	1	10
F6D6PY-3M1Y	FJ [®] Plug (keyed Y – orange) to SC multimode duplex patch cord, 3mm jacketed cable (one keyed FJ [®] Plug on one end and one duplex SC connector on the other end) – 62.5/125µm.	1	1	10
F6D6PZ-3M1Y	FJ [®] Plug (keyed Z – yellow) to SC multimode duplex patch cord, 3mm jacketed cable (one keyed FJ [®] Plug on one end and one duplex SC connector on the other end) – 62.5/125µm.	1	1	10

‡To order standard OM2 50/125µm performance (orange cable) patch cords, replace the 6 in the part number (F6E10A-10AM1) with a 5 (F5E10A-10AM1).

[^]Additional lengths and availability: Keyed LC patch cords and pigtails are available in 1m – 10m lengths in 1m increments, and 15m, 20m, and 30m lengths. Keyed FJ[®] Plug Patch Cords and Pigtails are available in 1m, 2m, 3m, 5m and 10m lengths. To order lengths other than 1m, replace the 1 after the M (F6E10A-10AM1) with the desired length (F6E10A-10AM2 for 2 meter length). The above lengths are stock items. For other lengths, contact Customer Service for actual lead times.

The Keyed LC Fiber Optic System is now offering 18 colors to ensure network physical layer security with color-specific keyed connectivity. For complete keyed solutions, please reference www.panduit.com.

Cable Self-Laminating Labels for Keyed Opti-Core[®] Multimode 62.5/125 μ m (OM1) or 50/125 μ m (OM2) Fiber Optic Patch Cords and Pigtails

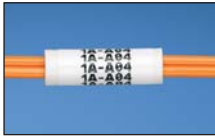

Suggested Label Solutions for TIA/EIA-606-A Compliance

Patch Cord Part Number	Laser/Ink Jet Desktop Printer Label	TDP43ME Thermal Transfer Desktop Printer Label	PanTher™ LS8E Hand-Held Printer Label	Cougar™ LS9 Hand-Held Printer Label
All F6E and F5E parts	S100X160YAJ and NWSLC-3Y ‡	S100X150VATY and NWSLC-3Y ‡	S100X160VAC and NWSLC-3Y ‡	T100X000CBC-BK and NWSLC-3Y
All F6D and F5D parts	S100X220YAJ and NWSLC-7Y ‡	S100X225VATY and NWSLC-7Y ‡	S100X220VAC and NWSLC-7Y ‡	T100X000CBC-BK and NWSLC-7Y

For complete labeling solutions and product information, reference charts on pages O.1 – O.18.

‡For complete information on fiber optic cable identification solutions, reference page C.92.



Keyed Opti-Core® Singlemode 9/125µm (OS1/OS2) Patch Cords and Pigtails

- Pass all TIA/EIA-568-B.3 performance requirements
- 100% factory inspected end face geometry in compliance with Telcordia GR-326-CORE, Issue 3
- Typical insertion loss per connection: 0.25dB
- UPC polished (55dB minimum return loss)
- Include color-specific keys with positive and negative keying features to visually and mechanically distinguish connections to prevent unauthorized mating with unlike keyed or non-keyed adapters
- Part of a complete keyed LC system that includes Opti-Core® Patch Cords and Pigtails, OptiCam® Pre-Polished Cam Connectors, Opticom® Fiber Adapter Panels (FAPs) and Mini-Com® Adapter Modules
- Factory terminated and 100% tested for insertion loss and return loss
- Insertion loss and return loss data recorded for every singlemode patch cord
- Lifetime traceability of test data to a Q.C. number on each patch cord
- Highest quality flame retardant fiber optic cable with tight-buffered coating on each optical fiber



F9E10B-10BM

Part Number	Part Description	Length (m) [^]	Std. Pkg. Qty.	Std. Ctn. Qty.
-------------	------------------	-------------------------	----------------	----------------

Keyed LC to Keyed LC – OS1/OS2 Singlemode Duplex Patch Cords – 1.6mm Jacketed Cable

F9E10A-10AM1	LC (keyed A – black) to LC (keyed A – black) singlemode duplex patch cord, 1.6mm jacketed cable (one duplex keyed LC connector on each end) – 9/125µm.	1	1	10
F9E10B-10BM1	LC (keyed B – red) to LC (keyed B – red) singlemode duplex patch cord, 1.6mm jacketed cable (one duplex keyed LC connector on each end) – 9/125µm.	1	1	10
F9E10C-10CM1	LC (keyed C – green) to LC (keyed C – green) singlemode duplex patch cord, 1.6mm jacketed cable (one duplex keyed LC connector on each end) – 9/125µm.	1	1	10
F9E10D-10DM1	LC (keyed D – yellow) to LC (keyed D – yellow) singlemode duplex patch cord, 1.6mm jacketed cable (one duplex keyed LC connector on each end) – 9/125µm.	1	1	10
F9E10E-10EM1	LC (keyed E – orange) to LC (keyed E – orange) singlemode duplex patch cord, 1.6mm jacketed cable (one duplex keyed LC connector on each end) – 9/125µm.	1	1	10
F9E10F-10FM1	LC (keyed F – dark blue) to LC (keyed F – dark blue) singlemode duplex patch cord, 1.6mm jacketed cable (one duplex keyed LC connector on each end) – 9/125µm.	1	1	10

Keyed LC to Pigtail – OS1/OS2 Singlemode Simplex Pigtail – 900µm Buffered Fiber



F9B10C-NM

F9B10A-NM1	LC (keyed A – black) to pigtail singlemode simplex pigtail, 900µm buffered fiber (one keyed LC connector on one end and open on the other end) – 9/125µm.	1	1	10
F9B10B-NM1	LC (keyed B – red) to pigtail singlemode simplex pigtail, 900µm buffered fiber (one keyed LC connector on one end and open on the other end) – 9/125µm.	1	1	10
F9B10C-NM1	LC (keyed C – green) to pigtail singlemode simplex pigtail, 900µm buffered fiber (one keyed LC connector on one end and open on the other end) – 9/125µm.	1	1	10
F9B10D-NM1	LC (keyed D – yellow) to pigtail singlemode simplex pigtail, 900µm buffered fiber (one keyed LC connector on one end and open on the other end) – 9/125µm.	1	1	10
F9B10E-NM1	LC (keyed E – orange) to pigtail singlemode simplex pigtail, 900µm buffered fiber (one keyed LC connector on one end and open on the other end) – 9/125µm.	1	1	10
F9B10F-NM1	LC (keyed F – dark blue) to pigtail singlemode simplex pigtail, 900µm buffered fiber (one keyed LC connector on one end and open on the other end) – 9/125µm.	1	1	10

Keyed LC to Pigtail – OS1/OS2 Singlemode Duplex Plenum Pigtail – 1.6mm Jacketed Cable

F9PE10A-NM1	LC (keyed A – black) to pigtail singlemode duplex plenum pigtail, 1.6mm jacketed cable (one duplex keyed LC connector on one end and open on the other end) – 9/125µm.	1	1	10
F9PE10B-NM1	LC (keyed B – red) to pigtail singlemode duplex plenum pigtail, 1.6mm jacketed cable (one duplex keyed LC connector on one end and open on the other end) – 9/125µm.	1	1	10

[^]Additional lengths and availability: Keyed LC patch cords and pigtails are available in 1m – 10m lengths in 1m increments, and 15m, 20m, and 30m lengths. Keyed FJ® Plug Patch Cords and Pigtails are available in 1m, 2m, 3m, 5m and 10m lengths. To order lengths other than 1m, replace the 1 after the M (F9E10A-10AM1) with the desired length (F9E10A-10AM2 for 2 meter length). The above lengths are stock items. For other lengths, contact Customer Service for actual lead times.

The Keyed LC Fiber Optic System is now offering 18 colors to ensure network physical layer security with color-specific keyed connectivity. For complete keyed solutions, please reference www.panduit.com.

Table continues on page C.80

Keyed Opti-Core[®] Singlemode 9/125µm (OS1/OS2) Patch Cords and Pigtails (continued)



F9PE10D-NM



F9E10E-10M

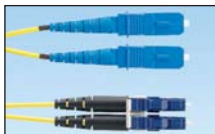

F9E3-10FM

Part Number	Part Description	Length (m) [^]	Std. Pkg. Qty.	Std. Ctn. Qty.
F9PE10C-NM1	LC (keyed C – green) to pigtail singlemode duplex plenum pigtail, 1.6mm jacketed cable (one duplex keyed LC connector on one end and open on the other end) – 9/125µm.	1	1	10
F9PE10D-NM1	LC (keyed D – yellow) to pigtail singlemode duplex plenum pigtail, 1.6mm jacketed cable (one duplex keyed LC connector on one end and open on the other end) – 9/125µm.	1	1	10
F9PE10E-NM1	LC (keyed E – orange) to pigtail singlemode duplex plenum pigtail, 1.6mm jacketed cable (one duplex keyed LC connector on one end and open on the other end) – 9/125µm.	1	1	10
F9PE10F-NM1	LC (keyed F – dark blue) to pigtail singlemode duplex plenum pigtail, 1.6mm jacketed cable (one duplex keyed LC connector on one end and open on the other end) – 9/125µm.	1	1	10

Keyed LC to LC – OS1/OS2 Singlemode Duplex Patch Cords – 1.6mm Jacketed Cable

F9E10A-10M1	LC (keyed A – black) to LC singlemode duplex patch cord, 1.6mm jacketed cable (one duplex keyed LC connector on one end and one duplex LC connector on the other end) – 9/125µm.	1	1	10
F9E10B-10M1	LC (keyed B – red) to LC singlemode duplex patch cord, 1.6mm jacketed cable (one duplex keyed LC connector on one end and one duplex LC connector on the other end) – 9/125µm.	1	1	10
F9E10C-10M1	LC (keyed C – green) to LC singlemode duplex patch cord, 1.6mm jacketed cable (one duplex keyed LC connector on one end and one duplex LC connector on the other end) – 9/125µm.	1	1	10
F9E10D-10M1	LC (keyed D – yellow) to LC singlemode duplex patch cord, 1.6mm jacketed cable (one duplex keyed LC connector on one end and one duplex LC connector on the other end) – 9/125µm.	1	1	10
F9E10E-10M1	LC (keyed E – orange) to LC singlemode duplex patch cord, 1.6mm jacketed cable (one duplex keyed LC connector on one end and one duplex LC connector on the other end) – 9/125µm.	1	1	10
F9E10F-10M1	LC (keyed F – dark blue) to LC singlemode duplex patch cord, 1.6mm jacketed cable (one duplex keyed LC connector on one end and one duplex LC connector on the other end) – 9/125µm.	1	1	10

SC to Keyed LC – OS1/OS2 Singlemode Duplex Patch Cords – 1.6mm Jacketed Cable

F9E3-10AM1	SC to LC (keyed A – black) singlemode duplex patch cord, 1.6mm jacketed cable (one duplex SC connector on one end and one duplex keyed LC connector on the other end) – 9/125µm.	1	1	10
F9E3-10BM1	SC to LC (keyed B – red) singlemode duplex patch cord, 1.6mm jacketed cable (one duplex SC connector on one end and one duplex keyed LC connector on the other end) – 9/125µm.	1	1	10
F9E3-10CM1	SC to LC (keyed C – green) singlemode duplex patch cord, 1.6mm jacketed cable (one duplex SC connector on one end and one duplex keyed C LC connector on the other end) – 9/125µm.	1	1	10
F9E3-10DM1	SC to LC (keyed D – yellow) singlemode duplex patch cord, 1.6mm jacketed cable (one duplex SC connector on one end and one duplex keyed LC connector on the other end) – 9/125µm.	1	1	10
F9E3-10EM1	SC to LC (keyed E – orange) singlemode duplex patch cord, 1.6mm jacketed cable (one duplex SC connector on one end and one duplex keyed LC connector on the other end) – 9/125µm.	1	1	10
F9E3-10FM1	SC to LC (keyed F – dark blue) singlemode duplex patch cord, 1.6mm jacketed cable (one duplex SC connector on one end and one duplex keyed LC connector on the other end) – 9/125µm.	1	1	10

[^]Additional lengths and availability: Keyed LC patch cords and pigtails are available in 1m – 10m lengths in 1m increments, and 15m, 20m, and 30m lengths. Keyed FJ[®] Plug Patch Cords and Pigtails are available in 1m, 2m, 3m, 5m and 10m lengths. To order lengths other than 1m, replace the 1 after the M (F9E10A-10AM1) with the desired length (F9E10A-10AM2 for 2 meter length). The above lengths are stock items. For other lengths, contact Customer Service for actual lead times.

The Keyed LC Fiber Optic System is now offering 18 colors to ensure network physical layer security with color-specific keyed connectivity. For complete keyed solutions, please reference www.panduit.com.

Cable Self-Laminating Labels for Keyed Opti-Core[®] Singlemode 9/125µm (OS1/OS2) Patch Cords and Pigtails



Suggested Label Solutions for TIA/EIA-606-A Compliance

Patch Cord Part Number	Laser/Ink Jet Desktop Printer Label	TDP43ME Thermal Transfer Desktop Printer Label	PanTher™ LS8E Hand-Held Printer Label	Cougar™ LS9 Hand-Held Printer Label
All F9E parts	S100X160YAJ and NWSLC-3Y‡	S100X150VATY and NWSLC-3Y‡	S100X160VAC and NWSLC-3Y‡	T100X000CBC-BK and NWSLC-3Y

For complete labeling solutions and product information, reference charts on pages O.1 – O.18

‡For complete information on fiber optic cable identification solutions, reference page C.92.



LC Lock-In Duplex Clip

- Used with Opti-Core[®] LC and Keyed LC Patch Cords to prevent unauthorized removal of cable or other networking equipment or critical connection
- Secures connections to reduce network downtime, data security breaches, and hardware replacement due to theft

- Installation/removal tool allows connectors to be locked into or released from adapters in modules, FAPs, cassettes, or patch panels for enhanced physical security
- Limits access of an LC or Keyed LC System that includes Opti-Core[®] Patch Cords and Pigtails, Opticom[®] Fiber Adapter Panels (FAPs), and Mini-Com[®] Adapter Modules



Part Number	Part Description	Color	Std. Pkg. Qty.	Std. Ctn. Qty.
FLCCLIW-X	Package of ten LC duplex lock-in clips and one removal tool.	Off White	10	100



LC Duplex Adapter Blockout Device

- TIA/EIA-604 FOCIS-10 compliant device fits all LC duplex adapters for a variety of applications and installations
- Tamper-resistant design blocks unauthorized access to LC duplex ports to reduce the risk of damage, saving time and money associated with downtime, repairs, and hardware replacement
- Compact, low profile design allows installation or removal without disturbing adjacent ports or installed patch cords in high-density applications

- Also functions as dust plug to mechanically protect the LC adapter optics and render it “eye-safe”
- Removal tool allows only authorized personnel to release the device, ensuring safety and security of your network infrastructure
- Available in multiple colors to match or contrast adapter colors for easy identification of blocked out adapters



Part Number	Part Description	Color	Std. Pkg. Qty.	Std. Ctn. Qty.
PSL-LCAB*	Package of ten LC duplex adapter blockout devices and one removal tool.	Red	1	20

*For other colors, add -AQ for Aqua, -BL for Black, -BU for Blue, or -EI for Electric Ivory. Also available in bulk packages of 100 devices and five removal tools. To order bulk package, add -C to the end of the part number.



SC Adapter Blockout Device

- TIA/EIA-604 FOCIS-3 compliant device fits all SC adapters for a variety of applications and installations
- Tamper-resistant design blocks unauthorized access to SC switch and HBA/NIC ports, switch uplinks and user outlets, saving time and money associated with data security breaches, network downtime, repairs, and hardware replacement
- Compact, low profile design allows installation or removal without disturbing adjacent ports or installed patch cords in high-density applications

- Also functions as dust plug to mechanically protect the SC adapters/receptacle optics and renders it “eye-safe” to prevent exposure to laser radiation and contamination on dust sensitive transceivers
- Removal tool allows only authorized personnel to release the device, ensuring safety and security of your network infrastructure
- Available in multiple colors for visual identification or aesthetics



Part Number	Part Description	Color	Std. Pkg. Qty.	Std. Ctn. Qty.
PSL-SCBD*	Package of ten SC adapter blockout devices and one removal tool.	Red	1	20

*For other colors, add -AQ for Aqua, -BL for Black, -BU for Blue, -EI for Electric Ivory, or -AG for Green to the end of the part number. Also available in bulk packages of 100 devices and five removal tools. To order bulk package, add -C to the end of the part number.

Opti-Core® Fiber Optic Reference Cable Assembly Kits

- Reference and master grade cable assemblies pass all TIA/EIA-568-B.3 performance requirements
- 100% factory-inspected endface geometry in compliance with Telcordia GR-326-CORE, Issue 3
- Insertion loss per connection: 0.10dB maximum (multimode and singlemode)
- Return loss: 40dB minimum, PC polished (multimode); 58dB minimum, UPC polished (singlemode)
- Include 2-meter cable assemblies: standard grade to reference grade reference cable assemblies, and standard grade to reference grade master cable assemblies, zirconia ceramic adapters, and a set of mandrels (multimode kits)
- Master cable assemblies provide in-field qualification of reference cable assemblies for test use
- Available in multimode (10Gig™ OM3 and OM1) and singlemode (OS1/OS2) fiber types for link testing and diagnostic troubleshooting flexibility
- 10Gig™ 50/125µm (gray) or 62.5/125µm (black) mandrels are provided to allow mode conditioning and stripping for testing fiber to applicable standards requirements
- Factory terminated and 100% tested for insertion loss and return loss; data supplied with each reference and master cable assembly
- Provide superior measurement capability to maximize link reliability
- Controlled ferrule endface geometry is documented and supplied, assuring repeatable high performance physical contact of fiber connectors under test
- Hybrid reference cords available for use in testing permanent links with connectors that differ from test set connectors
- Reference quality connectors on both ends of cable assemblies allow both ends to be used to mate to the permanent link for loss measurements



Part Number	Part Description	Std. Pkg. Qty.
10Gig™ OM3 Multimode Reference Cable Assembly Kits		
FR1XS1-R1KIT	Simplex LC-LC/SC-LC 10Gig™ 50/125µm multimode reference cable assembly kit, includes: 2 simplex std. grade LC to ref. grade LC reference cables (2m) 2 simplex std. grade SC to ref. grade LC reference cables (2m) 2 simplex std. grade LC to ref. grade LC master cables (2m) 2 LC duplex adapters (zirconia ceramic split sleeves) 2 mandrels (50/125µm)	1
FR2XSS-RSKIT	Duplex SC-SC 10Gig™ 50/125µm multimode reference cable assembly kit, includes: 2 duplex std. grade SC to ref. grade SC reference cables (2m) 1 duplex std. grade SC to ref. grade SC master cable (2m) 2 SC duplex adapters (zirconia ceramic split sleeves) 2 mandrels (50/125µm)	1
FR2XS2-RSKIT	Duplex ST-SC 10Gig™ 50/125µm multimode reference cable assembly kit, includes: 2 duplex std. grade ST to ref. grade SC reference cables (2m) 1 duplex std. grade ST to ref. grade SC master cable (2m) 2 SC duplex adapters (zirconia ceramic split sleeves) 2 mandrels (50/125µm)	1
FR2XSS-RLKIT	Duplex SC-LC 10Gig™ 50/125µm multimode reference cable assembly kit, includes: 2 duplex std. grade SC to ref. grade LC reference cables (2m) 1 duplex std. grade SC to ref. grade LC master cable (2m) 2 LC duplex adapters (zirconia ceramic split sleeves) 2 mandrels (50/125µm)	1
FR1XS2-R2KIT	Simplex SC-ST/ST-ST 10Gig™ 50/125µm multimode reference cable assembly kit, includes: 2 simplex std. grade SC to ref. grade ST reference cables (2m) 2 simplex std. grade ST to ref. grade ST reference cables (2m) 2 simplex std. grade ST to ref. grade ST master cables (2m) 4 ST simplex adapters (zirconia ceramic split sleeves) 2 mandrels (50/125µm)	1
FR2XS2-R2KIT	Duplex ST-ST 10Gig™ 50/125µm multimode reference cable assembly kit, includes: 2 duplex std. grade ST to ref. grade ST reference cables (2m) 2 duplex std. grade ST to ref. grade ST master cables (2m) 4 ST simplex adapters (zirconia ceramic split sleeves) 2 mandrels (50/125µm)	1

Table continues on page C.84

Opti-Core[®] Fiber Optic Reference Cable Assembly Kits (continued)

Part Number	Part Description	Std. Pkg. Qty.
FR2XS2-RLKIT	Duplex ST-LC 10Gig™ 50/125µm multimode reference cable assembly kit, includes: 2 duplex std. grade ST to ref. grade LC reference cables (2m) 2 duplex std. grade ST to ref. grade LC master cables (2m) 2 LC duplex adapters (zirconia ceramic split sleeves) 2 mandrels (50/125µm)	1
FR2XSS-R2KIT	Duplex SC-ST 10Gig™ 50/125µm multimode reference cable assembly kit, includes: 2 duplex std. grade SC to ref. grade ST reference cables (2m) 2 duplex std. grade SC to ref. grade ST master cables (2m) 4 ST simplex adapters (zirconia ceramic split sleeves) 2 mandrels (50/125µm)	1

OM1 Multimode Reference Cable Assembly Kits

FR16S1-R1KIT	Simplex LC-LC/SC-LC 62.5/125µm multimode reference cable assembly kit, includes: 2 simplex std. grade LC to ref. grade LC reference cables (2m) 2 simplex std. grade SC to ref. grade LC reference cables (2m) 2 simplex std. grade LC to ref. grade LC master cables (2m) 2 LC duplex adapters (zirconia ceramic split sleeves) 2 mandrels (62.5/125µm)	1
FR26SS-RSKIT	Duplex SC-SC 62.5/125µm multimode reference cable assembly kit, includes: 2 duplex std. grade SC to ref. grade SC reference cables (2m) 1 duplex std. grade SC to ref. grade SC master cable (2m) 2 SC duplex adapters (zirconia ceramic split sleeves) 2 mandrels (62.5/125µm)	1
FR26S2-RSKIT	Duplex ST-SC 62.5/125µm multimode reference cable assembly kit, includes: 2 duplex std. grade ST to ref. grade SC reference cables (2m) 1 duplex std. grade ST to ref. grade SC master cable (2m) 2 SC duplex adapters (zirconia ceramic split sleeves) 2 mandrels (62.5/125µm)	1
FR26SS-RLKIT	Duplex SC-LC 62.5/125µm multimode reference cable assembly kit, includes: 2 duplex std. grade SC to ref. grade LC reference cables (2m) 1 duplex std. grade SC to ref. grade LC master cable (2m) 2 LC duplex adapters (zirconia ceramic split sleeves) 2 mandrels (62.5/125µm)	1
FR16S2-R2KIT	Simplex SC-ST/ST-ST 62.5/125µm multimode reference cable assembly kit, includes: 2 simplex std. grade SC to ref. grade ST reference cables (2m) 2 simplex std. grade ST to ref. grade ST reference cables (2m) 2 simplex std. grade ST to ref. grade ST master cables (2m) 4 ST simplex adapters (zirconia ceramic split sleeves) 2 mandrels (62.5/125µm)	1
FR26S2-R2KIT	Duplex ST-ST 62.5/125µm multimode reference cable assembly kit, includes: 2 duplex std. grade ST to ref. grade ST reference cables (2m) 2 duplex std. grade ST to ref. grade ST master cables (2m) 4 ST simplex adapters (zirconia ceramic split sleeves) 2 mandrels (62.5/125µm)	1
FR26S2-RLKIT	Duplex ST-LC 62.5/125µm multimode reference cable assembly kit, includes: 2 duplex std. grade ST to ref. grade LC reference cables (2m) 2 duplex std. grade ST to ref. grade LC master cables (2m) 2 LC duplex adapters (zirconia ceramic split sleeves) 2 mandrels (62.5/125µm)	1
FR26SS-R2KIT	Duplex SC-ST 62.5/125µm multimode reference cable assembly kit, includes: 2 duplex std. grade SC to ref. grade ST reference cables (2m) 2 duplex std. grade SC to ref. grade ST master cables (2m) 4 ST simplex adapters (zirconia ceramic split sleeves) 2 mandrels (62.5/125µm)	1

Opti-Core® Fiber Optic Reference Cable Assembly Kits (continued)

Part Number	Part Description	Std. Pkg. Qty.
OS1/OS2 Singlemode Reference Cable Assembly Kits		
FR19S1-R1KIT	Simplex LC-LC/SC-LC 9µm singlemode reference cable assembly kit, includes: 2 simplex std. grade LC to ref. grade LC reference cables (2) 2 simplex std. grade SC to ref. grade LC reference cables (2) 2 simplex std. grade LC to ref. grade LC master cables (2) 2 LC duplex adapters (zirconia ceramic split sleeves)	1
FR29SS-RSKIT	Duplex SC-SC 9µm singlemode reference cable assembly kit, includes: 2 duplex std. grade SC to ref. grade SC reference cables (2m) 1 duplex std. grade SC to ref. grade SC master cable (2m) 2 SC duplex adapters (zirconia ceramic split sleeves)	1
FR29S2-RSKIT	Duplex ST-SC 9µm singlemode reference cable assembly kit, includes: 2 duplex std. grade ST to ref. grade SC reference cables (2m) 1 duplex std. grade ST to ref. grade SC master cable (2m) 2 SC duplex adapters (zirconia ceramic split sleeves)	1
FR29SS-RLKIT	Duplex SC-LC 9µm singlemode reference cable assembly kit, includes: 2 duplex std. grade SC to ref. grade LC reference cables (2m) 1 duplex std. grade SC to ref. grade LC master cable (2m) 2 LC duplex adapters (zirconia ceramic split sleeves)	1
FR19S2-R2KIT	Simplex SC-ST/ST-ST 9µm singlemode reference cable assembly kit, includes: 2 simplex std. grade SC to ref. grade ST reference cables (2m) 2 simplex std. grade ST to ref. grade ST reference cables (2m) 2 simplex std. grade ST to ref. grade ST master cables (2m) 4 ST simplex adapters (zirconia ceramic split sleeves)	1
FR29S2-R2KIT	Duplex ST-ST 9µm singlemode reference cable assembly kit, includes: 2 duplex std. grade ST to ref. grade ST reference cables (2m) 2 duplex std. grade ST to ref. grade ST master cables (2m) 4 ST simplex adapters (zirconia ceramic split sleeves)	1
FR29S2-RLKIT	Duplex ST-LC 9µm singlemode reference cable assembly kit, includes: 2 duplex std. grade ST to ref. grade LC reference cables (2m) 2 duplex std. grade ST to ref. grade LC master cables (2m) 2 LC duplex adapters (zirconia ceramic split sleeves)	1
FR29SS-R2KIT	Duplex SC-ST 9µm singlemode reference cable assembly kit, includes: 2 duplex std. grade SC to ref. grade ST reference cables (2m) 2 duplex std. grade SC to ref. grade ST master cables (2m) 4 ST simplex adapters (zirconia ceramic split sleeves)	1

Opti-Core[®] Fiber Optic Reference Cable Assemblies

- Pass all TIA/EIA-568-B.3 performance requirements
- 100% factory inspected endface geometry in compliance with Telcordia GR-326-CORE, Issue 3
- Insertion loss per connection: 0.10dB maximum (multimode and singlemode)
- Return loss: 40dB minimum, PC polished (multimode); 58dB minimum, UPC polished (singlemode)
- Standard grade to reference grade riser (OFNR) rated cable assemblies are available in 2 meter lengths in multimode (10Gig[™] OM3 50µm and OM1 62.5µm) and singlemode (OS1/OS2 9µm) fiber types for link testing and diagnostic troubleshooting flexibility
- Factory terminated and 100% tested for insertion loss and return loss; data recorded and supplied with each reference cable assembly
- Provide superior measurement capability to maximize link reliability
- Controlled ferrule endface geometry is documented and supplied, assuring repeatable high performance physical contact of fiber connectors under test
- Hybrid reference cords are available for use in testing permanent links with connectors that differ from test set connectors
- Reference quality connectors on both ends of cable assembly allow both ends to be used to mate to the permanent link for loss measurements
- Opti-Core[®] Fiber Optic Reference Cable Assembly Kits are also available for in-field qualification of reference cord for test use

**FR2XSS-R2M02**

Part Number	Part Description	Length (m)	Std. Pkg. Qty.	Std. Ctn. Qty.
10Gig[™] OM3 Multimode Duplex Reference Cable Assemblies				
FR2XSL-RLM02	Duplex standard grade LC to reference grade LC reference cable assembly, riser rated 2mm jacketed cable – 10Gig [™] 50/125µm.	2	1	10
FR2XSL-RSM02	Duplex standard grade LC to reference grade SC reference cable assembly, riser rated 2mm jacketed cable – 10Gig [™] 50/125µm.	2	1	10
FR2XSL-R2M02	Duplex standard grade LC to reference grade ST reference cable assembly, riser rated 2mm jacketed cable – 10Gig [™] 50/125µm.	2	1	10
FR2XSS-RSM02	Duplex standard grade SC to reference grade SC reference cable assembly, riser rated 2mm jacketed cable – 10Gig [™] 50/125µm.	2	1	10
FR2XSS-RLM02	Duplex standard grade SC to reference grade LC reference cable assembly, riser rated 2mm jacketed cable – 10Gig [™] 50/125µm.	2	1	10
FR2XSS-R2M02	Duplex standard grade SC to reference grade ST reference cable assembly, riser rated 2mm jacketed cable – 10Gig [™] 50/125µm.	2	1	10
FR2XS2-R2M02	Duplex standard grade ST to reference grade ST reference cable assembly, riser rated 2mm jacketed cable – 10Gig [™] 50/125µm.	2	1	10
FR2XS2-RLM02	Duplex standard grade ST to reference grade LC reference cable assembly, riser rated 2mm jacketed cable – 10Gig [™] 50/125µm.	2	1	10
FR2XS2-RSM02	Duplex standard grade ST to reference grade SC reference cable assembly, riser rated 2mm jacketed cable – 10Gig [™] 50/125µm.	2	1	10

Opti-Core[®] Fiber Optic Reference Cable Assemblies (continued)

Part Number	Part Description	Length (m)	Std. Pkg. Qty.	Std. Ctn. Qty.
10Gig™ OM3 Multimode Simplex Reference Cable Assemblies				
FR1XS1-R1M02	Simplex standard grade LC to reference grade LC reference cable assembly, riser rated 2mm jacketed cable – 10Gig™ 50/125µm.	2	1	10
FR1XS1-R3M02	Simplex standard grade LC to reference grade SC reference cable assembly, riser rated 2mm jacketed cable – 10Gig™ 50/125µm.	2	1	10
FR1XS1-R2M02	Simplex standard grade LC to reference grade ST reference cable assembly, riser rated 2mm jacketed cable – 10Gig™ 50/125µm.	2	1	10
FR1XS3-R3M02	Simplex standard grade SC to reference grade SC reference cable assembly, riser rated 2mm jacketed cable – 10Gig™ 50/125µm.	2	1	10
FR1XS3-R1M02	Simplex standard grade SC to reference grade LC reference cable assembly, riser rated 2mm jacketed cable – 10Gig™ 50/125µm.	2	1	10
FR1XS3-R2M02	Simplex standard grade SC to reference grade ST reference cable assembly, riser rated 2mm jacketed cable – 10Gig™ 50/125µm.	2	1	10
FR1XS2-R2M02	Simplex standard grade ST to reference grade ST reference cable assembly, riser rated 2mm jacketed cable – 10Gig™ 50/125µm.	2	1	10
FR1XS2-R1M02	Simplex standard grade ST to reference grade LC reference cable assembly, riser rated 2mm jacketed cable – 10Gig™ 50/125µm.	2	1	10
FR1XS2-R3M02	Simplex standard grade ST to reference grade SC reference cable assembly, riser rated 2mm jacketed cable – 10Gig™ 50/125µm.	2	1	10
OM1 Multimode Duplex Reference Cable Assemblies				
FR26SL-RLM02	Duplex standard grade LC to reference grade LC multimode reference cable assembly, riser rated 2mm jacketed cable – 62.5/125µm.	2	1	10
FR26SL-RSM02	Duplex standard grade LC to reference grade SC multimode reference cable assembly, riser rated 2mm jacketed cable – 62.5/125µm.	2	1	10
FR26SL-R2M02	Duplex standard grade LC to reference grade ST multimode reference cable assembly, riser rated 2mm jacketed cable – 62.5/125µm.	2	1	10
FR26SS-RSM02	Duplex standard grade SC to reference grade SC multimode reference cable assembly, riser rated 2mm jacketed cable – 62.5/125µm.	2	1	10
FR26SS-RLM02	Duplex standard grade SC to reference grade LC multimode reference cable assembly, riser rated 2mm jacketed cable – 62.5/125µm.	2	1	10
FR26SS-R2M02	Duplex standard grade SC to reference grade ST multimode reference cable assembly, riser rated 2mm jacketed cable – 62.5/125µm.	2	1	10
FR26S2-R2M02	Duplex standard grade ST to reference grade ST multimode reference cable assembly, riser rated 2mm jacketed cable – 62.5/125µm.	2	1	10
FR26S2-RLM02	Duplex standard grade ST to reference grade LC multimode reference cable assembly, riser rated 2mm jacketed cable – 62.5/125µm.	2	1	10
FR26S2-RSM02	Duplex standard grade ST to reference grade SC multimode reference cable assembly, riser rated 2mm jacketed cable – 62.5/125µm.	2	1	10

Table continues on page C.88

Opti-Core[®] Fiber Optic Reference Cable Assemblies (continued)

Part Number	Part Description	Length (m)	Std. Pkg. Qty.	Std. Ctn. Qty.
OM1 Multimode Simplex Reference Cable Assemblies				
FR16S1-R1M02	Simplex standard grade LC to reference grade LC multimode reference cable assembly, riser rated 2mm jacketed cable – 62.5/125µm.	2	1	10
FR16S1-R3M02	Simplex standard grade LC to reference grade SC multimode reference cable assembly, riser rated 2mm jacketed cable – 62.5/125µm.	2	1	10
FR16S1-R2M02	Simplex standard grade LC to reference grade ST multimode reference cable assembly, riser rated 2mm jacketed cable – 62.5/125µm.	2	1	10
FR16S3-R3M02	Simplex standard grade SC to reference grade SC multimode reference cable assembly, riser rated 2mm jacketed cable – 62.5/125µm.	2	1	10
FR16S3-R1M02	Simplex standard grade SC to reference grade LC multimode reference cable assembly, riser rated 2mm jacketed cable – 62.5/125µm.	2	1	10
FR16S3-R2M02	Simplex standard grade SC to reference grade ST multimode reference cable assembly, riser rated 2mm jacketed cable – 62.5/125µm.	2	1	10
FR16S2-R2M02	Simplex standard grade ST to reference grade ST multimode reference cable assembly, riser rated 2mm jacketed cable – 62.5/125µm.	2	1	10
FR16S2-R1M02	Simplex standard grade ST to reference grade LC multimode reference cable assembly, riser rated 2mm jacketed cable – 62.5/125µm.	2	1	10
FR16S2-R3M02	Simplex standard grade ST to reference grade SC multimode reference cable assembly, riser rated 2mm jacketed cable – 62.5/125µm.	2	1	10
OS1/OS2 Singlemode Duplex Reference Cable Assemblies				
FR29SL-RLM02	Duplex standard grade LC to reference grade LC singlemode reference cable assembly, riser rated 2mm jacketed cable – 9/125µm.	2	1	10
FR29SL-RSM02	Duplex standard grade LC to reference grade SC singlemode reference cable assembly, riser rated 2mm jacketed cable – 9/125µm.	2	1	10
FR29SL-R2M02	Duplex standard grade LC to reference grade ST singlemode reference cable assembly, riser rated 2mm jacketed cable – 9/125µm.	2	1	10
FR29SS-RSM02	Duplex standard grade SC to reference grade SC singlemode reference cable assembly, riser rated 2mm jacketed cable – 9/125µm.	2	1	10
FR29SS-RLM02	Duplex standard grade SC to reference grade LC singlemode reference cable assembly, riser rated 2mm jacketed cable – 9/125µm.	2	1	10
FR29SS-R2M02	Duplex standard grade SC to reference grade ST singlemode reference cable assembly, riser rated 2mm jacketed cable – 9/125µm.	2	1	10
FR29S2-R2M02	Duplex standard grade ST to reference grade ST singlemode reference cable assembly, riser rated 2mm jacketed cable – 9/125µm.	2	1	10
FR29S2-RLM02	Duplex standard grade ST to reference grade LC singlemode reference cable assembly, riser rated 2mm jacketed cable – 9/125µm.	2	1	10
FR29S2-RSM02	Duplex standard grade ST to reference grade SC singlemode reference cable assembly, riser rated 2mm jacketed cable – 9/125µm.	2	1	10

Opti-Core[®] Fiber Optic Reference Cable Assemblies (continued)

Part Number	Part Description	Length (m)	Std. Pkg. Qty.	Std. Ctn. Qty.
OS1/OS2 Singlemode Simplex Reference Cable Assemblies				
FR19S1-R1M02	Simplex standard grade LC to reference grade LC singlemode reference cable assembly, riser rated 2mm jacketed cable – 9/125µm.	2	1	10
FR19S1-R3M02	Simplex standard grade LC to reference grade SC singlemode reference cable assembly, riser rated 2mm jacketed cable – 9/125µm.	2	1	10
FR19S1-R2M02	Simplex standard grade LC to reference grade ST singlemode reference cable assembly, riser rated 2mm jacketed cable – 9/125µm.	2	1	10
FR19S3-R3M02	Simplex standard grade SC to reference grade SC singlemode reference cable assembly, riser rated 2mm jacketed cable – 9/125µm.	2	1	10
FR19S3-R1M02	Simplex standard grade SC to reference grade LC singlemode reference cable assembly, riser rated 2mm jacketed cable – 9/125µm.	2	1	10
FR19S3-R2M02	Simplex standard grade SC to reference grade ST singlemode reference cable assembly, riser rated 2mm jacketed cable – 9/125µm.	2	1	10
FR19S2-R2M02	Simplex standard grade ST to reference grade ST singlemode reference cable assembly, riser rated 2mm jacketed cable – 9/125µm.	2	1	10
FR19S2-R1M02	Simplex standard grade ST to reference grade LC singlemode reference cable assembly, riser rated 2mm jacketed cable – 9/125µm.	2	1	10
FR19S2-R3M02	Simplex standard grade ST to reference grade SC singlemode reference cable assembly, riser rated 2mm jacketed cable – 9/125µm.	2	1	10

LabelCore™ Fiber Optic Cable Identification System

- Provides a larger labeling surface on small cables allowing legends to be clearly seen
- Sleeve is made of flexible PVC material
- Locate sleeve on straight section of cable at least 2.00" from fiber boot

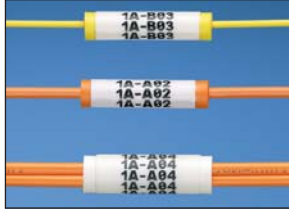

Part Number	Part Description	Std. Pkg. Qty.*	Std. Ctn. Qty.
NWSLC-2Y	Yellow, cable identification sleeve for 2mm simplex fiber cable.	100	1000
NWSLC-3Y	Orange, cable identification sleeve for 3mm simplex fiber cable.	100	1000
NWSLC-7Y	White, cable identification sleeve for 3mm duplex fiber cable.	100	1000

*Order number of sleeves required.

Self-Laminating Labels for Laser/Ink Jet Desktop Printers Supplied on 8.50" x 11.00" Sheets

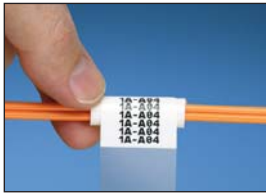

Apply LabelCore™ Sleeve to cable



Wrap self-laminating label around LabelCore™ Sleeve

Self-Laminating Labels for LabelCore™ Fiber Optic Cable Identification System

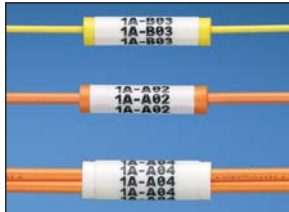

Suggested Label Solutions for TIA/EIA-606-A Compliance

LabelCore™ Sleeve Part Number	Laser/Ink Jet Desktop Printer Label	TDP43ME Thermal Transfer Desktop Printer Label	PanTher™ LS8E Hand-Held Printer Label	Cougar™ LS9 Hand-Held Printer Label
NWSLC-2Y	S100X160YAJ	S100X150VATY	S100X160VAC	T100X000CBC-BK
NWSLC-3Y	S100X220YAJ	S100X225VATY	S100X220VAC	T100X000CBC-BK
NWSLC-7Y	S100X220YAJ	S100X225VATY	S100X220VAC	T100X000CBC-BK

For complete labeling solutions and product information, reference charts on pages O.1 – O.18.

QuickNet™ Hydra Cable Assemblies

- Connectivity meets or exceeds TIA/EIA-568-B.3 and ISO/IEC 11801 performance requirements
- LC and SC connector housing and boot colors follow TIA/EIA-568-C.3 suggested color identification scheme
- Jacketed cable is compliant with NFPA 262 (OFNP) flame rating
- MTP* (12-fiber) connectors are FOCIS-5 compliant
- Insertion loss per mated pair: 0.50dB typical, 0.75dB max.
- Panduit proprietary MTP* polishing provides low insertion loss and high return loss, minimizing variability for improved channel link loss performance
- Traditional connectors (Panduit LC, SC, and ST) provide design flexibility throughout the data center
- Insertion loss per mated pair: 0.10dB typical, 0.30dB max. (multimode); 0.25dB typical, 0.50dB max. (singlemode)
- Factory terminated and 100% tested for insertion loss (test data supplied with each assembly); singlemode and 10Gig™ Multimode Hydra Cable Assemblies also tested for return loss
- TIA/EIA-568-B.1-7 standards based polarity supports 10 Gb/s, multimode, and singlemode fiber types, and allows infrastructure backwards compatibility for component interchangeability and a lower cost of ownership
- 10Gig™ laser optimized fiber is tested per IEEE 802.3ae 10 GbE to support network transmission speeds up to 10 Gb/s for link lengths up to 300 meters at 850nm
- Application specific designs available to tailor configuration, reach, and breakout construction to application requirements; for more information contact Panduit or visit www.panduit.com



FHPX126LM***N

Part Number	Part Description	Length (m)^	Std. Pkg. Qty.
Male MTP* to LC Duplex – 10Gig™ OM3 Multimode Plenum Hydra Cable Assemblies			
FHPX126LM005N	Male MTP* to LC duplex 12-fiber 10Gig™ 50/125µm OM3 Multimode Plenum Rated Hydra Cable Assembly with std. 24" (61cm) breakout length.	5	1
FHPX126LM010N	Male MTP* to LC duplex 12-fiber 10Gig™ 50/125µm OM3 Multimode Plenum Rated Hydra Cable Assembly with std. 24" (61cm) breakout length.	10	1
FHPX126LM015N	Male MTP* to LC duplex 12-fiber 10Gig™ 50/125µm OM3 Multimode Plenum Rated Hydra Cable Assembly with std. 24" (61cm) breakout length.	15	1
FHPX126LM020N	Male MTP* to LC duplex 12-fiber 10Gig™ 50/125µm OM3 Multimode Plenum Rated Hydra Cable Assembly with std. 24" (61cm) breakout length.	20	1
Male MTP* to LC Duplex – OM2 Multimode Plenum Hydra Cable Assemblies			
FHP5126LM005N	Male MTP* to LC duplex 12-fiber 50/125µm OM2 multimode plenum rated hydra cable assembly with std. 24" (61 cm) breakout length.	5	1
FHP5126LM010N	Male MTP* to LC duplex 12-fiber 50/125µm OM2 multimode plenum rated hydra cable assembly with std. 24" (61 cm) breakout length.	10	1
FHP5126LM015N	Male MTP* to LC duplex 12-fiber 50/125µm OM2 multimode plenum rated hydra cable assembly with std. 24" (61 cm) breakout length.	15	1
FHP5126LM020N	Male MTP* to LC duplex 12-fiber 50/125µm OM2 multimode plenum rated hydra cable assembly with std. 24" (61 cm) breakout length.	20	1
Male MTP* to LC Duplex – OS1/OS2 Singlemode Plenum Hydra Cable Assemblies			
FHP9126LM005N	Male MTP* to LC duplex 12-fiber 9/125µm OS1/OS2 singlemode plenum rated hydra cable assembly with std. 24" (61cm) breakout length.	5	1
FHP9126LM010N	Male MTP* to LC duplex 12-fiber 9/125µm OS1/OS2 singlemode plenum rated hydra cable assembly with std. 24" (61cm) breakout length.	10	1
FHP9126LM015N	Male MTP* to LC duplex 12-fiber 9/125µm OS1/OS2 singlemode plenum rated hydra cable assembly with std. 24" (61cm) breakout length.	15	1
FHP9126LM020N	Male MTP* to LC duplex 12-fiber 9/125µm OS1/OS2 singlemode plenum rated hydra cable assembly with std. 24" (61cm) breakout length.	20	1

^Additional lengths and availability: The above lengths and configurations are stock items. For other lengths or configurations, contact Customer Service for actual lead times.

Individual Staggered Hydra Cable Assemblies are available. Please see WW-FBCB38.

MTP* Connector Cleaning Tools are available.

*MTP is a registered trademark of US Conec Ltd.

Cable Self-Laminating Labels for QuickNet™ Hydra Cable Assemblies

Suggested Label Solutions for TIA/EIA-606-A Compliance				
Part Number	Laser/Ink Jet Desktop Printer Label	TDP43ME Thermal Transfer Desktop Printer Label	PanTher™ LS8E Hand-Held Printer Label	Cougar™ LS9 Hand-Held Printer Label
All FHP parts	S100X160YAJ and NWSLC-3Y‡	S100X150VATY and NWSLC-3Y‡	S100X160VAC and NWSLC-3Y‡	T100X000CBC-BK and NWSLC-3Y‡

For complete labeling solutions and product information, reference charts on pages O.1 – O.18.
‡For complete information on fiber optic cable identification solutions, reference page C.92.

QuickNet™ MTP* Interconnect Cable Assemblies – Multimode 10Gig™ 50/125µm (OM3 and OM4)

- Pass all TIA/EIA-568-B.3 performance requirements
- FOCIS-5 compliant
- Insertion loss per mated pair: 0.50dB typical; 0.75dB max.
- Tested per IEEE 802.3ae 10 GbE to support network transmission speeds up to 10 Gb/s for link lengths up to 300 meters for OM3 and up to 550 meters for OM4 at 850nm with 50/125µm (OM3 and OM4) laser optimized fiber

- Backward compatible with all 50/125µm (OM2) MPO or MTP* system requirements
- Factory terminated and 100% tested for insertion loss
- Insertion loss and return loss data recorded for every 10Gig™ Multimode Interconnect Cable Assembly
- Lifetime traceability of test data to a Q.C. number on each cable assembly



Part Number	Part Description	Length (m) [^]	Std. Pkg. Qty.	Std. Ctn. Qty.
MTP* Interconnect Cable Assemblies – Multimode 10Gig™ OM4 50/125µm				
FZ12D5-5M1Y	12 Fiber 10Gig™ OM4 Optimized Flat Ribbon Plenum Rated Female MTP - Female MTP Interconnect Cable Assemblies with .5dB IL - 1m	1	1	10
MTP* Interconnect Cable Assemblies – Multimode 10Gig™ OM3 50/125µm				
FX12D5-5M1Y	Female MTP* to female MTP* 12-fiber interconnect cable assembly (one female MTP* connector on each end on ribbon interconnect cable) – 10Gig™ 50/125µm. Outside diameter: 5mm x 2.5mm.	1	1	10

For OM4 interconnect assembly, replace the X (FX12D5-5M1Y) with Z (FZ12D5-5M1Y).

[^]Additional lengths and availability: Interconnect cable assemblies are available in 1 – 10 meter lengths in 1 meter increments, and 15, 20, 25 and 30 meter lengths. To order lengths other than 1 meter, replace the 1 after the M (FZ12D5-5M1) with the desired length (FZ12D5-5M2 for 2 meter length). The above lengths are stock items. For other lengths or male MTPs*, contact Customer Service for actual lead times.

For MTP* Connector Cleaning Tools, see page C.105.

*MTP is a registered trademark of US Conec Ltd.

Cable Labels for QuickNet™ MTP* Interconnect Cable Assemblies – Multimode 10Gig™ 50/125µm (OM3)

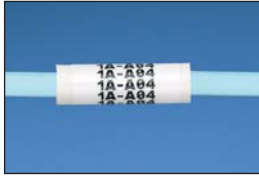

Suggested Label Solutions for TIA/EIA-606-A Compliance				
Patch Cord Part Number	Laser/Ink Jet Desktop Printer Label	TDP43ME Thermal Transfer Desktop Printer Label	PanTher™ LS8E Hand-Held Printer Label	Cougar™ LS9 Hand-Held Printer Label
FX12D5-5M*Y	S100X220YAJ and NWSLC-7Y‡	S100X225VATY and NWSLC-7Y‡	S100X220VAC and NWSLC-7Y‡	T100X000CBC-BK and NWSLC-7Y

For complete labeling solutions and product information, reference charts on pages O.1 – O.18.

‡For complete information on fiber optic cable identification solutions, reference page C.92.

*MTP is a registered trademark of US Conec Ltd.

QuickNet™ MTP* Interconnect Cable Assemblies – Multimode 50/125µm (OM2)

- Pass all TIA/EIA-568-B.3 performance requirements
- FOCIS-5 compliant
- Insertion loss per mated pair: 0.50dB typical; 0.75dB max.
- Factory terminated and 100% tested for insertion loss
- Insertion loss data recorded for every multimode cable assembly
- Lifetime traceability of test data to a Q.C. number on each cable assembly



Part Number	Part Description	Length (m)^	Std. Pkg. Qty.	Std. Ctn. Qty.
F512D5-5M1Y	Female MTP* to female MTP* 12-fiber interconnect cable assembly (one female MTP* connector on each end on ribbon interconnect cable) – 50/125µm.	1	1	10

^Additional lengths and availability: Interconnect cable assemblies are available in 1 – 10 meter lengths in 1 meter increments, and 15, 20, 25 and 30 meter lengths. To order lengths other than 1 meter, replace the 1 after the M (F512D5-5M1Y) with the desired length (F512D5-5M2Y for 2 meter length). The above lengths are stock items. For other lengths or male MTPs*, contact Customer Service for actual lead times.

For MTP* Connector Cleaning Tools, see page C.107.

*MTP is a registered trademark of US Conec Ltd.

Cable Labels for QuickNet™ MTP* Interconnect Cable Assemblies – Multimode 50/125µm (OM2)



Suggested Label Solutions for TIA/EIA-606-A Compliance				
Cable Assembly Part Number	Laser/Ink Jet Desktop Printer Label	TDP43ME Thermal Transfer Desktop Printer Label	PanTher™ LS8E Hand-Held Printer Label	Cougar™ LS9 Hand-Held Printer Label
F512D5-5M*Y	S100X220YAJ and NWSLC-7Y‡	S100X225VATY and NWSLC-7Y‡	S100X220VAC and NWSLC-7Y‡	T100X000CBC-BK and NWSLC-7Y

For complete labeling solutions and product information, reference charts on pages O.1 – O.18.

‡For complete information on fiber optic cable identification solutions, reference page C.92.

*MTP is a registered trademark of US Conec Ltd.

**F612D5-5M*Y**

QuickNet™ MTP* Interconnect Cable Assemblies – Multimode 62.5/125µm (OM1)

- Pass all TIA/EIA-568-B.3 performance requirements
- FOCIS-5 compliant
- Insertion loss per mated pair: 0.50dB typical; 0.75dB max.
- Factory terminated and 100% tested for insertion loss
- Insertion loss data recorded for every multimode cable assembly
- Lifetime traceability of test data to a Q.C. number on each cable assembly

Part Number	Part Description	Length (m) [^]	Std. Pkg. Qty.	Std. Ctn. Qty.
4-Fiber Interconnect Cable Assembly – Female MTP* to Female MTP*				
F64D5-5M1Y	Female MTP* to female MTP* 4-fiber interconnect cable assembly (one female MTP* connector on each end on ribbon interconnect cable) – 62.5/125µm. Outside diameter: 5mm x 2.5mm.	1	1	10
6-Fiber Interconnect Cable Assembly – Female MTP* to Female MTP*				
F66D5-5M1Y	Female MTP* to female MTP* 6-fiber interconnect cable assembly (one female MTP* connector on each end on ribbon interconnect cable) – 62.5/125µm. Outside diameter: 5mm x 2.5mm.	1	1	10
8-Fiber Interconnect Cable Assembly – Female MTP* to Female MTP*				
F68D5-5M1Y	Female MTP* to female MTP* 8-fiber interconnect cable assembly (one female MTP* connector on each end on ribbon interconnect cable) – 62.5/125µm. Outside diameter: 5mm x 2.5mm.	1	1	10
12-Fiber Interconnect Cable Assembly – Female MTP* to Female MTP*				
F612D5-5M1Y	Female MTP* to female MTP* twelve strand fiber optic cable assembly (one female MTP* connector on each end on ribbon interconnect cable) 62.5/125µm. Outside diameter: 5mm x 2.5mm.	1.0	1	10

[^]Additional lengths and availability: 12-fiber interconnect cable assemblies are available in 1 – 10 meter lengths in 1 meter increments, and 15, 20, 25 and 30 meter lengths. All other cable assemblies above are available in 1, 2, 3 and 10 meter lengths. To order lengths other than 1 meter, replace the 1 after the M (F612D5-5M1Y) with the desired length (F612D5-5M2Y for 2 meter length). The above lengths are stock items. For other lengths or male MTPs*, contact Customer Service for actual lead times.

For MTP* Connector Cleaning Tools, see page C.107.

*MTP is a registered trademark of US Conec Ltd.

Cable Labels for QuickNet™ MTP* Interconnect Cable Assemblies – Multimode 62.5/125µm (OM1)



Suggested Label Solutions for TIA/EIA-606-A Compliance

Cable Assembly Part Number	Laser/Ink Jet Desktop Printer Label	TDP43ME Thermal Transfer Desktop Printer Label	PanTher™ LS8 Hand-Held Printer Label	Cougar™ LS9 Hand-Held Printer Label
All MTP* Interconnect Cable Assemblies on this page	S100X220YAJ and NWSLC-7Y‡	S100X225VATY and NWSLC-7Y‡	S100X220VAC and NWSLC-7Y‡	T100X000CBC-BK and NWSLC-7Y

For complete labeling solutions and product information, reference charts on pages O.1 – O.18.

‡For complete information on fiber optic cable identification solutions, reference page C.92.

*MTP is a registered trademark of US Conec Ltd.

QuickNet™ MTP* Interconnect Cable Assemblies – Singlemode 9/125µm (OS1/OS2)

- Pass all TIA/EIA-568-B.3 performance requirements
- FOCIS-5 compliant
- 100% factory inspected end face geometry (SC, ST, and FJ® end faces are 100% inspected in compliance with Telcordia GR-326-CORE, Issue 3)
- Insertion loss per mated pair: 0.50dB typical; 0.75dB max.
- 8-degree APC polish (55dB minimum Return Loss) on singlemode MTP* and UPC polish (55dB minimum Return Loss) on singlemode SC, ST, and FJ® satisfy high-speed network application requirements
- Factory terminated and 100% tested for insertion loss and return loss
- Insertion loss and return loss data recorded for every singlemode cable assembly
- Lifetime traceability of test data to a Q.C. number on each cable assembly



F912D5-5M*Y

Part Number	Part Description	Length (m)^	Std. Pkg. Qty.	Std. Ctn. Qty.
4-Fiber Interconnect Cable Assembly – Female MTP* to Female MTP*				
F94D5-5M1Y	Female MTP* to female MTP* 4-fiber interconnect cable assembly (one female MTP* connector on each end on ribbon interconnect cable) – 9/125µm. Outside diameter: 5mm x 2.5mm.	1	1	10
6-Fiber Interconnect Cable Assembly – Female MTP* to Female MTP*				
F96D5-5M1Y	Female MTP* to female MTP* 6-fiber interconnect cable assembly (one female MTP* connector on each end on ribbon interconnect cable) – 9/125µm. Outside diameter: 5mm x 2.5mm.	1	1	10
8-Fiber Interconnect Cable Assembly – Female MTP* to Female MTP*				
F98D5-5M1Y	Female MTP* to female MTP* 8-fiber interconnect cable assembly (one female MTP* connector on each end on ribbon interconnect cable) – 9/125µm. Outside diameter: 5mm x 2.5mm.	1	1	10
12-Fiber Interconnect Cable Assembly – Female MTP* to Female MTP*				
F912D5-5M1Y	Female MTP* to female MTP* twelve strand fiber optic cable assembly (one female MTP* connector on each end on ribbon interconnect cable) 9/125µm. Outside diameter: 5mm x 2.5mm.	1.0	1	10

^Additional lengths and availability: 12-fiber interconnect cable assemblies are available in 1 – 10 meter lengths in 1 meter increments, and 15, 20, 25 and 30 meter lengths. All other cable assemblies above are available in 1, 2, 3 and 10 meter lengths. To order lengths other than 1 meter, replace the 1 after the M (F912D5-5M1Y) with the desired length (F912D5-5M2Y for 2 meter length). The above lengths are stock items. For other lengths or male MTPs*, contact Customer Service for actual lead times.

For MTP* Connector Cleaning Tools, see page C.107.

*MTP is a registered trademark of US Conec Ltd.

Cable Labels for QuickNet™ MTP* Interconnect Cable Assemblies – Singlemode 9/125µm (OS1/OS2)



Suggested Label Solutions for TIA/EIA-606-A Compliance				
Cable Assembly Part Number	Laser/Ink Jet Desktop Printer Label	TDP43ME Thermal Transfer Desktop Printer Label	PanTher™ LS8E Hand-Held Printer Label	Cougar™ LS9 Hand-Held Printer Label
All MTP* Interconnect Cable Assemblies	S100X220YAJ and NWSLC-7Y‡	S100X225VATY and NWSLC-7Y‡	S100X220VAC and NWSLC-7Y‡	T100X000CBC-BK and NWSLC-7Y

For complete labeling solutions and product information, reference charts on pages O.1 – O.18.

‡For complete information on fiber optic cable identification solutions, reference page C.92.

*MTP is a registered trademark of US Conec Ltd.

NEW!**QuickNet™ MTP* Interconnect Round Cable Assemblies – Multimode 10Gig™ 50/125µm (OM3 and OM4)**

- Pass all TIA/EIA-568-B.3 performance requirements
- FOCIS-5 compliant
- Insertion loss per mated pair: 0.50dB typical; 0.75dB max.
- Tested per IEEE 802.3ae 10 GbE to support network transmission speeds up to 10 Gb/s for link lengths up to 300 meters for OM3 and up to 550 meters for OM4 at 850nm with 50/125µm (OM3 and OM4) laser optimized fiber
- Backward compatible with all 50/125µm (OM2) MPO or MTP* system requirements
- Factory terminated and 100% tested for insertion loss
- Insertion loss and return loss data recorded for every 10Gig™ Multimode Interconnect Round Cable Assembly
- Lifetime traceability of test data to a Q.C. number on each cable assembly



FXN0505RTPM*

Part Number	Part Description	Color	Std. Pkg. Qty.	Std. Ctn. Qty.
MTP* Interconnect Round Cable Assemblies – 10Gig™ OM4				
FZN0505RTPM001	12-fiber OM4 plenum rated female MTP*/MPO – female MTP*/MPO interconnect round cable assembly.	Aqua	1	10
MTP* Interconnect Round Cable Assemblies – 10Gig™ OM3				
FXN0505RTPM001	12-fiber OM3 plenum rated female MTP*/MPO – female MTP*/MPO interconnect round cable assembly.	Aqua	1	10
Optimized MTP* Interconnect Round Cable Assemblies – 10Gig™ OM4				
FZP0505RTPM001	12-fiber OM4 optimized plenum rated female MTP*/MPO – female MTP*/MPO interconnect round cable assembly.	Aqua	1	10
Optimized MTP* Interconnect Round Cable Assemblies – 10Gig™ OM3				
FXP0505RTPM001	12-fiber OM3 optimized plenum rated female MTP*/MPO – female MTP*/MPO interconnect round cable assembly.	Aqua	1	10

*Additional lengths and availability: Interconnect round cable assemblies are available from 1 to 100ft. in 1ft. increments and available from 1 to 50m in 1m increments. To order lengths other than 1ft or meter, replace the 1 after the F or M with the desired length. Ex: FZN0505RTPM001 to FZN0505RTPM002 for 2 meter length. Interconnect round cable assemblies are also available in LSZH (low smoke zero halogen).

For MTP* Connector Cleaning Tools, see page C.105.

*MTP is a registered trademark of US Conec Ltd.

NEW!**QuickNet™ MTP* Interconnect Round Cable Assemblies – Singlemode 9µm (OS1/OS2)**

- Pass all TIA/EIA-568-B.3 performance requirements
- FOCIS-5 compliant
- 100% factory inspected end face geometry is 100% inspected in compliance with Telcordia GR-326-CORE, Issue 3)
- Insertion loss per mated pair: 0.50dB typical; 0.75dB max.
- 8-degree APC polish (55dB minimum Return Loss) on singlemode MTP* satisfies high-speed network application requirements
- Factory terminated and 100% tested for insertion loss and return loss
- Insertion loss and return loss data recorded for every singlemode cable assembly
- Lifetime traceability of test data to a Q.C. number on each cable assembly



Part Number	Part Description	Color	Std. Pkg. Qty.	Std. Ctn. Qty.
MTP* Interconnect Round Cable Assemblies – Singlemode 9µm OS1/OS2				
F9N0505RTPM001	12-fiber 9µm plenum rated female MTP*/MPO – female MTP*/MPO interconnect round cable assembly.	Yellow	1	10

*Additional lengths and availability: Interconnect round cable assemblies are available from 1 to 100ft. in 1ft. increments and available from 1 to 50m in 1m increments. To order lengths other than 1ft or meter, replace the 1 after the F or M with the desired length. Ex: F9N0505RTPM001 to F9N0505RTPM002 for 2 meter length. Interconnect round cable assemblies are also available in LSZH (low smoke zero halogen).

For MTP* Connector Cleaning Tools, see page C.105.

*MTP is a registered trademark of US Conec Ltd.

QuickNet™ MTP* Trunk Cable Assemblies

- Connectivity meets or exceeds TIA/EIA-568-B.3 and ISO/IEC 11801 performance requirements
- Jacketed cable is compliant with NFPA 262 (OFNP) flame rating
- MTP* (12-fiber) connectors are FOCIS-5 compliant
- Insertion loss per mated pair: 0.50dB typical, 0.75dB max.
- Panduit proprietary MTP* polishing provides low insertion loss and high return loss, minimizing variability for improved channel link loss performance
- Factory terminated and 100% tested for insertion loss (test data supplied with each assembly); singlemode and 10Gig™ Multimode Trunk Cable Assemblies are also tested for return loss
- TIA/EIA-568-B.1-7 (Method A) standards based polarity supports 10 Gb/s, multimode, and singlemode fiber types, and allows infrastructure backwards compatibility for component interchangeability and a lower cost of ownership
- 10Gig™ laser optimized fiber is tested per IEEE 802.3ae 10 GbE to support network transmission speeds up to 10 Gb/s for link lengths up to 300 meters at 850nm
- Application specific designs available to tailor configuration, reach, and breakout construction to application requirements; for more information contact Panduit or visit www.panduit.com



FSPX2455F***A

Part Number	Part Description	Length (Ft.) [^]	Std. Pkg. Qty.
Female MTP* to Female MTP* – 10Gig™ OM3 Multimode Plenum Trunk Cable Assemblies			
FSPX1255F100A	Female MTP* to female MTP* 12-fiber 10Gig™ 50/125µm OM3 Multimode Plenum Rated Trunk Cable Assembly with pulling eye on one end.	100	1
FSPX1255F150A	Female MTP* to female MTP* 12-fiber 10Gig™ 50/125µm OM3 Multimode Plenum Rated Trunk Cable Assembly with pulling eye on one end.	150	1
FSPX1255F200A	Female MTP* to female MTP* 12-fiber 10Gig™ 50/125µm OM3 Multimode Plenum Rated Trunk Cable Assembly with pulling eye on one end.	200	1
FSPX2455F100A	Female MTP* to female MTP* 24-fiber 10Gig™ 50/125µm OM3 Multimode Plenum Rated Trunk Cable Assembly with pulling eye on one end.	100	1
FSPX2455F150A	Female MTP* to female MTP* 24-fiber 10Gig™ 50/125µm OM3 Multimode Plenum Rated Trunk Cable Assembly with pulling eye on one end.	150	1
FSPX2455F200A	Female MTP* to female MTP* 24-fiber 10Gig™ 50/125µm OM3 Multimode Plenum Rated Trunk Cable Assembly with pulling eye on one end.	200	1
FSPX4855F100A	Female MTP* to female MTP* 48-fiber 10Gig™ 50/125µm OM3 Multimode Plenum Rated Trunk Cable Assembly with pulling eye on one end.	100	1
FSPX4855F150A	Female MTP* to female MTP* 48-fiber 10Gig™ 50/125µm OM3 Multimode Plenum Rated Trunk Cable Assembly with pulling eye on one end.	150	1
FSPX4855F200A	Female MTP* to female MTP* 48-fiber 10Gig™ 50/125µm OM3 Multimode Plenum Rated Trunk Cable Assembly with pulling eye on one end.	200	1

[^]Additional lengths and availability: The above lengths and configurations are stock items. For other lengths or configurations, contact Customer Service for actual lead times.

For MTP* Connector Cleaning Tools, see page C.109.

*MTP is a registered trademark of US Conec Ltd.

Additional lengths and availability: Trunk cable assemblies are available from 40 to 200 ft. in 5 ft. increments in OM3 and OM4 plenum rated. Ex: FSPX1255F040A (40ft. length) to FSPX1255F100A 100ft. length.)

Table continues on page C.98

QuickNet™ MTP* Trunk Cable Assemblies (continued)**FSP52455F***A**

Part Number	Part Description	Length (Ft.) [^]	Std. Pkg. Qty.
Female MTP* to Female MTP* – OM2 Multimode Plenum Trunk Cable Assemblies			
FSP51255F100A	Female MTP* to female MTP* 12-fiber 50/125µm OM2 multimode plenum rated trunk cable assembly with pulling eye on one end.	100	1
FSP51255F150A	Female MTP* to female MTP* 12-fiber 50/125µm OM2 multimode plenum rated trunk cable assembly with pulling eye on one end.	150	1
FSP51255F200A	Female MTP* to female MTP* 12-fiber 50/125µm OM2 multimode plenum rated trunk cable assembly with pulling eye on one end.	200	1
FSP52455F100A	Female MTP* to female MTP* 24-fiber 50/125µm OM2 multimode plenum rated trunk cable assembly with pulling eye on one end.	100	1
FSP52455F150A	Female MTP* to female MTP* 24-fiber 50/125µm OM2 multimode plenum rated trunk cable assembly with pulling eye on one end.	150	1
FSP52455F200A	Female MTP* to female MTP* 24-fiber 50/125µm OM2 multimode plenum rated trunk cable assembly with pulling eye on one end.	200	1
FSP54855F100A	Female MTP* to female MTP* 48-fiber 50/125µm OM2 multimode plenum rated trunk cable assembly with pulling eye on one end.	100	1
FSP54855F150A	Female MTP* to female MTP* 48-fiber 50/125µm OM2 multimode plenum rated trunk cable assembly with pulling eye on one end.	150	1
FSP54855F200A	Female MTP* to female MTP* 48-fiber 50/125µm OM2 multimode plenum rated trunk cable assembly with pulling eye on one end.	200	1
Female MTP* to Female MTP* – OS1/OS2 Singlemode Plenum Trunk Cable Assemblies			
FSP91255F100A	Female MTP* to female MTP* 12-fiber 9/125µm OS1/OS2 singlemode plenum rated trunk cable assembly with pulling eye on one end.	100	1
FSP91255F150A	Female MTP* to female MTP* 12-fiber 9/125µm OS1/OS2 singlemode plenum rated trunk cable assembly with pulling eye on one end.	150	1
FSP91255F200A	Female MTP* to female MTP* 12-fiber 9/125µm OS1/OS2 singlemode plenum rated trunk cable assembly with pulling eye on one end.	200	1
FSP92455F100A	Female MTP* to female MTP* 24-fiber 9/125µm OS1/OS2 singlemode plenum rated trunk cable assembly with pulling eye on one end.	100	1
FSP92455F150A	Female MTP* to female MTP* 24-fiber 9/125µm OS1/OS2 singlemode plenum rated trunk cable assembly with pulling eye on one end.	150	1
FSP92455F200A	Female MTP* to female MTP* 24-fiber 9/125µm OS1/OS2 singlemode plenum rated trunk cable assembly with pulling eye on one end.	200	1
FSP94855F100A	Female MTP* to female MTP* 48-fiber 9/125µm OS1/OS2 singlemode plenum rated trunk cable assembly with pulling eye on one end.	100	1
FSP94855F150A	Female MTP* to female MTP* 48-fiber 9/125µm OS1/OS2 singlemode plenum rated trunk cable assembly with pulling eye on one end.	150	1
FSP94855F200A	Female MTP* to female MTP* 48-fiber 9/125µm OS1/OS2 singlemode plenum rated trunk cable assembly with pulling eye on one end.	200	1

[^]Additional lengths and availability: The above lengths and configurations are stock items. For other lengths or configurations, contact Customer Service for actual lead times.

For MTP* Connector Cleaning Tools, see page C.107.

*MTP is a registered trademark of US Conec Ltd.

Opti-Core® Traditional Trunk Cable Assemblies

- Connectivity meets or exceeds TIA/EIA-568-B.3 and ISO/IEC 11801 performance requirements
- LC and SC connector housing and boot colors follow TIA/EIA-568-C.3 suggested color identification scheme
- Jacketed cable is compliant with UL1666 (OFNR) or NFPA 262 (OFNP) flame rating
- Insertion loss per mated pair: 0.10dB typical, 0.30dB max. (multimode); 0.25dB typical, 0.50dB max. (singlemode)
- Traditional connectors (Panduit LC, SC, and ST) provide design flexibility throughout the data center
- Factory terminated and 100% tested for insertion loss (test data supplied with each assembly); singlemode and 10Gig™ Multimode Trunk Cable Assemblies are also tested for return loss
- 10Gig™ laser optimized fiber is tested per IEEE 802.3ae 10 GbE to support network transmission speeds up to 10 Gb/s for link lengths up to 300 meters at 850nm
- Application specific designs available to tailor configuration, reach, and breakout construction to application requirements; for more information contact Panduit or visit www.panduit.com



FSP51211F***A

Part Number	Part Description	Length (Ft.) [^]	Std. Pkg. Qty.
LC to LC Simplex – 10Gig™ OM3 Multimode Plenum Trunk Cable Assemblies			
FSPX1211F100A	LC to LC simplex 12-fiber 10Gig™ 50/125µm OM3 Multimode Plenum Rated Trunk Cable Assembly with pulling eye on one end.	100	1
FSPX1211F150A	LC to LC simplex 12-fiber 10Gig™ 50/125µm OM3 Multimode Plenum Rated Trunk Cable Assembly with pulling eye on one end.	150	1
FSPX1211F200A	LC to LC simplex 12-fiber 10Gig™ 50/125µm OM3 Multimode Plenum Rated Trunk Cable Assembly with pulling eye on one end.	200	1
FSPX2411F100A	LC to LC simplex 24-fiber 10Gig™ 50/125µm OM3 Multimode Plenum Rated Trunk Cable Assembly with pulling eye on one end.	100	1
FSPX2411F150A	LC to LC simplex 24-fiber 10Gig™ 50/125µm OM3 Multimode Plenum Rated Trunk Cable Assembly with pulling eye on one end.	150	1
FSPX2411F200A	LC to LC simplex 24-fiber 10Gig™ 50/125µm OM3 Multimode Plenum Rated Trunk Cable Assembly with pulling eye on one end.	200	1
FSPX4811F100A	LC to LC simplex 48-fiber 10Gig™ 50/125µm OM3 Multimode Plenum Rated Trunk Cable Assembly with pulling eye on one end.	100	1
FSPX4811F150A	LC to LC simplex 48-fiber 10Gig™ 50/125µm OM3 Multimode Plenum Rated Trunk Cable Assembly with pulling eye on one end.	150	1
FSPX4811F200A	LC to LC simplex 48-fiber 10Gig™ 50/125µm OM3 Multimode Plenum Rated Trunk Cable Assembly with pulling eye on one end.	200	1

[^]Additional lengths and availability: The above lengths and configurations are stock items. For other lengths or configurations, contact Customer Service for actual lead times.

Table continues on page C.100

Opti-Core[®] Traditional Trunk Cable Assemblies (continued)

Part Number	Part Description	Length (Ft.) [^]	Std. Pkg. Qty.
LC to LC Simplex – OM2 Multimode Plenum Trunk Cable Assemblies			
FSP51211F100A	LC to LC simplex 12-fiber 50/125µm OM2 multimode plenum rated trunk cable assembly with pulling eye on one end.	100	1
FSP51211F150A	LC to LC simplex 12-fiber 50/125µm OM2 multimode plenum rated trunk cable assembly with pulling eye on one end.	150	1
FSP51211F200A	LC to LC simplex 12-fiber 50/125µm OM2 multimode plenum rated trunk cable assembly with pulling eye on one end.	200	1
FSP52411F100A	LC to LC simplex 24-fiber 50/125µm OM2 multimode plenum rated trunk cable assembly with pulling eye on one end.	100	1
FSP52411F150A	LC to LC simplex 24-fiber 50/125µm OM2 multimode plenum rated trunk cable assembly with pulling eye on one end.	150	1
FSP52411F200A	LC to LC simplex 24-fiber 50/125µm OM2 multimode plenum rated trunk cable assembly with pulling eye on one end.	200	1
FSP54811F100A	LC to LC simplex 48-fiber 50/125µm OM2 multimode plenum rated trunk cable assembly with pulling eye on one end.	100	1
FSP54811F150A	LC to LC simplex 48-fiber 50/125µm OM2 multimode plenum rated trunk cable assembly with pulling eye on one end.	150	1
FSP54811F200A	LC to LC simplex 48-fiber 50/125µm OM2 multimode plenum rated trunk cable assembly with pulling eye on one end.	200	1
LC to LC Simplex – OS1/OS2 Singlemode Plenum Trunk Cable Assemblies			
FSP91211F100A	LC to LC simplex 12-fiber 9/125µm OS1/OS2 singlemode plenum rated trunk cable assembly with pulling eye on one end.	100	1
FSP91211F150A	LC to LC simplex 12-fiber 9/125µm OS1/OS2 singlemode plenum rated trunk cable assembly with pulling eye on one end.	150	1
FSP91211F200A	LC to LC simplex 12-fiber 9/125µm OS1/OS2 singlemode plenum rated trunk cable assembly with pulling eye on one end.	200	1
FSP92411F100A	LC to LC simplex 24-fiber 9/125µm OS1/OS2 singlemode plenum rated trunk cable assembly with pulling eye on one end.	100	1
FSP92411F150A	LC to LC simplex 24-fiber 9/125µm OS1/OS2 singlemode plenum rated trunk cable assembly with pulling eye on one end.	150	1
FSP92411F200A	LC to LC simplex 24-fiber 9/125µm OS1/OS2 singlemode plenum rated trunk cable assembly with pulling eye on one end.	200	1
FSP94811F100A	LC to LC simplex 48-fiber 9/125µm OS1/OS2 singlemode plenum rated trunk cable assembly with pulling eye on one end.	100	1
FSP94811F150A	LC to LC simplex 48-fiber 9/125µm OS1/OS2 singlemode plenum rated trunk cable assembly with pulling eye on one end.	150	1
FSP94811F200A	LC to LC simplex 48-fiber 9/125µm OS1/OS2 singlemode plenum rated trunk cable assembly with pulling eye on one end.	200	1

[^]Additional lengths and availability: The above lengths and configurations are stock items. For other lengths or configurations, contact Customer Service for actual lead times.

OptiCam® Pre-Polished Cam Fiber Optic Termination Kits

- For termination of all Panduit® OptiCam® Pre-Polished Connectors
- OptiCam® Termination Tool simplifies tooling and termination, and virtually eliminates operator error by providing visual indication of proper termination after the cam step has been completed
- No adhesive or electricity required for termination
- Include installation instructions and stripping templates for all Panduit® OptiCam® Pre-Polished Connectors; also available on www.panduit.com



FCAMKIT



FPPKIT-CVY

Part Number	Part Description	Std. Pkg. Qty.
OptiCam® Pre-Polished Cam Termination Kit		
FCAMKIT	Tools, consumables, installation instructions and stripping templates necessary for termination of all Panduit® OptiCam® Pre-Polished Cam Connectors.	1
OptiCam® Conversion Kit – Converts Opti-Crimp® Termination Kit for OptiCam® Termination		
FPPKIT-CVY	Converts Opti-Crimp® Termination Kits with the additional tools, installation instructions, and stripping templates required for termination of all Panduit® OptiCam® Pre-Polished Cam Connectors; includes OptiCam® Termination Tool and cradles, and FVFLPC-2.5SMY and FVFLPC-1.25SMY patch cords.	1
Cleaning Consumables Kit		
FCLEANKIT	Replenishes the cleaning consumables required for termination of all fiber optic connectors; includes all of the same cleaning consumable items that are included in all Panduit termination kits.	1
Field Polish Kit Upgrade for OptiCam® Connector Termination		
FIELDKITUPG	Upgrades FIELDKIT with the additional tools, consumables, installation instructions and stripping templates required for termination of all Panduit® OptiCam® Pre-Polished Cam Connectors.	1

For field polish termination kits, see page C.103, C.104.

Components for OptiCam® Pre-Polished Cam Termination Kits



OCTT



Part Number	Part Description	Std. Pkg. Qty.	Std. Ctn. Qty.
Tools (included in FCAMKIT)			
FKITCASE	Case for fiber termination kits.	1	—
CST115	Fiber cable jacket stripper.	1	—
FALC	Alcohol bottle (empty).	1	10
FBFSP	Fiber buffer stripper.	1	10
FSCDVR	Screwdriver.	1	50
FGLS	Safety glasses.	1	10
FTWZR	Tweezers.	1	10
FWBTL	Water bottle (empty).	1	10
FKS	Fiber Kevlar shears.	1	10
FWRKMAT	Fiber safe workmat.	1	10
Tools (included in FCAMKIT and FIELDKITUPG)			
FJQCVR	Fiber cleaver tool.	1	10
OCTT	OptiCam® Termination Tool; includes batteries, pouch, and two cradles for each OptiCam® Connector – LC, SC, and ST (patch cords available separately).	1	—
FVFLPC-2.5SMY	Patch cord for all OptiCam® 2.5mm ferrule connectors (SC & ST).	1	10
FVFLPC-1.25SMY	Patch cord for all OptiCam® 1.25mm ferrule connectors (LC).	1	10
Cleaning Consumables (included in FCAMKIT and FCLEANKIT)			
FWP-C	Lint-free wipes.	100	1000
FSWB-C	Cleaning swabs.	100	1000
FSTY	Safety stickers for fiber scraps.	1	10
PFX-0	Permanent marking pen, fine tip, black ink (one included in each kit).	12	144
Replacement Parts			
FJQCVRB	Replacement blade for FJQCVR.	1	10
FSCC	Tool cradles for SC OptiCam® Connectors (two per package).	1	—
FLCC	Tool cradles for LC OptiCam® Connectors (two per package).	1	—
FSTC	Tool cradles for ST OptiCam® Connectors (two per package).	1	—

Field Polish Fiber Optic Termination Kits

- For termination of all Panduit field polish connectors
- Fast acting adhesive; no long curing epoxy required for termination
- Kit provides consumables for terminating up to 200 field polish connectors
- Include installation instructions and stripping templates for all Panduit field polish connectors; also available on www.panduit.com

**FIELDKIT**

Part Number	Part Description	Std. Pkg. Qty.
Field Polish Termination Kits		
FIELDKIT	Tools, consumables, installation instructions and stripping templates necessary for termination of all Panduit field polish connectors; includes FHSC heat shrink curing tool – 110VAC, 60Hz.	1
FIELDKIT-G	Tools, consumables, installation instructions and stripping templates necessary for termination of all Panduit field polish connectors; includes FHSC-W heat shrink curing tool – 230VAC, 50Hz.	1
Field Polish Consumables Refurbishment Kit		
FIELDKITRFB	Replenishes the field polish consumables required for termination of all field polish connectors; includes all of the same consumable items as the FIELDKIT or FIELDKIT-G field polish termination kit.	1
Cleaning Consumables Kit		
FCLEANKIT	Replenishes the cleaning consumables required for termination of all fiber optic connectors; includes all of the same cleaning consumable items that are included in all Panduit termination kits.	1
OptiCam[®] Kit Upgrade for Field Polish Connector Termination		
FCAMKITUPG	Upgrades FCAMKIT with the additional tools, consumables, installation instructions and stripping templates required for termination of all Panduit field polish connectors; includes FHSC heat shrink curing tool – 110VAC, 60Hz.	1
FCAMKITUPG-G	Upgrades FCAMKIT with the additional tools, consumables, installation instructions and stripping templates required for termination of all Panduit field polish connectors; includes FHSC-W heat shrink curing tool – 230VAC, 50Hz.	1

For OptiCam[®] Pre-Polished Cam Termination Kits, see page C.101.

Components for Field Polish Fiber Optic Termination Kits

Part Number	Part Description	Std. Pkg. Qty.	Std. Ctn. Qty.
Tools (included in FIELDKIT and FIELDKIT-G)			
FKITCASE	Case for fiber termination kits.	1	—
CST115	Fiber cable jacket stripper.	1	—
FALC	Alcohol bottle (empty).	1	10
FBFSP	Fiber buffer stripper.	1	10
FSCDVR	Screwdriver.	1	50
FGLS	Safety glasses.	1	10
FTWZR	Tweezers.	1	10
FWBTL	Water bottle (empty).	1	10
FKS	Fiber Kevlar shears.	1	10
FWRKMAT	Fiber safe workmat.	1	10
Tools (included in FIELDKIT, FIELDKIT-G, FCAMKITUPG and FCAMKITUPG-G)			
FSCRIBE	Carbide scribe.	1	10
FLCASC	1.25mm adapter for FSCOPE.	1	—
FLOUPEX10	Eye loupe (10x).	1	—
FCRP5	Crimp tool (hex sizes: 0.048", 0.100", 0.128", 0.151", 0.190").	1	—
FLPT	Crimp tool required for 1.6mm/2.0mm jacketed cable termination.	1	—
FJPKGU	Universal polishing puck (2.5mm ferrule).	1	10
FLCPK	LC polishing puck (1.25mm ferrule).	1	—
FPAD	Fiber polishing pad (70 durometer).	1	10
FLCPAD	Polishing pad and plate (85 durometer).	1	10
FHSCT	Heat shrink curing tool (110VAC, 60Hz) required for 1.6mm/2.0mm jacketed cable termination (included in FIELDKIT and FCAMKITUPG).	1	—
FHSCT-W	Heat shrink curing tool (230VAC, 50Hz) required for 1.6mm/2.0mm jacketed cable termination (included in FIELDKIT-G and FCAMKITUPG-G).	1	—
Field Polish Consumables (included in FIELDKIT, FIELDKIT-G, FIELDKITRFB, FCAMKITUPG and FCAMKITUPG-G)			
FSYR-X	Syringes with needle tips.	10	50
FPWIRE	Piano wire.	1	10
LJSL4-Y3-2.5	Cable labels.	1	10
FJPMR	Primer (50ml).	1	10
FJPHY	Anaerobic adhesive (10ml).	1	10
FPP5-L	5µm polishing paper (AL ₂ O ₃).	50	250
FPF1-V	1µm diamond polishing film.	5	50
FLCFPLF-X	0.05µm lapping film.	10	—
Cleaning Consumables (included in FIELDKIT, FIELDKIT-G, FIELDKITRFB and FCLEANKIT)			
FWP-C	Lint-free wipes.	100	1000
FSWB-C	Cleaning swabs.	100	1000
FSTY	Safety stickers for fiber scraps.	1	10
PFX-0	Permanent marking pen – fine tip (one included in each kit).	12	144
Replacement Parts			
FSCRBLD	Replacement blade for carbide scribe.	1	10

MTP* Connector Cleaning Tools

- All tools feature a dry cloth cleaning system with an ultra clean micro-fiber cloth that captures debris and contamination
- Anti-static cloth minimizes additional debris from being attracted to connector surfaces
- Densely woven, robust cloth doesn't fray or leave fibrous materials behind
- Easy-to-install replacement reels are available for reel type MTP* connector cleaning tools (FMTPFCT and FMTPMFCT) for continuous cleaning without the need for tool replacement
- QuickNet™ Cassette MTP* Connector Cleaning Tool is designed to clean MTP* connectors inside QuickNet™ Cassettes, adapters, faceplates or bulkheads
- QuickNet™ Cassette MTP* Connector Cleaning Tool's unique design enables cleaning of male (with pins) or female (without pins) MTP* connectors
- All tools and refills can be used to clean 400 MTP* or MPO connectors

**FMTPFCT****FMTPMFCT****FIBCCT****FMTPRR6**

Part Number	Part Description	Std. Pkg. Qty.
-------------	------------------	----------------

Reel Type MTP* Connector Cleaning Tools

FMTPFCT	Reel type MTP* connector cleaning tool for cleaning MTP* female connectors (without pins).	1
FMTPMFCT	Reel type MTP* connector cleaning tool for cleaning MTP* male connectors (with pins).	1

QuickNet™ Cassette MTP* Connector Cleaning Tool

FIBCCT	QuickNet™ Cassette MTP* connector cleaning tool for cleaning MTP* connectors inside QuickNet™ Cassettes, adapters, faceplates or bulkheads.	1
---------------	---	---

Cleaning Reel Refill for Reel Type MTP* Connector Cleaning Tools

FMTPRR6	Cleaning reel refill for FMTPFCT and FMTPMFCT reel type MTP* connector cleaning tools (includes six reels).	1
----------------	---	---

*MTP is a registered trademark of US Conec Ltd.

Patch Cord Removal Tool

- Tool arms allow the installer to pass over cabling which interferes with accessibility
- Compatible with copper and fiber patch cords in adapter panels, pre-terminated cassettes, and enclosures
- Optional flashlight kit (KPCRT-FL) attaches to top of tool

**PCRT1****KPCRT-FL**

Part Number	Part Description	Std. Pkg. Qty.
-------------	------------------	----------------

PCRT1	Easily removes copper and fiber patch cords in dense rack installations.	1
KPCRT1-FL	Flashlight kit for patch cord removal tool (PCRT1).	1

Opticom® High-Density Connector and Patch Cord Removal Tool

- Provides easy access for inserting and removing connectors to minimize adjacent connector disturbance, especially in high-density applications
- Used with simplex and duplex LC and SC connectors in fiber adapter panels, pre-terminated cassettes, and enclosures
- Tool includes end effectors for LC connectors and a carrying case for storage and transportation
- Removable end effectors for SC or LC connectors and LED light for working in dimly lit areas are available separately



HDCRT



KHDCRT-FL



KHDCRT-SCE

Part Number	Part Description	Std. Pkg. Qty.
Opticom® High-Density Connector Removal Tool		
HDCRT	High-density connector removal tool includes end effector for simplex and duplex LC connectors.	1
Accessories		
KHDCRT-FL	Flashlight kit for HDCRT tool.	1
KHDCRT-SCE	End effector for simplex and duplex SC connectors.	1
KHDCRT-LCE	Replacement end effector for simplex and duplex LC connectors.	1

NOTES

POWER OVER ETHERNET SYSTEMS

As organizations continue to deploy emerging applications such as IP surveillance cameras, IP telephony, wireless access points (WAPs), and intelligent buildings, it is increasingly necessary to seek out cost savings, power management, and network reliability to support these for growing network infrastructures. Utilizing new or existing Ethernet wiring systems to send both data and power together, Power over Ethernet (PoE) offers a cost-effective advancement to resolve these challenges while expanding network infrastructure capabilities.

As a leading provider of PoE technology, Panduit® DPoE™ Power over Ethernet Systems utilize power patch panels in various port and data capability designs, a compact power midspan with 2X power (up to 32 watts), and power systems with low heat dissipation to enable greater network design modularity, simplify installations, and lower total cost of ownership.



- Space-saving designs allow for deployment in space-constrained locations
- Enable network modularity and scalability to grow a network as needed
- Provide redundant powering to reduce risk and diminish downtime
- Deliver low heat dissipation to improve power and cooling costs
- Provide visibility of all powered ports and allows multiple site management with a single graphical user interface

Panduit® DPoE™ Power over Ethernet Systems utilize DPoE™ Patch Panels in various port and data capability designs and DPoE™ Compact 8 Midspan with 2X power (up to 32 watts) for increased capabilities. The DPoE™ Power System provides high efficiency power supplies that can be hot-swapped for field upgrades or for replacement without taking the entire system down. The DPoE™ Element Manager Software automatically locates and provides visibility of all powered ports across the network and allows multiple site management with a single graphical user interface. As a result, Panduit® DPoE™ Power over Ethernet Systems take an innovative approach toward providing scalable and ample power injection for maximum reliability and lower total cost of ownership.

Power over Ethernet Systems Roadmap



1 DPoE™ Power Patch Panel
(page D.3)



2 DPoE™ Power Midspan
(page D.4)



3 DPoE™ Power System
(page D.5)



4 DPoE™ Power
Midspan Accessories
(page D.4)



5 DPoE™ Element Manager



6 DPoE™ Power Supply
(page D.5)



7 PanZone® In-Ceiling
Enclosures
(page E.3)



DPoE™ Power Patch Panel

- Deliver reliable, cost-effective Power over Ethernet for permanent installations
- Combine patching and power in a single device, occupying only one rack space
- Support 15.4 watts to every port
- Fully compliant with IEEE 802.3af standards
- Eliminate power budget load balancing
- Offer RJ45 terminations with LEDs on front of panels to indicate port powering or port status and 110 punchdown terminations on rear of panel for networking management connections
- Dissipate significantly less heat than comparable network equipment
- Require 48V DC power supply



Part Number	Part Description	No. of Rack Spaces [^]	Std. Pkg. Qty.
DPOE24U1XG	24-port UTP 1 GbE 10/100/1000 patch panel supporting IEEE 802.3af-2003 and legacy PoE power protocols. Includes Element Manager software CD, rack mount screws, grounding strap, and lug.	1	1

[^]One rack space = 1.75" (44.45mm).
Strain relief bars for mounting can be found on page B.70.
Power supply and/or power system sold separately.

Component Labels for DPoE™ Power Patch Panel



Suggested Label Solutions for TIA/EIA-606-A Compliance				
Patch Panel Part Number	Laser/Ink Jet Desktop Printer Label	TDP43ME Thermal Transfer Desktop Printer Label	PanTher™ LS8E Hand-Held Printer Label	Cougar™ LS9 Hand-Held Printer Label
DPOE24U1XG	UILJ6	—	UILS8BW	UILS8BW

For complete Ultimate ID® Labeling Solutions and product information, reference charts on pages O.11 and O.19.

DPoE™ Power Midspan

- Delivers reliable, cost-effective Power over Ethernet to new or existing networks
- Supports up to 32 watts (2X Power) to every port
- Fully compliant with IEEE 802.3af standards
- Compact, modular design allows up to three units to fit horizontally across one rack space

- Dissipates significantly less heat than comparable network equipment
- Scalable to grow network as needed
- Requires 48V DC power supply

**DPOE8S2XG****DPOE8KIT****DPOEWM8B****DPOEPL8BU****DPOESHelf****Component Labels for DPoE™ Power Midspan****Suggested Label Solutions for TIA/EIA-606-A Compliance**

Patch Panel Part Number	Laser/Ink Jet Desktop Printer Label	TDP43ME Thermal Transfer Desktop Printer Label	PanTher™ LS8E Hand-Held Printer Label	Cougar™ LS9 Hand-Held Printer Label
DPOE8S2XG	UILJ4	—	UILS8BW	UILS8BW
DPOEPL8BU	UILJ4	—	UILS8BW	UILS8BW

For complete Ultimate ID® Labeling Solutions and product information, reference charts on pages O.11 and O.19.

DPoE™ Power Supply

- Provides up to 120 watts of regulated power
- Offers flexible placement inside of rack
- Removes AC to DC power conversion heat from power patch panels due to isolation
- LED indicates when power is being supplied to the panel



DPOEPWRB120Y

Part Number	Part Description	Std. Pkg. Qty.
DPOEPWRB120Y	120 watt power supply. Suitable for single unit power installations with low power needs or a mixture of active and passive devices.	1
DPOEPWRB120Y-J	120 watt power supply for use in Japan. Suitable for single unit power installations with low power needs or a mixture of active and passive devices. Kit includes Japan power supply and cord.	1

Power supply requires proper A/C country-specific power cord (CORD-A for Australia, CORD-E for Europe, CORD-S15 for North America, or CORD-U for United Kingdom), must be ordered separately. Japan Power Supply (DPOEPWRB120Y-J) includes CORD-J15 for use in Japan.

DPoE™ Power System

- Offers 48 volt DC power that is scalable from 1,250 watts to 3,750 watts
- Utilizes high efficiency power supplies that can be hot swapped for upgrades or replacement without taking the entire system down
- Provides consistent powering across a wide range of devices and application needs
- Offers a low profile, one rack space design
- Emits 35% less heat compared to other power supply systems
- Increases reliability with problem fault isolation



DPOEPWRCU

Part Number	Part Description	No. of Rack Spaces [^]	Std. Pkg. Qty.
DPOEPWRCU	Power system chassis. Utilized for supplying power to single and multiple power patch panels when equipped with the appropriate DPoE™ Power Rectifiers.	1	1
DPOEPWRR1250	1250 watt power rectifier supplies power for multiple power patch panels. A combination of three rectifiers will support up to fourteen panels. Used with DPOEPWRCU.	—	1

[^]One rack space = 1.75" (44.45mm).

Power system chassis requires proper A/C country-specific power cord, (CORD-A for Australia, CORD-E for Europe, CORD-S15 for United States, CORD-J15 for Japan, or CORD-U for United Kingdom), must be ordered separately.



DPOEPWRR1250

A.
System
Overview



B.
Copper
Systems

C.
Fiber
Optic
Systems

D.
Power
over
Ethernet

E.
Zone
Cabling

F.
Wireless

G.
Outlets

H.
Media
Distribution

I.
Physical
Infrastructure
Management

J.
Overhead &
Underfloor
Routing

K.
Surface
Raceway

L.
Cabinets,
Racks &
Cable
Management

M.
Grounding &
Bonding

N.
Industrial

O.
Labeling &
Identification

P.
Cable
Management
Accessories

Q.
Index

NOTES

PANZONE® ZONE CABLING SYSTEMS

Panduit provides a complete line of zone cabling products for open office architecture applications, telecommunication enclosures, data centers, wireless deployments, and network integration of a Connected Building Solution. Each zone cabling product serves as a main distribution point for a particular zone increasing network flexibility, manageability, accessibility, and efficiency. Utilizing a distributed network and a zone cabling topology for your physical infrastructure can solve telecommunication room congestion. In addition, centralized fiber backbone cables can be integrated into the solution in order to extend the reach of your network beyond copper limitations.





- Consolidation points, MuTOA, zone distribution areas, and telecommunication enclosures can be used to create a zone cabling system that is TIA/EIA-568-B, 569-B, and 942 compliant
- Provide accessibility and flexibility to reconfigure offices to meet frequently changing organizational requirements
- Provide the ability to make moves, adds, and changes quickly and easily
- Reduce network downtime when changes are required
- Can solve telecommunication room congestion
- Provide a low cost alternative for installations that need to be upgraded or reconfigured
- Provide a complete end-to-end network solution that integrates the Panduit wired structured cabling with the Cisco* wireless network equipment

Panduit zone cabling products are completely modular, accepting all Mini-Com® Modules for STP and UTP, fiber optic, and audio/video applications. Zone cabling products accommodate multimedia solutions and can be used in floor, ceiling, and wall mount applications while providing a complete end-to-end network solution. With a zone cabling topology in place, IT managers provide themselves with a scalable physical network infrastructure that meets their needs today as well as the flexibility to deploy the technology of tomorrow.

*Cisco is a registered trademark of Cisco Technology, Inc.

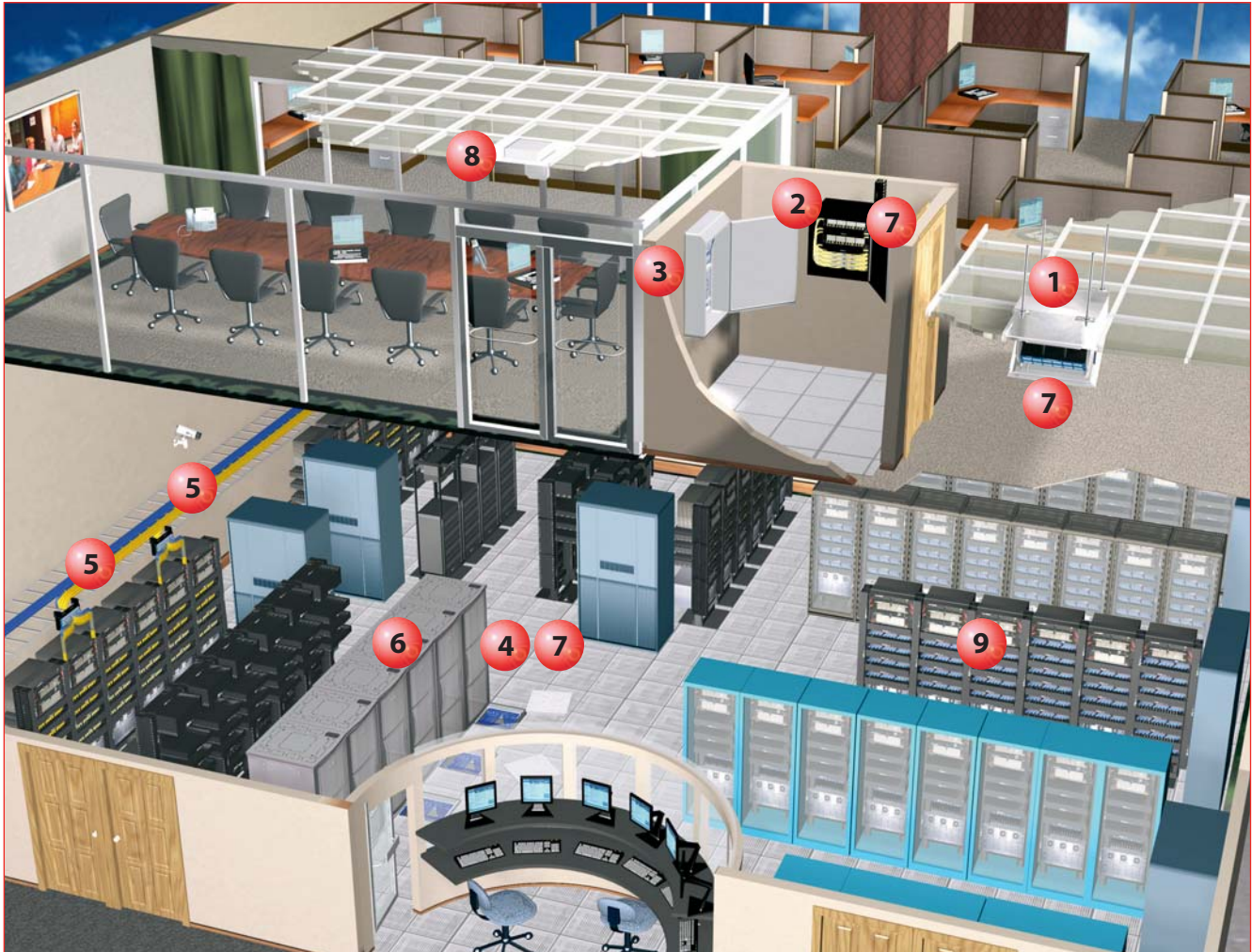
Zone Cabling Systems Roadmap



1 PanZone® In-Ceiling Enclosures (page E.3) 



6 Net-Access® Server Cabinet (pages L.19 – L.22) 



2 PanZone® Wall Mount Cabinet (page E.4) 



7 PanZone® Cable Assemblies (page E.9)



3 PanZone® Building Automation Systems Enclosure (page E.5) 



8 PanZone® Wireless Access Point Enclosures (pages F.4 – F.5) 



4 PanZone® Raised Floor Enclosure (page E.7) 



9 Racks and Cable Management (pages L.59 – L.84)



5 PanZone® Overhead Distribution Racks (page E.6)



PanZone® In-Ceiling Enclosures

- Designed to accept up to 2 RU of active electronics as deep as 17.5" and up to 6 RU of standard 19" passive connectivity (PZICEA only)
- Designed to accept up to 8 RU standard 19" passive connectivity (PZICE only)
- Thermal management design optimizes air flow for improved heat dissipation; ideal for high heat load PoE enabled switch applications
- Mount in 2' x 2', 2' x 4', and 2' x 6' drop ceilings
- 50 pound door weight capacity
- Include door plate, equipment mounting bracket, integrated horizontal cable slack manager
- AC power ready – receptacle not included (PZICEA only)
- Includes low decibel 60 CFM fan (PZICEA only)



PZICEA



PZICE



PZICFK-E

Part Number	Part Description	No. of Rack Spaces [^]	Std. Pkg. Qty.
PanZone® In-Ceiling Enclosures			
PZICEA	Fully assembled in-ceiling active enclosure. Accepts up to 2 RU of active network equipment and up to 6 RU of passive product. Includes mounting brackets, integrated horizontal slack manager, AC power provisions, fan assembly, air dam, and electrical junction box. External dimensions: 13.50"H x 25.50"W x 27.50"D (342.9mm x 647.7mm x 698.5mm). Internal dimensions: 11.49"H x 22.31"W x 22.46"D (291.8mm x 566.7mm x 570.5mm).	5	1
PZICE	Fully assembled in-ceiling enclosure. Accepts up to 8 RU of standard 19" patch panels. Includes mounting brackets and integrated horizontal slack manager. External dimensions: 13.50"H x 25.50"W x 27.50"D (342.9mm x 647.7mm x 698.5mm). Internal dimensions: 11.49"H x 22.31"W x 22.46"D (291.8mm x 566.7mm x 570.5mm).	—	1
PanZone® Accessories			
PZICFK-E	In-ceiling enclosure fan kit power conversion for european regions. Converts fan within in-ceiling active enclosure (PZICEA with 60 CFM fan) to accept 220 VAC/50 Hz power. Includes fan assembly with Shuko plug, air dam, and electrical junction box.	—	1
PZICFRK	Filter replacement kit, includes five pairs of air inlet filters.	—	1
StructuredGround™ Grounding Kit			
PZICGK	Grounding and bonding kit includes all components to properly ground enclosure and two network switches.	—	1

[^]One rack space = 1.75" (44.45mm).



PanZone[®] Wall Mount Cabinets

- Hold 12 RU of active and passive network equipment plus two additional RU for power strips and small electronic devices (modems, routers, etc.)
- Structurally engineered to swing freely even under maximum load capacity
- Thermal management design (vents, perforated doors, and optional fan) optimizes air flow for improved heat dissipation; ideal for high heat load PoE enabled switch applications
- Working load rating of 250 lbs.
- Adjustable rails mount at 1" increments to accommodate various depths of network equipment including PoE switches
- Individual rack spaces are identified for ease of equipment mounting

**PZC12S****PZC12P****PZC12W****PZCHSM2****PZBR4****PZCGK**

Part Number	Part Description	No. of Rack Spaces [^]	Std. Pkg. Qty.
PanZone[®] Wall Mount Cabinets			
PZC12S	Wall mount cabinet with a solid front door; black. Dimensions: 25.81"H x 25.00"W x 22.85"D (655.6mm x 635.0mm x 580.4mm).	12	1
PZC12P	Wall mount cabinet with perforated front door; black. Dimensions: 25.81"H x 25.00"W x 22.85"D (655.6mm x 635.0mm x 580.4mm).	12	1
PZC12W	Wall mount cabinet with windowed front door; black. Dimensions: 25.81"H x 25.00"W x 22.85"D (655.6mm x 635.0mm x 580.4mm).	12	1

PanZone[®] Cable Management Options

PZCHSM2	Wall mount cabinet horizontal slack manager; black. Dimensions: 3.50"H x 19.00"W x 13.00"D (88.9mm x 482.6mm x 330.2mm).	2	2
PZBR3	Cable bend radius post, 3" length.	—	—
PZBR4	Cable bend radius post, 4" length.	—	—

PanZone[®] Accessories

PZCFK	Wall mount cabinet fan kit; kit includes one 115 VAC fan rated at 112 CFM.	—	1
PZCFK-E	Wall mount cabinet fan kit – european version, 220 VAC with Shuko plug.	—	1
PZCFR	Wall mount filter replacement kit.	—	1

StructuredGround[™] Grounding Kit

PZCGK	Grounding and bonding kit; includes all components to properly ground cabinet.	—	1
--------------	--	---	---

[^]One rack space = 1.75" (44.45mm).



PanZone® Active Wall Mount Enclosure

- Holds up to 3 RU of passive product and up to 3 RU of active equipment
- Provides optimal cable management by allowing adequate space to route and manage patch cords
- Patch panel bracket rotates 90° and accepts 19" rack mountable product allowing easy installation
- Provides multiple cable entry/exit points via knockouts
- Design accepts all standard 19" patch panels
- Door can be assembled to hinge on either the right or left side providing flexibility and easy access for any mounting location
- Front cover has standard padlock feature; optional keyed locks available
- Vented design and optional fan provides thermal management for switches and power supplies



PZAEWM3

Part Number	Part Description	No. of Rack Spaces [^]	Std. Pkg. Qty.	Std. Ctn. Qty.
PanZone® Active Wall Mount Enclosure				
PZAEWM3	Active wall mount enclosure includes mounting template for quick installation. Dimensions: 38.50"H x 27.92"W x 8.61"D (977.9mm x 709.2mm x 218.7mm).	6	1	—
PanZone® Air Exchange Fan				
PZAEFAN	Wall mount enclosure fan kit. Kit includes one 115 VAC fan rated at 112 CFM. Enclosure accepts up to two fan kits.	—	1	—
PZAEFK-E	Wall mount enclosure fan kit – european version, 220 VAC with Shuko plug. Fan rated at 112 CFM. Enclosure accepts up to two fan kits.	—	1	—
PanZone® Accessories				
PZAELOCK	Optional keyed lock set; includes two locks with keys.	—	1	10
StructuredGround™ Grounding Kit				
PZAECHK	One tin-plated copper bracket; 3.92"L x .56"W x .79"H (99.6mm x 14.2mm x 20.1mm); provided with four #12-24 screws, one each #10-32 and #10-24 hex nut, #10 split lock washer, grounding washer, and ESD protection sticker.	—	1	—

All product color is gray.
[^]One rack space = 1.75" (44.45mm).



PanZone® Building Automation Systems Enclosure

- Integrates data communications and Building Automation Systems (BAS) by converging the infrastructure into a single ethernet network
- Minimizes installation costs by consolidating BAS equipment into a single enclosure
- Eliminates redundant cable runs
- Provides optimal cable routing and management of patch cords and electrical components
- Vented design and optional fan provides thermal management for network equipment and power supplies



PZBASE3

Part Number	Part Description	No. of Rack Spaces [^]	Color	Std. Pkg. Qty.
PZBASE3	Building automation systems enclosure. Includes perforated panel 32.00"H x 22.50"W (812.8mm x 571.5mm) for mounting BAS devices. Dimensions: 48.50"H x 35.00"W x 8.60"D (1231.9mm x 889.0mm x 218.4mm).	3	White	1
PZBASELK	Optional keyed lock set; includes two locks with keys.	—	—	1

[^]One rack space = 1.75" (44.45mm).
 To bond building automation system enclosure sections, see the StructuredGround™ Enclosure Grounding kit on page M.23.



Consolidation Point Boxes

- Suitable for wall mount and underfloor applications
- UL 2043 approved for use in air-handling spaces for copper applications

- Accept Mini-Com[®] Modules for STP and UTP, fiber optic, and audio/video, which snap in and out for easy moves, adds, and changes
- Supplied with cable management accessories
- Optional fiber conversion kit available

**CUFMB24BL****CUFB48BL**

Part Number	Part Description	Std. Pkg. Qty.	Std. Ctn. Qty.
CUFMB24BL	24-port aluminum underfloor consolidation point box includes pre-printed numbered labels with writable surface on back when pre-numbered labels are not applicable. Dimensions: 1.69"H x 10.85"W x 10.67"L (42.9mm x 275.6mm x 271.0mm).	1	—
CUFB48BL	48-port underfloor consolidation point box made of 16 gauge rugged steel for long term durability. Dimensions: 1.63"H x 10.00"W x 14.88"L (41.4mm x 254.0mm x 378.0mm).	1	—
CUFF-KIT	Optional fiber conversion kit to be used with CUFB48BL and CUFMB24BL. Kit includes: four Panduit [®] Pan-Ty [®] Cable Ties, four wire saddles, two adhesive fiber spools, two support brackets to hold fiber cable, one grounding lug, one laser warning label, one fiber warning label and two rubber grommets.	1	10



PanZone[®] Work Area Raised Floor Consolidation Point Enclosures

- Work with standard office raised floor tiles
- Include Cool Boot[®] Raised Floor Air Sealing Grommet for quick moves, adds, and changes
- Accept all Mini-Com[®] Modules
- Accept field terminated or pre-terminated connectivity solutions
- Secure lockable cover



Part Number	Part Description	Std. Pkg. Qty.
ACE48	Fully assembled office raised floor consolidation point enclosure mounts in 10.5" x 10.5" cutout in one raised floor tile; black finish. Support 48 copper cables or up to 96 fiber cables, accepts Mini-Com [®] Modules. Dimensions: 12.37"H x 12.45"W x 7.88"D (314mm x 316mm x 200mm)	1

PanZone[®] Overhead Distribution Racks

- Ideal solution for adding more rack spaces above racks or cabinets in data centers or telecommunication rooms
- Universal mounting bracket can be mounted to most industry ladder racks, wire basket, or suspended by threaded rod from ceiling
- Multiple mounting configurations
- 40/60/80 lbs. load rating
- Optional cable management solutions (PZBR4 and CMVDR2)

**PZLRB6U**

Part Number	Part Description	Std. Pkg. Qty.
PZLRB2U	2 RU ladder rack bracket. Bracket fits Wyr-Grid [®] Overhead Cable Tray. Dimensions: 8.75"H x 20.26"W x 3.26"D (222.3mm x 514.6mm x 82.8mm)	1
PZLRB4U	4 RU ladder rack bracket. Bracket fits Wyr-Grid [®] Overhead Cable Tray. Dimensions: 12.25"H x 20.26"W x 3.26"D (311.2mm x 514.6mm x 82.8mm)	1
PZLRB6U	6 RU ladder rack bracket. Bracket fits Wyr-Grid [®] Overhead Cable Tray. Dimensions: 15.75"H x 20.26"W x 3.26"D (400.1mm x 514.6mm x 82.8mm)	1

One rack space = 1.75" (44.45mm).



PanZone® Raised Floor Enclosures

- Work with standard office raised floor tiles
- Include Cool Boot® Raised Floor Air Sealing Grommet for quick moves, adds, and changes
- Accept all Mini-Com® Modules
- Accept field terminated or pre-terminated connectivity solutions
- Secure lockable cover
- Compatible with 7/8" square, 1" diameter, 1 1/2" diameter, and 2" diameter raised floor pedestals



PZRFE4U



PZRFE8U



PZRFE12U



PZRFC

Part Number	Part Description	No. of Rack Spaces [^]	Std. Pkg. Qty.
PZRFE4U	Fully assembled raised floor enclosure requires 6" minimum raised floor depth; black finish. Accepts 4 RU of standard patch panels or 2 RU of QuickNet™ Pre-Terminated Assemblies or Cassettes. UL and c-UL Listed. Dimensions: 22.62"H x 22.62"W x 5.0"D (575mm x 575mm x 127mm).	4	1
PZRFE8U	Fully assembled raised floor enclosure requires 9.5" minimum raised floor depth; black finish. Accepts 8 RU of standard patch panels or 4 RU of QuickNet™ Pre-Terminated Assemblies or Cassettes. UL and c-UL Listed. Dimensions: 22.62"H x 22.62"W x 8.5"D (575mm x 575mm x 216mm).	8	1
PZRFE12U	Fully assembled raised floor enclosure requires 13" minimum raised floor depth; black finish. Accepts 12 RU of standard patch panels or 6 RU of QuickNet™ Pre-Terminated Assemblies or Cassettes. UL and c-UL Listed. Dimensions: 22.6"H x 22.6"W x 12.0"D (575mm x 575mm x 305mm).	12	1
PZRFC	Lockable cover for PanZone® Raised Floor Enclosures, includes two keys. Dimensions: 24.0"H x 24.0"W x .75"D (610mm x 610mm x 19.05mm).	—	1

[^]One rack space = 1.75" (44.45mm).



Punchdown Consolidation Point Enclosures

- UL 2043 approved for use in air-handling spaces
- Meet ANSI/TIA-568-C.2 standard
- Mount to wall, above ceiling, and/or below floor



WMCPE



GPB24-X

Part Number	Part Description	Std. Pkg. Qty.
WMCPE	Punchdown consolidation point enclosure. UL2043 approved for use in air handling spaces. Punchdown kit sold separately. Dimensions: 3.44"H x 9.47"W x 13.22"L (87.4mm x 240.5mm x 335.8mm).	1

All product color is black.

Punchdown Bases



GPB144-X



P110B100-X

GPB24-X	Positions and holds UTP wire for termination with Category 6 connecting blocks.	10
GPB144-X	Positions and holds UTP wire for termination with Category 6 punchdown connecting blocks.	10
P110B100-X	Positions and holds UTP cable for termination with Pan-Punch [®] 110 Connecting Blocks. For frame or rack mount wiring behind bases.	10

Image reflects standard density punchdown base.



PanZone[®] Wall Mount Consolidation Point Enclosures

- Can be directly mounted to a wall or recessed into a wall
- Include grommet edging, labels, and Tak-Ty[®] Hook & Loop Cable Ties
- Accommodate up to four 100-pair punchdown bases or optional patch panel bracket (PZBPPB) can be used to accommodate up to 2 RU of standard 19" patch panels
- Conduit knockouts of 1 3/4" – 2" are available on top and bottom; conduit knockouts of 1 1/2" are available on the sides
- Option of flat cover or hinged lockable door (each sold separately)



PZB4



PZB4-HC

Part Number	Part Description	Std. Pkg. Qty.	Std. Ctn. Qty.
PanZone[®] Wall Mount Consolidation Point Enclosure			
PZB4	Enclosure, door not included; select PZB4-HC or PZB4FC. Dimensions: 25.00"H x 14.50"W x 4.65"D (635.0mm x 368.3mm x 118.1mm).	1	—
PZB4-HC	Hinged door to be used with PanZone [®] Enclosure (PZB4) when recessed in a wall. Reversible door can hinge from either side and includes lock with tab release.	1	—
PZB4-FC	Flat cover to be used with PanZone [®] Enclosure (PZB4) when mounting to wall.	1	—



PZB4-FC



PZBPPB

PanZone[®] Enclosure Bracket

PZBPPB	Patch panel bracket accommodates up to 2 RU of standard 19" patch panels. Includes one pair of brackets.	1	10
--------	--	---	----

One rack space = 1.75" (44.45mm).



PanZone® Cable Assemblies

- Exceed ANSI/TIA-568-C.2 and ISO 11801 standards for permanent link performance
- Meet requirements of IEEE 802.3af and IEEE 802.3at for PoE applications
- PanZone® Category 6 and Category 6A Cable Assemblies for use in zone cabling applications
- Available in plug to jack module and plug to plug configurations
- Available in plenum or riser
- T568B wired
- 100% performance tested to permanent link limits



Plug to Plug Shielded Cable Assembly



Jack to Plug UTP Cable Assembly

Part Number	Part Description	Length (Ft.)‡	Cable Type	Cable Color	Std. Pkg. Qty.	Std. Ctn. Qty.
-------------	------------------	---------------	------------	-------------	----------------	----------------

Plug to Plug Cable Assemblies Category 6A Shielded

SAPPBU25	Category 6A, FTP, solid, plenum cable with TX6A™ 10Gig™ Shielded Modular Plugs on each end.	25	FTP Solid Plenum	Blue	1	10
SAPRBU25	Category 6A, FTP, solid, riser cable with TX6A™ 10Gig™ Modular Plugs on each end.	25	FTP Solid Riser	Blue	1	10

Category 6A UTP

UAPPBU25	Category 6A, UTP, solid, plenum cable with TX6A™ 10Gig™ Modular Plugs on each end.	25	UTP Solid Plenum	Blue	1	10
UAPRBU25	Category 6A, UTP, solid, riser cable with TX6A™ 10Gig™ Modular Plugs on each end.	25	UTP Solid Riser	Blue	1	10

Category 6 UTP

UPPBU25Y	Category 6, UTP, solid, plenum cable with TX6™ PLUS Modular Plugs on each end.	25	UTP Solid Plenum	Blue	1	10
UPRBU25Y	Category 6, UTP, solid, riser cable with TX6™ PLUS Modular Plugs on each end.	25	UTP Solid Riser	Blue	—	—

Jack to Plug Cable Assemblies Category 6A Shielded

SAJPBU25BL	Category 6A, FTP, solid, plenum cable with a TX6A™ 10Gig™ Shielded Modular Plug on one end and a black Mini-Com® TX6A™ 10Gig™ Shielded Jack Module on the other.	25	FTP Solid Plenum	Blue	1	10
SAJRBU25BL	Category 6A, FTP, solid, riser cable with a TX6A™ 10Gig™ Shielded Modular Plug on one end and a black Mini-Com® TX6A™ 10Gig™ Shielded Jack Module on the other.	25	FTP Solid Riser	Blue	1	10

Category 6A UTP

UAJPBU25BL	Category 6A, UTP, solid, plenum cable with a TX6A™ 10Gig™ Modular Plug on one end and a black Mini-Com® TX6A™ 10Gig™ Jack Module on the other.	25	UTP Solid Plenum	Blue	1	10
UAJRBU25BL	Category 6A, UTP, solid, riser cable with a TX6A™ 10Gig™ Modular Plug on one end and a black Mini-Com® TX6A™ 10Gig™ Jack Module on the other.	25	UTP Solid Riser	Blue	1	10

Category 6 UTP

UJPBU25BLY	Category 6, UTP, solid, plenum cable with a TX6™ PLUS Modular Plug on one end and a black Mini-Com® TX6™ PLUS Jack Module on the other.	25	UTP Solid Plenum	Blue	1	10
UJRB25BLY	Category 6, UTP, solid, riser cable with a TX6™ PLUS Modular Plug on one end and a black Mini-Com® TX6™ PLUS Jack Module on the other.	25	UTP Solid Riser	Blue	—	10

TX6A™ 10Gig™ Shielded Patch Cords, found on page B.14, can be used as plug to plug cable assemblies.

‡For lengths 10 to 100 feet (five foot increments) and 110, 120, 130, 140, 150 feet change the length designation in the part number to the desired length. For example, the part number for a 100 foot, plug to plug, Category 6A, shielded, riser cable assembly is SAPRBU100.

Cable Labels for PanZone[®] Cable Assemblies

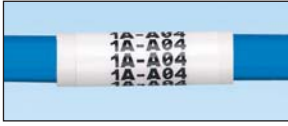

Suggested Label Solutions for TIA/EIA-606-A Compliance

Cable Part Number	Laser/Ink Jet Desktop Printer Label	TDP43ME Thermal Transfer Desktop Printer Label	PanTher™ LS8E Hand-Held Printer Label	Cougar™ LS9 Hand-Held Printer Label
All Pan-Zone [®] Cable Assemblies	S100X150YAJ	S100X150VATY	S100X150VAC	T100X000CBC-BK

For complete labeling solutions and product information, reference charts on pages O.1 – O.22.

WIRELESS SOLUTIONS

Panduit and Cisco Systems have collaborated to develop a complete solution that cost-effectively addresses wireless deployment, security management, and control issues facing enterprises by enabling application interoperability between wired and wireless networks. Panduit physical infrastructure systems complement the Cisco Unified Wireless Network to provide a reliable platform that guards against threats to the wireless local area network (WLAN) and provides protection for critical network elements.



- Ensure full wired and wireless compatibility and interoperability
- Provide integrated solution for lower total cost of ownership
- Cost-effectively address WLAN security, deployment, and management issues
- Aesthetically designed enclosures blend into the enterprise office without compromising wireless performance
- UL rated enclosures are certified for use in plenum spaces

The wireless solution set features Panduit® PanZone® Wireless Access Point Enclosures that accommodate a range of Cisco wireless access points (WAP) capable of being configured in distributed or centralized architectures. These enclosures provide an additional level of security for your WLAN by protecting the access points from tampering, vandalism, theft, and harsh environments. Designed to support a secure and wireless environment, the Panduit cabling infrastructure also includes copper and fiber cabling systems and Power over Ethernet patch panels.

Wireless Solution Roadmap

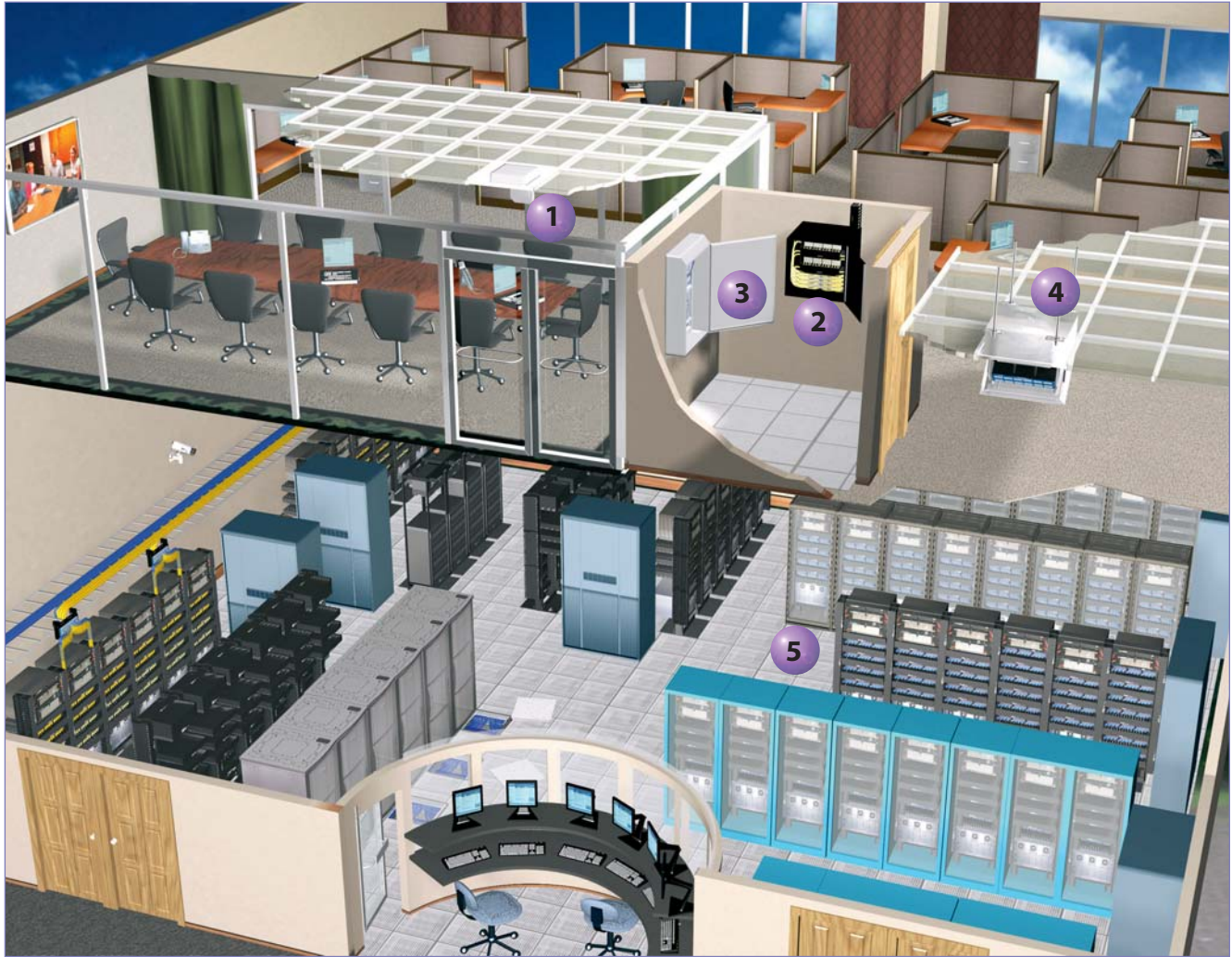

1 Indoor Wireless Access Point Enclosures (Shown) (pages F.3 – F.4) 



4 PanZone[®] In-Ceiling Enclosures (page E.3)



2 PanZone[®] Wall Mount Cabinet (page E.4)



5 Racks and Cable Management (pages L.59 – L.84)



3 PanZone[®] Building Automation Systems Enclosure (page E.5)



PanZone® Wireless Access Point Enclosures

- Specifically designed for use with Cisco^ and other popular Wireless Access Points
- Lockable enclosure protects against tampering, vandalism, and theft
- Knockouts allow multiple antenna configurations
- Integrated ceiling bezel allows unit to replace 2' x 2' ceiling tile
- Optional ceiling bracket kit allows WAP to be mounted in-ceiling for design flexibility for optimum wireless coverage
- 2' x 2' ceiling bracket eliminates cutting the ceiling tile by replacing a standard 2' x 2' ceiling tile



PZWC35E



PZWC35I



PZWC35



PZWIFIENA



PZWIFIED



PZWIFIEA



PZWIFIE

Part Number	Part Description	Color	Std. Pkg. Qty.
Wireless Enclosures Designed for Use with Cisco Aironet^ Series Wireless Access Points			
PZWC35E	PanZone™ Wireless Access Point Enclosure for surface mount or for use in suspended ceilings with optional in-ceiling mounting bracket. Accommodates Cisco Aironet^ 1260 and 3500E Series Wireless Access Points. UL 2043 rated. Dimensions: 13.75"H x 12.0"W x 3.1"D (349.8 mm x 304.8 mm x 78.0mm)	White	1
PZWC35I	PanZone® Wireless Access Point Enclosure; accommodates Cisco Aironet^ 1140 and 3500 Series Wireless Access Points. UL 2043 rated. Dimensions: 23.8"H x 23.8"W x 3.1"D (603mm x 603mm x 78mm).	White	1
PZWC35	PanZone® Wireless Access Point Enclosure for surface mount or for use in suspended ceilings with optional in-ceiling mounting bracket. Accommodates Cisco Aironet^ 1140 and 3500 Series Wireless Access Points. UL 2043 rated. Dimensions: 13.75"H x 12.0"W x 3.1"D	White	1
PZWIFIEN	PanZone® Wireless Access Point Enclosure; accommodates Cisco Aironet^ 1250 Series Wireless Access Points. UL 2043 rated. Dimensions: 13.75"H x 12.00"W x 4.75"D (349.8mm x 304.8mm x 120.6mm).	White	1
PZWIFIENA	PanZone® Wireless Access Point Enclosure; compatible with all Cisco Aironet^ 1250 Series WAPs when used with Cisco Patch Antennas (AIR-ANT5140V-R and/or AIR-ANT2430V-R). UL 2043 rated. Dimensions: 13.75"H x 12.00"W x 4.75"D (349.8mm x 304.8mm x 120.6mm).	White	1
PZWIFIED	PanZone® Wireless Access Point Enclosure; accommodates Cisco Aironet^ 1230 and 1240 Series Wireless Access Points. UL 2043 rated. Dimensions: 13.75"H x 12.00"W x 3.06"D (349.8mm x 304.8mm x 77.7mm).	White	1
PZWIFIEA	PanZone® Wireless Access Point Enclosure; compatible with all Cisco Aironet^ 1200, 1230, and 1240 Series WAPs when used with Cisco Patch Antennas (AIR-ANT5145V-R and/or AIR-ANT5959). UL 2043 rated. Dimensions: 13.75"H x 12.00"W x 3.06"D (349.8mm x 304.8mm x 77.7mm).	White	1
PZWIFIE	PanZone® Wireless Access Point Enclosure; accommodates Cisco Aironet^ 1200 Series Wireless Access Points. UL 2043 rated. Dimensions: 12.00"H x 12.00"W x 2.31"D (304.8mm x 304.8mm x 58.7mm).	White	1

^Cisco, SMARTnet, and Aironet are registered trademarks of Cisco Technology, Inc. For shielded versions of PanZone® Wireless Access Point Enclosures, add suffix "S" to part number.

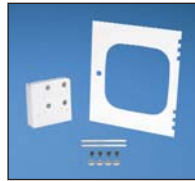
**PanZone[®] Wireless Access Point Enclosures (continued)****PZWIFIEW****PZWRKA****PZWIFIEH****PZWIFIDCB**

Part Number	Part Description	Color	Std. Pkg. Qty.
Wireless Enclosures Designed for Use with Cisco Aironet[^] Series Wireless Access Points (continued)			
PZWIFIEW	PanZone [®] Wireless Access Point Enclosure with windowed front door; accommodates Cisco Aironet [^] 1130 Series Wireless Access Points. Dimensions: 12.00"H x 12.00"W x 2.31"D (304.8mm x 304.8mm x 58.7mm).	White	1
PZWIFIER	PanZone [®] Wireless Access Point Enclosure; accommodates Aruba AP-124 and AP-125 Wireless Access Point. UL 2043 rated. Dimensions: 13.75"H x 12.00"W x 3.06"D (349.8mm X 304.8mm X 77.7mm)	White	1
PZWRKA	PanZone [®] Wireless Access Point Enclosure Retrofit Kit for PZWIFIEA and PZWIFIED enclosures to upgrade to Cisco [^] 1140, 3500 802.11/n access points. Internal Bracket Dimensions: 5.8"H x 5.8"W x 1.7"D (147mm x 147mm x 44mm) Door Dimension: 13.6"H x 11.9"W x .3"D (346mm x 303mm x 8mm)	White	1
Wireless Enclosure Designed for HP, Foundry Networks[‡], Enterasys Networks^{^^}, and Aruba^{^^^} Wireless Access Points			
PZWIFIEH	PanZone [®] Wireless Access Point Enclosure; accommodates HP ProCurve* 420, Foundry [‡] IP200, and Enterasys ^{^^} RBT-4102 Wireless Access Points. UL 2043 rated. Dimensions: 13.75"H X 12.00"W X 3.06"D (349.8mm X 304.8mm X 77.7mm).	White	1
In-Ceiling Mounting Bracket Kits			
PZWIFICB	PanZone [®] Wireless Enclosure In-Ceiling Mounting Bracket Kit for PZWIFIE and PZWIFIEW. Dimensions: 3.31"H x 13.62"W x .75"D (84.1mm x 345.9mm x 19.0mm).	White	1
PZWIFIDCB	PanZone [®] Wireless Enclosure In-Ceiling Mounting Bracket Kit for PZWIFIEN, PZWIFIENA, PZWIFIED, PZWIFIEA and PZWIFIEH. Dimensions: 4.06"H x 13.73"W x .81"D (103.1mm x 348.7mm x 20.6mm).	White	1
PZW2X2CB	PanZone [®] Wireless Enclosure 2x2 ft. In-Ceiling Mounting Bracket Kit for PZWIFIE and PZWIFIEW. Dimensions: 3.19"H x 23.75"W x 23.75"D (81.1mm x 603.3mm x 603.3mm).	White	1
PZW2X2DCB	PanZone [®] Wireless Enclosure 2x2 ft. In-Ceiling Mounting Bracket Kit for PZWIFIEN, PZWIFIENA, PZWIFIED, PZWIFIEA, and PZWIFIEH. Dimensions: 3.94"H x 23.75"W x 23.75"D (100.1mm x 603.3mm x 603.3mm).	White	1

[^]Cisco, SMARTnet, and Aironet are registered trademarks of Cisco Technology, Inc.

*ProCurve is a registered trademark of Hewlett-Packard Development Company, L.P.

[‡]Foundry is a registered trademark of Foundry Networks, Inc.

^{^^}Enterasys is a registered trademark of Enterasys Networks, Inc.

^{^^^}Aruba is a registered trademark of Aruba Networks, Inc.

For shielded versions of PanZone[®] Wireless Access Point Enclosures, add suffix "S" to part number.

PanZone® NEMA 4X/IP66 Rated Wireless Access Point Enclosures

- NEMA 4X and IP66 rating protects against corrosion, windblown dust and rain, splashing water and hose-directed water
- Universal design accommodates the most popular Wireless Access Points including Cisco Aironet[^] 1200, 1230, 1240, 1250, 1300, 1142, and 3500 Series and Aruba^{^^} 92, 105 and 134
- Fiberglass construction and aluminum mounting plate allow quick and easy access point installation
- UL508A Listed and approved
- Include pre-configured mounting template
- Provisions for padlocks to protect against tampering and theft
- Optional NEMA 4X rated fittings available in various sizes
- Optional NEMA 4X drain and vent kit
- Connectivity accessory kit (included): 2-position outlet box, Mini-Com[®] TX6[™] PLUS Jack Module, TX6[™] PLUS Patch Cord, silicone sealant and grounding cable
- Shielded connectivity accessory kit also available



PZNWE12



PZNWE14

Part Number	Part Description	Std. Pkg. Qty.
-------------	------------------	----------------

PanZone® NEMA 4X/IP66 Rated Wireless Access Point Enclosures

PZNWE12	Wireless enclosure designed for Power over Ethernet applications. Includes UTP connectivity kit. External dimensions: 13.56"H x 13.47"W x 6.56"D (344.4mm x 342.1mm x 166.6mm). Internal dimensions: 11.70"H x 11.70"W x 6.29"D (297.2mm x 297.2mm x 159.8mm).	1
PZNWE12S	Wireless enclosure designed for Power over Ethernet applications. Includes shielded connectivity kit. External dimensions: 13.56"H x 13.47"W x 6.56"D (344.4mm x 342.1mm x 166.6mm). Internal dimensions: 11.70"H x 11.70"W x 6.29"D (297.2mm x 297.2mm x 159.8mm).	1
PZNWE14	Wireless enclosure designed for traditional AC power applications. Includes UTP connectivity kit. External dimensions: 15.50"H x 13.50"W x 6.25"D (393.7mm x 342.9mm x 158.8mm). Internal dimensions: 13.53"H x 11.55"W x 5.94"D (343.7mm x 293.4mm x 150.9mm).	1
PZNWE14S	Wireless enclosure designed for traditional AC power applications. Includes shielded connectivity kit. External dimensions: 15.50"H x 13.50"W x 6.25"D (393.7mm x 342.9mm x 158.8mm). Internal dimensions: 13.53"H x 11.55"W x 5.94"D (343.7mm x 293.4mm x 150.9mm).	1

NEMA 4X Rated Fittings and Accessories

PZNF1	NEMA 4X rated compression fitting, ideal for cable diameters of .115" to .250" (2.82mm to 6.35mm).	1
PZNF2	NEMA 4X rated compression fitting, ideal for cable diameters of .230" to .395" (5.84mm to 10.03mm).	1
PZNF3	NEMA 4X rated compression fitting, ideal for cable diameters of .170" to .450" (4.32mm to 11.43).	1
PZNDVK	NEMA 4X drain and vent kit.	1

[^]Cisco and Aironet are registered trademarks of Cisco Systems, Inc.

^{^^}Aruba is a registered trademark of Aruba Networks, Inc.

NOTES

OUTLETS

Panduit offers the most comprehensive selection of communication outlets to extend your copper, audio/video, and fiber cabling system to the work area. From a standard work station configuration to a MuTOA application, Panduit has a solution to support your requirements.

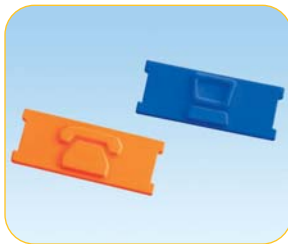

- Completely modular, accepting all Mini-Com® Modules for copper, fiber, and audio/video applications
- Superior design provides lower profile, higher density outlet products, creating a cost-effective solution for easy moves, adds, and changes
- Aesthetically pleasing solution to compliment all types of work areas
- Ultimate ID® components are part of a complete system for identification designed to efficiently support TIA/EIA-606-A standard labeling requirements

Work area outlets products are easily installed and provide a broad range of solutions. Outlets solutions consist of a variety of faceplate styles and port densities, including tamper resistant and water resistant options. Surface mount boxes are available in shuttered and non-shuttered versions.

Workstation Roadmap

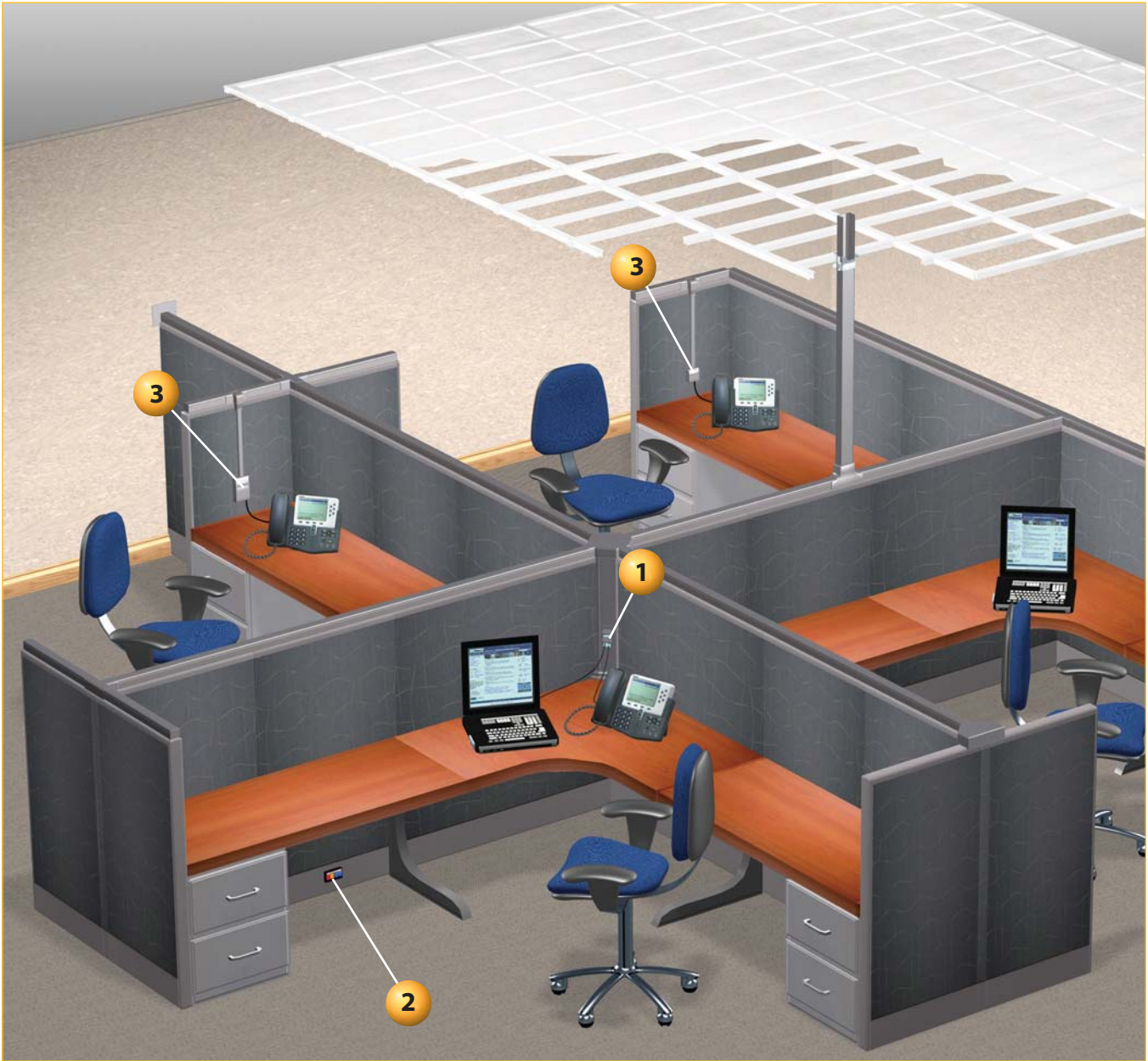

1 Mini-Com® Faceplates
(pages G.3 – G.14)



2 Mini-Com® Modular Furniture Faceplates
(pages G.18 – G.20)



3 Mini-Com® Surface Mount Boxes
(pages G.22 – G.25)





Mini-Com® Ultimate ID® Classic Series Faceplates

- Components are part of a complete system for identification designed to efficiently support TIA/EIA-606-A standard labeling requirements
- Accept Mini-Com® Modules for STP and UTP, fiber optic, and audio/video, which snap in and out for easy moves, adds, and changes
- Supplied with color coordinated screw cover and clear station and port label covers, labels sold separately

- Can be clearly identified with the PanTher™ LS8E or Cougar™ LS9 Hand-Held Thermal Transfer Printers
- Non-adhesive computer printable label sheets for desktop printers and write-on labels available
- Replacement screw covers and label covers available
- Optional icons available



UICFP2IW



UICFP4IW



UICFP6IW



UICFPH2IW



UICFPH4IW

Part Number	Part Description	Color‡	Labels Required*	Std. Pkg. Qty.	Std. Ctn. Qty.
UICFP2IW	Single gang, vertical faceplate holds up to two Mini-Com® Modules.	Off White	One 1-Port One 2-Port	1	10
UICFP4IW	Single gang, vertical faceplate holds up to four Mini-Com® Modules.	Off White	One 1-Port Two 2-Port	1	10
UICFP6IW	Single gang, vertical faceplate holds up to six Mini-Com® Modules. Requires minimum 1.9" wide in-wall box or wallboard adapter for proper installation.	Off White	One 1-Port Two 3-Port	1	10
UICFPH2IW	Single gang, horizontal faceplate holds up to two Mini-Com® Modules.	Off White	One 1-Port One 2-Port	1	10
UICFPH4IW	Single gang, horizontal faceplate holds up to four Mini-Com® Modules.	Off White	One 1-Port One 4-Port	1	10

‡For other colors replace IW (Off White) with EI (Electric Ivory) or WH (White).
All faceplates supplied with mounting screws.

*Ultimate ID® Labels can be found on pages O.11 and O.21.



Mini-Com® Classic Series Faceplates with Label and Label Cover

- Accept Mini-Com® Modules for STP and UTP, fiber optic, and audio/video, which snap in and out for easy moves, adds, and changes

- Include label/label covers for easy port identification
- Replacement label/label covers available



CFPL2IWY



CFPL3IWY



CFPL4IWY



CFPL6IWY

Part Number	Part Description	Color‡	Std. Pkg. Qty.	Std. Ctn. Qty.
CFPL2IWY	Single gang, vertical faceplate accepts two Mini-Com® Modules.	Off White	1	10
CFPL3IWY	Single gang, vertical faceplate accepts three Mini-Com® Modules.	Off White	1	10
CFPL4IWY	Single gang, vertical faceplate accepts four Mini-Com® Modules.	Off White	1	10
CFPL6IWY	Single gang, vertical faceplate accepts six Mini-Com® Modules.	Off White	1	10

‡For other colors replace suffix IW (Off White) with EI (Electric Ivory), WH (White), or IG (International Gray).
All faceplates supplied with mounting screws.

Component Labels for Mini-Com® Classic Series Faceplates with Label and Label Cover



Suggested Label Solutions for TIA/EIA-606-A Compliance

Faceplate Part Number	Laser/Ink Jet Desktop Printer Label	TDP43ME Thermal Transfer Desktop Printer Label	PanTher™ LS8E Hand-Held Printer Label	Cougar™ LS9 Hand-Held Printer Label
All CFPL Parts	C195X040Y1J	C195X040Y1T	C195X040Y1C	T038X000FJC-BK‡

For complete labeling solutions and product information, reference charts on pages O.1 – O.25.

‡For non-adhesive labeling solution, do not remove liner from label.



Mini-Com® Classic Series Sloped Faceplates with Label and Label Cover

- Accept Mini-Com® Modules for STP and UTP, fiber optic, and audio/video, which snap in and out for easy moves, adds, and changes
- Include label/label covers for easy port identification
- Replacement label/label covers available
- Optional icons available



CFPSL2IWY



CFPSL4IWY

Part Number	Part Description	Color‡	Std. Pkg. Qty.	Std. Ctn. Qty.
CFPSL2IWY	Single gang, sloped vertical faceplate accepts two Mini-Com® Modules.	Off White	1	10
CFPSL4IWY	Single gang, sloped vertical faceplate accepts four Mini-Com® Modules.	Off White	1	10
CFPSL6IWY	Single gang, sloped vertical faceplate accepts six Mini-Com® Modules. Requires minimum 1.9" wide electrical box for proper mounting.	Off White	1	10
CFPHSL4IW	Single gang, sloped horizontal faceplate accepts four Mini-Com® Modules.	Off White	1	10

‡For other colors replace suffix IW (Off White) with EI (Electric Ivory), WH (White), or IG (International Gray). All faceplates supplied with mounting screws.



CFPSL6IWY



CFPHSL4IW

Component Labels for Mini-Com® Classic Series Sloped Faceplates with Label and Label Cover



Suggested Label Solutions for TIA/EIA-606-A Compliance

Faceplate Part Number	Laser/Ink Jet Desktop Printer Label	TDP43ME Thermal Transfer Desktop Printer Label	PanTher™ LS8E Hand-Held Printer Label	Cougar™ LS9 Hand-Held Printer Label
All CFPSL Parts	C195X040Y1J	C195X040Y1T	C195X040Y1C	T038X000FJC-BK‡
All CFPHSL4 Parts	C261X035Y1J	C261X035Y1T	C261X035Y1C	T038X000FJC-BK‡

For complete labeling solutions and product information, reference charts on pages O.1 – O.25.

‡For non-adhesive labeling solution, do not remove liner from label.



Mini-Com® Classic Series Faceplates

- Accept Mini-Com® Modules for STP and UTP, fiber optic, and audio/video, which snap in and out for easy moves, adds, and changes
- Optional adhesive labels available



CFP1IW CFP2IW CFP4IW



CFPH2IW CFPH4IW

Part Number	Part Description	Color‡	Std. Pkg. Qty.	Std. Ctn. Qty.
CFP1IW	Single gang, vertical faceplate accepts one Mini-Com® Module.	Off White	1	10
CFP2IW	Single gang, vertical faceplate accepts two Mini-Com® Modules.	Off White	1	10
CFP4IW	Single gang, vertical faceplate accepts four Mini-Com® Modules.	Off White	1	10
CFPH2IW	Single gang, horizontal faceplate accepts two Mini-Com® Modules.	Off White	1	10
CFPH4IW	Single gang, horizontal faceplate accepts four Mini-Com® Modules.	Off White	1	10

‡For other colors replace suffix IW (Off White) with EI (Electric Ivory), WH (White), or IG (International Gray). All faceplates supplied with mounting screws.

Component Labels for Mini-Com® Classic Series Faceplates



Suggested Label Solutions for TIA/EIA-606-A Compliance

Faceplate Part Number	Laser/Ink Jet Desktop Printer Label	TDP43ME Thermal Transfer Desktop Printer Label	PanTher™ LS8E Hand-Held Printer Label	Cougar™ LS9 Hand-Held Printer Label
CFP1	C061X030FJJ	C061X030YPT	C061X030FJC	T031X000FJC-BK
CFP2	C125X030FJJ	C125X030YPT	C125X030FJC	T031X000FJC-BK
CFP4				
CFPH2	C252X030FJJ	C252X030YPT	C252X030FJC	T031X000FJC-BK
CFPH4				

For complete labeling solutions and product information, reference charts on pages O.1 – O.25.



Mini-Com® Classic Series Faceplate Kits

- Accept Mini-Com® Modules for STP and UTP, fiber optic, and audio/video, which snap in and out for easy moves, adds, and changes
- Inserts are front releasable
- Optional adhesive labels available



CFPS4IW CFPF12IW-2G

Part Number	Part Description	Color‡	Std. Pkg. Qty.	Std. Ctn. Qty.
CFPS4IW	Single gang, vertical faceplate frame and two sloped inserts (two module spaces each). Accepts four Mini-Com® Modules.	Off White	1	10
CFPF12IW-2G	Double gang, vertical faceplate frame and six flat inserts (two module spaces each). Accepts twelve Mini-Com® Modules.	Off White	1	10

‡For other colors replace suffix IW (Off White) with EI (Electric Ivory), WH (White), or IG (International Gray). All faceplates supplied with mounting screws.

Component Labels for Mini-Com® Classic Series Faceplate Kits



Suggested Label Solutions for TIA/EIA-606-A Compliance

Faceplate Part Number	Laser/Ink Jet Desktop Printer Label	TDP43ME Thermal Transfer Desktop Printer Label	PanTher™ LS8E Hand-Held Printer Label	Cougar™ LS9 Hand-Held Printer Label
All CFPS4 Parts	C125X030FJJ	C125X030YPT	C125X030FJC	T031X000FJC-BK

For complete labeling solutions and product information, reference charts on pages O.1 – O.25.

UL LISTED Mini-Com® Ultimate ID® Executive Series Faceplates

- Ultimate ID® components are part of a complete system for identification designed to efficiently support TIA/EIA-606-A standard labeling requirements
- Accept Mini-Com® Modules for STP and UTP, fiber optic, and audio/video, which snap in and out for easy moves, adds, and changes
- Raised rail design for aesthetic appeal
- Supplied with color coordinated screw cover and clear station and port label covers, labels sold separately
- Can be clearly identified with the PanTher™ LS8E or Cougar™ LS9 Hand-Held Thermal Transfer Printers
- Non-adhesive computer printable label sheets for desktop printers and write-on labels available
- Replacement screw covers and label covers available
- Optional icons available



UICFPSE2IW



UICFPSE4IW



UICFPSE6IW



UICFPSE8IW-2G



UICFPHSE2IW



UICFPHSE4IW

Part Number	Part Description	Color‡	Labels Required*	Std. Pkg. Qty.	Std. Ctn. Qty.
UICFPSE2IW	Single gang, vertical sloped faceplate holds up to two Mini-Com® Modules.	Off White	One 1-Port One 2-Port	1	10
UICFPSE4IW	Single gang, vertical sloped faceplate holds up to four Mini-Com® Modules.	Off White	One 1-Port Two 2-Port	1	10
UICFPSE6IW	Single gang, vertical sloped faceplate holds up to six Mini-Com® Modules. Requires minimum 1.9" wide in-wall box or wallboard adapter for proper installation.	Off White	One 1-Port Two 3-Port	1	10
UICFPSE8IW-2G	Double gang, vertical faceplate holds up to eight Mini-Com® Modules.	Off White	Four 4-Port	1	10
UICFPHSE2IW	Single gang, horizontal sloped faceplate holds up to two Mini-Com® Modules.	Off White	One 1-Port One 2-Port	1	10
UICFPHSE4IW	Single gang, horizontal sloped faceplate holds up to four Mini-Com® Modules.	Off White	One 1-Port One 4-Port	1	10

‡For other colors replace suffix IW (Off White) with EI (Electric Ivory), WH (White), IG (International Gray), or BL (Black).

All faceplates supplied with mounting screws.

*Ultimate ID® Labels can be found on pages O.11 and O.21.



Mini-Com® Executive Series Faceplates

- Accept Mini-Com® Modules for STP and UTP, fiber optic, and audio/video, which snap in and out for easy moves, adds, and changes
- Include label/label covers for easy port identification
- Raised rail design for aesthetic appeal



CFPE1IWY CFPE2IWY CFPE4IWY

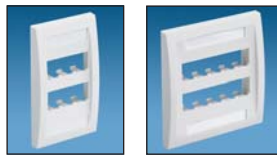

CFPE6IWY CFPE10IW-2GY

Part Number	Part Description	Color‡	Std. Pkg. Qty.	Std. Ctn. Qty.
CFPE1IWY	Single gang, vertical faceplate accepts one Mini-Com® Module.	Off White	1	10
CFPE2IWY	Single gang, vertical faceplate accepts two Mini-Com® Modules.	Off White	1	10
CFPE4IWY	Single gang, vertical faceplate accepts four Mini-Com® Modules.	Off White	1	10
CFPE6IWY	Single gang, vertical faceplate accepts six Mini-Com® Modules. Requires minimum 1.9" wide electrical box for proper mounting.	Off White	1	10
CFPE10IW-2GY	Double gang, vertical faceplate accepts ten Mini-Com® Modules.	Off White	1	10

‡For other colors replace suffix IW (Off White) with EI (Electric Ivory), WH (White), or IG (International Gray). All faceplates supplied with mounting screws.

Component Labels for Mini-Com™ Executive Series Faceplates



Suggested Label Solutions for TIA/EIA-606-A Compliance

Faceplate Part Number	Laser/Ink Jet Desktop Printer Label	TDP43ME Thermal Transfer Desktop Printer Label	PanTher™ LS8E Hand-Held Printer Label	Cougar™ LS9 Hand-Held Printer Label
CFPE1**Y	C195X040Y1J	C195X040Y1T	C195X040Y1C	T038X000FJC-BK‡
CFPE2**Y				
CFPE4**Y				
CFPE6**Y				
CFPE10**-2GY	C288X040Y1J	C288X040Y1T	C288X040Y1C	T038X000FJC-BK‡

For complete labeling solutions and product information, reference charts on pages O.1 – O.25.

‡For non-adhesive labeling solution, do not remove liner from label.



Mini-Com® Sloped Executive Series Faceplate Kit

- Accepts Mini-Com® Modules for STP and UTP, fiber optic, and audio/video, which snap in and out for easy moves, adds, and changes
- Sloped inserts are front releasable
- Includes label/label covers for easy port identification
- Raised rail design for aesthetic appeal



Part Number	Part Description	Color‡	Std. Pkg. Qty.	Std. Ctn. Qty.
CFPSE4IWY	Single gang, vertical faceplate frame and two sloped inserts (two module spaces each). Accepts four Mini-Com® Modules.	Off White	1	10

‡For other colors replace suffix IW (Off White) with EI (Electric Ivory), WH (White), or IG (International Gray). All faceplates supplied with mounting screws.

Component Labels for Mini-Com[®] Sloped Executive Series Faceplate Kits

Suggested Label Solutions for TIA/EIA-606-A Compliance				
Faceplate Part Number	Laser/Ink Jet Desktop Printer Label	TDP43ME Thermal Transfer Desktop Printer Label	PanTher™ LS8E Hand-Held Printer Label	Cougar™ LS9 Hand-Held Printer Label
CFPSE4**Y	C195X040Y1J	C195X040Y1T	C195X040Y1C	T038X000FJC-BK‡

For complete labeling solutions and product information, reference charts on pages O.1 – O.25.

‡For non-adhesive labeling solution, do not remove liner from label.

Mini-Com[®] Executive Series Faceplate Kits with Jack Modules

- Accept Mini-Com[®] Category 6 (CJ688TG), Category 5e (CJ5E88TG), or Category 3 (CJ66U) Modules, which snap in and out for easy moves, adds, and changes
- Convenience of having a faceplate with all the components to complete the outlet, in one package



CFKE2



CFKE4

Part Number	Part Description	Color‡	Std. Pkg. Qty.	Std. Ctn. Qty.
Two Module Space Single Gang Faceplate Kit				
CFKE2A5U5J	Includes 2-port executive faceplate with two Mini-Com [®] Category 5e Jack Modules (BU, OR).	Off White	1	10
CFKE2A6U6J	Includes 2-port executive faceplate with two Mini-Com [®] Category 6 Jack Modules (BU, OR).	Off White	1	10
CFKE2A5U3A	Includes 2-port executive faceplate with one Mini-Com [®] Category 5e Jack Module (BU) and one Mini-Com [®] Category 3 Jack Module (IW).	Off White	1	10
CFKE2A6U3A	Includes 2-port executive faceplate with one Mini-Com [®] Category 6 Jack Module (BU) and one Mini-Com [®] Category 3 Jack Module (IW).	Off White	1	10
CFKE2F5U5J	Includes 2-port executive faceplate with two Mini-Com [®] Category 5e Jack Modules (BU, OR).	Electric Ivory	1	10
CFKE2F6U6J	Includes 2-port executive faceplate with two Mini-Com [®] Category 6 Jack Modules (BU, OR).	Electric Ivory	1	10
CFKE2F5U3F	Includes 2-port executive faceplate with one Mini-Com [®] Category 5e Jack Module (BU) and one Mini-Com [®] Category 3 Jack Module (EI).	Electric Ivory	1	10
CFKE2F6U3F	Includes 2-port executive faceplate with one Mini-Com [®] Category 6 Jack Module (BU) and one Mini-Com [®] Category 3 Jack Module (EI).	Electric Ivory	1	10
Four Module Space Single Gang Faceplate Kit with Blanks				
CFKE4A5U5J3AMA	Includes 4-port executive faceplate with two Mini-Com [®] Category 5e Jack Modules (BU, OR), one Mini-Com [®] Category 3 Jack Module (IW), and a blank.	Off White	1	10
CFKE4A6U6J5AMA	Includes 4-port executive faceplate with two Mini-Com [®] Category 6 Jack Modules (BU, OR), one Mini-Com [®] Category 5e Jack Module (IW), and a blank.	Off White	1	10
CFKE4F5U5J3FMF	Includes 4-port executive faceplate with two Mini-Com [®] Category 5e Jack Modules (BU, OR), one Mini-Com [®] Category 3 Jack Module (EI), and a blank.	Electric Ivory	1	10
CFKE4F6U6J5FMF	Includes 4-port executive faceplate with two Mini-Com [®] Category 6 Jack Modules (BU, OR), one Mini-Com [®] Category 5e Jack Module (EI), and a blank.	Electric Ivory	1	10

‡Faceplate colors IW (Off White) or EI (Electric Ivory).

Jack module colors BU (Blue), OR (Orange), IW (Off White), EI (Electric Ivory).

Blank matches color of faceplate.

Component Labels for Mini-Com® Executive Series Faceplate Kits with Jack Modules



Suggested Label Solutions for TIA/EIA-606-A Compliance

Faceplate Part Number	Laser/Inkjet Desktop Printer Label	TDP43ME Thermal Transfer Desktop Printer Label	PanTher™ LS8E Hand-Held Printer Label	Cougar™ LS9 Hand Held Printer Label
CFKE2*	C195X040Y1J	C195X040Y1T	C195X040Y1C	T038X000FJC-BK‡
CFKE4*				

For complete labeling solutions and product information, reference charts on pages O.1 – O.25.

‡For non-adhesive labeling solution, do not remove liner from label.



Mini-Com® Ultimate ID® Tamper Resistant Faceplate Kit

- Ultimate ID® components are part of a complete system for identification designed to efficiently support TIA/EIA-606-A standard labeling requirements
- Includes tamper resistant screw to prevent unauthorized access to the connections
- Front accessible inserts are recessed and provide a 30° slope to provide proper bend radius control
- Requires minimum in-wall box depth of 2.125"
- Accepts Mini-Com® Modules for STP and UTP, fiber optic, and audio/video, which snap in and out for easy moves, adds, and changes

- Supplied with color coordinated screw cover
- Can be clearly identified with the PanTher™ LS8E or Cougar™ LS9 Hand-Held Thermal Transfer Printers
- Non-adhesive computer printable label sheets for desktop printers and write-on labels available
- Replacement screw covers and label covers available
- Optional icons available



Part Number	Part Description	Color‡	Labels Required*	Std. Pkg. Qty.	Std. Ctn. Qty.
UICFPTR4IW	Tamper resistant faceplate kit includes faceplate frame, two recessed modular inserts, faceplate cover with additional outlet station identifier and tamper resistant screw. Holds up to four Mini-Com® Modules.	Off White	One 1-Port Two 2-Port	1	10

‡For other colors replace suffix IW (Off White) with EI (Electric Ivory) or WH (White).

All faceplates supplied with mounting screws.

T8 Torx driver required for installation of tamper resistant screw.

*Ultimate ID® Labels can be found on pages O.11 and O.21.



Mini-Com® Tamper Resistant Faceplates

- Include two tamper resistant screws to prevent unauthorized access to the connections (combo head screws also included)
- Sloped design improves bend radius control
- Made of impact resistant material
- Optional icons available

- Two-piece hinged design
- Mount to single gang opening
- Accept Mini-Com® Modules for STP and UTP, fiber optic, and audio/video, which snap in and out for easy moves, adds, and changes



CFPTR4IW



CFPTR2BEI

Part Number	Part Description	Color‡	Std. Pkg. Qty.	Std. Ctn. Qty.
CFPTR4IW	Single gang, vertical tamper resistant faceplate accepts four Mini-Com® Modules. Dimensions 5.8"H x 3.1"W x 1.5"D (147.32mm x 78.74mm x 38.10mm).	Off White	1	10
CFPTR2BEI	Single gang, vertical tamper resistant faceplate with two encased sloped ports and two accessible breakout ports in the base; accepts up to four Mini-Com® Modules. Dimensions 5.8"H x 3.1"W x 1.5"D (147.32mm x 78.74mm x 38.10mm).	Electric Ivory	1	10

‡For other colors replace suffix IW (Off White) with EI (Electric Ivory), WH (White), IG (International Gray), BL (Black), CIG (International Gray base with Clear cover), or CL (Clear base and cover).
All faceplates supplied with mounting screws.
Fiber modules are not recommended for use in bottom two module spaces due to bend radius control requirements.

Component Labels for Mini-Com® Tamper Resistant Faceplates



Suggested Label Solutions for TIA/EIA-606-A Compliance				
Faceplate Part Number	Laser/Ink Jet Desktop Printer Label	TDP43ME Thermal Transfer Desktop Printer Label	PanTher™ LS8E Hand-Held Printer Label	Cougar™ LS9 Hand-Held Printer Label
All CFPTR Parts	C125X030FJJ	C125X030YPT	C125X030FJC	T031X000FJC-BK

For complete labeling solutions and product information, reference charts on pages O.1 – O.25.



Mini-Com® Water Resistant Faceplate

- Includes unique gaskets that prevent water from entering and damaging connections
- Meets the level of protection required for an IP56 enclosure
- Sloped design improves bend radius control
- Made of impact resistant material
- Optional icons available
- Two-piece hinged design
- Mounts to single gang opening
- Includes combo head screws to secure cover to base (tamper resistant screws also included)
- Accepts Mini-Com® Modules for STP and UTP, fiber optic, and audio/video, which snap in and out for easy moves, adds, and changes



Part Number	Part Description	Color‡	Std. Pkg. Qty.	Std. Ctn. Qty.
CFPWR4CIG	Single gang, vertical water resistant faceplate accepts four Mini-Com® Modules. Dimensions 5.8"H x 3.1"W x 1.5"D (147.32mm x 78.74mm x 38.10mm).	International Gray Base and Clear Cover	1	10

‡For other colors replace suffix CIG (International Gray base with Clear cover) with CL (Clear base and cover), IG (International Gray), IW (Off White), BL (Black), EI (Electric Ivory), or WH (White). All faceplates supplied with mounting screws. Fiber modules are not recommended for use in bottom two module spaces due to bend radius control requirements.

Component Labels for Mini-Com® Water Resistant Faceplate



Suggested Label Solutions for TIA/EIA-606-A Compliance				
Faceplate Part Number	Laser/Ink Jet Desktop Printer Label	TDP43ME Thermal Transfer Desktop Printer Label	PanTher™ LS8E Hand-Held Printer Label	Cougar™ LS9 Hand-Held Printer Label
CFPWR4CIG	C125X030FJJ	C125X030YPT	C125X030FJC	T031X000FJC-BK

For complete labeling solutions and product information, reference charts on pages O.1 – O.25.

Mini-Com® Ultimate ID® Stainless Steel Faceplates

- Ultimate ID® components are part of a complete system for identification designed to efficiently support TIA/EIA-606-A standard labeling requirements
- Accept Mini-Com® Modules for STP and UTP, fiber optic, and audio/video, which snap in and out for easy moves, adds, and changes
- Supplied with coordinated screw cover and clear station and port label covers, labels sold separately
- Impact-resistant 304 stainless steel suitable for light industrial environments



UICFP2S



UICFP4S



UICFP6S

Part Number	Part Description	Labels Required*	Std. Pkg. Qty.	Std. Ctn. Qty.
UICFP2S	Single gang, vertical faceplate holds up to two Mini-Com® Modules.	One 1-Port One 2-Port	1	10
UICFP4S	Single gang, vertical faceplate holds up to four Mini-Com® Modules.	One 1-Port Two 2-Port	1	10
UICFP6S	Single gang, vertical faceplate holds up to six Mini-Com® Modules. Requires minimum 1.9" wide in wall box or wallboard adapter for proper installation.	One 1-Port Two 3-Port	1	10

All faceplates supplied with mounting screws.

*Ultimate ID® Labels can be found on pages O.11 and O.21.



Mini-Com® Stainless Steel Faceplates with Labels

- Accept Mini-Com® Modules for STP and UTP, fiber optic, and audio/video, which snap in and out for easy moves, adds, and changes
- Include label/label covers for easy port identification
- Replacement label/label covers available on page G.29
- Impact-resistant 304 stainless steel suitable for light industrial environments



CFPL2SY



CFPL4SY



CFPL6SY



CFPL4S-2GY



CFPL6S-2GY



CFPL8S-2GY



CFPL10S-2GY

Part Number	Part Description	Std. Pkg. Qty.	Std. Ctn. Qty.
CFPL2SY	Single gang, vertical faceplate accepts two Mini-Com® Modules.	1	10
CFPL4SY	Single gang, vertical faceplate accepts four Mini-Com® Modules. Requires minimum 1.9" wide electrical box for proper mounting.	1	10
CFPL6SY	Single gang, vertical faceplate accepts six Mini-Com® Modules. Requires minimum 1.9" wide electrical box for proper mounting.	1	10
CFPL4S-2GY	Double gang, vertical faceplate accepts four Mini-Com® Modules.	1	10
CFPL6S-2GY	Double gang, vertical faceplate accepts six Mini-Com® Modules.	1	10
CFPL8S-2GY	Double gang, vertical faceplate accepts eight Mini-Com® Modules.	1	10
CFPL10S-2GY	Double gang, vertical faceplate accepts ten Mini-Com® Modules.	1	10

All faceplates include mounting screws.

Component Labels for Mini-Com® Stainless Steel Faceplates with Labels



Suggested Label Solutions for TIA/EIA-606-A Compliance

Faceplate Part Number	Laser/Ink Jet Desktop Printer Label	TDP43ME Thermal Transfer Desktop Printer Label	PanTher™ LS8E Hand-Held Printer Label	Cougar™ LS9 Hand-Held Printer Label
CFPL2SY	C195X040Y1J	C195X040Y1T	C195X040Y1C	T038X000FJC-BK‡
CFPL4SY				
CFPL6SY				
CFPL4S-2GY	C288X040Y1J	C288X040Y1T	C288X040Y1C	T038X000FJC-BK‡
CFPL6S-2GY				
CFPL8S-2GY				
CFPL10S-2GY				

For complete labeling solutions and product information, reference charts on pages O.1 – O.25.

‡For non-adhesive labeling solution, do not remove liner from label.



Mini-Com® Stainless Steel Faceplates

- Accept Mini-Com® Modules for STP and UTP, fiber optic, and audio/video, which snap in and out for easy moves, adds, and changes
- Impact-resistant 304 stainless steel suitable for light industrial environments
- Optional adhesive labels available



CFP2SY



CFP4SY



CFP6SY



CFP4S-2GY



CFP8S-2GY



CFP10S-2GY

Part Number	Part Description	Std. Pkg. Qty.	Std. Ctn. Qty.
CFP2SY	Single gang, vertical faceplate accepts two Mini-Com® Modules.	1	10
CFP4SY	Single gang, vertical faceplate accepts four Mini-Com® Modules. Requires minimum 1.9" wide electrical box for proper mounting.	1	10
CFP6SY	Single gang, vertical faceplate accepts six Mini-Com® Modules. Requires minimum 1.9" wide electrical box for proper mounting.	1	10
CFP4S-2GY	Double gang, vertical faceplate accepts four Mini-Com® Modules.	1	10
CFP8S-2GY	Double gang, vertical faceplate accepts eight Mini-Com® Modules.	1	10
CFP10S-2GY	Double gang, vertical faceplate accepts ten Mini-Com® Modules.	1	10

All faceplates include mounting screws.

Component Labels for Mini-Com® Stainless Steel Faceplates



Suggested Label Solutions for TIA/EIA-606-A Compliance				
Faceplate Part Number	Laser/Ink Jet Desktop Printer Label	TDP43ME Thermal Transfer Desktop Printer Label	PanTher™ LS8E Hand-Held Printer Label	Cougar™ LS9 Hand-Held Printer Label
CFP2SY	C061X030FJJ	C061X030YPT	C061X030FJC	T031X000FJC-BK
CFP4SY				
CFP4S-2GY				
CFP6SY	C188X030FJJ	C188X030YPT	C188X030FJC	T031X000FJC-BK
CFP8S-2GY	C125X030FJJ	C125X030YPT	C125X030FJC	T031X000FJC-BK
CFP10S-2GY	C315X030FJJ	C315X030YPT	C315X030FJC	T031X000FJC-BK

For complete labeling solutions and product information, reference charts on pages O.1 – O.25.



Mini-Com® Classic and Executive Faceplate Frames

- Accept inserts which snap in and out of faceplate frames
- All inserts are front releasable
- Allow custom installations with your choice of inserts
- Optional adhesive labels available
- Executive faceplates frames have raised rail design for aesthetic appeal



CBIW



CBIW-2G



CBEIYW



CBEIYW-2GY

Part Number	Part Description	Color‡	Std. Pkg. Qty.	Std. Ctn. Qty.
Classic Faceplate Frames				
CBIW	Single gang faceplate frame accepts two 1/2 size module inserts or three 1/3 size module inserts.	Off White	1	10
CBIW-2G	Double gang faceplate frame accepts up to four 1/2 size module inserts or six 1/3 size module inserts.	Off White	1	10
Executive Faceplate Frames				
CBEIYW	Single gang faceplate frame accepts up to two 1/2 size module inserts or three 1/3 size module inserts. Supplied with labels and label cover/screw covers.	Off White	1	10
CBEIYW-2GY	Double gang faceplate frame accepts up to four 1/2 size module inserts or six 1/3 size module inserts. Supplied with labels and label cover/screw covers.	Off White	1	10

‡For other colors replace suffix IW (Off White) with EI (Electric Ivory), WH (White), IG (International Gray), or BL (Black).

All faceplate frames supplied with mounting screws.

Component Labels for Mini-Com® Classic and Executive Faceplate Frames



Suggested Label Solutions for TIA/EIA-606-A Compliance

Frame Part Number	Laser/Ink Jet Desktop Printer Label	TDP43ME Thermal Transfer Desktop Printer Label	PanTher™ LS8E Hand-Held Printer Label	Cougar™ LS9 Hand-Held Printer Label
CBE**Y	C195X040Y1J	C195X040Y1T	C195X040Y1C	T038X000FJC-BK‡
CBE**-2GY	C288X040Y1J	C288X040Y1T	C288X040Y1C	T038X000FJC-BK‡

For complete labeling solutions and product information, reference charts on pages O.1 – O.25.

‡For non-adhesive labeling solution, do not remove liner from label.



Mini-Com® Inserts

- Compatible with classic and executive faceplate frames
- Front releasable
- Accept Mini-Com® Modules for STP and UTP, fiber optic, and audio/video, which snap in and out for easy moves, adds, and changes



CHS2IW-X



CHS2SIW-X



CHF2IW-X

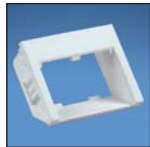

CHSRE2IW-X



CHS1SIW-X



CHB2IW-X

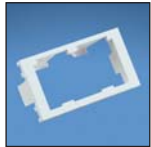

CHF2MIW-X



CHB2MIW-X



CHLS2SIW-X

Part Number	Part Description	Color‡	Std. Pkg. Qty.	Std. Ctn. Qty.
CHS2IW-X	Two module space, 1/2 size, sloped insert accepts two Mini-Com® Modules.	Off White	10	50
CHS2SIW-X	Two module space, 1/2 size, sloped shuttered insert accepts two Mini-Com® Modules. Shutters are spring loaded and rotate out of the way for cable connections. Not suitable for use with any audio/video or fiber connector module that protrudes beyond the face of the insert.	Off White	10	50
CHF2IW-X	Two module space, 1/2 size, flat insert accepts two Mini-Com® Modules.	Off White	10	50
CHSRE2IW-X	Two module space, 1/2 size, 30° sloped recessed insert accepts two Mini-Com® Modules.	Off White	10	50
CHS1SIW-X	One module space, 1/2 size, sloped shuttered insert accepts one Mini-Com® Module. Not suitable for use with any audio/video or fiber connector module that protrudes beyond the face of the insert.	Off White	10	50
CHB2IW-X	1/2 blank insert. Reserves space for future upgrades.	Off White	10	50
CHF2MIW-X	Two module space, 1/3 size, flat insert accepts two Mini-Com® Modules.	Off White	10	50
CHB2MIW-X	1/3 blank insert. Reserves space for future upgrades.	Off White	10	50
CHLS2SIW-X	Sloped module insert with protective shutters and label/label cover accepts up to two Mini-Com® Modules and accommodates up to 1/2 of a single gang bezel. Shutters are spring loaded and rotate out of the way for cable connections. Depth to rear modules: 16.5mm. Not suitable for use with any audio/video or fiber connector module that protrudes beyond the face of the insert.	Off White	10	50

‡For other colors replace suffix IW (Off White) with EI (Electric Ivory), WH (White), IG (International Gray), or BL (Black).

Component Labels for Mini-Com® Inserts



Suggested Label Solutions for TIA/EIA-606-A Compliance				
Insert Part Number	Laser/Ink Jet Desktop Printer Label	TDP43ME Thermal Transfer Desktop Printer Label	PanTher™ LS8E Hand-Held Printer Label	Cougar™ LS9 Hand-Held Printer Label
CHS2	C125X030FJJ	C125X030YPT	C125X030FJC	T031X000FJC-BK
CHS2S				
CHSRE2				
CHS1S	C061X030FJJ	C061X030YPT	C061X030FJC	T031X000FJC-BK
CHF2	C125X030FJJ	C125X030YPT	C125X030FJC	T031X000FJC-BK

For complete labeling solutions and product information, reference charts on pages O.1 – O.25.



Mini-Com® In-Wall Fiber Spool

- Maintains 1" internal bend radius
- Cable entry/exit from rear, top, and bottom helps maintain external bend radius
- Designed for use with single or double gang wall board adapter
- Stores up to 12 meters of unjacketed fiber cable or two meters of jacketed fiber cable
- 3.65" (92.7mm) depth from rear of faceplate, not for use with in-wall boxes or in shallow walls



Part Number	Part Description	Color‡	Std. Pkg. Qty.	Std. Ctn. Qty.
CFS2IW	In-wall fiber spool for use with Mini-Com® Faceplates, Faceplate Frames, Inserts and Modular Patch Panels.	Off White	1	10

‡For other colors replace suffix IW (Off White) with EI (Electric Ivory), WH (White), IG (International Gray), or BL (Black).

Standards: TIA/EIA-568-B requires a minimum 1 meter slack and a fiber spool for in-wall installations.



Mini-Com® “GFCI” Decora Module Frames

- Mount behind any standard GFCI electrical faceplate
- Accept Mini-Com® Modules for STP and UTP, fiber optic, and audio/video, which snap in and out for easy moves, adds, and changes
- Optional adhesive labels available



CFG1IW



CFG2IW

Part Number	Part Description	Color‡	Std. Pkg. Qty.	Std. Ctn. Qty.
CFG1IW	Module frame accepts one Mini-Com® Module.	Off White	1	10
CFG2IW	Module frame accepts two Mini-Com® Modules.	Off White	1	10
CFG4IW	Module frame accepts four Mini-Com® Modules.	Off White	1	10
CFG6IW	Module frame accepts six Mini-Com® Modules.	Off White	1	10

‡For other colors replace suffix IW (Off White) with EI (Electric Ivory), WH (White), IG (International Gray), or BL (Black).

All frames include mounting screws.



CFG4IW



CFG6IW

Component Labels for Mini-Com® “GFCI” Decora Module Frames



Suggested Label Solutions for TIA/EIA-606-A Compliance

Frame Part Number	Laser/Ink Jet Desktop Printer Label	TDP43ME Thermal Transfer Desktop Printer Label	PanTher™ LS8E Hand-Held Printer Label	Cougar™ LS9 Hand-Held Printer Label
CFG1	C061X030FJJ	C061X030YPT	C061X030FJC	T031X000FJC-BK
CFG2				
CFG4	C125X030FJJ	C125X030YPT	C125X030FJC	T031X000FJC-BK

For complete labeling solutions and product information, reference charts on pages O.1 – O.25.



Mini-Com® 106 Duplex Module Frames

- Mount behind standard 106 NEMA faceplates
- Accept Mini-Com® Modules for STP and UTP, fiber optic, and audio/video, which snap in and out for easy moves, adds, and changes

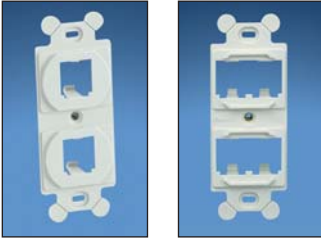

CF1062IWY

CF1064IWY

Part Number	Part Description	Color‡	Std. Pkg. Qty.	Std. Ctn. Qty.
CF1062IWY	Module frame accepts two Mini-Com® Modules.	Off White	1	10
CF1064IWY	Module frame accepts four Mini-Com® Modules.	Off White	1	10

‡For other colors replace suffix IW (Off White) with EI (Electric Ivory), WH (White), IG (International Gray), or BL (Black).
All frames supplied with mounting screws.



Phone Plate with Module

- Stainless steel construction
- Includes mounting studs on plate which are positioned to mount standard wall mount telephones with keystone adaptation flush to wall surface



Part Number	Part Description	Std. Pkg. Qty.	Std. Ctn. Qty.
KWP5EY	Stainless steel phone plate with Giga-TX™ Style Category 5e Keystone Jack Module.	1	10
KWP6PY	Stainless steel phone plate with Giga-TX™ Style Category 6 Keystone Jack Module.	1	10

Contact technical support to verify mounting holes when using IP or console type telephones.
All faceplates supplied with mounting screws.
Wall mount faceplate kits above only accept wall mountable phones with short patch cord connections to the jack module.

Component Labels for Keystone Phone Plate with Module



Suggested Label Solutions for TIA/EIA-606-A Compliance

Phone Plate Part Number	Laser/Ink Jet Desktop Printer Label	TDP43ME Thermal Transfer Desktop Printer Label	PanTher™ LS8E Hand-Held Printer Label	Cougar™ LS9 Hand-Held Printer Label
All KWP parts	C061X030FJJ	C061X030YPT	C061X030FJC	T031X000FJC-BK

For complete labeling solutions and product information, reference charts on pages O.1 – O.25.



Wall Board Adapters

- Provide a mounting surface for single or double gang faceplates

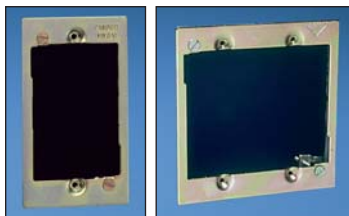

MWBA1

MWBA-2G

Part Number	Part Description	Std. Pkg. Qty.	Std. Ctn. Qty.
MWBA1	An alternative for single gang in-wall box in communication applications. Mounting hole spacing of 3.28" (83.5mm).	1	10
MWBA-2G	An alternative for double gang in-wall boxes in communication applications. Mounting hole spacing of 3.28" (83.5mm).	1	10

Adapters supplied with mounting screws.
Can be used with Low Voltage Mounting Brackets, page G.29.

UL LISTED SP In-Wall Box Adapters

- Allow horizontal or vertical mounting



Part Number	Part Description	Color‡	Std. Pkg. Qty.	Std. Ctn. Qty.
MIWBAIW	Allows mounting of Mini-Com® Single Gang Faceplates and Surface Mount Boxes to double gang in-wall boxes and box eliminators.	Off White	1	10

‡For other colors replace suffix IW (Off White) with EI (Electric Ivory), WH (White), or IG (International Gray). Adapters supplied with mounting screws.

UL LISTED SP Tombstone Floor Box Adapter Plate

- Allows Mini-Com® Snap-On Modular Furniture Faceplates to be mounted to Walker* floor box
- Faceplate opening accepts Panduit CFFPL4, CFFP4, and CFFPE3 snap-on modular furniture faceplates



Part Number	Part Description	Std. Pkg. Qty.	Std. Ctn. Qty.
MSP500W	Stainless steel adapter plate mounts to Walker* floor box service fitting (Walker* part no. 525).	1	10

*Walker is a trademark of The Wiremold Co.

UL LISTED SP Mini-Com® Ultimate ID® Modular Furniture Faceplate

- Ultimate ID® components are part of a complete system for identification designed to efficiently support TIA/EIA-606-A standard labeling requirements
- Accepts Mini-Com® Modules for STP and UTP, fiber optic, and audio/video, which snap in and out for easy moves, adds, and changes
- Supplied with clear station and port label covers, labels sold separately
- Can be clearly identified with the PanTher™ LS8E or Cougar™ LS9 Hand-Held Thermal Transfer Printers
- Computer printable label sheets for desktop printers and write-on labels available
- Replacement label covers available
- Optional icons available
- Fits standard furniture openings



Part Number	Part Description	Color‡	Labels Required*	Std. Pkg. Qty.	Std. Ctn. Qty.
UICFFP4BL	Faceplate snaps into standard knockouts found on modular furniture. Holds up to four Mini-Com® Modules. See panel cutout requirement.	Black	One 1-Port One 4-Port	1	10

‡For other colors replace suffix BL (Black) with EI (Electric Ivory), IG (International Gray), or IW (Off White).
*Ultimate ID® Labels can be found on pages O.11 and O.19.

Panel Cutout Requirement:

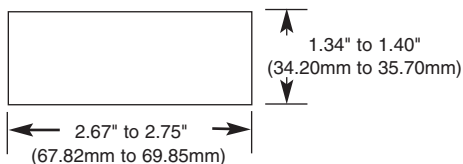



Mini-Com® Snap-On Modular Furniture Faceplates

- Accept Mini-Com® Modules for STP and UTP, fiber optic, and audio/video, which snap in and out for easy moves, adds, and changes

- Optional adhesive labels available
- Select faceplates feature label/label covers for easy port identification



CFFPL4

CFFP4



MFFPE

CFFPA2



CFFPE3

CFFPLA4

Panel Cutout Requirements for CFFPL4, CFFP4, MFFPE, CFFPA2, CFFPE3 and CFFPLA4:

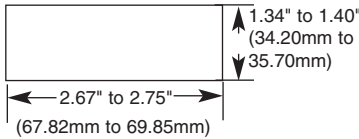

Maximum Panel Thickness: 0.09" (2.29mm)



CFFPHM4

Panel Cutout Requirements for CFFPHM4:

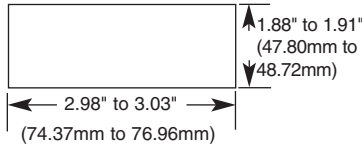

Maximum Panel Thickness: 0.09" (2.29mm)



CFFPEBSL4

Panel Cutout Requirements for CFFPEBSL4:

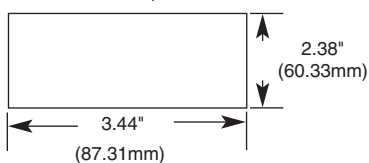

Maximum Panel Thickness: 0.05" (1.27mm)

Part Number	Part Description	Color‡	Std. Pkg. Qty.	Std. Ctn. Qty.
-------------	------------------	--------	----------------	----------------

Four Module Space Modular Furniture Snap-On Faceplate with Labels

CFFPL4BL	Faceplate snaps into industry standard knockouts found on modular furniture. Accepts up to four Mini-Com® Modules. Supplied with write-on label and label cover.	Black	1	10
-----------------	--	-------	---	----

Four Module Space Modular Furniture Snap-On Faceplate

CFFP4BL	Faceplate snaps into industry standard knockouts found on modular furniture. Accepts up to four Mini-Com® Modules.	Black	1	10
----------------	--	-------	---	----

Snap-On Modular Furniture Faceplate Extender

MFFPEBL	For use when depth inside modular furniture base is limited. Extends plate approximately 1/2" (12.7mm). Accepts CFFPL4 and CFFP4 modular faceplates.	Black	1	10
----------------	--	-------	---	----

Two Module Space Angled Modular Furniture Snap-On Faceplate

CFFPA2BL	Angled faceplate snaps into industry standard knockouts found on modular furniture. Accepts up to two Mini-Com® Modules.	Black	1	10
-----------------	--	-------	---	----

Three Module Space Extended Furniture Snap-On Faceplate

CFFPE3BL	Faceplate snaps into knockouts found on Knoll Morrison furniture as well as industry standard knockouts. Accepts up to three Mini-Com® Modules.	Black	1	10
-----------------	---	-------	---	----

Four Module Space Angled Modular Furniture Snap-On Faceplate with Labels

CFFPLA4BL	Angled faceplate snaps into industry standard knockouts found on modular furniture. Accepts up to four Mini-Com® Modules. Supplied with write-on label and label cover.	Black	1	10
------------------	---	-------	---	----

Four Module Space Herman Miller Furniture Snap-On Faceplate

CFFPHM4BL	Faceplate snaps into knockouts found on Herman Miller furniture such as Action Office Series 2 and 3 and Ethospace Baseline. Accepts up to four Mini-Com® Modules.	Black	1	10
------------------	--	-------	---	----

Four Module Space Herman Miller Ethospace Beltline Furniture Snap-On Faceplate

CFFPEBSL4BL	Sloped faceplate snaps into knockouts found on Herman Miller furniture such as Ethospace Beltline. Accepts up to four Mini-Com® Modules. Supplied with write-on label and label cover and icon slots.	Black	1	10
--------------------	---	-------	---	----

Three Module Space Knoll Equity Furniture Snap-On Faceplate

CFFPKE3BL	Faceplate snaps into knockouts found on Knoll Equity furniture. Accepts up to three Mini-Com® Modules.	Black	1	10
------------------	--	-------	---	----

Replacement Labels for Mini-Com® Snap-On Modular Furniture Faceplates

C4PPLK	Replacement label/label cover kit for Mini-Com® Modular Patch Panels with Labels (CPPL24WBLY, CPPL48WBLY, CPPL24WRBLY, CPPL48WRBLY) and Mini-Com® Modular Furniture Faceplates with Labels (CFFPL4, CFFHSL4, CFFPEBSL4). Each kit contains six labels and six clear label covers per bag.	—	1	10
---------------	---	---	---	----

‡For other colors replace suffix BL (Black) with EI (Electric Ivory), IG (International Gray), or IW (Off White). For complete labeling solutions, reference charts on pages O.1 – O.25.



CFFPKE3

Panel Cutout Requirements for CFFPKE3:

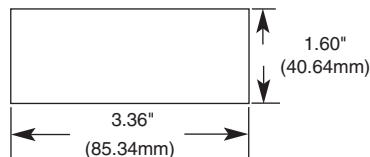

Maximum Panel Thickness: .040" (1.02mm)



C4PPLK

Component Labels for Mini-Com® Snap-On Modular Furniture Faceplates



Suggested Label Solutions for TIA/EIA-606-A Compliance

Faceplate Part Number	Laser/Ink Jet Desktop Printer Label	TDP43ME Thermal Transfer Desktop Printer Label	PanTher™ LS8E Hand-Held Printer Label	Cougar™ LS9 Hand-Held Printer Label
CFFPE3	C061X030FJJ	C061X030YPT	C061X030FJC	T031X000FJC-BK‡
CFFPKE3				
CFFP4	C125X030FJJ	C125X030YPT	C125X030FJC	T031X000FJC-BK‡
CFFPA2				
CFFPHM4				
CFFPL4	C261X035Y1J	C261X035Y1T	C261X035Y1C	T031X000FJC-BK‡
CFFPLA4				
CFFPEBSL4				

For complete labeling solutions and product information, reference charts on pages O.1 – O.25.
‡For non-adhesive labeling solution, do not remove liner from label.

UL LISTED Mini-Com® Round Faceplates

- Accept Mini-Com® Modules for STP and UTP, fiber optic, and audio/video, which snap in and out for easy moves, adds, and changes
- Optional adhesive labels available



CRFPA2BL CFFPR1BL-X

Part Number	Part Description	Color	Std. Pkg. Qty.	Std. Ctn. Qty.
CRFPA2BL	Two module space, 2" round in-floor outlet adapter.	Black	1	10
CFFPR1BL-X	One module space, 1.57" round furniture faceplate with screw.	Black	1	10

Component Labels for Mini-Com® Round Faceplates



Suggested Label Solutions for TIA/EIA-606-A Compliance

Faceplate Part Number	Laser/Ink Jet Desktop Printer Label	TDP43ME Thermal Transfer Desktop Printer Label	PanTher™ LS8E Hand-Held Printer Label	Cougar™ LS9 Hand-Held Printer Label
CRFPA2BL	C125X030FJJ	C125X030YPT	C125X030FJC	T031X000FJC-BK

For complete labeling solutions and product information, reference charts on pages O.1 – O.25.

Mini-Com® One Position Adapters

- Accept Mini-Com® Modules for STP and UTP, fiber optic, and audio/video, which snap in and out for easy moves, adds, and changes
- Allow a single module to be mounted in a variety of applications, from custom openings to specific brand products
- Snap into plastic or metal opening (size identified in part description)



CMNZABL-X



CMAA1IW-X



CBTA1WH-X



CBTA1WH-X



CBTAL1BL-X



CBTA1BL-X



CADIN1IG

Part Number	Part Description	Color‡	Std. Pkg. Qty.	Std. Ctn. Qty.
CMNZABL-X	Adapter snaps into 0.827" x 0.827" (21mm x 21mm) opening and accepts one Mini-Com® Module. For snug fit, panel thickness should be 0.046" to 0.056" (11.7mm to 14.2mm).	Black	10	50
CMAA1IW-X	Adapter snaps into 1" x 1" (25mm x 25mm) opening and accepts one Mini-Com® Module. For snug fit, panel thickness should be 0.06" to 0.08" (1.5mm to 2.0mm).	Off White	10	100
CBTAL1WH-X	Adapter with label pocket accepts one Mini-Com™ Module, for Bticino Light series faceplates.	White	10	50
CBTA1WH-X	Adapter accepts one Mini-Com™ Module, for Bticino Light series faceplates.	White	10	50
CBTAL1BL-X	Adapter with label pocket accepts one Mini-Com™ Module, for Bticino Living International series faceplates.	Black	10	50
CBTA1BL-X	Adapter accepts one Mini-Com™ Module, for Bticino Living International series faceplates.	Black	10	50
CADIN1IG	Mini-Com® DIN Rail Mount Adapter mounts to standard 35mm DIN rail and accepts any single port Mini-Com® Module. Includes a label and label cover.	International Gray	1	10

‡For other colors substitute suffix BL (Black) or IW (Off White) with WH (White).
*Bticino is a division of Legrand Group.



Mini-Com® Ultimate ID® Hybrid Box

- Ultimate ID® components are part of a complete system for identification designed to efficiently support TIA/EIA-606-A standard labeling requirements and TIA/EIA-568-B MUTOA requirements
- Accepts Mini-Com® Modules for STP and UTP, fiber optic, and audio/video, which snap in and out for easy moves, adds, and changes
- Provides independent access to copper and fiber optic connections
- Mounts to single gang, double gang, or DIN opening
- A retention block snaps to the base and accepts any single gang faceplate (up to six ports)
- Base accepts up to six Mini-Com® Fiber Optic Modules
- Manages up to 12 meters of buffered fiber optic cable that is secured in place by cable tie mounting loops
- Cover snaps to base and is secured with a screw; includes a 6-position Ultimate ID® Label Pocket to identify fiber optic connections; a clear screw cover is included for station identification
- Can be clearly identified with PanTher™ LS8E or Cougar™ LS9 Hand-Held Thermal Transfer Printers
- Non-adhesive computer printable label sheets for printers and write-on labels available
- Optional cover extension provides additional security of fiber connections
- Heat shrink tubing included



UICBXH6IW-A UICBXHECIW



Part Number	Part Description	Color‡	Labels Required*	Used with Pan-Way® Raceway	Std. Pkg. Qty.	Std. Ctn. Qty.
UICBXH6IW-A	Hybrid box with cover accepts up to six Mini-Com® Modules in a single gang Mini-Com® Faceplate, and up to six Mini-Com® Fiber Optic Modules in the base.	Off White	One 1-Port One 6-Port	LD3, LD5	1	10
UICBXHC6IW-A	Hybrid box with cover and cover extension accepts up to six Mini-Com® Modules in a single gang Mini-Com® Faceplate, and up to six Mini-Com® Fiber Optic Modules in the base.	Off White	One 1-Port One 6-Port	LD3, LD5	1	10
UICBXHECIW	Cover extension for hybrid box.	Off White	—	—	1	10

‡ For other colors replace suffix IW (Off White) with EI (Electric Ivory) or WH (White).
*Ultimate ID® Labels can be found on pages O.11 and O.21.



Mini-Com® Ultimate ID® Surface Mount Boxes

- Ultimate ID® components are part of a complete system for identification designed to efficiently support TIA/EIA-606-A standard labeling requirements; reference page A.17 for a complete system overview
- Accept Mini-Com® Modules for STP and UTP, fiber optic, and audio/video, which snap in and out for easy moves, adds, and changes
- Supplied with color coordinated screw cover and clear station and port label covers, labels sold separately
- 4-port box includes adjustable mounting tabs that enable a range of modular furniture partitions to be used for mounting the box, maximum panel thickness 0.08"
- Can be clearly identified with PanTher™ LS8E or Cougar™ LS9 Hand-Held Thermal Transfer Printers
- Non-adhesive computer printable label sheets for desktop printers and write-on labels available
- Replacement screw covers and label covers available
- Optional icons available
- Custom mounting screws included
- Mount easily with supplied mounting screws, adhesive tape, or optional magnet



UICBX2IW-A



UICBX4IW-A

Part Number	Part Description	Color‡	Labels Required*	Used with Pan-Way® Raceway	Std. Pkg. Qty.	Std. Ctn. Qty.
UICBX2IW-A	Surface mount box accepts two Mini-Com® Modules. Dimensions: 1.06"H x 1.95"W x 3.65"L (26.92mm H x 49.53mm W x 92.71mm L).	Off White	One 1-Port One 2-Port	LD3	1	10
UICBX4IW-A	Surface mount box accepts four Mini-Com® Modules. Dimensions: 1.06"H x 3.69"W x 4.59"L (26.92mm H x 93.73mm W x 116.59mm L).	Off White	One 1-Port One 4-Port	LD3, LD5	1	10

‡For other colors replace suffix IW (Off White) with IG (International Gray), WH (White), or EI (Electric Ivory). Part number UICBX2IW-A compatible with CBM-X magnet, UICBX4IW-A compatible with CSBM-X magnet.
*Ultimate ID® Labels can be found on pages O.11 and O.21.



Mini-Com® Surface Mount Boxes

- Accept Mini-Com® Modules for STP and UTP, fiber optic, and audio/video, which snap in and out for easy moves, adds, and changes
- Mount easily with supplied mounting screws, adhesive tape, or optional magnet (CBM-X)
- Cable entry from side and rear knockouts and from opening in center of base
- CBXJ2 and CBX2 include built-in removable blank to add a second module
- Optional adhesive labels available



CBX1IW-A

CBXJ2IW-A



CBX2IW-AY

CBXC4IW-A

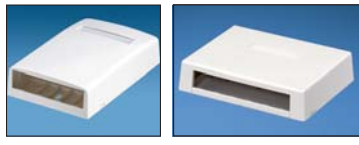

CBX4IW-AY

CBXD6IW-AY



CBX12IW-AY

Part Number	Part Description	Color†	Used with Pan-Way® Raceway	Std. Pkg. Qty.	Std. Ctn. Qty.
CBX1IW-A	Surface mount box accepts one Mini-Com® Module. Dimensions: 0.9"H x 1.01"W x 1.88"L (22.86mm x 25.65mm x 47.75mm). Rear knockout provides opening of 0.42"H x 0.26"W.	Off White	LD3, LDS3*, LDPH5	1	10
CBXJ2IW-A	Surface mount box accepts one or two Mini-Com® Modules; includes built-in removable blank to add a second module. Dimensions: 0.91"H x 1.77"W x 2.44"L (23.11mm x 44.96mm x 61.98mm). Knockout provides opening of 0.47"H x 0.36"W.	Off White	LD5, LDPH5*	1	10
CBX2IW-AY	Surface mount box accepts one or two Mini-Com® Modules; includes built-in removable blank to add a second module. Dimensions: 1.06"H x 1.95"W x 3.65"L (26.92mm x 49.53mm x 92.71mm).	Off White	LD3, LDPH3, LD5, LDPH5	1	10
CBXC4IW-A	Surface mount box accepts four Mini-Com® Modules. Dimensions: 0.91"H x 3.20"W x 3.20"L (23mm x 80mm x 80mm).	Off White	LDPH5	1	10
CBX4IW-AY	Surface mount box accepts four Mini-Com® Modules. Provides slots that accept cable ties for strain relief. Supplied with label holder/screw cover. Dimensions: 1.1"H x 2.9"W x 4.5"L (27.94mm x 73.66mm x 114.30mm).	Off White	LD3, LDPH3, LD5, LDPH5	1	10
CBXD6IW-AY	Surface mount box accepts six Mini-Com® Modules. Provides slots that accept cable ties for strain relief. Provides bend radius control. Supplied with label holder/screw cover. Dimensions: 1.04"H x 4.95"W x 3.79"L (26.42mm x 125.73mm x 96.27mm).	Off White	LD3, LD5, LD10	1	10
CBX12IW-AY	Surface mount box holds up to twelve Mini-Com® Modules, six on each side. Supplied with mounting screws, adhesive backing, and label holder/screw cover. Dimensions: 1.035"H x 5.71"W x 5.45"L (26mm x 145mm x 138mm).	Off White	LD5, LD10	1	10

†For other colors replace suffix IW (Off White) with EI (Electric Ivory), WH (White), IG (International Gray), or BL (Black).

*Raceway does not enter box.

Surface mount boxes do not accept icons.

Component Labels for Mini-Com® Surface Mount Boxes



Suggested Label Solutions for TIA/EIA-606-A Compliance

Box Part Number	Laser/Ink Jet Desktop Printer Label	TDP43ME Thermal Transfer Desktop Printer Label	PanTher™ LS8E Hand-Held Printer Label	Cougar™ LS9 Hand-Held Printer Label
CBX1**-A	C061X030FJJ	C061X030YPT	C061X030FJC	T031X000FJC-BK
CBXJ2**-A	C125X030FJJ	C125X030YPT	C125X030FJC	
CBX2**-AY	C252X030FJJ	C252X030YPT	C252X030FJC	
CBXC4**-A	C379X030FJJ	C379X030YPT	C379X030FJC	
CBX4**-AY				
CBXD6**-AY				
CBX12**-AY				

For complete labeling solutions and product information, reference charts on pages O.1 – O.25.



Mini-Com® Shuttered Surface Mount Boxes

- Accept Mini-Com® Modules for STP and UTP, FJ® Fiber Optic Jack Modules and other flush modules, which snap in and out for easy moves, adds, and changes
- Clear shuttered doors are spring-loaded to stay closed to prevent dust from entering module opening; doors can be collapsed to insert plug into module
- Cable entry from side, rear, and base knockouts
- Mount easily with supplied mounting screws, adhesive tape, or optional magnet (CSBM-X)
- Optional icons available
- Optional adhesive labels available



CBXS1IW-A



CBXS2IW-A



CBXS3IW-AY



CBXS4IW-AY



CBXS6IW-AY



CBXSD6IW-AY

Part Number	Part Description	Color‡	Used with Pan-Way® Raceway	Std. Pkg. Qty.	Std. Ctn. Qty.
CBXS1IW-A	Shuttered surface mount box accepts one Mini-Com® Module. 0.62"H x 1.64"W x 2.47"L (15.75mm x 41.66mm x 62.73mm)	Off White	LD5/LDPH5*	1	10
CBXS2IW-A	Shuttered surface mount box accepts two Mini-Com® Modules. 0.94"H x 2.40"W x 2.5"L (23.88mm x 60.96mm x 63.50mm)	Off White	LD5/LDPH5*	1	10
CBXS3IW-AY	Shuttered surface mount box accepts three Mini-Com® Modules. 0.94"H x 3.62"W x 3.31"L (23.88mm x 92.00mm x 84.00mm)	Off White	LD5/LDPH5	1	10
CBXS4IW-AY	Shuttered surface mount box accepts four Mini-Com® Modules. 0.94"H x 4.65"W x 3.28"L (23.88mm x 118.11mm x 83.31mm)	Off White	LD3/LDPH3 LD5/LDPH5	1	10
CBXS6IW-AY	Shuttered surface mount box accepts six Mini-Com® Modules. 0.94"H x 6.7"W x 3.28"L (23.88mm x 170.18mm x 83.31mm)	Off White	LD3/LDPH3 LD5/LDPH5	1	10
CBXSD6IW-AY	Deep shuttered surface mount box accepts six Mini-Com® Modules (includes cable routing bridge). 1.16"H x 7.58"W x 3.86"L (29.60mm x 192.50mm x 98.00mm).	Off White	LD5/LDPH5 LD10/ LDPH10	1	10

‡For other colors replace suffix IW (Off White) with EI (Electric Ivory), WH (White), IG (International Gray), or BL (Black).

*Raceway does not enter box.

Component Labels for Mini-Com® Shuttered Surface Mount Boxes



Suggested Label Solutions for TIA/EIA-606-A Compliance

Box Part Number	Laser/Ink Jet Desktop Printer Label	TDP43ME Thermal Transfer Desktop Printer Label	PanTher™ LS8E Hand-Held Printer Label	Cougar™ LS9 Hand-Held Printer Label
CBXS1**-A	C061X030FJJ	C061X030YPT	C061X030FJC	T031X000FJC-BK
CBXS2**-A				
CBXS3**-A				
CBXS4**-A				
CBXS6**-A				
CBXSD6**-A				

For complete labeling solutions and product information, reference charts on pages O.1 – O.25.



Mini-Com® Ultimate ID® Multi-Media/Fiber Surface Mount Box

- Ultimate ID® components are part of a complete system for identification designed to efficiently support TIA/EIA-606-A standard labeling requirements
- Accepts Mini-Com® Modules for STP and UTP, fiber optic, and audio/video, which snap in and out for easy moves, adds, and changes
- Features twelve ports, six on each side, angled to improve bend radius control
- Includes two knockouts which are compatible with Panduit LD5 and LD10 raceway
- Mounts to single or double gang opening

- Mounts easily with supplied mounting screws, adhesive tape, or optional magnet (CSBM-X)
- Supplied with clear station and port label covers, labels sold separately
- Can be clearly identified with the PanTher™ LS8E or Cougar™ LS9 Hand-Held Thermal Transfer Printers
- Non-adhesive computer printable label sheets for desktop printers and write-on labels available
- Replacement label covers available
- Optional icons available



Part Number	Part Description	Color‡	Labels Required*	Std. Pkg. Qty.	Std. Ctn. Qty.
UICBXA12IW-A	Multi-media surface mount box accepts up to twelve Mini-Com® Modules and includes built-in figure eight spool to help manage fiber cable.	Off White	Two 4-Port Two 6-Port	1	10

‡ For other colors replace suffix IW (Off White) with EI (Electric Ivory) or WH (White).
All surface mount boxes supplied with mounting screws.
*Ultimate ID® Labels can be found on pages O.11 and O.21.



Mini-Com® Multi-Media/Fiber Surface Mount Boxes

- Accept Mini-Com® Modules for STP and UTP, fiber optic, and audio/video, which snap in and out for easy moves, adds, and changes
- Mount easily with supplied mounting screws or adhesive tape
- Cable tie slots for improved cable management
- Tamper resistant screw for added security

- Unique built-in fiber spool design secures cable in place and stores up to 78.8 feet (24 meters) of buffered fiber optic cable
- Cable entry from side and rear knockouts and from opening in bottom of base
- Optional adhesive labels available
- Combination label/label cover for custom outlet identification



CBXF6IW-AY



CBXF12IW-AY

Part Number	Part Description	Color‡	Used with Pan-Way® Raceway	Std. Pkg. Qty.	Std. Ctn. Qty.
CBXF6IW-AY	Surface mount box accepts up to six Mini-Com® Modules. Icon slots available for optional icons. 0.99"H x 4.71"W x 6.67"L (25mm x 120mm x 170mm)	Off White	LD3/LD5	1	10
CBXF12IW-AY	Surface mount box accepts up to twelve Mini-Com® Modules. 1.81"H x 4.71"W x 6.67"L (46mm x 120mm x 170mm).	Off White	LD3/LD5/LD10	1	10

‡For other colors replace suffix IW (Off White) with EI (Electric Ivory), WH (White), IG (International Gray), or BL (Black).

Component Labels for Mini-Com[®] Multi-Media/Fiber Surface Mount Boxes

Suggested Label Solutions for TIA/EIA-606-A Compliance				
Faceplate Part Number	Laser/Ink Jet Desktop Printer Label	TDP43ME Thermal Transfer Desktop Printer Label	PanTher™ LS8E Hand-Held Printer Label	Cougar™ LS9 Hand-Held Printer Label
CBXF6**	C379X030FJJ	C379X030YPT	C379X030FJC	T031X000FJC-BK
CBXF12**-AY				

For complete labeling solutions and product information, reference charts on pages O.1 – O.25.

Mini-Com[®] MuTOA 6-Port Outlet Box

- Accepts Mini-Com[®] Modules for STP and UTP, fiber optic, and audio/video, which snap in and out for easy moves, adds, and changes
- Mounts easily with adhesive tape or optional magnet (CSBM-X)
- Two pass-through holes allow surface mounting with screws (not included)
- Expandable cable opening will adjust to different cable bundle sizes
- Accepts up to three 1/2 size sloped inserts (shuttered or non-shuttered) for up to six modules (inserts and modules not included)
- Two mounting eyelets (by the cable opening) allow the MuTOA to be suspended
- Cable tie support slot will hold cable bundle in place during assembly
- Ideal for pre-assembled cable runs



Part Number	Part Description	Color‡	Std. Pkg. Qty.	Std. Ctn. Qty.
CM6PIW	MuTOA 6-port outlet box accepts up to six Mini-Com [®] Modules when using 1/2 size sloped inserts. Cable entry opening: 0.695" (17.7mm) to 0.825" (21.0mm) Dia.; Overall dimensions: 2.36"H x 1.81"W x 7.90"L (59.9mm x 46mm x 200.7mm).	Off White	1	10

‡For other colors replace suffix IW (Off White) with EI (Electric Ivory), WH (White), IG (International Gray), BL (Black), or CL (Clear).

A complete listing of inserts can be found on page G.15.

Component Labels for Mini-Com[®] MuTOA 6-Port Outlet Box

Suggested Label Solutions for TIA/EIA-606-A Compliance				
Faceplate Part Number	Laser/Ink Jet Desktop Printer Label	TDP43ME Thermal Transfer Desktop Printer Label	PanTher™ LS8E Hand-Held Printer Label	Cougar™ LS9 Hand-Held Printer Label
CM6PIW	C125X030FJJ	C125X030YPT	C125X030FJC	T031X000FJC-BK

For complete labeling solutions and product information, reference charts on pages O.1 – O.25.

Optional Magnets

- Used to mount surface mount boxes to metal surfaces



Part Number	Part Description	Std. Pkg. Qty.	Std. Ctn. Qty.
CBM-X	Magnet for non-shuttered version surface mount boxes.	10	100
CSBM-X	Magnet for shuttered version surface mount boxes.	10	100

Ultimate ID® Icons

- Provide port identification of data and voice applications
- Compatible with Ultimate ID® Surface Mount Boxes, Faceplates, and Patch Panel Faceplates
- Mount flush with Ultimate ID® Label Pocket

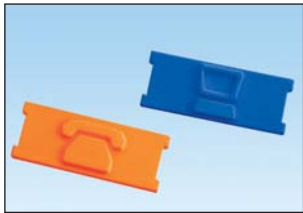

Part Number	Part Description	Color‡	Std. Pkg. Qty.	Std. Ctn. Qty.
UICIDIW-C	Plastic snap-in icon with data image.	Off White	100	1000
UICIPIW-C	Plastic snap-in icon with phone image.	Off White	100	1000

‡For other colors replace suffix IW (Off White) with EI (Electric Ivory), WH (White), IG (International Gray), BL (Black), OR (Orange), RD (Red), BU (Blue), GR (Green), YL (Yellow), or VL (Violet).
Ultimate ID® Icons are not TIA/EIA-606-A standard compliant.
See page G.28 for Mini-Com® Icons.

Ultimate ID® Replacement Label Covers and Screw Covers

- For use with Ultimate ID® Faceplates, Patch Panels, Hook and Loop Marker Ties, and Surface Mount Boxes
- Ultimate ID® components are part of a complete system for identification designed to efficiently support TIA/EIA-606-A standard labeling requirements



Part Number	Part Description	Color‡	Std. Pkg. Qty.	Std. Ctn. Qty.
UILC1CL-X	1-port label or screw cover.	Clear	10	100
UILC2CL-X	2-port label cover.	Clear	10	100
UILC3CL-X	3-port label cover.	Clear	10	100
UILC4CL-X	4-port label cover.	Clear	10	100
UILC6CL-X	6-port label cover.	Clear	10	100

‡For other colors replace CL (Clear) with appropriate color designation to match Ultimate ID® component.
See pages G.28 and G.29 for Mini-Com® Replacement Screw Covers and Replacement Label Covers.

Ultimate ID[®] Write-On Labels

- Write-on labels for use with Ultimate ID[®] Faceplates, Surface Mount Boxes, and Patch Panels

- Ultimate ID[®] components are part of a complete system for identification designed to efficiently support TIA/EIA-606-A standard labeling requirements

**UIWOL2**

Part Number	Part Description	Color	Std. Pkg. Qty.	Std. Ctn. Qty.
UIWOL1-L	1-port, white non-adhesive polyester write-on label.	White	50	250
UIWOL2-L	2-port, white non-adhesive polyester write-on label.	White	50	250
UIWOL3-L	3-port, white non-adhesive polyester write-on label.	White	50	250
UIWOL4-L	4-port, white non-adhesive polyester write-on label.	White	50	250
UIWOL6-L	6-port, white non-adhesive polyester write-on label.	White	50	250

The TIA/EIA-606-A standard states that all labels shall be mechanically generated, write-on labels are not standard compliant.

Icons

- Provide port identification of data and voice installations
- Offered in a variety of colors for color coding requirements
- Snap into dedicated slot of select Mini-Com[®] Modules, Surface Mount Boxes, and Faceplates



Part Number	Part Description	Color‡	Std. Pkg. Qty.	Std. Ctn. Qty.
CIPIW-C	Plastic snap-in icon with phone image.	Off White	100	1000
CIDIW-C	Plastic snap-in icon with data image.	Off White	100	1000

‡For other colors replace suffix IW (Off White) with EI (Electric Ivory), WH (White), IG (International Gray), BL (Black), OR (Orange), RD (Red), BU (Blue), GR (Green), YL (Yellow), or VL (Violet).
Icons with lettering available, contact Panduit Customer Service.

Replacement Screw Cover

- For use in place of clear label covers for select surface mount boxes and single gang faceplates



Part Number	Part Description	Color‡	Std. Pkg. Qty.	Std. Ctn. Qty.
CSCIW-X	Screw cover has a textured surface and blends with the faceplates and surface mount boxes for improved aesthetics.	Off White	10	100

‡For other colors replace suffix IW (Off White) with EI (Electric Ivory), WH (White), IG (International Gray), or BL (Black).

Replacement Label/Label Cover Kits

- For use with Mini-Com® Executive and Classic Series Faceplates with Labels and select Mini-Com® Surface Mount Boxes



CSGLLC-L

Part Number	Part Description	Std. Pkg. Qty.	Std. Ctn. Qty.
Label/Label Cover Kit			
CSGLLC-L	Single gang Mini-Com® Label/Label Cover Kit. Each kit contains 50 labels and 50 clear label covers.	50	250
Label/Label Cover Kits with Screws			
EFPK-XY	Single gang label/label cover and two screws. Also works with select surface mount boxes.	10	50
EFPK102G-XY	Double gang label/label cover and four screws.	10	50

Low Voltage Mounting Brackets

- Choose design styles for new install or retrofit install
- Available in both single and double gang configurations



Part Number	Part Description	Std. Ctn. Qty.
LV-S-1G	Low voltage integral mounting bracket for new installations, single gang stud bracket.	25
LV-S-2G	Low voltage integral mounting bracket for new installations, double gang stud bracket.	25
LV-W-1G	Low voltage mounting bracket for retrofit installations; single gang box with screws; suitable for wall material thicknesses of 1/2" to 1 1/2".	100
LV-W-2G	Low voltage mounting bracket for retrofit installations; double gang box with screws; suitable for wall material thicknesses of 1/2" to 1 1/2".	50

Depth to Rear of Module Reference Guide

Part Number	All TG Style Modules		TX Style Modules		Leadframe Modules	
	In.	mm	In.	mm	In.	mm
Mini-Com® Classic Series Faceplates with Label and Label Cover						
CFPL2**Y, CFPL3**Y, CFPL4**Y, CFPL6**Y	1.23	31.2	1.16	29.5	1.11	28.2
Mini-Com® Classic Series Dedicated Sloped Faceplates						
CFPHS2**, CFPSL2**, CFPHSL4**, CFPSL4**, CFPSL6**	0.95	24.1	0.76	19.3	0.80	20.3
Mini-Com® Classic Series Vertical Faceplates						
CFP1**, CFP2**, CFP4**	1.24	31.5	1.17	29.7	1.12	28.4
Mini-Com® Classic Series Horizontal Faceplates						
CFPH2**, CFP4**	1.24	31.5	1.17	29.7	1.12	28.4
Mini-Com® Classic Series Faceplate Kits						
CFPS4**	0.80	20.3	0.80	20.3	0.80	20.3
CFPF12**-2G	1.24	31.5	1.17	29.7	1.12	28.4
Mini-Com® Executive Series Faceplates						
CFPE1**Y, CFPE2**Y, CFPE4**Y, CFPE6**Y, CFPE10**-2GY	0.99	25.1	0.92	23.4	0.87	22.1
Mini-Com® Executive Series Faceplate Kit						
CFPSE4**Y	0.66	16.8	0.66	16.8	0.63	16.0
Mini-Com® Industrial Faceplates						
CFPWR4**, CFPTR4**, CFPTR2**	1.26	32.0	1.17	29.7	1.29	32.8
Mini-Com® Faceplate Frames for Sloped, Flat, and Blank Module Inserts						
CB**, CB**-2G						
Flat	1.24	31.5	0.76	19.3	1.12	28.4
Sloped	0.80	20.3	0.80	20.3	0.80	20.3
Recessed	1.36	34.5	1.36	34.5	1.33	33.8
30 degree insert	1.79	45.5	1.79	45.5	1.77	45.0
CBE**, CBE**-2GY						
Flat	0.99	25.1	0.92	23.4	0.87	22.1
Sloped	0.66	16.8	0.66	16.8	0.63	16.0
Recessed	1.46	37.1	1.46	37.1	1.43	36.3
30 degree insert	1.54	39.1	1.54	39.1	1.52	38.6
Mini-Com® 106 Duplex Module Frames						
CF1062**Y	1.24	31.5	1.17	29.7	1.12	28.4
CF1064**Y	1.26	32.0	1.19	30.2	1.14	28.9
Mini-Com® "GFCI" Decora Module Frames						
CFG1, CFG2, CFG4, and CFG6	1.26	32.0	1.18	29.9	1.07	27.1
Executive Series Faceplates						
ECPG**, ECPG**-2G	0.97	24.6	0.90	22.9	0.85	21.6
Stainless Steel Faceplates including Ultimate ID® Faceplates						
CFP(L)2SY, UICFP2S	1.26	32.0	1.19	30.2	1.14	29.0
CFP(L)4SY, UICFP4S	1.26	32.0	1.19	30.2	1.14	29.0
CFP(L)6SY, UICFP6S	1.26	32.0	1.19	30.2	1.14	29.0
CFP(L)4S-2GY	1.26	32.0	1.19	30.2	1.14	29.0
CFP(L)6S-2GY	1.26	32.0	1.19	30.2	1.14	29.0
CFP(L)8S-2GY	1.26	32.0	1.19	30.2	1.14	29.0
CFP(L)10S-2GY	1.26	32.0	1.19	30.2	1.14	29.0
In-Wall Box Adapter						
MIWBA**	Subtract .22" or 5.6mm from depth to rear of module modular furniture faceplate measurement					
Mini-Com® Snap-On Modular Furniture Faceplates						
CFFPL4** CFFP4**	1.10	27.9	1.01	25.7	0.96	24.4
CFFPA2**	0.86	21.8	0.77	19.6	0.60	15.2
MFFPE**	Subtract .50" or 12.7mm from depth to rear of module modular furniture faceplate measurement					
CFFPHM4**	1.09	27.7	1.01	25.7	0.96	24.4
CFFPEBSL4**	0.49	12.4	0.49	12.4	0.44	11.2
CFFPLA**	0.90	22.9	0.73	18.5	0.72	18.2
CFFPE3**	0.49	12.4	0.41	10.4	0.39	9.8
CFFPKE3**	0.25	6.3	0.15	3.7	0.14	3.6
Round Faceplates						
CRFPA2**	1.49	37.8	1.42	36.1	1.37	34.8
CFFPR1**X	1.50	38.1	1.43	36.3	1.38	35.1
Mini-Com® Ultimate ID® Executive Series Faceplates						
UICFPSE2**	0.73	18.5	0.55	14.0	0.55	14.0
UICFPSE4** UICFPSE6**	0.73	18.5	0.55	14.0	0.55	14.0
UICFPHSE2**	0.73	18.5	0.55	14.0	0.55	14.0
UICFPHSE4** UICFPSE8**-2G	0.73	18.5	0.55	14.0	0.55	14.0
Mini-Com® Ultimate ID® Tamper Resistant Faceplate						
UICFPRTR4						
Flat	1.50	38.1	1.43	36.3	1.38	35.1
Sloped	1.22	31.0	1.04	26.4	0.79	20.1
Recessed	1.62	41.1	1.62	41.1	1.59	40.4
30 degree insert	1.67	42.4	1.67	42.4	1.68	42.7
Mini-Com® Ultimate ID® Classic Series Faceplates						
UICFP2**, UICFP4**, UICFP6**, UICFPH2**, UICFPH4**	1.23	31.2	1.16	29.5	1.11	28.2
Mini-Com® Ultimate ID® Modular Furniture Faceplate						
UICFFP4BL	0.86	21.8	0.79	20.1	0.74	18.8
Keystone Phone Plate with Keystone Module						
KWP5EY and KWP6PY	—	—	1.00	25.4	—	—

**Replace ** with color code to designate color. See item tables for colors available.

MEDIA DISTRIBUTION SYSTEM

The Panduit media distribution system offers a flexible and comprehensive way to distribute voice, video, and data (commonly referred to as triple play services) to commercial or residential locations within a multi-unit building. The innovative system consolidates all incoming communication cabling within an enclosure and efficiently distributes the services to individual outlets within the home or office.



- Provides high-density capacity by supporting a greater number of connections in a smaller enclosure, as compared to similar products
- Offers a modular design that provides flexibility to mix and match triple play services and to easily modify those services as needs change
- Consolidates all incoming communication cable into one centralized location to simplify installations and troubleshooting

The media distribution system includes enclosures, voice and data hubs, patch panel, video splitters, and multiple accessories, providing flexibility and choice to meet individual cabling needs.

The Panduit media distribution system complements an extensive line of Panduit offerings (including A/V modules, faceplates, copper cabling and jacks, patch panels, and cable management) to enable a complete network infrastructure from the building demarcation point to the end user's network outlet.

Media Distribution Enclosures System Roadmap



1 Enclosures (page H.3)



2 Voice (Phone) Hubs (page H.4)



3 Video Splitters (page H.4)



4 Data Hubs (page H.5)



5 Accessories (page H.5)

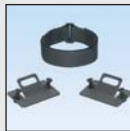

6 Faceplates (page G.3 – G.14)



7 A/V Modules (pages B.58 – B.64)



8 Jack Modules (pages B.16, B.17, B.20, B.21, B.28, B.29, B.36, B.37, B.40 - B.42, B.48, B.49, B.55, and B.58 – B.64)



9 Fiber Optic Adapter Modules (pages C.31 – C.36)



10 Patch Cords (pages B.18, B.25, B.34, B.46, and B.50)



11 Modular Patch Panels (pages B.66 – B.73)

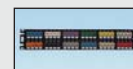

Media Distribution Enclosures

- 1" grid pattern in base provides mounting and flexibility for the hubs
- Multiple 2.5" knockouts at top and bottom for cable entry and exit
- Include two single gang power knockouts
- Cantilever mounting slots flex to accommodate misaligned studs
- Shear forms along sidewalls to help route and secure cable in place
- Drywall positioning slots



MS14B



MS14HD



MS14BHD



MS24B



MS24HD



MS24BHD



MSB14E



MSB24E

Part Number	Part Description	Std. Pkg. Qty.
Advanced Enclosures		
MS14B	14" x 14" media distribution enclosure base. 14.25"H x 14.25"W x 4.00"D (362.0mm x 362.00mm x 101.6mm).	1
MS14HD	14" x 14" hinged door with lock and key. 15.81"H x 15.75"W x .87"D (401.6mm x 400.00mm x 22.1mm).	1
MS14BHD	14" x 14" frameless hinged door with slam latch. 15.75"H x 15.75"W x 0.63"D (400mm x 400mm x 15.9mm).	1
MS24B	14" x 24" media distribution enclosure base. 24.25"H x 14.25"W x 4.00"D (616.0mm x 362.00mm x 101.6mm).	1
MS24HD	14" x 24" hinged door with lock and key. 25.81"H x 15.75"W x .87"D (655.6mm x 400.00mm x 22.1mm).	1
MS24BHD	14" x 24" frameless hinged door with slam latch. 15.75"H x 25.75"W x 0.63"D (400mm x 654mm x 15.9mm).	1
Basic Enclosures		
MSB14E	14" x 14" media distribution basic enclosure with screw down door. 14.25"H x 14.25"W x 4.00"D (362.0mm x 362.00mm x 101.6mm).	1
MSB24E	14" x 24" media distribution basic enclosure with screw down door. 24.25"H x 14.25"W x 4.00"D (616.0mm x 362.00mm x 101.6mm).	1

Base and door for advanced enclosures sold separately.
All product color is white.

Media Distribution Voice Hubs

- Manage up to four incoming lines and distribute service to eight outlets per line
- Offer built-in cable mounts to help organize and route cable
- Provide stackability feature to save space and increase the density of an installation
- Snap directly onto grid patterns within enclosures to simplify installations and allow easy moves, adds, and changes

**MS8PD**

Part Number	Part Description	Std. Pkg. Qty.	Std. Ctn. Qty.
MS8PD	Phone distribution hub that includes test ports and a built-in security interface switch that can override phone service in emergency situations.	1	10
MS8PE	Phone expansion hub that adds up to eight additional phone connections per line.	1	10

All product color is black.

**MS8PE**

Media Distribution Video Splitters

- Split incoming video/coax to distribute service throughout the unit
- Pre-mounted onto metal bracket for quick installation
- Include grounding screws
- Snap directly onto grid patterns within enclosures to simplify installations and allow easy moves, adds, and changes

**MS4S1G
and
MS4S2G**

Part Number	Part Description	Std. Pkg. Qty.	Std. Ctn. Qty.
1 GHz Splitters			
MS4S1G	Media distribution 1 x 4 passive video splitter with 1 GHz performance to distribute high-quality RF signals to up to four outputs.	1	10
MS8S1G	Media distribution 1 x 8 passive video splitter with 1 GHz performance to distribute high-quality RF signals to up to eight outputs.	1	10

**MS8S1G
and
MS8S2G**

2 GHz Splitters			
MS4S2G	Media distribution 1 x 4 passive video splitter with 2 GHz performance to distribute high-quality RF signals to up to four outputs.	1	10
MS8S2G	Media distribution 1 x 8 passive video splitter with 2 GHz performance to distribute high-quality RF signals to up to eight outputs.	1	10

Media Distribution Data Hub

- Distributes media and data service
- Allows for fast and effective terminations
- Offers built-in cable mounts to help organize and route cable
- Provides stackability feature to save space and increase the density of an installation
- Snaps directly onto grid patterns within enclosures to simplify installations and allow easy moves, adds, and changes



Part Number	Part Description	Std. Pkg. Qty.	Std. Ctn. Qty.
MS5E6PP	Media distribution data hub with Category 5e performance that distributes media and data to up to six different locations; includes front-side 110 punchdown terminations.	1	10

All product color is black.

Media Distribution Accessories

- Support media distribution voice hubs, data hub, and video splitters



MS8PP



MSEBRKT



MSCM-KIT



MSGRD-KIT



MSCLK



MSCMR

Part Number	Part Description	Std. Pkg. Qty.	Std. Ctn. Qty.
MS8PP	Media distribution Mini-Com® Patch Panel that accepts all Mini-Com® Modules, providing a Category 6 solution to distribute media and data to up to eight different locations.	1	10
MSEBRKT	Media distribution equipment bracket that allows a variety of third-party equipment to be securely mounted within an enclosure.	1	10
MSCM-KIT	Media distribution cable management kit that includes the necessary components to help manage cables.	1	10
MSGRD-KIT	Media distribution grounding kit that includes necessary components to help ground media distribution advanced enclosures.	1	10
MSCLK	Lock and key for frameless hinged door.	1	10
MSCMR	Media distribution cable management ring.	1	10

All product color is black.

NOTES



PHYSICAL INFRASTRUCTURE MANAGEMENT SYSTEM

Research shows that half of all network problems arise from issues in the physical infrastructure. Yet the physical infrastructure is largely overlooked. Without real-time monitoring and visibility into dense physical layer connectivity and related data center infrastructure information, enterprises are vulnerable to a number of risks, such as unnecessary downtime and underutilized resources.

Panduit provides complete visibility of the data center and extended enterprise through intelligent devices and software-based automation, change management, and related documentation that integrates with higher-level network management and services desk platforms. This combined approach helps optimize data center operations as enterprises embark on virtualization and cloud computing initiatives.

The Physical Infrastructure Manager™ (PIM™) Software Platform is an enterprise class Data Center Infrastructure Management (DCIM) tool that combines connectivity management data with asset tracking, allocation, and utilization information, enabling you to reclaim and repurpose IT assets effectively. PIM™ Software centralizes the collection and representation of a rich set of asset attributes, such as connectivity, space/port availability, and power/environmentals, to ensure that your physical infrastructure supports mission-critical applications, and enables effective optimization of your data center's space, power, and cooling resources.



Front View



Rear View

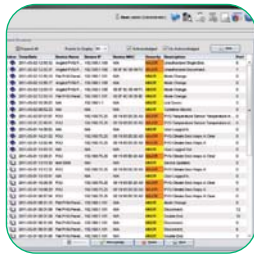

- Provide real-time information on network status and monitor connectivity
- Facilitate planning, implementation, and documentation of connectivity moves, adds, or changes
- Monitor and alert administrators of any patch field changes or potential connectivity-based security risks
- Simplify user interaction via web-based management system
- Interface with third-party network management system programs, help desk applications, and other enterprise systems

Panduit's modular approach to delivering DCIM functionality enables you to customize the solution to meet the needs of your organization both now and in the future. Process-driven integration with your current network management and service desk platforms delivers a streamlined interface to support management of IT assets with related attributes and physical infrastructure components of your data center and extended enterprise.



The PanView iQ™ (PViQ™) System supports interconnect configurations that monitor connectivity between a network switch and monitored PanView iQ™ Patch Panels, delivering enhanced port security. This configuration is particularly beneficial in data center applications where rack space optimization is critical. The PanView iQ™ System can also support cross-connect configurations to implement a protected patch field where each switch and server port is represented via a port on a PanView iQ™ Patch Panel.

Additional information on the Physical Infrastructure Manager™ (PIM™) Software Platform and PanView iQ™ System can be found in the solutions brochures SA-PVCB24 and SA-PVCB20, and on the Panduit website at <http://www.panduit.com/pim>.

REVOLUTIONARY!

PanView iQ™ Interconnect Solution for the Enterprise

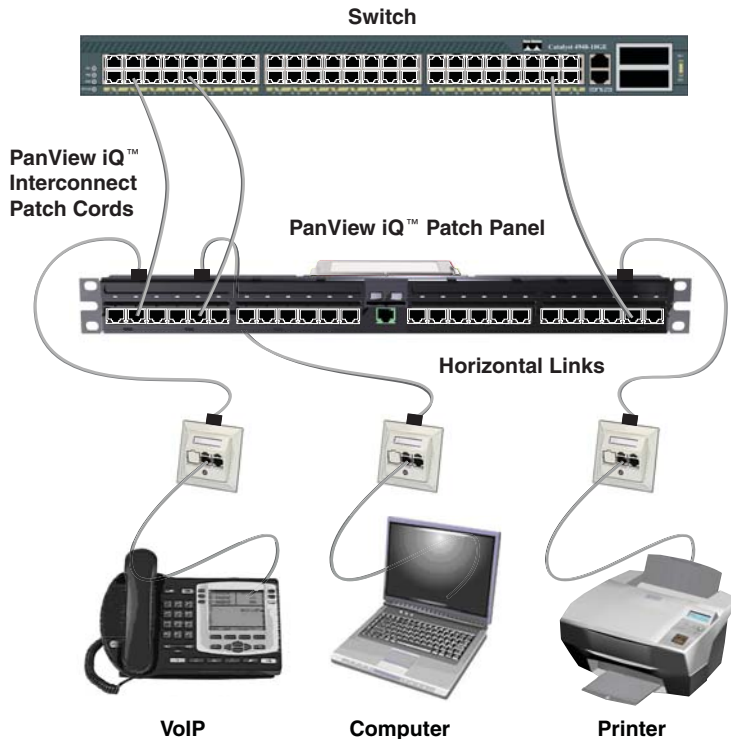

- Eliminates the need for scanner units and the rack spaces that these units occupy
- Eliminates the need for attachment cables and stick-on strips which mount to switches

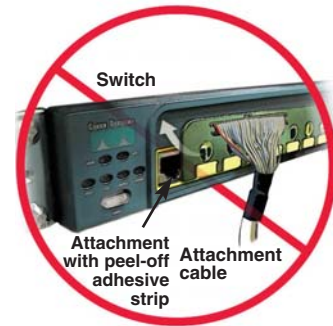

- Provisioning port allows guided patching from PanView iQ™ Patch Panel to designated switch ports
- Detects patch cord connections/disconnections made between the switch and PanView iQ™ Patch Panels

PanView iQ™ Interconnect Solution for the Data Center

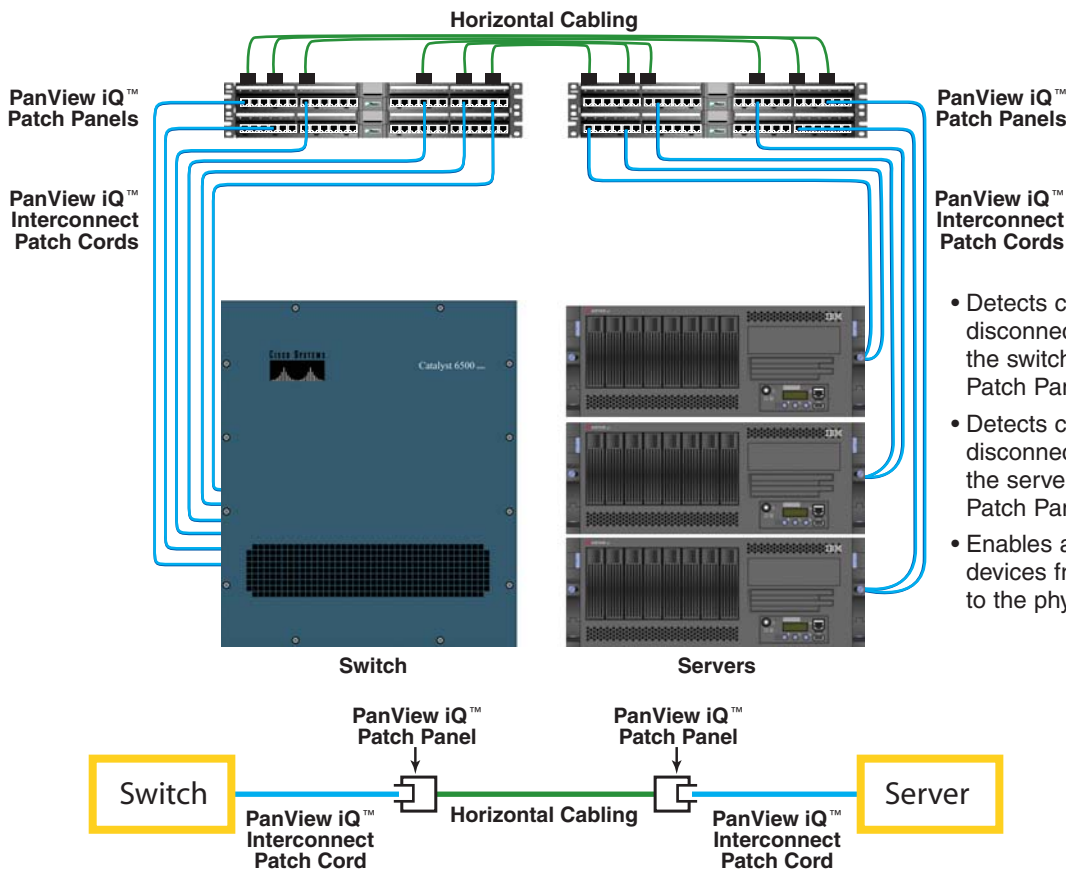

- Detects connections and disconnections made between the switch and PanView iQ™ Patch Panels
- Detects connections and disconnections made between the server and PanView iQ™ Patch Panels
- Enables asset tracking of devices from the logical layer to the physical layer



PanView iQ™ Cross-Connect Solution for the Enterprise

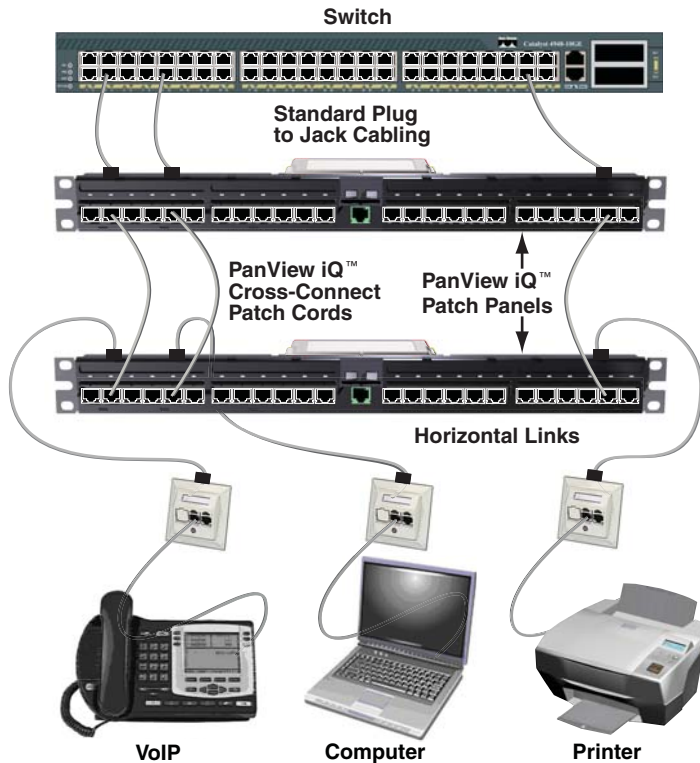

- Enables asset tracking of devices from the logical layer to the physical layer
- PanView iQ™ Patch Panels will confirm: double-ended connections (both ends connected), and single-ended connections (remote end disconnected)
- The PanView iQ™ System can automatically map the cross-connect patch field and monitor all connections for continuous security. The system also guides moves, adds, and changes

PanView iQ™ Cross-Connect Solution for the Data Center

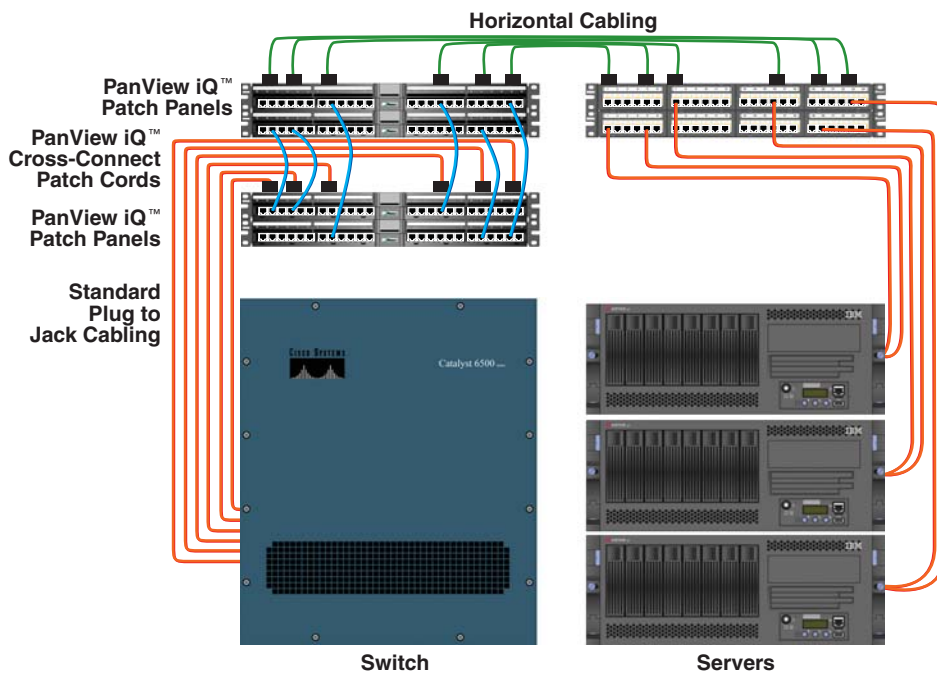

- Helps prevent damage to switch and server ports by creating protected patch field between PanView iQ™ Patch Panels. Each switch and server port is represented at the patch panel level
- PanView iQ™ Cross-Connect Patch Cords guarantee switch to server traceability to support critical moves, adds, and changes
- PanView iQ™ Patch Panels detect and send notifications of connect and disconnect status for event recording and security purposes

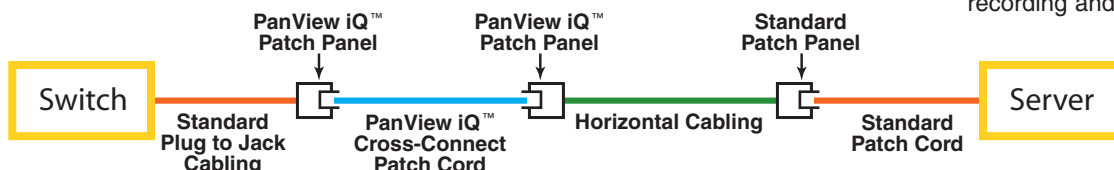

PanView iQ™ Hardware

PanView iQ™ Hardware Exploded View

PanView iQ™ Interface Unit

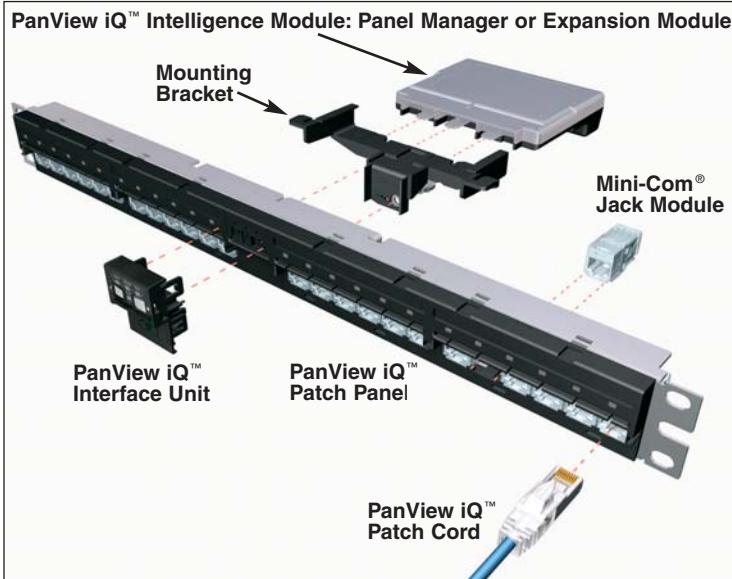

PanView iQ™ Intelligence Module is supplied with the matching interface unit.

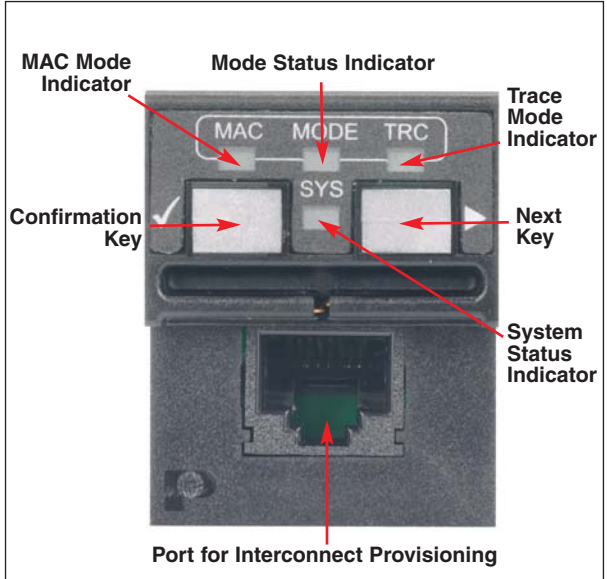

Interface unit shown for PanView iQ™ Panel Manager (PM). Interface unit for PanView iQ™ Expansion Manager (EM) does not contain provisioning port.

Recommended PanView iQ™ 96-Port Configuration (Rear View)

This recommended 96-port configuration delivers optimum efficiency and scalability for large installations.

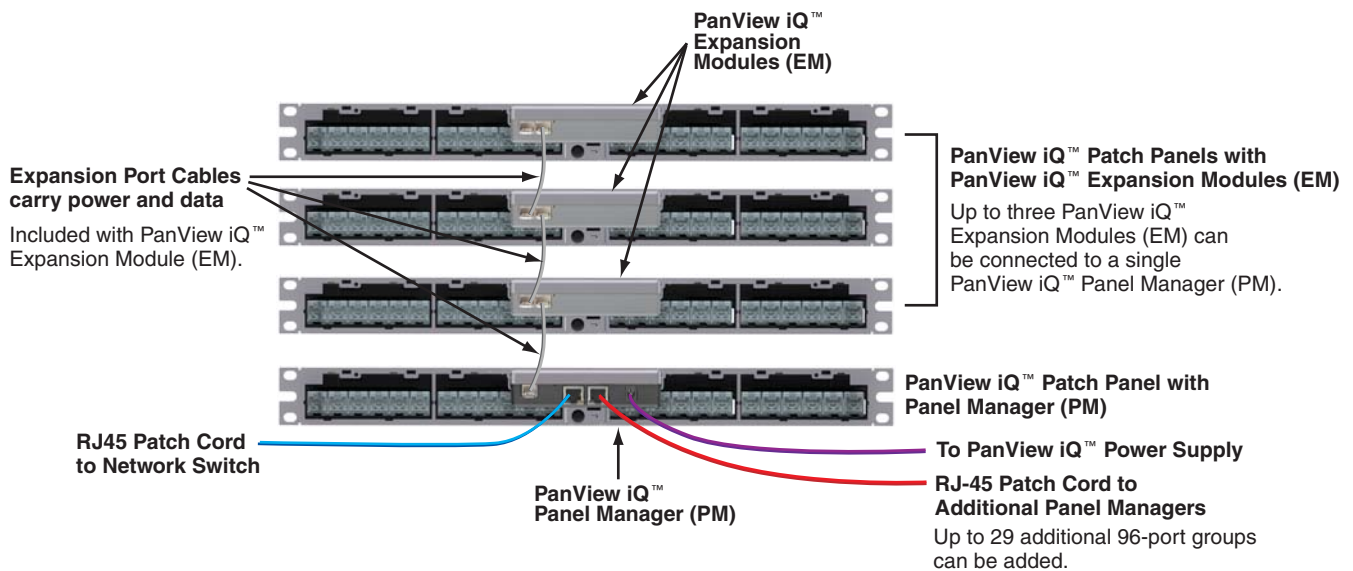

Physical Infrastructure Management System Roadmap



1 PanView iQ™ Intelligence Modules (page I.9)



2 PanView iQ™ Patch Panels (page I.7)



3 PanView iQ™ Power Supply (page I.9)



4 Power Outlet Units (page L.35 – L.55)



5 Physical Infrastructure Manager™ Software Platform (page I.6)



6 PanView iQ™ Copper and Fiber Patch Cords (pages I.10 and I.11)



7 Horizontal Cable Managers (page L.76)



8 Ultimate ID® Labels (pages O.11 and O.21)



Physical Infrastructure Manager™ (PIM™) Software Platform



- Supports the PanView iQ™ System
- Documents and assigns moves, adds, and changes for planned configuration changes
- Provides automated documentation of network patch field connectivity
- Utilizes a web-based graphical user interface that is globally accessible
- Provides real-time notification of all changes in physical layer patch field

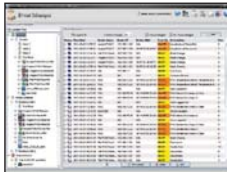

Part Number	Part Description	Std. Pkg. Qty.
PIM-MEDIA	Physical Infrastructure Manager™ Software, support tools, and documentation.	1
PIM-BASE	Base module of the PIM™ Software Solution.	1
PIM-CAMA	Comprehensive annual maintenance agreement covering both PIM™ Software Platform and PViQ™ System Hardware.	1
PIM-ASSET*	Asset tracking and utilization module of the PIM™ Software Solution.	1
PIM-POWER*	Power outlet unit monitoring module of the PIM™ Software Solution.	1
PIM-ENT	Enterprise connectivity management module of the PIM™ Software Solution.	1
PIM-CONNECT*	Connectivity module of the PIM™ Software Solution.	1
PIM-DASHBOARD*	Dashboards and reports module of the PIM™ Software Solution.‡	1
PIM-IBMINT*	IBM^ Tivoli connector module of the PIM™ Software Solution.	1
PIM-MSFTINT*	Microsoft^^ System Center Operations Manager 2007 Management Pack for the PIM™ Software Solution.	1
PIM-AYAIN*	AyaNova** work order integration module of the PIM™ Software Solution.	1
PIM-BMCINT*	BMC Remedy*** work order integration module of the PIM™ Software Solution.	1

Always check with a sales representative for latest software updates.

*To order this module, add the appropriate letter to the end of the part number, based on the size of the installation: -S (<50 racks); -M (50-199 racks); -L (200-399 racks); -X (400+ racks). For example, the part number for the Connectivity Management Module for 250 racks is PIM-CONNECT-L.

^IBM and Tivoli are registered trademarks of IBM Corporation.

^^Microsoft is a registered trademark of Microsoft Corporation.

**AyaNova is a registered trademark of Ground Zero Tech-Works.

***BMC is a registered trademark of BMC Software, Inc.

‡Advanced Dashboard and Reports Module is powered by Pentaho.

PanView iQ™ Patch Panels

PanView iQ™ Patch Panels revolutionize intelligent physical infrastructure management by providing a modular and scalable approach to meet the demands of enterprise and data center installations. Standard copper and fiber cabling is used for all terminations onto the back of these panels while unique PanView iQ™ Patch Cords are used for cross-connect or interconnect installations.

- Mount to standard EIA 19" rack or 23" racks with optional extender bracket
- Accommodates intelligent modules that mount in the rear and utilize no additional rack space (zero RU)
- Accepts all Mini-Com® UTP and STP Modules
- Accepts a PanView iQ™ Interface Unit to provide patch cord tracing and provisioning of switch ports with PanView iQ™ Interconnect Patch Cords or patch field mapping with PanView iQ™ Cross-Connect Patch Cords



PVQ-MIQAPU24



PVQ-MIQAPS24



PVQ-MIQPU24



PVQ-MIQPS24



PVQ-MIQPS96F



PVQ-MIQPS96A



PVQ-MIQAPCVR

Part Number	Part Description	No. of Rack Spaces [^]	Std. Pkg. Qty.	Std. Ctn. Qty.
Angled PanView iQ™ Patch Panels				
PVQ-MIQAPU24	24-port unpopulated angled UTP modular intelligent module-ready patch panel. Accepts all Mini-Com® UTP and LC Fiber Optic Modules.	1	1	10
PVQ-MIQAPS24	24-port unpopulated angled STP modular intelligent module-ready patch panel. Accepts all Mini-Com® STP Modules. Accepts all Mini-Com® STP Modules.	1	1	10
Flat PanView iQ™ Patch Panels				
PVQ-MIQPU24	24-port unpopulated UTP modular intelligent module-ready patch panel.	1	1	10
PVQ-MIQPS24	24-port unpopulated STP modular intelligent module-ready patch panel.	1	1	10
PanView iQ™ Hardware Kits				
PVQ-MIQPS96F	For standard configurations, this 96-port modular intelligent panel kit includes four flat PanView iQ™ Patch Panels (PVQ-MIQPU24), one PanView iQ™ Panel Manager with interface unit, and three PanView iQ™ Expansion Modules with expansion port cables and interface units. Also includes one 1.5' (0.5m) RJ45 patch cord for connection to network switch or additional daisy-chained PanView iQ™ Panel Managers. (Power supply, PanView iQ™ Patch Cords and Mini-Com® Jack Modules are not included and must be purchased separately.)	4	1	—
PVQ-MIQPS96A	For standard configurations, this 96-port modular intelligent panel kit includes four angled PanView iQ™ Patch Panels (PVQ-MIQAPU24), one PanView iQ™ Panel Manager with interface unit, and three PanView iQ™ Expansion Modules with expansion port cables and interface units. Also includes one 1.5' (0.5m) RJ45 patch cord for connection to network switch or additional daisy-chained PanView iQ™ Panel Managers. (Power supply, PanView iQ™ Patch Cords and Mini-Com® Jack Modules are not included and must be purchased separately.)	4	1	—
PanView iQ™ Patch Panel Accessories				
PVQ-MIQAPCVR	Transitional cover for angled PVIQ patch panels that occupies zero rack space.	0	1	—

[^]One rack space = 1.75" (44.45mm).

PanView iQ™ Panel Manager requires proper country-specific power supply (PVQ-PS12VDC-S for North America, PVQ-PS12VDC-E for Europe, PVQ-PS12VDC-J for Japan, PVQ-PS12VDC-C for China, or PVQ-PS12VDC-U for United Kingdom) which must be ordered separately, found on page I.9.

Component Labels for PanView iQ™ Patch Panels



Suggested Label Solutions for TIA/EIA-606-A Compliance

Patch Panel Part Number	Laser/Ink Jet Desktop Printer Label	PanTher™ LS8E Hand-Held Printer Label	Cougar™ LS9 Hand-Held Printer Label
All Patch Panels on Page I.7	UILJ6	UILS8BW	UILS8BW

For complete Ultimate ID® Labeling Solutions and product information, reference charts on pages O.11 and O.21.

PanView iQ™ Fiber Trays

- Provides real-time physical layer management to the fiber channels in the network
- Enhances usability and maintainability through an enclosure and drawer design that allows for easy access to the fiber connectivity
- An easily-accessible integrated mechanism for mounting a PM or EM module simplifies installation and maintenance
- Provides the capability to map and monitor the fiber channels to efficiently manage resources and substantially reduce network operations cost
- Provides the capability to automate network documentation and maintenance procedures for the physical layer, which in turn supports improved reliability, security, and increased overall network management efficiency
- Installable in a 19" standard TIA/EIA rack or cabinet utilizing 1RU of space



PVQ-FMT

Part Number	Part Description	No. of Rack Spaces [^]	Std. Pkg. Qty.	Std. Ctn. Qty.
PVQ-FMT	24-port PanView iQ™ Fiber Tray with no fiber adapters.	1	1	1
PVQ-FMTMTP-ZX	PViQ™ 24-Port OM3 MTP Fiber Tray including 24 (CMDSAQLCZBL) LC SR./SR. 10Gig™ SFF Duplex Multimode Aqua Adapters with Zirconia Ceramic Split Sleeves.	1	1	1
PVQ-FMTMTP-ZZ	PViQ™ 24-Port OM4 MTP Fiber Tray including 24 (CMDSAQLCZBL) LC SR./SR. 10Gig™ SFF Duplex Multimode Aqua Adapters with Zirconia Ceramic Split Sleeves.	1	1	1
PVQ-FMTMTP-9	PViQ™ 24-Port, Single-Mode Fiber Tray including 24 (CMDSLCZBU) LC SR./SR. SFF Duplex Singlemode Blue Adapters with Zirconia Ceramic Split Sleeves.	1	1	1

[^]One rack space = 1.75" (44.45mm).

PanView iQ™ Intelligence Modules

PanView iQ™ Intelligence Modules enable the PanView iQ™ Patch Panels to sense connections and disconnections from each port and relay status information to the Physical Infrastructure Manager™ (PIM) database. The intelligence modules also accept trace mode and MAC commands to provide guidance via the PanView iQ™ Interface Unit and Patch Panel LEDs.

- Provides manageability for a PanView iQ™ Patch Panel
- Eliminates the need for additional rack space by attaching directly to the back of a PanView iQ™ Patch Panel
- Enables quick addition, removal, or replacement of intelligence modules to add management capabilities
- Supports both cross-connect or interconnect installations
- The panel manager (PM) module provides networking interface, power connection and expansion port connections
- The expansion module (EM) receives all power and data signals from the PM through the expansion port; three EMs can be connected to one PM
- Support PanView iQ™ Hardware
- Optional Expansion Port Cables allow connection through various mounting options; for example, PVQ-EPC28 is designed to be utilized when installing PViQ patch panels in a zero RU (vertical mounting) configuration



Part Number	Part Description	Std. Pkg. Qty.
PVQ-PM	Panel manager (includes mounting bracket, 1.5' (0.5m) RJ45 patch cord, and interface unit).	1
PVQ-EM	Expansion module (includes mounting bracket, 7" expansion port cable, and interface unit).	1
PVQ-EPC14*	PanView iQ™ Expansion Port Cable, 14", (0.36m).	1

*For lengths of 20, 28, 35 or 43 inches, change the 14 in the part number to the desired length. PanView iQ™ Panel Manager requires proper country-specific power supply (PVQ-PS12VDC-S for North America, PVQ-PS12VDC-E for Europe, PVQ-PS12VDC-J for Japan, PVQ-PS12VDC-C for China, or PVQ-PS12VDC-U for United Kingdom) which must be ordered separately.

PanView iQ™ Power Supply

- Provides 12 volts of regulated power
- One power supply required per panel manager module
- Offers flexible placement inside of rack
- 5 feet (1.5m) cord length



Part Number	Part Description	Std. Pkg. Qty.
PVQ-PS12VDC-S	30W power supply for North America.	1
PVQ-PS12VDC-E	30W power supply for Europe.	1
PVQ-PS12VDC-U	30W power supply for UK.	1
PVQ-PS12VDC-J	30W power supply for Japan.	1
PVQ-PS12VDC-C	30W power supply for China.	1

PanView iQ™ Patch Cords

- PanView iQ™ Interconnect Patch Cords support connectivity between shielded non-PanView iQ™ enabled ports (e.g., switches with shielded jacks, servers with shielded jacks, etc.) and PanView iQ™ Panel Ports
- PanView iQ™ Cross-Connect Patch Cords manage and map the patch field between two PanView iQ™ Patch Panels
- All PanView iQ™ Patch Cords permit PanView iQ™ Panels to detect single-ended connections

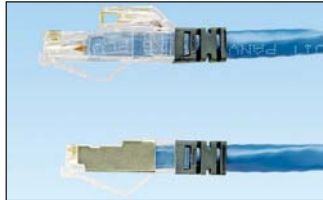
**PVQ-BIU6C3BU**

Part Number	Part Description	Length		Cable Color	Std. Pkg. Qty.	Std. Ctn. Qty.
		Ft.	m			
Copper Interconnect Patch Cords – Basic						
PVQ-BIU6C3BU*	Category 6 UTP interconnect patch cord for use with PanView iQ™ patch panel, Communications (CM) rated.	3	—	Blue	1	10
PVQ-BIU6C1MBU^	Category 6 UTP interconnect patch cord for use with PanView iQ™ patch panel, Communications (CM) rated.	—	1	Blue	1	10
PVQ-BIU6L1MBU^	Category 6 UTP interconnect patch cord for use with PanView iQ™ patch panel, Low Smoke Zero Halogen (LSZH) rated.	—	1	Blue	1	10

Additional lengths and colors available:

*For lengths of 5, 7, 10, 14, or 20 feet, change the length designation in the part number to the desired length. For standard cable color other than BU (Blue), replace BU in the part number with GR (Green). For example, the part number for a green, 5-foot patch cord is PVQ-BIU6C5GR.

^For lengths of 2, 3, 5, or 10 meters, change the length designation in the part number to the desired length. For standard cable color other than BU (Blue), replace BU with WH (White). For example, the part number for a white 2-meter patch cord is PVQ-BIU6L2MWH.

Contact Panduit Customer Service for lead times and for non-standard lengths and colors.

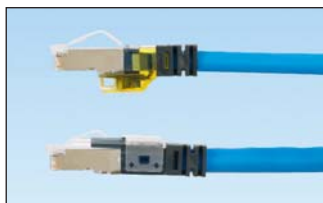
**PVQ-ES6X3BU**

Part Number	Part Description	Length		Cable Color	Std. Pkg. Qty.	Std. Ctn. Qty.
		Ft.	m			
Copper Interconnect Patch Cords – Enhanced						
PVQ-EU6AC3BU*	10Gig™ UTP Enhanced Interconnect Patch Cord for use with PanView iQ™ Patch Panel, Communications (CM rated).	3	—	Blue	1	10
PVQ-EU6AC1MBU^	10Gig™ UTP Enhanced Interconnect Patch Cord for use with PanView iQ™ Patch Panel, Communications (CM rated).	—	1	Blue	1	10
PVQ-ES6X3BU*	10Gig™ STP Enhanced Interconnect Patch Cord for use with PanView iQ™ Patch Panel, dual rated.	3	—	Blue	1	10
PVQ-ES6X1MBU^	10Gig™ STP Enhanced Interconnect Patch Cord for use with PanView iQ™ Patch Panel, dual rated.	—	1	Blue	1	10

Additional lengths and colors available:

*For lengths of 5, 7, 10, 14, or 20 feet, change the length designation in the part number to the desired length. For standard cable color other than BU (Blue), replace BU in the part number with WH (White). For example, the part number for a white, 5-foot patch cord is PVQ-EU6AC5WH.

^For lengths of 2, 3, 5, or 10 meters, change the length designation in the part number to the desired length. For standard cable color other than BU (Blue), replace BU with WH (White). For example, the part number for a white 2-meter patch cord is PVQ-ES6X2MWH.

Contact Panduit Customer Service for lead times and for non-standard lengths and colors.

PanView iQ™ Patch Cords (continued)



PVQXPE10LQM

Part Number	Part Description	Length [^]		Std. Pkg. Qty.	Std. Ctn. Qty.
		Ft.	m		
Fiber Interconnect Patch Cords					
PVQXPE10LQM00.5	PanView iQ duplex LC to duplex standard LC, OM3, fiber interconnect patch cord, plenum rated, 1.6mm jacketed cable.	—	0.5	1	10
PVQZPE10LQM00.5	PanView iQ duplex LC to duplex standard LC, OM4, fiber interconnect patch cord, plenum rated, 1.6mm jacketed cable.	—	0.5	1	10
PVQ9PE10LQM00.5	PanView iQ duplex LC to duplex standard LC, OS1/OS2, fiber interconnect patch cord, plenum rated, 1.6mm jacketed cable.	—	0.5	1	10

[^]Available in lengths up to 10 meters, in 1/2-meter increments. To order another length, replace 0.5 with desired length.



PVUTPSPC*BBUY

Part Number	Part Description	Length [^]		Std. Pkg. Qty.	Std. Ctn. Qty.
		Ft.	m		
Cross-Connect Patch Cords					
PVUTPSPC3BBUY	Category 6 UTP patch cord for use with modular patch panel.	3	—	1	10
PVUTPSPC1MBBUY	Category 6 UTP patch cord for use with modular patch panel.	—	1	1	10
PVSTP6X1MBBU	Category 6A, STP modular 10Gig™ Patch Cord.	—	1	1	10
PVUTP6X1MBBU	Category 6A, UTP modular 10Gig™ Patch Cord.	—	1	1	10
PVF9L10-10M0.5Y	Singlemode LSZH LC-LC patch cord.	—	1	1	10
PVFXL10-10M0.5Y	Multimode LSZH OM3 LC-LC patch cord.	—	1	1	10

[^]Additional lengths available: PVUTPSPC3BBUY also available in lengths of 5, 7, 9, 14, and 20 feet. PVUTPSPC1MBBUY also available in lengths of 2, 3, 5, and 10 meters. PVSTP6X1MBBU also available in lengths of 2, 3, 5, and 10 meters. PVF9L10-10M0.5Y and PVFXL10-10M0.5Y also available in 1/2-meter increments up to 10 meters.

Contact Panduit Customer Service for lead times.

Consult www.panduit.com/pim for additional colors and lengths available.



PVSTP6X*MBBU



PVF9L10-10M*Y

Labels for PanView iQ™ Patch Cords

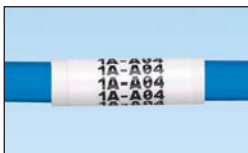

Patch Cord Part Number	Suggested Label Solutions for TIA/EIA-606-A Compliance			
	Laser/Ink Jet Desktop Printer Label	TDP43ME Thermal Transfer Desktop Printer Label	PanTher™ LS8E Hand-Held Printer Label	Cougar™ LS9 Hand-Held Printer Label
All Patch Cords on Page I.10 and I.11	S100X150YAJ	S100X150VATY	S100X150VAC	T100X000CBC-BK

For complete labeling solutions and product information, reference charts on pages O.1 – O.25.

NOTES

FIBERRUNNER® ROUTING SYSTEMS

Panduit provides innovative solutions for routing fiber optic and high performance copper cabling to and between equipment racks within a data center, telecommunications room, or service provider facility. Routing products such as the FiberRunner® Routing System are critical factors in your ability to quickly install, easily implement moves, adds, and changes, and maintain the integrity of your fiber and copper cabling plant in order to maximize long-term performance.

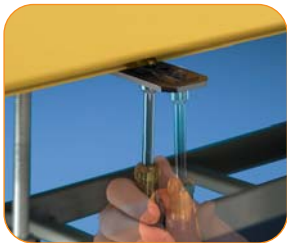

- Robust, large capacity 24x4, 12x4, and 6x4 systems to handle large cable counts; 4x4 and 2x2 systems for use with smaller cable counts
- Hinged channel cover and split fitting covers for 12x4, 6x4, and 4x4 systems protect cabling and provide easy access for future cabling revisions and additions
- QuikLock™ assembly features eliminate or minimize the need for tools to assemble the system; QuikLock™ Couplers and Brackets require less than five seconds to mechanically secure components
- 12x4, 6x4, 4x4, and 2x2 fittings provide minimum 2" (50.8mm) bend radius and 24x4 fittings provide 3" (76.2mm) bend radius to protect against signal loss due to excessive cable bends
- Multiple spillout options provide versatility to make transitions to various equipment and rack configurations
- Compatible with Panduit® Fiber-Duct™ 4x4 and 2x2 Routing Systems, CabRunner® and Wyr-Grid® Overhead Routing Systems, cable management, and racks

The FiberRunner® 24x4, 12x4, 6x4, 4x4, and 2x2 Routing Systems are comprised of channel, couplers, fittings, and brackets designed to segregate, route, and protect fiber optic and high performance copper cabling.

As part of the Panduit Data Center Solution, FiberRunner® Routing Systems offers secure, reliable system integration and risk management within the physical infrastructure.

24x4 Routing System Roadmap

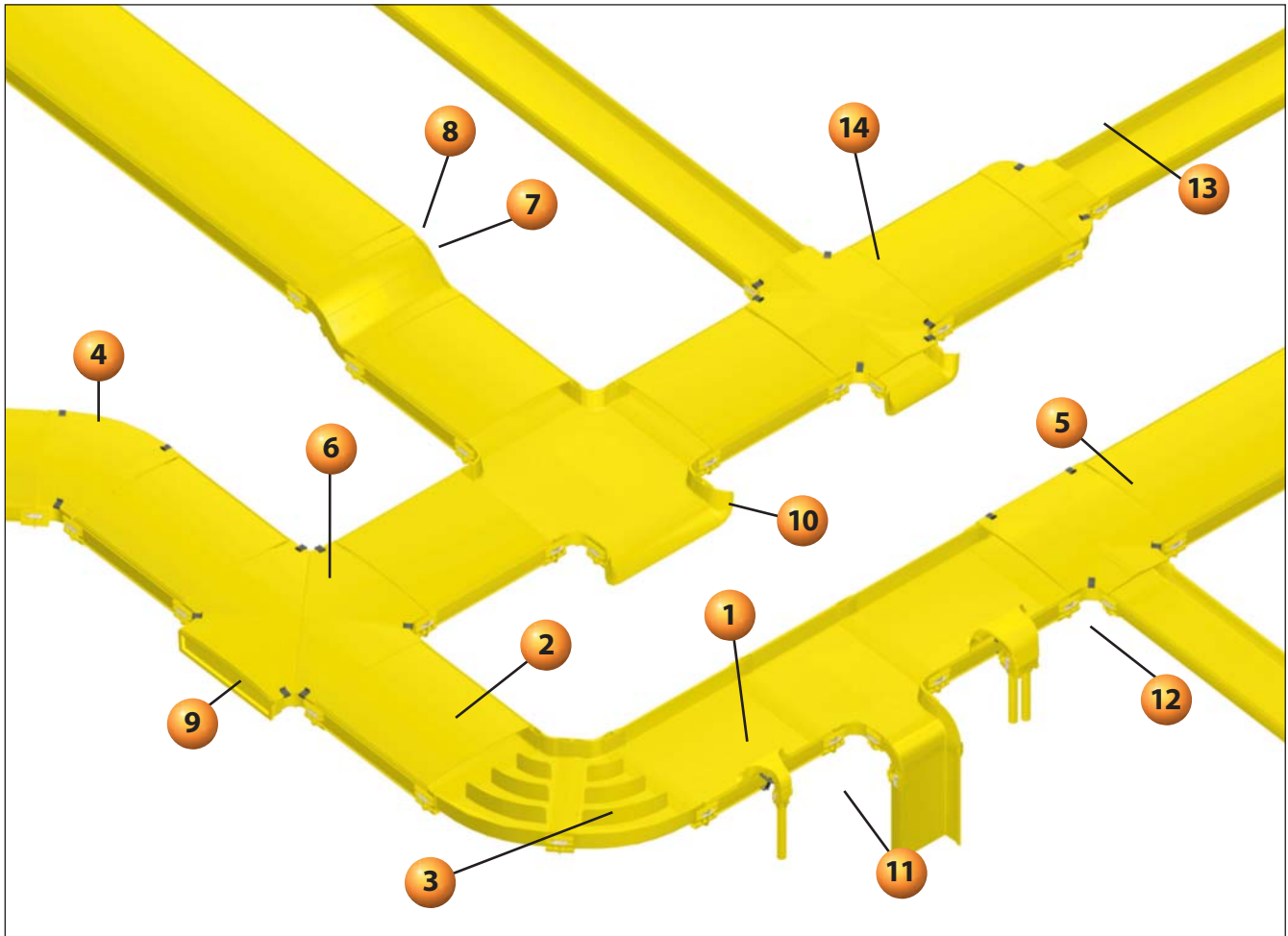

24x4 FiberRunner® Mounting Brackets

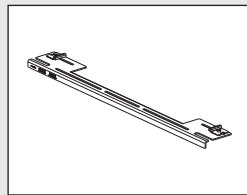

FR24TBE12 - Existing Threaded Rod QuikLock™ Bracket (page J.9)

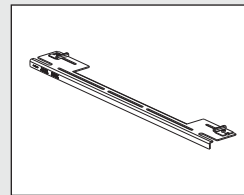

FR24TBN12 - New Threaded Rod QuikLock™ Bracket (page J.9)

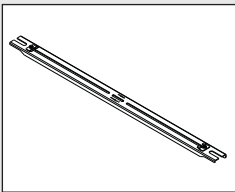

FRTBWG30BL - Wyr-Grid® Mounting Bracket for FiberRunner® System (page J.9)

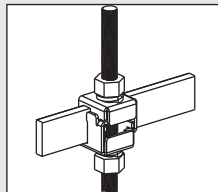

F2PCLB12 - Two-Piece Ladder Rack Bracket for Attaching Threaded Rod to 1 1/2" - 2" Ladder Rack (page J.9)

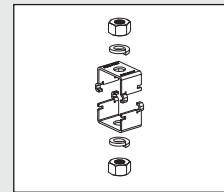

FRAFC58 - Two Piece Framing Clip for Attaching 5/8" Threaded Rod to 2" x 9/16" C-Channel Auxiliary Framing Bars (page J.9)

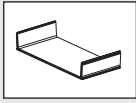

- 1** FR24X4**10 – 24x4 FiberRunner® Channel (page J.4)

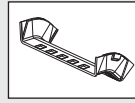

- 8** FROV4524X4** – 24x4 Outside Vertical 45° Angle Fitting and FROV45CV24** – Optional Cover (page J.6)

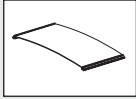

- 2** FRCV24**10 – 24x4 Snap-On Cover (page J.4)

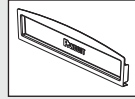

- 9** FREC24X4** – 24x4 End Cap Fitting (page J.5)

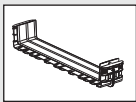

- 3** FRBC24X4** – 24x4 QuikLock™ Coupler (page J.4)

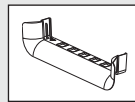

- 10** FRTR24X4** – 3-Sided BRC Trumpet Spillout for 24x4 Exit (page J.8)

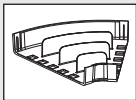

- 4** FRH4524X4** – 24x4 Horizontal 45° Angle Fitting and FRH45CV24** – Optional Cover (page J.5)

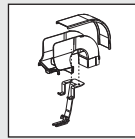

- 11** FRSPJ2X2** – Spill-Over Junction with 2x2 Exit (page J.7)

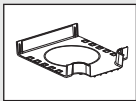

- 5** FRT24X4W12** – 24x4 Horizontal Tee with 12x4 Exit and FRTC24W12** – Optional Cover (page J.5)

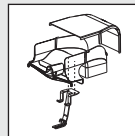

- 12** FRSPJ4X4** – Spill-Over Junction with 4x4 Exit (page J.8)

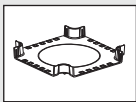

- 6** FRFWC24X4** – 24x4 4-Way Cross Fitting and FRFWCCV24** – Optional Cover (page J.5)

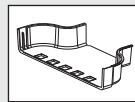

- 13** FRRF2412** – 24x4 to 12x4 FiberRunner® Reducer Fitting and FRRF2412CV** – Optional Cover (page J.6)

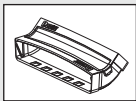

- 7** FRIV4524X4** – 24x4 Inside Vertical 45° Angle Fitting (page J.6)

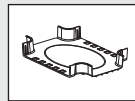

- 14** FRFWC24X4W12** – 24x4 4-Way Cross Fitting with 12x4 Exits and FRFWCCV24W12** – Optional Cover (page J.5)

**Available colors include: YL (Yellow), OR (Orange), and BL (Black).

24x4 FiberRunner[®] Routing System

Cable Fills for 24x4 FiberRunner[®] Routing System

The maximum amounts may vary according to the cable fill installation methods, straightness of cables, etc.

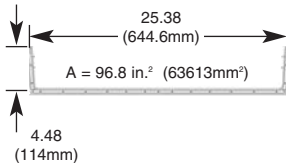

24x4 FiberRunner [®] Cable Routing System								
Fill/Pile Up	Internal Area (in ²)	Diameter 1.6mm 0.063"	Diameter 2.0mm 0.079"	Diameter 3.0mm 0.118"	Fiber Optic Ribbon Interconnect Cable Diameter 5.20mm 0.205"	Category 6A (SD) Diameter 6.1mm 0.240"	Category 6A Diameter 7.6mm 0.300"	Category 6 Diameter 6.1mm 0.240"
40% Fill								
2" Pile Up	48.1	6174	3951	1756	583	425	272	425
3" Pile Up	72.4	9293	5947	2643	877	640	410	640
4" Pile Up	98.6	12656	8099	3600	1195	872	558	872
50% Fill								
2" Pile Up	48.1	7718	4939	2195	729	532	340	532
3" Pile Up	72.4	11616	7434	3304	1097	800	512	800
4" Pile Up	98.6	15820	10124	4500	1494	1090	697	1090
60% Fill								
2" Pile Up	48.1	9261	5927	2634	874	638	408	638
3" Pile Up	72.4	13940	8921	3965	1316	960	615	960
4" Pile Up	98.6	18984	12149	5400	1792	1308	837	1308

Channel cutting instructions: For optimum results, use a miter box and saw. For larger quantities use a plastic cutting saw blade for clean, burr-free cuts. Recommend: Carbide 80T and 100T; .090" thickness, .125" kerf.

The above cable diameters represent the nominal Panduit cable diameter per performance level. For specific cable fill information based on specific part numbers, please contact Panduit customer service.

24x4 FiberRunner[®] Routing System – Channel and Cover

- Robust, large capacity 24x4 system ideal for use with large cable counts
- QuikLock[™] Couplers and Brackets reduce system installation time dramatically
- Channel, covers, fittings and other non-metallic system components made from V-0 flame class rated material
- Compatible with all sizes of Panduit[®] FiberRunner[®] and Routing Systems, cable management, and racks



FR24X4



FRCV24

Part Number	Part Description	Std. Pkg. Qty.	Std. Ctn. Qty.
FR24X4YL10	Used to carry cables horizontally throughout the system. Use QuikLock [™] Coupler FRBC24X4YL to attach channel and/or fittings.	10	20

24x4 Snap-On Cover

FRCV24YL10	Optional snap-on cover for channel FR24X4YL10. Supplied in four 30" long pieces.	10	—
-------------------	--	----	---

For other colors replace YL (Yellow) with OR (Orange) or BL (Black).
Order number of feet required, in multiples of standard 10' length increments.

24x4 FiberRunner[®] QuikLock[™] Coupler

- Pre-assembled to provide fast mechanical assembly of components
- No tools required for installation; bolts loosen for component disassembly
- For other standard colors replace suffix YL (Yellow) with OR (Orange) or BL (Black)

Part Number	Part Description	Std. Pkg. Qty.	Std. Ctn. Qty.
FRBC24X4YL	Pre-assembled coupler quickly joins two sections of channel and/or fittings. Mechanically attaches without tightening bolts. Bolts release using 3/8" nut driver to allow coupler to be removed if necessary.	1	5

For other colors replace suffix YL (Yellow) with OR (Orange) or BL (Black).



24x4 FiberRunner® System Fittings

- Minimum 3" (76.2mm) bend radius control fittings
- Assemble using FRBC QuikLock™ Couplers
- Protect against signal loss and performance degradation



FRH4524X4



FRH45CV24



FRT24X4W12



FRTC24W12



FRFWC24X4



FRFWCC24



FRFWC24X4W12



FRFWCC24W12



FREC24X4

Part Number	Part Description	Couplers Required	Std. Pkg. Qty.	Std. Ctn. Qty.
24x4 Horizontal 45° Angle Fitting				
FRH4524X4YL	Attaches to 24x4 channel and/or fittings to create a 45° horizontal turn from a straight horizontal run.	(2 pcs.) FRBC24X4YL	1	—
Cover for 24x4 Horizontal 45° Angle Fitting				
FRH45CV24YL	Optional cover for the horizontal 45° angle fitting FRH4524X4YL. Snap-on feature allows cover to be installed and removed with no tools required.	—	1	—
24x4 Horizontal Tee with 12x4 Exit				
FRT24X4W12YL	Attaches to 24x4 channel and/or fittings to create a 90° horizontal branch with a 12x4 exit from straight horizontal run. Accepts optional split cover FRTC24W12YL.	(2 pcs.) FRBC24X4YL (1 pc.) FRBC12X4YL	1	—
Cover for 24x4 Horizontal Tee with 12x4 Exit				
FRTC24W12YL	Optional cover for the horizontal tee fitting FRT24X4W12YL. Snap-on feature allows cover to be installed and removed with no tools required.	—	1	—
24x4 Four-Way Cross Fitting				
FRFWC24X4YL	Attaches to 24x4 channel and/or fittings to create a horizontal four way cross intersection with two 24x4 exits. Accepts optional split cover FRFWCC24YL.	(4 pcs.) FRBC24X4YL	1	—
24x4 FiberRunner® Four-Way Cross Cover				
FRFWCC24YL	Optional cover for the four way cross fitting FRFWC24X4YL. Snap-on feature allows cover to be installed and removed with no tools required.	—	1	—
24x4 Four-Way Cross Fitting with 12x4 exits				
FRFWC24X4W12YL	Attaches to a 24x4 channel and/or fittings to create a horizontal four way cross intersection with two 12x4 exits. Accepts optional split cover FRFWCC24W12YL.	(2 pcs.) FRBC24X4YL (2 pcs.) FRBC12X4YL	1	—
Cover for 24x4 Four-Way Cross Fitting with 12x4 Exits				
FRFWCC24W12YL	Optional cover for the four way cross fitting FRFWC24X4W12YL. Cover can be installed and removed with no tools required.	—	1	—
24x4 End Cap Fitting				
FREC24X4YL	Used for closing off open ends of the channel or fittings. No coupler required. Push-on installation.	—	1	5

For other colors replace suffix YL (Yellow) with OR (Orange) or BL (Black).

Table continues on page J.6

24x4 FiberRunner[®] System Fittings (continued)**FRIV4524X4****FROV4524X4****FROV45CV24****FRRF2412****FRRF2412CV**

Part Number	Part Description	Couplers Required	Std. Pkg. Qty.	Std. Ctn. Qty.
24x4 Inside Vertical 45° Fitting and Cover				
FRIV4524X4YL	Attaches to 24x4 channel and/or fittings to create a 45° upward angle from a straight horizontal run. Used with outside vertical 45° angle fitting FROV4524X4YL to change level of a straight horizontal run. Includes cover.	(2 pcs.) FRBC24X4YL	1	—
24x4 Outside Vertical 45° Fitting				
FROV4524X4YL	Attaches to 24x4 channel and/or fittings to create a 45° downward angle from a straight horizontal run. Used with inside vertical 45° angle fitting FRIV4524X4YL to change level of a horizontal run.	(2 pcs.) FRBC24X4YL	1	—
Cover for 24x4 Outside Vertical 45° Angle Fitting				
FROV45CV24YL	Optional cover for the outside vertical 45° angle fitting FROV4524X4YL. Snap-on feature allows cover to be installed and removed with no tools required.	—	1	—
Reducer from 24x4 FiberRunner[®] to 12x4 FiberRunner[®]				
FRRF2412YL	Attaches any 24x4 FiberRunner [®] Fitting or Channel to any 12x4 FiberRunner [®] Fitting or Channel.	(1 pc.) FRBC24X4YL (1 pc.) FRBC12X4YL	1	—
Cover for 24x4 to 12x4 FiberRunner[®] Reducer Fitting				
FRRF2412CVYL	Optional cover for the reducer from 24x4 FiberRunner [®] to 12x4 FiberRunner [®] FRRF2412YL. Snap-on feature allows cover to be installed and removed with no tools required.	—	1	—

For other colors replace suffix YL (Yellow) with OR (Orange) or BL (Black).

24x4 FiberRunner® System Spillouts

- Spill-overs allow safe transition from horizontal to vertical runs
- 2" (50.8mm) bend radius control
- Transition to channel, slotted channel, and corrugated loom tubing
- Spill-over junction fittings can be retro-fitted to existing horizontal runs



FRSPJ2X2



FTR2X2



FIDT2X2



FRHD2KT



TRC2HDBL

Part Number	Part Description	Couplers Required	Std. Pkg. Qty.	Std. Ctn. Qty.
Spill-Over Junction with 2x2 Exit				
FRSPJ2X2YL	Assembles onto 4x4, 6x4, 12x4, or 24x4 FiberRunner® Channel, spilling over the side into a 2x2 vertical exit. Requires coupler to attach 2x2 FiberRunner® and fittings to the vertical exit. Mounts directly to existing installation with no alteration required. Mounting hardware provided for secure attachment.	(1 pc.) FBC2X2YL	1	—
3-Sided BRC Trumpet Spillout for 2x2 Exit				
FTR2X2YL	Used to limit the bend radius of the cable to 2" (50.8mm) when exiting from a spill-over junction with a 2x2 exit or from 2x2 Fiber-Duct™ Channel.	(1 pc.) FBC2X2YL	1	5
1-Port Spillout to 1.5" (38mm) Inside Diameter Corrugated Tubing				
FIDT2X2YL	Used to route cable into one piece of 1.5" (38mm) diameter split corrugated tubing. Used with a spill-over junction with a 2x2 exit, 2x2 Fiber-Duct™ Fittings, and the 2x2 FiberRunner® Hinged Channel. Securely holds split corrugated tubing to ensure system integrity and easy access to add or remove cables.	(1 pc.) FBC2X2YL	1	5
2x2 Hinged Duct Vertical Cable Manager Kit				
FRHD2KTYL	Provides secure, accessible route for cables spilling out from a vertical tee or spill-over junction to rack mounted equipment. Kit includes 6' length of 2x2 FiberRunner® Hinged Channel H2X2YL6, 6' length of 2x2 snap-on hinged cover HC2YL6, four adjustable "Z" brackets FZBA1.5X4, one FiberRunner® 2x2 End Cap FHDEC2X2YL, six hinged duct 2" wire retainers WR2H-C, and all required mounting hardware. Attaches to 2x2 vertical tee exit or spill-over junction with a 2x2 exit with a 2x2 QuikLock™ Coupler FBC2X2YL. Also attaches directly to 4x4 or 6x4 vertical tee exits with low profile reducer FRLPR42BL.	—	1	—
2x2 FiberRunner® Bend Radius Control Trumpet				
TRC2HDBL	Bend radius control trumpet for exiting at the sidewall of 2" wall heights of type H hinged cover wiring duct channels. Maintains 1" (25.4mm) bend radius control. Black color only.	—	1	10

For other colors replace suffix YL (Yellow) with OR (Orange), BL (Black), or LG (Light Gray).

24x4 FiberRunner[®] System Spillouts (continued)**FRSPJ4X4****FRTR4X4****FRIDT4X4****FRHD4KT****TRC4HDBL****FRTR24X4**

Part Number	Part Description	Couplers Required	Std. Pkg. Qty.	Std. Ctn. Qty.
Spill-Over Junction with 4x4 Exit				
FRSPJ4X4YL	Assembles onto 4x4, 6x4, 12x4, or 24x4 FiberRunner [®] Channel, spilling over the side into a 4x4 vertical exit. Requires coupler to attach 4x4 FiberRunner [®] Channel and fittings to the vertical exit. Mounts directly to existing installation with no alteration required. Mounting hardware provided for secure attachment.	(1 pc.) FRBC4X4YL	1	—
3-Sided BRC Trumpet Spillout for 4x4 FiberRunner[®] Exit				
FRTR4X4YL	Used to limit the bend radius of the cable to 2" (50.8mm) when exiting from 4x4 FiberRunner [®] Channel or a 4x4 FiberRunner [®] Horizontal Tee.	(1 pc.) FRBC4X4YL	1	5
2-Port Spillout to 1.5" (38mm) Inside Diameter Corrugated Tubing				
FRIDT4X4YL	Used to route cable into one or two pieces of 1.5" (38mm) diameter split corrugated tubing. Requires coupler to be used with 4x4 FiberRunner [®] Fitting. Used with any 4x4 FiberRunner [®] Fitting. Securely holds corrugated split tubing to ensure system integrity and easy access to add or remove cables.	(1 pc.) FRBC4X4YL	1	5
4x4 Hinged Duct Vertical Cable Manager Kit				
FRHD4KTYL	Provides secure, accessible route for cables spilling out from vertical tee to rack mounted equipment. Kit includes 6' length of 4x4 capacity hinged duct, 6' length of 4x4 hinged duct cover, one end cap for 4x4 hinged duct, three FZBA1.5X4 adjustable "Z" brackets, an adapter fitting, six WR4-C wire retainers and all required mounting hardware. Attaches directly to 6x4 and 4x4 vertical tee exit or FRLPR64 low profile reducer.	—	1	—
4x4 Hinged Duct Bend Radius Control Trumpet				
TRC4HDBL	Bend radius control trumpet for exiting at the sidewall of 4" wall heights of type H hinged cover wiring duct channels. Maintains 1" (25.4mm) bend radius control. Black color only.	—	1	10
3-Sided BRC Trumpet Spillout for 24x4 Exit				
FRTR24X4YL	Used to limit the bend radius of the cable to 3" (76.2mm) when exiting from the 24x4 channel or a 24x4 horizontal tee.	(1 pc.) FRBC24X4YL	1	5

For other colors replace suffix YL (Yellow) with OR (Orange), BL (Black), or LG (Light Gray).

24x4 FiberRunner® Mounting Brackets



FR24TBE12
FR24TBE12M

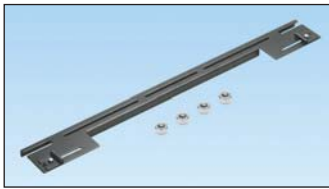

FR24TBN12
FR24TBN12M



FRTBWG30BL



F2PCLB12



FRAF58



FR12BS-L

Part Number	Part Description	For Threaded Rod Size	Std. Pkg. Qty.	Std. Ctn. Qty.
-------------	------------------	-----------------------	----------------	----------------

Existing Threaded Rod QuikLock™ Bracket for 24x4 System

FR24TBE12	Used to support the 24x4 system by spanning two 1/2" existing threaded rod drops. Can be installed from above or below. Bracket is secured to each threaded rod with two split nuts. The pre-assembled slide clamps enable fast assembly to channel. Use 7/16" nut driver on slide clamps.	1/2"	1	—
FR24TBE12M		12mm	1	—

New Threaded Rod QuikLock™ Bracket for 24x4 System

FR24TBN12	Used to support the 24x4 system from new threaded rod installations. Bracket is secured to threaded rod with two nuts. The pre-assembled slide clamps enable fast assembly to channel. Use 7/16" nut driver on slide clamps.	1/2"	1	—
FR24TBN12M		12mm	1	—

Wyr-Grid™ Mounting Bracket for FiberRunner® System

FRTBWG30BL	FiberRunner® QuikLock™ Threaded Rod Trapeze Bracket for Wyr-Grid® 30" (762mm) width. Used to support FiberRunner® 4x4, 6x4, 12x4, and 24x4 Channel above or below the Wyr-Grid® 30" Pathway using the same 1/2" or 12mm threaded rod used to support the WGTB30BL bracket. Quick mount clips, FRQMC24-X are not included for installing the 24x4 channel. These must be purchased separately. This bracket is on the same pitch as the Wyr-Grid® Bracket. Hardware for attaching to threaded rod sold separately.	1/2" 12mm	1	10
------------	---	--------------	---	----

FiberRunner® Quick Mount Clips

FRQMC24-X	Used whenever a FiberRunner® 24x4 Channel is installed on the FiberRunner® Trapeze Bracket, FRTBWG30BL for 30" Wyr-Grid™ Pathway. For use with FiberRunner® 24x4 Channel only.	—	10	50
-----------	--	---	----	----

Two-Piece Ladder Rack Bracket for Attaching Threaded Rod to 1 1/2" – 2" Ladder Rack

F2PCLB12	Two-piece bracket attaches to 3/8" (9.5mm) wide x 1 1/2" (38.1mm) or 3/8" (9.5mm) wide x 2" (50.8mm) ladder rack rail. Bracket halves slide into position and clamp together on the ladder rack rail, which allows for a one-handed assembly of the threaded rod (not included). Contains bracket and hardware for attaching bracket to ladder rack.	1/2"	1	10
----------	--	------	---	----

Two Piece Framing Clip for Attaching 5/8" Threaded Rod to 2" x 9/16" C-Channel Auxiliary Framing Bars

FRAF58	Two-piece framing clip attaches to auxiliary framing bars. Framing clip halves slide into position and interlock on the auxiliary framing bars, allowing easier assembly of the threaded rod to bars. Contains two-piece framing clip and hardware for attaching framing clip to auxiliary framing bars. (5/8" threaded rod not included.)	5/8"	1	10
--------	--	------	---	----

Self-Tapping Screws for 12x4 and 24x4 Brackets

FR12BS-L	Self-tapping screws allow selected 24x4 and 12x4 fittings to be fastened directly to mounting brackets for additional support. Screws tap directly into those 24x4 and 12x4 fittings that have plastic bosses.	—	50	500
----------	--	---	----	-----

12x4 Routing System Roadmap

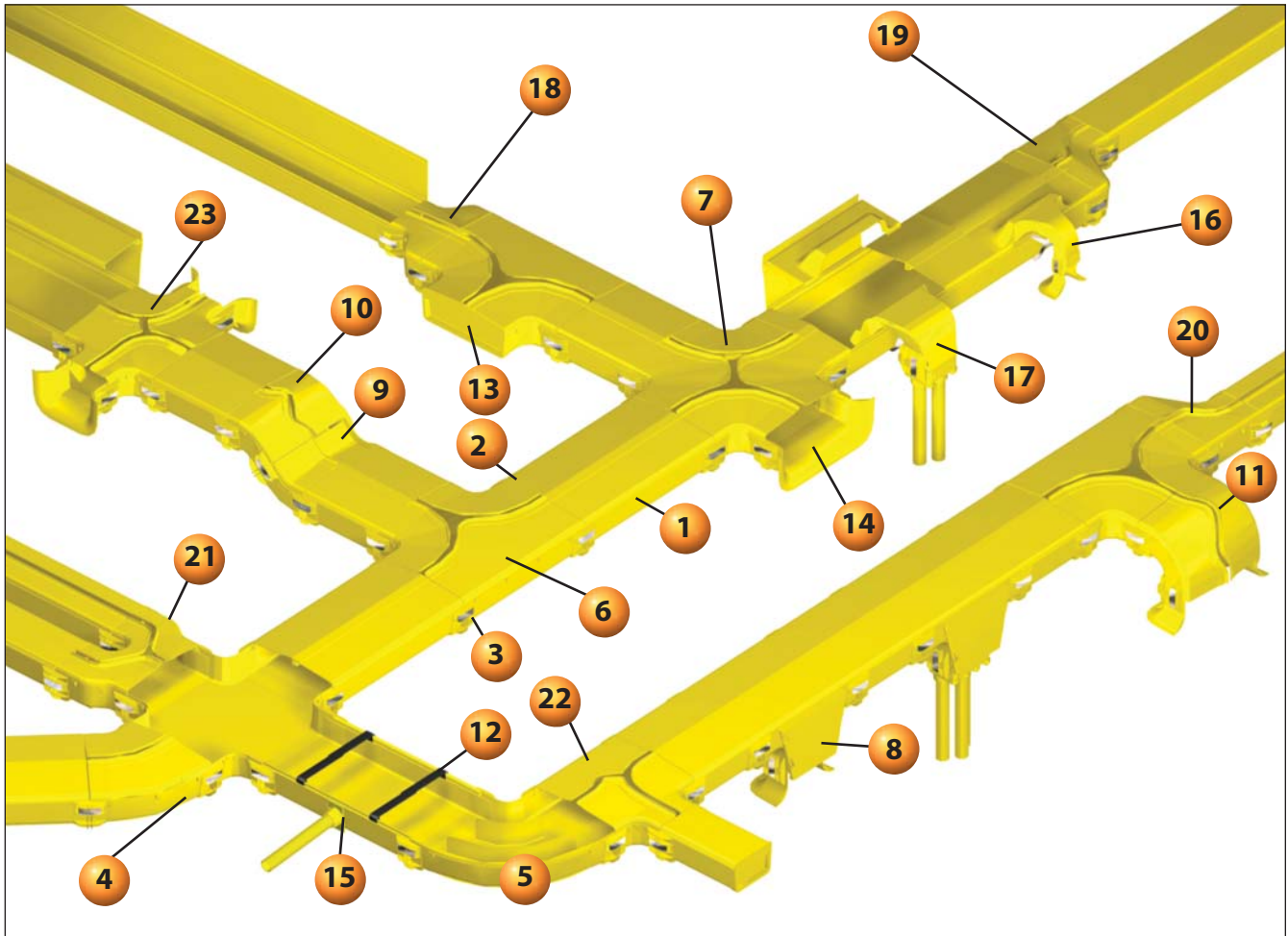

12x4 FiberRunner® Mounting Brackets

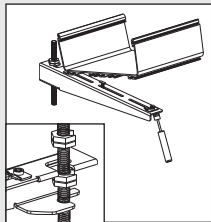

FR12TRBE58 – Existing Threaded Rod QuikLock™ Bracket (page J.20)

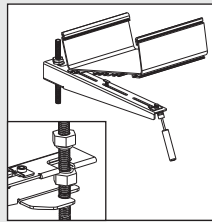

FR12TRBN58 – New Threaded Rod QuikLock™ Bracket (page J.20)

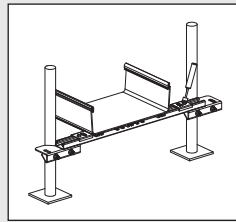

FR12USB – Underfloor Pedestal QuikLock™ Bracket (page J.20)

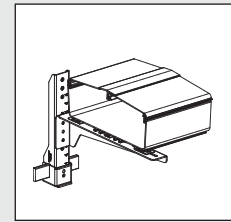

FR12ALB – Adjustable Ladder QuikLock™ Bracket (page J.20)

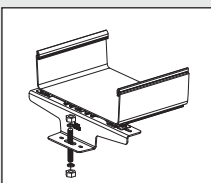

FR12CS58 – Center Support QuikLock™ Bracket (page J.20)

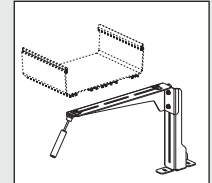

FR12ACAB – Adjustable Cabinet QuikLock™ Bracket (page J.21)

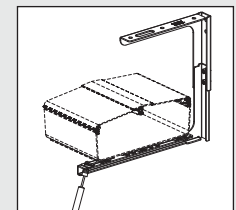

FR12ACB58 – Top Support Adjustable "C" QuikLock™ Bracket (page J.20)

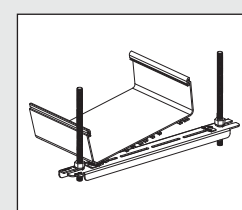

FR12TB58 – Trapezoidal QuikLock™ Bracket (page J.20)

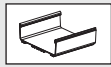

- 1** FR12X4** – 12x4 FiberRunner® Channel (page J.12)



- 2** FRHC12**6 – 12x4 Snap-On Hinged Cover (page J.12)

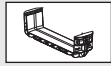

- 3** FRBC12X4** – 12x4 QuikLock™ Coupler (page J.13)



- 4** FRH4512X4** – 12x4 Horizontal 45° Angle Fitting and FRH45SC12** – Optional Split Cover (page J.13)

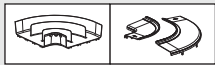

- 5** FRRA12X4** – 12x4 Horizontal Right Angle Fitting and FRRASC12** – Optional Split Cover (page J.13)

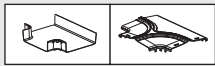

- 6** FRT12X4** – 12x4 Horizontal Tee Fitting and FRTSC12** – Optional Split Cover (page J.13 and J.14)

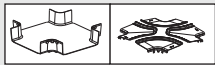

- 7** FRFWC12X4** – 12x4 4-Way Cross Fitting and FRFWCSC12** – Optional Split Cover (page J.14)



- 8** FRVT12X4** – 12x4 Vertical Tee (page J.17)



- 9** FRIV4512X4** – 12x4 Inside Vertical 45° Angle Fitting (page J.15)



- 10** FROV4512X4** – 12x4 Outside Vertical 45° Angle Fitting and FROV45SC12** – Optional Split Cover (page J.15)



- 11** FROVRA12X4** – 12x4 Outside Vertical Right Angle Fitting and FROVRASC12** – Optional Split Cover (page J.15)

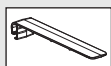

- 12** FRCR12BL-X – Cable Retainer for 12x4 System (page J.12)

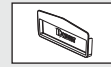

- 13** FREC12X4** – 12x4 End Cap Fitting (page J.15)

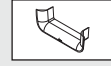

- 14** FRTR12X4** – 3-Sided BRC Trumpet Spillover for 12x4 Exit (page J.19)

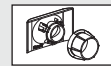

- 15** FR1.5IDE** – 1-Port Spillover Side Exit to 1.5" (38mm) Inside Diameter Corrugated Tubing (page J.19)

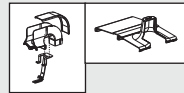

- 16** FRSPJ2X2** – Spill-Over Junction with 2x2 Exit and FRSPJC212** – Optional Cover for 12x4 System (page J.17)

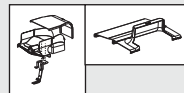

- 17** FRSPJ4X4** – Spill-Over Junction with 4x4 Exit and FRSPJC412** – Optional Cover for 12x4 System (page J.18)

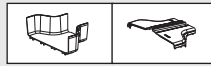

- 18** FRRF126** – 12x4 to 6x4 FiberRunner® Reducer Fitting and FRRF126SC** – Optional Split Cover (page J.16)

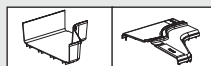

- 19** FRRF126L** – 12x4 to 6x4 Transition Left Reducer Fitting and FRRF126LSC** – Optional Split Cover (page J.16)

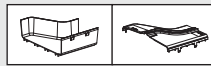

- 20** FRRF126R** – 12x4 to 6x4 Transition Right Reducer Fitting and FRRF126RSC** – Optional Split Cover (page J.16)

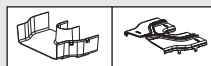

- 21** FRY126** – Y-Reducer from 12x4 to two 6x4 Exit and FRY126SC** – Optional Split Cover (page J.16)



- 22** FRT12X4W6** – 12x4 Horizontal Tee with 6x4 Exit and FRTSC12W6** – Optional Split Cover (page J.14)



- 23** FRFWC12X4W6** – 12x4 4-Way Cross Fitting with 6x4 Exits and FRFWCSC12W6** – Optional Split Cover (page J.14 and J.15)

**Available colors include: YL (Yellow), OR (Orange), and BL (Black).

cUL LISTED **12x4 FiberRunner® Routing System**

Cable Fills for 12x4 FiberRunner® Routing System

The maximum amounts may vary according to the cable fill installation methods, straightness of cables, etc.

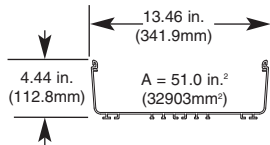

12x4 FiberRunner® Cable Routing System								
Fill/Pile Up	Internal Area (in²)	Diameter 1.6mm 0.063"	Diameter 2.0mm 0.079"	Diameter 3.0mm 0.118"	Fiber Optic Ribbon Interconnect Cable Diameter 5.20mm 0.205"	Category 6A (SD) Diameter 6.1mm 0.240"	Category 6A Diameter 7.6mm 0.300"	Category 6 Diameter 6.1mm 0.240"
40% Fill								
2" Pile Up	25.7	3299	2111	938	311	227	147	209
3" Pile Up	38.8	4980	3187	1417	470	343	223	316
4" Pile Up	51	6546	4189	1862	618	451	292	416
50% Fill								
2" Pile Up	25.7	4124	2639	1173	389	284	184	262
3" Pile Up	38.8	6225	3984	1771	588	429	278	395
4" Pile Up	51	8183	5237	2327	773	564	366	519
60% Fill								
2" Pile Up	25.7	4948	3167	1407	467	341	221	314
3" Pile Up	38.8	7470	4781	2125	705	515	334	474
4" Pile Up	51	9819	6284	2793	927	676	439	623

Channel cutting instructions: For optimum results, use a miter box and saw. For larger quantities use a plastic cutting saw blade for clean, burr-free cuts. Recommend: Carbide 80T and 100T; .090" thickness, .125" kerf.

The above cable diameters represent the nominal Panduit cable diameter per performance level. For specific cable fill information based on specific part numbers, please contact Panduit customer service.

12x4 FiberRunner® Routing System – Channel and Cover

- Robust, large capacity 12x4 system ideal for use with large cable counts
- Multiple spillover options provide versatility to mate to various equipment and rack configurations
- QuikLock™ Couplers and Brackets reduce system installation time dramatically
- Channel, covers, fittings and other non-metallic system components made from V-0 flame class rated material
- Compatible with all sizes of Panduit® FiberRunner® and Panduit® Fiber-Duct™ Routing Systems, cable management, and racks
- Compliant with the applicable tests in Telcordia GR-63-CORE Network Equipment Building Systems (NEBS) Level 3



FR12X4



FRHC12



FRCR12BL-X

Part Number	Part Description	Std. Pkg. Qty.	Std. Ctn. Qty.
12x4 FiberRunner® Channel			
FR12X4YL6	Used to carry the cables horizontally throughout the system. Accepts cable retainers FRCR12BL-X or hinged cover FRHC12YL6. Use QuikLock™ Coupler FRBC12X4YL to attach channel and/or fittings.	6	12
12x4 Snap-On Hinged Cover			
FRHC12YL6	Optional snap-on hinged cover for channel FR12X4YL6. Can be folded down for height restricted areas.	6	12
Cable Retainer for 12x4 System			
FRCR12BL-X	Cable retainer holds cable in the channel when cover is not used. Install anywhere on channel, near the coupler or every 18" (457mm). Black color only.	10	100

For other colors replace YL (Yellow) with OR (Orange) or BL (Black).
Order number of feet required, in multiples of standard 6' length increments.
Order number of cable retainers required, in multiples of Standard Package Quantity.

12x4 FiberRunner® QuikLock™ Coupler

- Pre-assembled to provide fast mechanical assembly of components
- No tools required for installation; bolts loosen for component disassembly



Part Number	Part Description	Std. Pkg. Qty.	Std. Ctn. Qty.
FRBC12X4YL	Pre-assembled coupler quickly joins two sections of channel and/or fittings. Mechanically attaches without tightening bolts. Bolts release using 3/8" nut driver to allow coupler to be removed if necessary.	1	5

For a bulk package of 10 couplers, order FRBC12X4YL-X.
For other colors replace suffix YL (Yellow) with OR (Orange) or BL (Black).

12x4 FiberRunner® System Fittings

- Minimum 2" (50.8mm) bend radius control fittings
- Optional split covers snap onto each fitting
- Protect against signal loss and performance degradation
- Covers feature 3/4" (19mm) gap to allow cable to be laid in
- Assemble using FRBC QuikLock™ Couplers

Part Number	Part Description	Couplers Required	Std. Pkg. Qty.	Std. Ctn. Qty.
-------------	------------------	-------------------	----------------	----------------

12x4 Horizontal Right Angle Fitting



FRRA12X4

FRRA12X4YL	Attaches to 12x4 channel and/or fitting to create a 90° horizontal turn from a straight horizontal run. Inside divider walls manage cables routed around horizontal right angles. Accepts optional split cover FRRASC12YL.	(2 pcs.) FRBC12X4YL	1	—
-------------------	--	------------------------	---	---

Split Cover for 12x4 Horizontal Right Angle Fitting



FRRASC12

FRRASC12YL	Optional split cover for the horizontal right angle fitting FRRA12X4YL. Snap-on feature allows cover to be installed and removed with no tools required. Creates radsided 3/4" (19mm) opening for easy access to add or remove cables.	—	1	5
-------------------	--	---	---	---

12x4 Horizontal 45° Angle Fitting



FRH4512X4

FRH4512X4YL	Attaches to 12x4 channel and/or fitting to create a 45° horizontal turn from a straight horizontal run. Accepts optional split cover FRH45SC12YL.	(2 pcs.) FRBC12X4YL	1	—
--------------------	---	------------------------	---	---

Split Cover for 12x4 Horizontal 45° Angle Fitting



FRH45SC12

FRH45SC12YL	Optional split cover for the horizontal 45° angle fitting FRH4512X4YL. Snap-on feature allows cover to be installed and removed with no tools required. Creates radsided 3/4" (19mm) opening for easy access to add or removes cables.	—	1	5
--------------------	--	---	---	---

12x4 Horizontal Tee Fitting

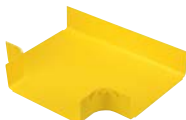

FRT12X4

FRT12X4YL	Attaches to 12x4 channel and/or fittings to create a 90° horizontal branch with a 12x4 exit from straight horizontal run. Accepts optional split cover FRTSC12YL.	(3 pcs.) FRBC12X4YL	1	—
------------------	---	------------------------	---	---

For other colors replace suffix YL (Yellow) with OR (Orange) or BL (Black).

Table continues on page J.14

12x4 FiberRunner[®] System Fittings (continued)**FRTSC12****FRT12X4W6****FRTSC12W6****FRT12X4W4****FRTSC12W4****FRFWC12X4****FRFWCSC12****FRFWC12X4W6**

Part Number	Part Description	Couplers Required	Std. Pkg. Qty.	Std. Ctn. Qty.
-------------	------------------	-------------------	----------------	----------------

Split Cover for 12x4 Horizontal Tee Fitting

FRTSC12YL	Optional split cover for the horizontal tee fitting FRT12X4BL. Snap-on feature allows cover to be installed and removed with no tools required. Creates radiused 3/4" (19mm) opening for easy access to add or remove cables.	—	1	5
------------------	---	---	---	---

12x4 Horizontal Tee with 6x4 Exit

FRT12X4W6YL	Attaches to 12x4 channel and/or fittings to create a 90° horizontal branch with a 6x4 exit from straight horizontal run. Accepts optional split cover FRTSC12W6YL.	(2 pcs.) FRBC12X4YL (1 pc.) FRBC6X4YL	1	—
--------------------	--	--	---	---

Split Cover for 12x4 Horizontal Tee with 6x4 Exit

FRTSC12W6YL	Optional split cover for the horizontal tee with 6x4 exit fitting FRT12X4W6YL. Snap-on feature allows cover to be installed and removed without tools. Creates radiused 3/4" (19mm) opening for easy access to add or remove cables.	—	1	5
FRT12X4W4YL	Attaches to 12x4 channel and/or fittings to create a 90° horizontal branch with a 4x4 exit from straight horizontal run. Accepts optional split cover FRTSC12W4YL.	(2 pcs.) FRBC12X4YL (1 pc.) FRBC4X4YL	1	—
FRTSC12W4YL	Split Cover, Horizontal Tee with 12x4 Exit.	—	1	5

12x4 Four Way Cross Fitting

FRFWC12X4YL	Attaches to 12x4 channel and/or fittings to create a horizontal four way cross intersection with two 12x4 exits. Accepts optional split cover FRFWCSC12YL.	(4 pcs.) FRBC12X4YL	1	—
--------------------	--	------------------------	---	---

Split Cover for 12x4 Four Way Cross Fitting

FRFWCSC12YL	Optional split cover for the four way cross fitting FRFWC12X4YL. Snap-on feature allows cover to be installed and removed with no tools required. Creates radiused 3/4" (19mm) opening for easy access to add or remove cables.	—	1	5
--------------------	---	---	---	---

12x4 Four Way Cross Fitting with 6x4 Exits

FRFWC12X4W6YL	Attaches to 12x4 channel and/or fittings to create a horizontal four way cross intersection with two 6x4 exits. Accepts optional split cover FRFWCSC12W6YL.	(2 pcs.) FRBC12X4YL (2 pcs.) FRBC6X4YL	1	—
----------------------	---	---	---	---

For other colors replace suffix YL (Yellow) with OR (Orange) or BL (Black).

12x4 FiberRunner® System Fittings (continued)



FRFWCSC12W6



FRFWC12X4W4



FRFWCSC12W4



FREC12X4



FRIV4512X4



FROV4512X4



FROV45SC12



FROVRA12X4



FROVRASC12

Part Number	Part Description	Couplers Required	Std. Pkg. Qty.	Std. Ctn. Qty.
Split Cover for 12x4 Four Way Cross Fitting with 6x4 Exits				
FRFWCSC12W6YL	Optional split cover for the four way cross fitting FRFWC12X4W6YL. Snap-on feature allows cover to be installed and removed with no tools required. Creates radiused 3/4" (19mm) opening for easy access to add or remove cables.	—	1	5
FRFWC12X4W4YL	Attaches to 12x4 channel and/or fittings to create a horizontal four way cross intersection with two 4x4 exits.	(2 pcs.) FRBC12X4YL (2 pcs.) FRBC4X4YL	1	—
FRFWCSC12W4YL	Optional split cover for the four way cross fitting FRFWC12X4W4YL. Snap-on feature allows cover to be installed and removed with no tools required. Creates radiused 3/4" (19mm) opening for easy access to add or remove cables.	—	1	5
12x4 End Cap Fitting				
FREC12X4YL	Used for closing off open ends of the channel or fittings. No coupler required. Push-on installation.	—	1	5
12x4 Inside Vertical 45° Angle Fitting				
FRIV4512X4YL	Attaches to 12x4 channel and/or fitting to create a 45° upward angle from a straight horizontal run. Used with outside vertical 45° angle fitting FROV4512X4YL to change level of a straight horizontal run. Includes split cover.	(2 pcs.) FRBC12X4YL	1	—
12x4 Outside Vertical 45° Angle Fitting				
FROV4512X4YL	Attaches to 12x4 channel and/or fitting to create a 45° downward angle from a straight horizontal run. Used with inside vertical 45° angle fitting FRIV4512X4YL to change level of a horizontal run. Accepts optional split cover FROV45SC12YL.	(2 pcs.) FRBC12X4YL	1	—
Split Cover for 12x4 Outside Vertical 45° Angle Fitting				
FROV45SC12YL	Optional split cover for the outside vertical 45° angle fitting FROV4512X4YL. Snap-on feature allows cover to be installed and removed with no tools required. Creates radiused 3/4" (19mm) opening for easy access to add or remove cables.	—	1	5
12x4 Outside Vertical Right Angle Fitting				
FROVRA12X4YL	Attaches to 12x4 channel and/or fittings to create a 90° vertical turn down from a straight horizontal run. Accepts optional split cover FROVRASC12YL.	(2 pcs.) FRBC12X4YL	1	—
Split Cover for 12x4 Outside Vertical Right Angle Fitting				
FROVRASC12YL	Optional split cover for the outside vertical right angle fitting FROVRA12X4YL. Snap-on feature allows cover to be installed and removed with no tools required. Creates radiused 3/4" (19mm) opening for easy access to add or remove cables.	—	1	5

For other colors replace suffix YL (Yellow) with OR (Orange) or BL (Black).

Table continues on page J.16

12x4 FiberRunner[®] System Fittings (continued)



FRRF126



FRRF126SC



FRY126



FRY126SC



FRRF126R



FRRF126RSC



FRRF126L



FRRF126LSC

Part Number	Part Description	Couplers Required	Std. Pkg. Qty.	Std. Ctn. Qty.
-------------	------------------	-------------------	----------------	----------------

12x4 to 6x4 FiberRunner[®] Reducer Fitting

FRRF126YL	Attaches any 12x4 FiberRunner [®] Fitting or Channel to any 6x4 FiberRunner [®] Fitting or Channel. Accepts split cover FRRF126SCYL.	(1 pc.) FRBC12X4YL (1 pc.) FRBC6X4YL	1	—
------------------	--	---	---	---

Split Cover for 12x4 to 6x4 FiberRunner[®] Reducer Fitting

FRRF126SCYL	Optional split cover for the reducer fitting FRRF126YL. Snap-on feature allows cover to be installed and removed with no tools required. Creates radiused 3/4" (19mm) opening for easy access to add or remove cables.	—	1	5
--------------------	--	---	---	---

Y-Reducer from 12x4 to Two 6x4 Exits

FRY126YL	Attaches any 12x4 FiberRunner [®] Fitting or Channel to two 6x4 FiberRunner [®] Channels. Accepts split cover FRY126SCYL.	(1 pc.) FRBC12X4YL (2 pcs.) FRBC6X4YL	1	—
-----------------	---	--	---	---

Split Cover for Y-Reducer from 12x4 to Two 6x4 Exits

FRY126SCYL	Optional split cover for the Y-reducer fitting FRY126YL. Snap-on feature allows cover to be installed and removed with no tools required. Creates radiused 11/16" (17.5mm) opening for easy access to add or remove cables.	—	1	5
-------------------	---	---	---	---

12x4 to 6x4 Transition Right Reducer Fitting

FRRF126RYL	Attaches any 12x4 FiberRunner [®] Fitting or Channel to any 6x4 FiberRunner [®] Fitting or Channel while transitioning to the right. Accepts split cover FRRF126RSCYL.	(1 pc.) FRBC12X4YL (1 pc.) FRBC6X4YL	1	—
-------------------	--	---	---	---

Split Cover for 12x4 to 6x4 Transition Right Reducer Fitting

FRRF126RSCYL	Optional split cover for the transition right reducer fitting FRRF126RYL. Snap-on feature allows cover to be installed and removed with no tools required. Creates radiused 1/2" (12.7mm) opening for easy access to add or remove cables.	—	1	5
---------------------	--	---	---	---

12x4 to 6x4 Transition Left Reducer Fitting

FRRF126LYL	Attaches any 12x4 FiberRunner [®] Fitting or Channel to any 6x4 FiberRunner [®] Fitting or Channel while transitioning to the left. Accepts split cover FRRF126LSCYL.	(1 pc.) FRBC12X4YL (1 pc.) FRBC6X4YL	1	—
-------------------	---	---	---	---

Split Cover for 12x4 to 6x4 Transition Left Reducer Fitting

FRRF126LSCYL	Optional split cover for the transition left reducer fitting FRRF126LYL. Snap-on feature allows cover to be installed and removed with no tools required. Creates 1/2" (12.7mm) opening for easy access to add or remove cables.	—	1	5
---------------------	--	---	---	---

For other colors replace suffix YL (Yellow) with OR (Orange) or BL (Black).

12x4 FiberRunner® System Spillouts

- Spill-overs allow safe transition from horizontal to vertical runs
- 2" (50.8mm) bend radius control
- Transition to channel, slotted channel, and corrugated loom tubing
- Spill-over junction fittings can be retro-fitted to existing horizontal runs



FRVT12X4



FRTR6X4



FRIDT6X4



FRHD4KT



TRC4HDBL



FRLPR64BL



FRSPJ2X2



FRSPJC212

Part Number	Part Description	Couplers Required	Std. Pkg. Qty.	Std. Ctn. Qty.
12x4 Vertical Tee				
FRVT12X4YL	Attaches to 12x4 channel and/or fittings to create a 90° vertical drop from a horizontal run. Hinged door included. Requires coupler to attach FRTR6X4YL or FRIDT6X4YL to vertical exit. Accepts optional snap-on cover FRHC12YL6 in conjunction with channel.	(2 pcs.) FRBC12X4YL (1 pc.) FRBC6X4YL	1	—
3-Sided BRC Trumpet Spillout for 6x4 Exit				
FRTR6X4YL	Used to limit the bend radius of the cable to 2" (50.8mm) when exiting from 6x4 channel, 6x4 horizontal tee fitting, or 6x4 exit on 12x4 vertical tee.	(1 pc.) FRBC6X4YL	1	5
3-Port Spillout to 1.5" (38mm) Inside Diameter Corrugated Tubing				
FRIDT6X4YL	Used to route cable into three separate pieces of 1.5" (38mm) diameter split corrugated tubing. Used with FRVT12X4YL or any 6x4 fitting. Securely holds corrugated split tubing to ensure system integrity and easy access to add or remove cables.	(1 pc.) FRBC6X4YL	1	5
4x4 Hinged Duct Vertical Cable Manager Kit				
FRHD4KTYL	Provides secure, accessible route for cables spilling out from vertical tee to rack mounted equipment. Kit includes 6' length of 4x4 capacity hinged duct, 6' length of 4x4 hinged duct cover, one end cap for 4x4 hinged duct, three FZBA1.5X4 adjustable "Z" brackets, an adapter fitting, six WR4-C wire retainers and all required mounting hardware. Attaches directly to 6x4 and 4x4 vertical tee exit or FRLPR64 low profile reducer.	—	1	—
4x4 Hinged Duct Bend Radius Control Trumpet				
TRC4HDBL	Bend radius control trumpet for exiting at the sidewall of 4" wall heights of type H hinged cover wiring duct channels. Maintains 1" (25.4mm) bend radius control. Black color only.	—	1	10
Low Profile Reducer 6x4 to 4x4 for Vertical Tee				
FRLPR64BL	Assembled into the 12x4 vertical tee FRVT12X4YL. The FRLPR64BL allows for the transition to 4x4 Fiber-Duct™ Channel with minimal space required. No tools required for assembly. Black color only.	—	1	5
Spill-Over Junction with 2x2 Exit				
FRSPJ2X2YL	Assembles onto 4x4, 6x4, 12x4, or 24x4 FiberRunner® Channel, spilling over the side into a 2x2 vertical exit. Requires coupler to attach 2x2 FiberRunner® and fittings to the vertical exit. Mounts directly to existing installation with no alteration required. Mounting hardware provided for secure attachment.	(1 pc.) FBC2X2YL	1	—
Cover for Spill-Over Junction with 2x2 Exit for 12x4 Channel				
FRSPJC212YL	Used to fully enclose 12x4 channel in conjunction with the spill-over junction FRSPJ2X2YL. Cover snaps onto the channel base. Hinged feature allows easy access to add or remove cables.	—	1	5

For other colors replace suffix YL (Yellow) with OR (Orange) or BL (Black).

Table continues on page J.18

12x4 FiberRunner[®] System Spillouts (continued)**FTR2X2****FIDT2X2YL****FRHD2KT****TRC2HDBL****FRSPJ4X4****FRSPJC412**

Part Number	Part Description	Couplers Required	Std. Pkg. Qty.	Std. Ctn. Qty.
-------------	------------------	-------------------	----------------	----------------

3-Sided BRC Trumpet Spillover for 2x2 Exit

FTR2X2YL	Used to limit the bend radius of the cable to 2" (50.8mm) when exiting from a spill-over junction with a 2x2 exit or from 2x2 Fiber-Duct™ Channel. Securely holds split corrugated tubing to ensure system integrity and easy access to add or remove cables.	(1 pc.) FBC2X2YL	1	5
-----------------	---	---------------------	---	---

1-Port Spillover to 1.5" (38mm) Inside Diameter Corrugated Tubing

FIDT2X2YL	Used to route cable into one piece of 1.5" (38mm) diameter split corrugated tubing. Used with a spill-over junction with a 2x2 exit, 2x2 Fiber-Duct™ Fittings, and the 2x2 FiberRunner [®] Hinged Channel. Securely holds split corrugated tubing to ensure system integrity and easy access to add or remove cables.	(1 pc.) FBC2X2YL	1	5
------------------	--	---------------------	---	---

2x2 Hinged Duct Vertical Cable Manager Kit

FRHD2KTYL	Provides secure, accessible route for cables spilling out from a vertical tee or spill-over junction to rack mounted equipment. Kit includes 6' length of 2x2 FiberRunner [®] Hinged Channel H2X2YL6, 6' length of 2x2 snap-on hinged cover HC2YL6, four adjustable "Z" brackets FZBA1.5X4, one FiberRunner [®] 2x2 End Cap FHDEC2X2YL, six hinged duct 2" wire retainers WR2H-C and all required mounting hardware. Attaches to 2x2 vertical tee exit or spill-over junction with a 2x2 exit with a 2x2 QuikLock™ Coupler FBC2X2YL. Also attaches directly to 4x4 or 6x4 vertical tee exits with low profile reducer FRLPR42BL.	—	1	—
------------------	--	---	---	---

2x2 FiberRunner[®] Bend Radius Control Trumpet

TRC2HDBL	Bend radius control trumpet for exiting at the sidewall of 2" wall heights of type H hinged cover wiring duct channels. Maintains 1" (25.4mm) bend radius control. Black color only.	—	1	10
-----------------	--	---	---	----

Spill-Over Junction with 4x4 Exit

FRSPJ4X4YL	Assembles onto 4x4, 6x4, 12x4, or 24x4 FiberRunner [®] Channel, spilling over the side into a 4x4 vertical exit. Requires coupler to attach 4x4 FiberRunner [®] Channel and fittings to the vertical exit. Mounts directly to existing installation with no alteration required. Mounting hardware provided for secure attachment.	(1 pc.) FRBC4X4YL	1	—
-------------------	--	----------------------	---	---

Cover for Spill-Over Junction with 4x4 Exit for 12x4 Channel

FRSPJC412YL	Used to fully enclose 12x4 channel in conjunction with the spill-over junction FRSPJ4X4YL. Cover snaps onto the channel base. Hinged feature allows easy access to add or remove cables.	—	1	5
--------------------	--	---	---	---

For other colors replace suffix YL (Yellow) with OR (Orange) or BL (Black).

12x4 FiberRunner® System Spillouts (continued)



Part Number	Part Description	Couplers Required	Std. Pkg. Qty.	Std. Ctn. Qty.
3-Sided BRC Trumpet Spillout for 4x4 FiberRunner® Exit				
FRTR4X4YL	Used to limit the bend radius of the cable to 2" (50.8mm) when exiting from 4x4 FiberRunner® Channel or a 4x4 FiberRunner® Horizontal Tee.	(1 pc.) FRBC4X4YL	1	5
2-Port Spillout to 1.5" (38mm) Inside Diameter Corrugated Tubing				
FRIDT4X4YL	Used to route cable into one or two pieces of 1.5" (38mm) diameter split corrugated tubing. Requires coupler to be used with 4x4 FiberRunner® Fitting. Used with any 4x4 FiberRunner® Fitting. Securely holds corrugated split tubing to ensure system integrity and easy access to add or remove cables.	(1 pc.) FRBC4X4YL	1	5
1-Port Spillout Side Exit to 1.5" (38mm) Inside Diameter Corrugated Tubing				
FR1.5IDEYL	Used to route cable into 1.5" (38mm) diameter split corrugated tubing directly through a hole cut in the side wall of the 4x4, 6x4, and 12x4 FiberRunner® Channel or 4x4 Fiber-Duct™ Channel. Provides 1" (25.4mm) bend radius control at the exit. Securely holds split corrugated tubing to ensure system integrity and easy access to add or remove cables. Includes drilling template.	—	1	5
3-Sided BRC Trumpet Spillout for 12x4 Exit				
FRTR12X4YL	Used to limit the bend radius of the cable to 2" (50.8mm) when exiting from the 12x4 channel or a 12x4 horizontal tee.	(1 pc.) FRBC12X4YL	1	5

For other colors replace suffix YL (Yellow) with OR (Orange) or BL (Black).

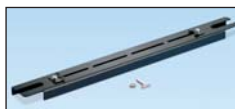
12x4 FiberRunner[®] Mounting Brackets**FR12TRBE58**
FR12TRBE58M**FR12TRBN58**
FR12TRBN58M**FR12USB****FR12ALB****FR12CS12**
FR12CS58
FR12CS12M
FR12CS58M**FR12ACB12**
FR12ACB58
FR12ACB12M
FR12ACB58M**FR12TB12**
FR12TB58
FR12TB12M
FR12TB58M

Part Number	Part Description	For Threaded Rod Size	Std. Pkg. Qty.	Std. Ctn. Qty.
-------------	------------------	-----------------------	----------------	----------------

Existing Threaded Rod QuikLock[™] Bracket for 12x4 System

FR12TRBE58	Used to support the 12x4 system from existing threaded rod installations. Bracket is secured to threaded rod with two split nuts. The pre-assembled slide clamps enable fast assembly to channel. Use 7/16" nut driver on slide clamps.	5/8"	1	—
FR12TRBE58M		16mm	1	—

New Threaded Rod QuikLock[™] Bracket for 12x4 System

FR12TRBN58	Used to support the 12x4 system from new threaded rod installations. Bracket is secured to threaded rod with two nuts. The pre-assembled slide clamps enable fast assembly to channel. Use 7/16" nut driver on slide clamps.	5/8"	1	—
FR12TRBN58M		16mm	1	—

Underfloor Pedestal QuikLock[™] Bracket for 12x4 System

FR12USB	Used to support the 12x4 system by attaching to underfloor pedestals. (Contains all necessary hardware.) Use on pedestals up to 2" in diameter. The pre-assembled slide clamps enable fast assembly to channel. Use 7/16" nut driver on slide clamps.	—	1	—
----------------	---	---	---	---

Adjustable Ladder QuikLock[™] Bracket for 12x4 System

FR12ALB	Used to support the 12x4 system attaching to any 3/8" (9.5mm) x 1 1/2" (38.1mm) or 3/8" (9.5mm) x 2" (50.8mm) ladder rack rail. Adjustable to nine incremental positions from 4" (101mm) to 12" (305mm) above or below the ladder rack. No threaded rod required. The pre-assembled slide clamps enable fast assembly to channel. Use 7/16" nut driver on slide clamps.	—	1	—
----------------	---	---	---	---

Center Support QuikLock[™] Bracket for 12x4 System

FR12CS12	Used to support the 12x4 system from below with new threaded rod. Bracket is secured to threaded rod with two nuts. The pre-assembled slide clamps enable fast assembly to channel. Use 7/16" nut driver on slide clamps. Also can be secured directly to the top of cabinets.	1/2"	1	—
FR12CS58		5/8"	1	—
FR12CS12M		12mm	1	—
FR12CS58M		16mm	1	—

Top Support Adjustable "C" QuikLock[™] Bracket for 12x4 System

FR12ACB12	Used to support the 12x4 system from any new threaded rod extending down directly from the ceiling, grid, or ladder rack system. Two position height adjustments to accommodate system with or without hinged cover. Bracket is secured to threaded rod with two nuts. The pre-assembled slide clamps enable fast assembly to channel. Use 7/16" nut driver on slide clamps.	1/2"	1	—
FR12ACB58		5/8"	1	—
FR12ACB12M		12mm	1	—
FR12ACB58M		16mm	1	—

Trapeze QuikLock[™] Bracket for 12x4 System

FR12TB12	Used to support the 12x4 system by spanning two threaded rod drops that are 18" apart. Can be installed from above or below. Bracket is secured to each threaded rod with two nuts. The pre-assembled slide clamps enable fast assembly to channel. Use 7/16" nut driver on slide clamps.	1/2"	1	—
FR12TB58		5/8"	1	—
FR12TB12M		12mm	1	—
FR12TB58M		16mm	1	—

12x4 FiberRunner® Mounting Brackets (continued)



FRTBWG18BL



FRTBWG24BL



FRTBWG30BL



FR12TB2412
FR12TB2458
FR12TB2412M
FR12TB2458M



FR12ACAB

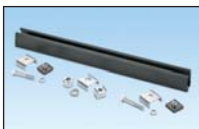

FR4PRB58

Part Number	Part Description	For Threaded Rod Size	Std. Pkg. Qty.	Std. Ctn. Qty.
Wyr-Grid® Mounting Brackets for FiberRunner® System				
FRTBWG18BL	FiberRunner® QuikLock™ Threaded Rod Trapeze Bracket for Wyr-Grid® 18" (457mm) width. Used to support FiberRunner® 4x4, 6x4, and 12x4 Channel above or below the Wyr-Grid® 18" Pathway using the same 1/2" or 12mm threaded rod used to support the WGTB18BL bracket. Hardware for attaching to threaded rod sold separately.	1/2" 12mm	1	10
FRTBWG24BL	FiberRunner® QuikLock™ Threaded Rod Trapeze Bracket for Wyr-Grid® 24" (610mm) width. Used to support FiberRunner® 4x4, 6x4, and 12x4 Channel above or below the Wyr-Grid® 24" Pathway using the same 1/2" or 12mm threaded rod used to support the WGTB24BL bracket. Hardware for attaching to threaded rod sold separately.	1/2" 12mm	1	10
FRTBWG30BL	FiberRunner® QuikLock™ Threaded Rod Trapeze Bracket for Wyr-Grid® 30" (762mm) width. Used to support FiberRunner® 4x4, 6x4, 12x4, and 24x4 Channel above or below the Wyr-Grid® 30" Pathway using the same 1/2" or 12mm threaded rod used to support the WGTB30BL bracket. Quick mount clips, FRQMC24-X are not included for installing the 24x4 channel. These must be purchased separately. Hardware for attaching to threaded rod sold separately.	1/2" 12mm	1	10

Trapeze QuikLock™ Bracket for 12x4 System

FR12TB2412	Used to support the 12x4 system by spanning two threaded rod drops that are 24" apart. Ideal for supporting trapeze bracket from 24" wide ladder rack or 24" wide cable tray. Can be installed from above or below. Bracket is secured to each threaded rod with two nuts. The pre-assembled slide clamps enable fast assembly to channel. Use 7/16" nut driver on slide clamps.	1/2"	1	—
FR12TB2458		5/8"	1	—
FR12TB2412M		12mm	1	—
FR12TB2458M		16mm	1	—

Adjustable Cabinet QuikLock™ Bracket for 12x4 System

FR12ACAB	Used to support the 12x4 system, dual 6x4, or dual 4x4 systems attaching to the top of cabinets. Adjustable from 4 1/4" (108mm) to 12" (305mm) allowing runs to be leveled over uneven cabinet heights. Also allows spillouts such as vertical tee to be positioned directly over cable inlets on cabinet tops. Bracket is secured to the cabinet frame with through bolts (not included). The pre-assembled slide clamps enable fast assembly to channel. Use 7/16" nut driver on slide clamps.	—	1	—
----------	--	---	---	---

4 Post Rack Bracket

FR4PRB58	Used to support 12x4, 6x4, and 4x4 systems attaching to the top of the 19" wide version of the Panduit NF4PR84 4 post rack. Contains all hardware required to assemble bracket to the top of the 4 post rack. Bracket accepts 5/8" threaded rod (not included).	5/8"	1	—
----------	---	------	---	---

A.
System
Overview

B.
Copper
Systems

C.
Fiber
Optic
Systems

D.
Power
over
Ethernet

E.
Zone
Cabling

F.
Wireless

G.
Outlets

H.
Media
Distribution

I.
Physical
Infrastructure
Management

J.
Overhead &
Underfloor
Routing

K.
Surface
Raceway

L.
Cabinets,
Racks &
Cable
Management

M.
Grounding &
Bonding

N.
Industrial

O.
Labeling &
Identification

P.
Cable
Management
Accessories

Q.
Index

12x4 FiberRunner[®] Mounting Brackets (continued)**F2PCLB12**
F2PCLB58**FRAF58****FR12BS-L****FRTBKT-X**

Part Number	Part Description	For Threaded Rod Size	Std. Pkg. Qty.	Std. Ctn. Qty.
-------------	------------------	-----------------------	----------------	----------------

Two-Piece Ladder Rack Bracket for Attaching Threaded Rod to 1 1/2" — 2" Ladder Rack

F2PCLB12	Two-piece bracket attaches to 3/8" (9.5mm) wide x 1 1/2" (38.1mm) or 3/8" (9.5mm) wide x 2" (50.8mm) ladder rack rail. Bracket halves slide into position and clamp together on the ladder rack rail, which allows for a one-handed assembly of the threaded rod (not included). Contains bracket and hardware for attaching bracket to ladder rack.	1/2"	1	10
F2PCLB58		5/8"	1	10

Two-Piece Framing Clip for Attaching 5/8" Threaded Rod to 2" x 9/16" C-Channel Auxiliary Framing Bars

FRAF58	Two-piece framing clip attaches to auxiliary framing bars. Framing clip halves slide into position and interlock on the auxiliary framing bars, allowing easier assembly of the threaded rod to bars. Contains two-piece framing clip and hardware for attaching framing clip to auxiliary framing bars. (5/8" threaded rod not included.)	5/8"	1	10
---------------	--	------	---	----

Self-Tapping Screws for 12x4 and 24x4 Brackets and Fittings

FR12BS-L	Self-tapping screws allow selected 12x4 fittings to be fastened directly to mounting brackets for additional support. Screws tap directly into those 12x4 fittings that have plastic bosses. Those part numbers are 12x4 and 24x4 brackets and fittings.	—	50	500
-----------------	--	---	----	-----

1/4" T-Bolt Kit

FRTBKT-X	T-bolts can be used for additional attachment when securing FiberRunner [®] Channel to mounting brackets. For example, a T-bolt can be inserted thru a 12x4 mounting bracket and positioned within the center rib structure on the underside of 12x4 channel. By tightening the nut, the 12x4 channel is more securely fastened to the mounting bracket.	—	10	100
-----------------	---	---	----	-----

6x4 Routing System Roadmap

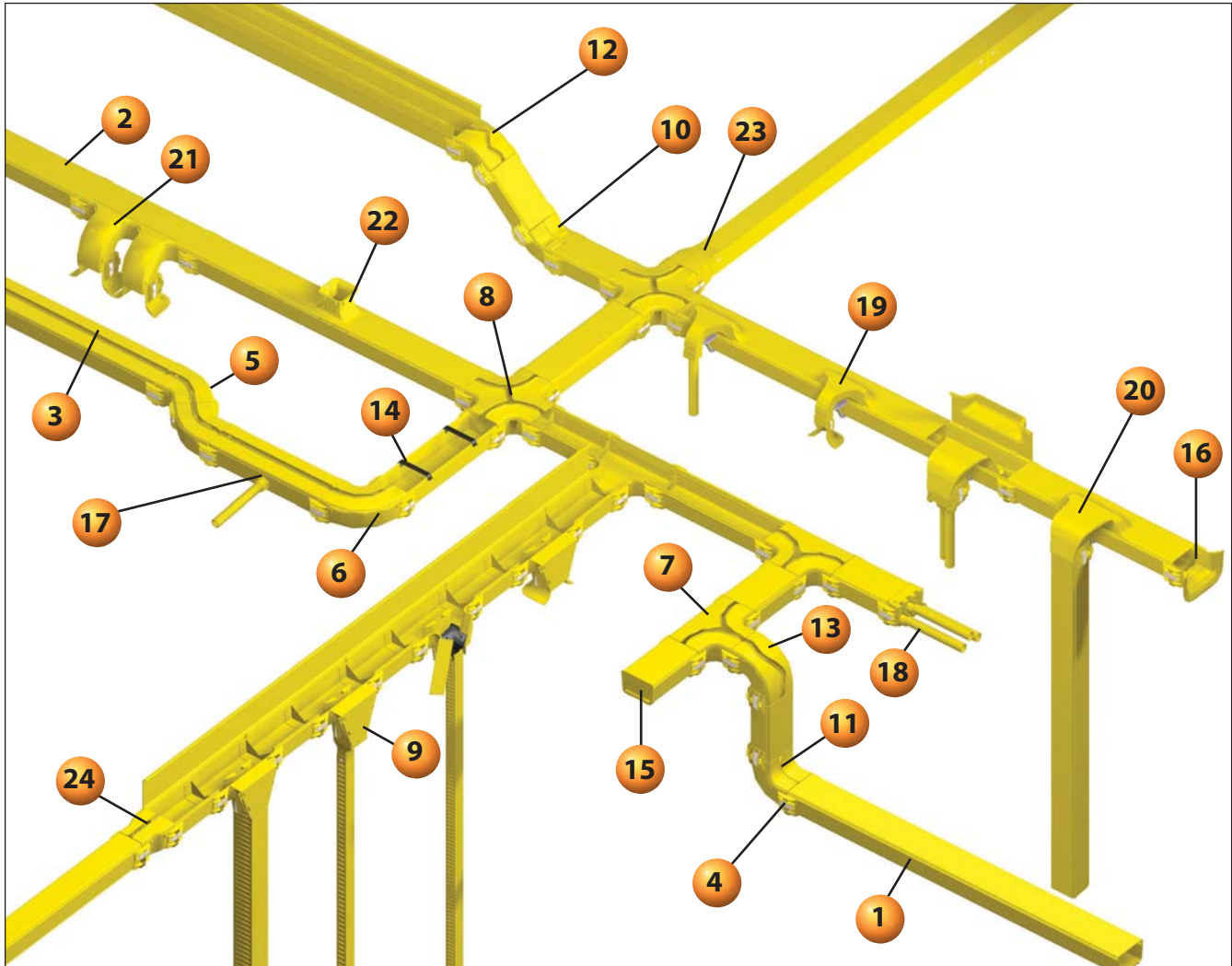

4x4 and 6x4 FiberRunner® Mounting Brackets

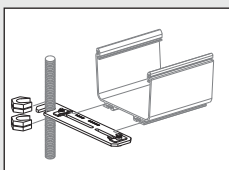

FR6TRBE58 – Existing Threaded Rod QuikLock™ Bracket (page J.33)

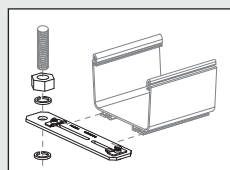

FR6TRBN58 – New Threaded Rod QuikLock™ Bracket (page J.33)

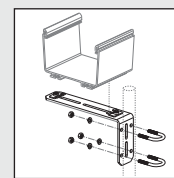

FR6USB – Underfloor Pedestal QuikLock™ Bracket (page J.33)

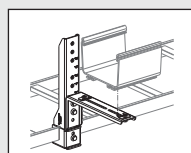

FR6ALB – Adjustable Ladder QuikLock™ Bracket (page J.33)

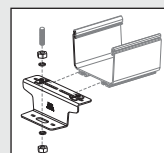

FR6CS58 – Center Support QuikLock™ Bracket (page J.33)

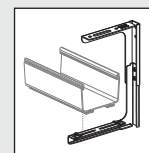

FR6ACB58 – Top Support Adjustable "C" QuikLock™ Bracket (page J.34)

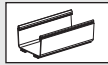

1 FR6X4** – 6x4 FiberRunner® Channel (page J.25)

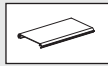

2 FRHC6** – 6x4 Snap-On Hinged Cover (page J.25)

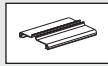

3 FRSHC6** – 6x4 Split Hinged Cover (page J.25)



4 FRBC6X4** – 6x4 QuikLock™ Coupler (page J.26)



5 FRH456X4** – 6x4 Horizontal 45° Angle Fitting and FRH45SC6** – Optional Split Cover (page J.26)



6 FRRA6X4** – 6x4 Horizontal Right Angle Fitting and FRRASC6** – Optional Split Cover (page J.26)

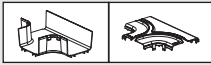

7 FRT6X4** – 6x4 Horizontal Tee Fitting and FRTSC6** – Optional Split Cover (page J.26)

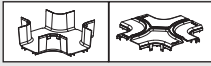

8 FRFWC6X4** – 6x4 4-Way Cross Fitting and FRFWCSC6** – Optional Split Cover (page J.27)

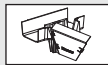

9 FRVT6X4** – 6x4 QuikLock™ Vertical Tee (page J.29)



10 FRIV456X4** – 6x4 Inside Vertical 45° Angle Fitting (page J.27)



11 FRIVRA6X4** – 6x4 Inside Vertical 90° Angle Fitting (page J.27)

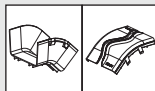

12 FROV456X4** – 6x4 Outside Vertical 45° Angle Fitting and FROV45SC6** – Optional Split Cover (page J.27)

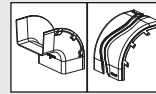

13 FROVRA6X4** – 6x4 Outside Vertical Right Angle Fitting and FROVRASC6** – Optional Split Cover (page J.28)

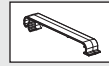

14 FRCR6BL-X – Cable Retainer for 6x4 System (page J.25)



15 FREC6X4** – 6x4 End Cap Fitting (page J.27)



16 FRTR6X4** – 3-Sided BRC Trumpet Spillout for 6x4 Exit (page J.32)

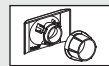

17 FR1.5IDE** – 1-Port Spillout Side Exit to 1.5" (38mm) Inside Diameter Corrugated Tubing (page J.31)



18 FRIDT6X4** – 3-Port Spillout to 1.5" (38mm) Inside Diameter Corrugated Tubing (page J.32)

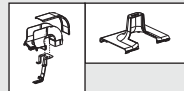

19 FRSPJ2X2** – Spill-Over Junction with 2x2 Exit and FRSPJC26** – Optional Cover for 6x4 System (pages J.29 and J.30)

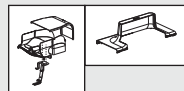

20 FRSPJ4X4** – Spill-Over Junction with 4x4 Exit and FRSPJC46** – Optional Cover for 6x4 System (page J.30)

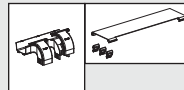

21 FRDDS6X4** – 6x4 Dual Downspout and FRDDSHC6** – Optional Cover for 6x4 Dual Downspout (page J.31)



22 FRUPS6X4** – 6x4 Up Spout (page J.32)



23 FRRF64** – 6x4 FiberRunner® Fitting to 4x4 Fiber-Duct™ Channel Reducer Fitting (page J.28)

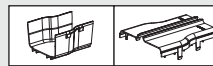

24 FRRF6FR4** – 6x4 to 4x4 FiberRunner® Reducer Fitting and FRRF6FR4SC** – Optional Split Cover (page J.28)

**Available Colors include: YL (Yellow), OR (Orange), and BL (Black).
Note: Additional 6 x 4 and 4 x 4 bracket applications, see page J.38.



6x4 FiberRunner® Routing System

Cable Fills for 6x4 FiberRunner® Cable Routing System

The maximum amounts may vary according to the cable fill installation methods, straightness of cables, etc.

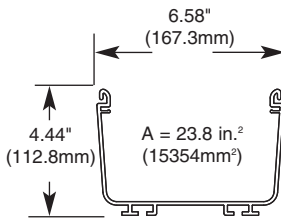

6x4 FiberRunner® Cable Routing System								
Fill/Pile Up	Internal Area (in ²)	Diameter 1.6mm 0.063"	Diameter 2.0mm 0.079"	Diameter 30mm 0.118"	Fiber Optic Ribbon Interconnect Cable Diameter 5.20mm 0.205"	Category 6A (SD) Diameter 6.1mm 0.240"	Category 6A Diameter 7.6mm 0.300"	Category 6 Diameter 6.1mm 0.240"
40% Fill								
2" Pile Up	11.95	1534	982	436	145	106	69	97
3" Pile Up	18.16	2331	1492	663	220	161	104	148
4" Pile Up	23.8	3055	1955	869	288	210	136	194
50% Fill								
2" Pile Up	11.95	1917	1227	545	181	132	86	122
3" Pile Up	18.16	2914	1865	829	275	201	130	185
4" Pile Up	23.8	3819	2444	1086	361	263	171	242
60% Fill								
2" Pile Up	11.95	2301	1472	654	217	158	103	146
3" Pile Up	18.16	3496	2238	994	330	241	156	222
4" Pile Up	23.8	4582	2933	1303	433	316	205	291

Channel cutting instructions: For optimum results, use a miter box and saw. For larger quantities use a plastic cutting saw blade for clean, burr-free cuts. Recommend: Carbide 80T and 100T; .090" thickness, .125" kerf.

The above cable diameters represent the nominal Panduit cable diameter per performance level. For specific cable fill information based on specific part numbers, please contact Panduit customer service.

6x4 FiberRunner® Routing System – Channel and Covers

- Robust, large capacity 6x4 system ideal for use with large cable counts
- Multiple spillout options provide versatility to mate to various equipment and rack configurations
- QuikLock™ Couplers and Brackets reduce system installation time dramatically
- Channel, covers, fittings and other non-metallic system components made from V-0 flame class rated material
- Compatible with all sizes of Panduit® FiberRunner® and Panduit® Fiber-Duct™ Routing Systems, cable management, and racks
- Compliant with the applicable tests in Telcordia GR-63-CORE Network Equipment Building Systems (NEBS) Level 3



FR6X4



FRHC6



FRSHC6



FRCR6BL-X

Part Number	Part Description	Std. Pkg. Qty.	Std. Ctn. Qty.
6x4 FiberRunner® Channel			
FR6X4YL6	Used to carry the cables horizontally throughout the system. Accepts hinged cable retainers FRCR6BL-X, hinged cover FRHC6YL6 or split hinged cover FRSHC6YL6. Use QuikLock™ Coupler FRBC6X4YL to attach channel and/or fittings.	6	36
6x4 Snap-On Hinged Cover			
FRHC6YL6	Optional snap-on hinged cover for channel FR6X4YL6. Hinge feature enables positioning of cover at angles between 30° and 90°.	6	36
6x4 Split Hinged Cover			
FRSHC6YL6	Optional split hinged cover for the channel FR6X4YL6. Creates radiused 3/4" (19mm) opening for easy access to add or remove cables. Snap-on hinge feature enables positioning of cover at angles between 30° and 90°.	6	36
Cable Retainer for 6x4 System			
FRCR6BL-X	Cable retainer holds cable in the channel when cover is not used. Install anywhere on channel, near the coupler or every 18" (457mm). Black color only.	10	100

For other colors replace YL (Yellow) with OR (Orange) or BL (Black).

Order number of feet required, in multiples of standard 6' length increments.

Order number of cable retainers required, in multiples of Standard Package Quantity.

6x4 FiberRunner[®] QuikLock[™] Coupler

- Pre-assembled to provide fast mechanical assembly of components
- No tools required for installation; bolts loosen for component disassembly



Part Number	Part Description	Std. Pkg. Qty.	Std. Ctn. Qty.
FRBC6X4YL	Pre-assembled coupler quickly joins two sections of channel and/or fittings. Mechanically attaches without tightening bolts. Bolts release using 3/8" nut driver to allow coupler to be removed if necessary.	1	5

For a bulk package of 20 couplers, order FRBC6X4YL-E.
For other colors replace suffix YL (Yellow) with OR (Orange) or BL (Black).

6x4 FiberRunner[®] System Fittings

- Minimum 2" (50.8mm) bend radius control fittings
- Protect against signal loss and performance degradation
- Assemble using FRBC QuikLock[™] Couplers
- Optional split covers snap onto each fitting
- Covers feature 3/4" (19mm) gap to allow cable to be laid in

Part Number	Part Description	Couplers Required	Std. Pkg. Qty.	Std. Ctn. Qty.
-------------	------------------	-------------------	----------------	----------------

**FRRA6X4****6x4 Horizontal Right Angle Fitting**

FRRA6X4YL	Attaches to 6x4 channel and/or fittings to create a 90° horizontal turn from a straight horizontal run. Accepts optional split cover FRRASC6YL.	(2 pcs.) FRBC6X4YL	1	5
------------------	---	-----------------------	---	---

**FRRASC6****Split Cover for 6x4 Horizontal Right Angle Fitting**

FRRASC6YL	Optional split cover for the horizontal right angle fitting FRRA6X4YL. Snap-on feature allows cover to be installed and removed with no tools required. Creates radiused 3/4" (19mm) opening for easy access to add or remove cables.	—	1	5
------------------	---	---	---	---

**FRH456X4****6x4 Horizontal 45° Angle Fitting**

FRH456X4YL	Attaches to 6x4 channel and/or fittings to create a 45° horizontal turn from a straight horizontal run. Accepts optional split cover FRH45SC6YL.	(2 pcs.) FRBC6X4YL	1	5
-------------------	--	-----------------------	---	---

**FRH45SC6****Split Cover for 6x4 Horizontal 45° Angle Fitting**

FRH45SC6YL	Optional split cover for the horizontal 45° angle fitting FRH456X4YL. Snap-on feature allows cover to be installed and removed with no tools required. Creates radiused 3/4" (19mm) opening for easy access to add or remove cables.	—	1	5
-------------------	--	---	---	---

**FRT6X4****6x4 Horizontal Tee Fitting**

FRT6X4YL	Attaches to 6x4 channel and/or fittings to create a 90° horizontal branch from a straight horizontal run. Accepts optional split cover FRTSC6YL.	(3 pcs.) FRBC6X4YL	1	5
-----------------	--	-----------------------	---	---

**FRTSC6****Split Cover for 6x4 Horizontal Tee Fitting**

FRTSC6YL	Optional split cover for the horizontal tee fitting FRT6X4YL. Snap-on feature allows cover to be installed and removed with no tools required. Creates radiused 3/4" (19mm) opening for easy access to add or remove cables.	—	1	5
-----------------	--	---	---	---

For other colors replace suffix YL (Yellow) with OR (Orange) or BL (Black).

6x4 FiberRunner® System Fittings (continued)



FRFWC6X4



FRFWCSC6



FREC6X4



FRIVRA6X4



FRIV456X4



FROV456X4



FROV45SC6

Part Number	Part Description	Couplers Required	Std. Pkg. Qty.	Std. Ctn. Qty.
6x4 Four Way Cross Fitting				
FRFWC6X4YL	Attaches to 6x4 channel and/or fittings to create a horizontal four way cross intersection. Accepts optional split cover FRFWCSC6YL.	(4 pcs.) FRBC6X4YL	1	5
Split Cover for 6x4 Four Way Cross Fitting				
FRFWCSC6YL	Optional split cover for the four way cross fitting FRFWC6X4YL. Snap-on feature allows cover to be installed and removed with no tools required. Creates radiused 3/4" (19mm) opening for easy access to add or remove cables.	—	1	5
6x4 End Cap Fitting				
FREC6X4YL	Used for closing off open ends of the channel or fittings. No coupler required. Push-on installation.	—	1	5
6x4 Inside Vertical 90° Angle Fitting				
FRIVRA6X4YL	Attaches to 6x4 channel and/or fittings to create a 90° upward angle from a straight horizontal run. Used with outside vertical 90° angle fitting FROVRA6X4YL to change level of a straight horizontal run. Includes split cover.	(2 pcs.) FRBC6X4YL	1	5
6x4 Inside Vertical 45° Angle Fitting				
FRIV456X4YL	Attaches to 6x4 channel and/or fittings to create a 45° upward angle from a straight horizontal run. Used with outside vertical 45° angle fitting FROV456X4YL to change level of a straight horizontal run. Includes split cover.	(2 pcs.) FRBC6X4YL	1	5
6x4 Outside Vertical 45° Angle Fitting				
FROV456X4YL	Attaches to 6x4 channel and/or fittings to create a 45° downward angle from a straight horizontal run. Used with inside vertical 45° angle fitting FRIV456X4YL to change level of a straight horizontal run. Accepts optional split cover FROV45SC6YL.	(2 pcs.) FRBC6X4YL	1	5
Split Cover for 6x4 Outside Vertical 45° Angle Fitting				
FROV45SC6YL	Optional split cover for the outside vertical 45° angle fitting FROV456X4YL. Snap-on feature allows cover to be installed and removed with no tools required. Creates radiused 3/4" (19mm) opening for easy access to add or remove cables.	—	1	5

For other colors replace suffix YL (Yellow) with OR (Orange) or BL (Black).

A.
System
Overview

B.
Copper
Systems

C.
Fiber
Optic
Systems

D.
Power
over
Ethernet

E.
Zone
Cabling

F.
Wireless

G.
Outlets

H.
Media
Distribution

I.
Physical
Infrastructure
Management

J.
Overhead &
Underfloor
Routing

K.
Surface
Raceway

L.
Cabinets,
Racks &
Cable
Management

M.
Grounding &
Bonding

N.
Industrial

O.
Labeling &
Identification

P.
Cable
Management
Accessories

Q.
Index

6x4 FiberRunner[®] System Fittings (continued)

Part Number	Part Description	Couplers Required	Std. Pkg. Qty.	Std. Ctn. Qty.
6x4 Outside Vertical Right Angle Fitting				
FROVRA6X4YL	Attaches to 6x4 channel and/or fittings to create a 90° vertical turn down from a straight horizontal run. Accepts optional split cover FROVRASC6YL.	(2 pcs.) FRBC6X4YL	1	5
Split Cover for 6x4 Outside Vertical Right Angle Fitting				
FROVRASC6YL	Optional split cover for the outside vertical right angle fitting FROVRA6X4YL. Snap-on feature allows cover to be installed and removed with no tools required. Creates radiused 3/4" (19mm) opening for easy access to add or remove cables.	—	1	5
6x4 to 4x4 FiberRunner[®] Reducer Fitting				
FRRF6FR4YL	Attaches any 6x4 FiberRunner [®] Fitting or Channel to any 4x4 FiberRunner [®] Fitting or Channel. Accepts split cover FRRF6FR4SCYL.	(1 pc.) FRBC6X4YL (1 pc.) FRBC4X4YL	1	5
Split Cover for 6x4 to 4x4 FiberRunner[®] Reducer Fitting				
FRRF6FR4SCYL	Optional split cover for the 6x4 FiberRunner [®] to 4x4 FiberRunner [®] Reducer Fitting FRRF6FR4YL. Snap-on feature allows cover to be installed and removed with no tools required. Creates radiused 3/4" (19mm) opening for easy access to add or remove cables.	—	1	5
6x4 FiberRunner[®] System to 4x4 Fiber-Duct[™] Reducer Fitting				
FRRF64YL	Attaches any 6x4 FiberRunner [®] Fitting or Channel to the 4x4 Fiber-Duct [™] Channel S4X4YL6 or E4X4YL6. Includes solid cover.	(1 pc.) FRBC6X4YL	1	5

For other colors replace suffix YL (Yellow) with OR (Orange) or BL (Black).

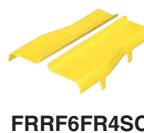

6x4 FiberRunner® System Spillouts

- Spill-overs allow safe transition from horizontal to vertical runs
- 2" (50.8mm) bend radius control
- Transition to channel, slotted channel, and corrugated loom tubing
- Spill-over junction fittings can be retro-fitted to existing horizontal runs



FRVT6X4



FTR4X4



FIDT4X4BL



FRHD4KT



TRC4HDBL



FRLPR42BL



FRSPJ2X2

Part Number	Part Description	Couplers Required	Std. Pkg. Qty.	Std. Ctn. Qty.
6x4 QuikLock™ Vertical Tee				
FRVT6X4YL	Attaches to 6x4 channel and/or fittings to create 90° vertical drop from a straight horizontal run. Hinged door included. Accepts FTR4X4YL, FIDT4X4BL, S4X4YL6 or E4X4YL6 directly. Accepts optional snap-on cover FRHC6YL6 in conjunction with channel.	(2 pcs.) FRBC6X4YL	1	5
3-Sided Vertical Tee Trumpet Spillout				
FTR4X4YL	Used to limit the bend radius of the cable to 2" (50.8mm) when exiting from a 4x4 or 6x4 FiberRunner® Vertical Tee and 4x4 Fiber-Duct™ Fittings.	—	1	5
2-Port Spillout to 1.5" (38mm) Inside Diameter Corrugated Tubing				
FIDT4X4BL	Used to route cable into one or two pieces of 1.5" (38mm) diameter split corrugated tubing. Used with FRVT6X4YL, FRVT4X4YL, or FVT4X4YL. Securely holds corrugated split tubing to ensure system integrity and easy access to add or remove cables. Black color only.	—	1	5
4x4 Hinged Duct Vertical Cable Manager Kit				
FRHD4KTYL	Provides secure, accessible route for cables spilling out from vertical tee to rack mounted equipment. Kit includes 6' length of 4x4 capacity hinged duct, 6' length of 4x4 hinged duct cover, one end cap for 4x4 hinged duct, three FZBA1.5X4 adjustable "Z" brackets, an adapter fitting, six WR4-C wire retainers and all required mounting hardware. Attaches directly to 6x4 and 4x4 vertical tee exit or FRLPR64 low profile reducer.	—	1	—
4x4 Hinged Duct Bend Radius Control Trumpet				
TRC4HDBL	Bend radius control trumpet for exiting at the sidewall of 4" wall heights of type H hinged cover wiring duct channels. Maintains 1" (25.4mm) bend radius control. Black color only.	—	1	10
Low Profile Reducer 4x4 to 2x2 for Vertical Tee				
FRLPR42BL	Assembled into the 6x4 vertical tee FRVT6X4YL or 4x4 vertical tee FRVT4X4YL with an audible snap, the FRLPR42BL allows for the transition to 2x2 FiberRunner® or 2x2 Fiber-Duct™ Channel with minimal space required. No tools required for assembly. Black color only.	—	1	5
Spill-Over Junction with 2x2 Exit				
FRSPJ2X2YL	Assembles onto 4x4, 6x4, 12x4, or 24x4 FiberRunner® Channel, spilling over the side into a 2x2 vertical exit. Requires coupler to attach 2x2 FiberRunner® and fittings to the vertical exit. Mounts directly to existing installation with no alteration required. Mounting hardware provided for secure attachment.	(1 pc.) FBC2X2YL	1	—

For other colors replace suffix YL (Yellow) with OR (Orange) or BL (Black).

Table continues on page J.30

6x4 FiberRunner[®] System Spillouts (continued)**FRSPJC26****FTR2X2****FIDT2X2****FRHD2KT****TRC2HDBL****FRSPJ4X4****FRSPJC46**

Part Number	Part Description	Couplers Required	Std. Pkg. Qty.	Std. Ctn. Qty.
Cover for Spill-Over Junction with 2x2 Exit for 6x4 Channel				
FRSPJC26YL	Used to fully enclose 6x4 channel in conjunction with the spill-over junction FRSPJ2X2YL. Cover snaps onto the channel base. Hinged feature allows easy access to add or remove cables.	—	1	5
3-Sided BRC Trumpet Spillover for 2x2 Exit				
FTR2X2YL	Used to limit the bend radius of the cable to 2" (50.8mm) when exiting from a spill-over junction with a 2x2 exit or from 2x2 Fiber-Duct™ Channel.	(1 pc.) FBC2X2YL	1	5
1-Port Spillover to 1.5" (38mm) Inside Diameter Corrugated Tubing				
FIDT2X2YL	Used to route cable into one piece of 1.5" (38mm) diameter split corrugated tubing. Used with a spill-over junction with a 2x2 exit, 2x2 Fiber-Duct™ Fittings, and the 2x2 FiberRunner [®] Hinged Channel. Securely holds split corrugated tubing to ensure system integrity and easy access to add or remove cables.	(1 pc.) FBC2X2YL	1	5
2x2 Hinged Duct Vertical Cable Manager Kit				
FRHD2KTYL	Provides secure, accessible route for cables spilling out from a vertical tee or spill-over junction to rack mounted equipment. Kit includes 6' length of 2x2 FiberRunner [®] Hinged Channel H2X2YL6, 6' length of 2x2 snap-on hinged cover HC2YL6, four adjustable "Z" brackets FZBA1.5X4, one FiberRunner [®] 2x2 End Cap FHDEC2X2YL, six hinged duct 2" wire retainers WR2H-C, and all required mounting hardware. Attaches to 2x2 vertical tee exit or spill-over junction with a 2x2 exit with a 2x2 QuikLock™ Coupler FBC2X2YL. Also attaches directly to 4x4 or 6x4 vertical tee exits with low profile reducer FRLPR42BL.	—	1	—
2x2 FiberRunner[®] Bend Radius Control Trumpet				
TRC2HDBL	Bend radius control trumpet for exiting at the sidewall of 2" wall heights of type H hinged cover wiring duct channels. Maintains 1" (25.4mm) bend radius control. Black color only.	—	1	10
Spill-Over Junction with 4x4 Exit				
FRSPJ4X4YL	Assembles onto 4x4, 6x4, 12x4, or 24x4 FiberRunner [®] Channel, spilling over the side into a 4x4 vertical exit. Requires coupler to attach 4x4 FiberRunner [®] Channel and fittings to the vertical exit. Mounts directly to existing installation with no alteration required. Mounting hardware provided for secure attachment.	(1 pc.) FRBC4X4YL	1	—
Cover for Spill-Over Junction with 4x4 Exit for 6x4 Channel				
FRSPJC46YL	Used to fully enclose 6x4 channel in conjunction with the spill-over junction FRSPJ4X4YL. Cover snaps onto the channel base. Hinged feature allows easy access to add or remove cables.	—	1	5

For other colors replace suffix YL (Yellow) with OR (Orange) or BL (Black).

6x4 FiberRunner® System Spillouts (continued)



FRDDS6X4



FRDSSH6



FRTR4X4



FRIDT4X4



FR1.5IDE

Part Number	Part Description	Couplers Required	Std. Pkg. Qty.	Std. Ctn. Qty.
6x4 Dual Downspout				
FRDDS6X4YL	Attaches to 6x4 channel and/or fittings to create two 90° 4x4 downward transitions from a horizontal run. The fitting maintains a 2" bend radius control throughout the transition to the vertical downspouts. Includes two snap-on throat covers for the dual downspouts. Accepts optional cover FRDSSH6YL.	(2) FRBC6X4YL (2) FRBC4X4YL	1	—
Cover for 6x4 Dual Downspout				
FRDSSH6YL	Used to fully enclose the 6x4 dual downspout fitting FRDDS6X4YL. Cover is attached to the fitting base with three hinge clips. The hinge clips allow the hinged cover to rotate to a fully closed position and an open position greater than 90°.	—	1	5
3-Sided BRC Trumpet Spillout for 4x4 FiberRunner® Exit				
FRTR4X4YL	Used to limit the bend radius of the cable to 2" (50.8mm) when exiting from 4x4 FiberRunner® Channel or a 4x4 FiberRunner® Horizontal Tee.	(1 pc.) FRBC4X4YL	1	5
2-Port Spillout to 1.5" (38mm) Inside Diameter Corrugated Tubing				
FRIDT4X4YL	Used to route cable into one or two pieces of 1.5" (38mm) diameter split corrugated tubing. Requires coupler to be used with 4x4 FiberRunner® Fitting. Used with any 4x4 FiberRunner® Fitting. Securely holds corrugated split tubing to ensure system integrity and easy access to add or remove cables.	(1 pc.) FRBC4X4YL	1	5
1-Port Spillout Side Exit to 1.5" (38mm) Inside Diameter Corrugated Tubing				
FR1.5IDEYL	Used to route cable into 1.5" (38mm) diameter split corrugated tubing directly through a hole cut in the side wall of the 4x4, 6x4, and 12x4 FiberRunner® Channel or 4x4 Fiber-Duct™ Channel. Provides 1" (25.4mm) bend radius control at the exit. Securely holds split corrugated tubing to ensure system integrity and easy access to add or remove cables. Includes drilling template.	—	1	5

For other colors replace suffix YL (Yellow) with OR (Orange) or BL (Black).

6x4 FiberRunner[®] System Spillouts (continued)

Part Number	Part Description	Couplers Required	Std. Pkg. Qty.	Std. Ctn. Qty.
3-Sided BRC Trumpet Spillout for 6x4 Exit				
FRTR6X4YL	Used to limit the bend radius of the cable to 2" (50.8mm) when exiting from 6x4 channel, 6x4 horizontal tee fitting, or 6x4 exit on 12x4 vertical tee.	(1 pc.) FRBC6X4YL	1	5
6x4 Up Spout				
FRUPS6X4YL	Allows cable to be directed upward out of the channel deployed directly below racks and cabinets in underfloor installations. Provides 2" (50.8mm) bend radius. Snaps directly onto the channel and can be positioned to allow cables to be laid in. A 1" (25.4mm) top bezel is included. Other fittings can be installed for specific applications including FTR4X4YL and FIDT4X4BL.	—	1	5
Innerduct Transition Fitting				
FITF6X4	Metal fitting attaches to end of channel or fitting to transition up to four pieces of solid 1.5" (38mm) inside diameter inner duct. Hardware is included for installation. Black color only.	—	1	10
3-Port Spillout to 1.5" (38mm) Inside Diameter Corrugated Tubing				
FRIDT6X4YL	Used to route cable into three separate pieces of 1.5" (38mm) diameter split corrugated tubing. Used with FRVT12X4YL or any 6x4 fitting. Securely holds corrugated split tubing to ensure system integrity and easy access to add or remove cables.	(1 pc.) FRBC6X4YL	1	5

For other colors replace suffix YL (Yellow) with OR (Orange) or BL (Black).



FRTR6X4



FRUPS6X4



FITF6X4



FRIDT6X4

4x4 and 6x4 FiberRunner® Mounting Brackets



FR6TRBE12
FR6TRBE58
FR6TRBE12M
FR6TRBE58M



FR6TRBN12
FR6TRBN58
FR6TRBN12M
FR6TRBN58M



FR6USB



FR6ALB



FR6CS12
FR6CS58
FR6CS12M
FR6CS58M

Part Number	Part Description	For Threaded Rod Size	Std. Pkg. Qty.	Std. Ctn. Qty.
-------------	------------------	-----------------------	----------------	----------------

Existing Threaded Rod QuikLock™ Bracket for 6x4 and 4x4 Systems

FR6TRBE12	Used to support the 6x4 and 4x4 systems from existing threaded rod installations. Bracket is secured to threaded rod with two split nuts. The pre-assembled slide clamps enable fast assembly to channel. Use 7/16" nut driver on slide clamps.	1/2"	1	10
FR6TRBE58		5/8"	1	10
FR6TRBE12M		12mm	1	10
FR6TRBE58M		16mm	1	10

New Threaded Rod QuikLock™ Bracket for 6x4 and 4x4 Systems

FR6TRBN12	Used to support the 6x4 and 4x4 systems from any new threaded rod installations. Bracket is secured to threaded rod with two nuts. The pre-assembled slide clamps enable fast assembly to channel. Use 7/16" nut driver on slide clamps.	1/2"	1	10
FR6TRBN58		5/8"	1	10
FR6TRBN12M		12mm	1	10
FR6TRBN58M		16mm	1	10

Underfloor Pedestal QuikLock™ Bracket for 6x4 and 4x4 Systems

FR6USB	Used to support the 6x4 and 4x4 systems by attaching to underfloor pedestals. (Contains all necessary hardware.) Use on pedestals up to 1" in diameter. The pre-assembled slide clamps enable fast assembly to channel. Use 7/16" nut driver on slide clamps.	—	1	10
---------------	---	---	---	----

Adjustable Ladder QuikLock™ Bracket for 6x4 and 4x4 Systems

FR6ALB	Used to support the 6x4 and 4x4 systems attaching to any 3/8" (9.5mm) x 1 1/2" (38.1mm) or 3/8" (9.5mm) x 2" (50.8mm) ladder rack rail. Adjustable to nine incremental positions from 4" (101mm) to 12" (305mm) above or below the ladder rack. No threaded rod required. The pre-assembled slide clamps enable fast assembly to channel. Use 7/16" nut driver on slide clamps.	—	1	10
---------------	---	---	---	----

Center Support QuikLock™ Bracket for 6x4 and 4x4 Systems

FR6CS12	Used to support the 6x4 and 4x4 systems from below with new threaded rod. Bracket is secured to threaded rod with two nuts. The pre-assembled slide clamps enable fast assembly to channel. Use 7/16" nut driver on slide clamps. Also can be secured directly to the top of cabinets.	1/2"	1	10
FR6CS58		5/8"	1	10
FR6CS12M		12mm	1	10
FR6CS58M		16mm	1	10

A.
System
Overview

B.
Copper
Systems

C.
Fiber
Optic
Systems

D.
Power
over
Ethernet

E.
Zone
Cabling

F.
Wireless

G.
Outlets

H.
Media
Distribution

I.
Physical
Infrastructure
Management

J.
Overhead &
Underfloor
Routing

K.
Surface
Raceway

L.
Cabinets,
Racks &
Cable
Management

M.
Grounding &
Bonding

N.
Industrial

O.
Labeling &
Identification

P.
Cable
Management
Accessories

Q.
Index

Table continues on page J.34

4x4 and 6x4 FiberRunner® Mounting Brackets (continued)



FR6ACB12
FR6ACB58
FR6ACB12M
FR6ACB58M



FR6TB38
FR6TB12
FR6TB38M
FR6TB12M



FRTBWG12BL



FRTBWG18BL



FRTBWG24BL



FRTBWG30BL

Part Number	Part Description	For Threaded Rod Size	Std. Pkg. Qty.	Std. Ctn. Qty.
-------------	------------------	-----------------------	----------------	----------------

Top Support Adjustable "C" QuikLock™ Bracket for 6x4 and 4x4 Systems

FR6ACB12	Used to support the 6x4 and 4x4 systems from any new threaded rod extending down directly from the ceiling, grid, or ladder rack system. Two position height adjustments to accommodate system with or without hinged cover. Bracket is secured to threaded rod with two nuts. The pre-assembled slide clamps enable fast assembly to channel. Use 7/16" nut driver on slide clamps.	1/2"	1	—
FR6ACB58		5/8"	1	—
FR6ACB12M		12mm	1	—
FR6ACB58M		16mm	1	—

Trapeze QuikLock™ Bracket for 6x4 and 4x4 Systems

FR6TB38	Used to support the 6x4 and 4x4 systems by spanning two threaded rod drops. Can be installed from above or below. Bracket is secured to each threaded rod with two nuts. The pre-assembled slide clamps enable fast assembly to channel. Use 7/16" nut driver on slide clamps.	3/8"	1	10
FR6TB12		1/2"	1	10
FR6TB38M		10mm	1	10
FR6TB12M		12mm	1	10

Wyr-Grid® Mounting Brackets for FiberRunner® System

FRTBWG12BL	FiberRunner® QuikLock™ Threaded Rod Trapeze Bracket for Wyr-Grid® 12" (305mm) width. Used to support FiberRunner® 4x4 and 6x4 Channel above or below the Wyr-Grid® 12" Pathway using the same 1/2" or 12mm threaded rod used to support the WGTB12BL bracket. Hardware for attaching to threaded rod sold separately.	1/2" 12mm	1	10
FRTBWG18BL	FiberRunner® QuikLock™ Threaded Rod Trapeze Bracket for Wyr-Grid® 18" (457mm) width. Used to support FiberRunner® 4x4, 6x4, and 12x4 Channel above or below the Wyr-Grid® 18" Pathway using the same 1/2" or 12mm threaded rod used to support the WGTB18BL bracket. Hardware for attaching to threaded rod sold separately.	1/2" 12mm	1	10
FRTBWG24BL	FiberRunner® QuikLock™ Threaded Rod Trapeze Bracket for Wyr-Grid® 24" (610mm) width. Used to support FiberRunner® 4x4, 6x4, and 12x4 Channel above or below the Wyr-Grid® 24" Pathway using the same 1/2" or 12mm threaded rod used to support the WGTB24BL bracket. Hardware for attaching to threaded rod sold separately.	1/2" 12mm	1	10
FRTBWG30BL	FiberRunner® QuikLock™ Threaded Rod Trapeze Bracket for Wyr-Grid® 30" (762mm) width. Used to support FiberRunner® 4x4, 6x4, 12x4, and 24x4 Channel above or below the Wyr-Grid® 30" Pathway using the same 1/2" or 12mm threaded rod used to support the WGTB30BL bracket. Quick mount clips, FRQMC24-X are not included for installing the 24x4 channel. These must be purchased separately. Hardware for attaching to threaded rod sold separately.	1/2" 12mm	1	10

4x4 and 6x4 FiberRunner® Mounting Brackets (continued)



FR6ACAB



F2PCLB12
F2PCLB58



FRAFC58



FR6LRB



FR6LB



FRRMBNF58

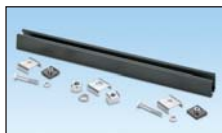

FR4PRB58

Part Number	Part Description	For Threaded Rod Size	Std. Pkg. Qty.	Std. Ctn. Qty.
Adjustable Cabinet QuikLock™ Bracket for 6x4 and 4x4 Systems				
FR6ACAB	Used to support the 6x4 and 4x4 systems attaching to the top of cabinets. Adjustable from 4 1/4" (108mm) to 9" (229mm) allowing runs to be leveled over uneven cabinet heights. Also allows spillouts such as the vertical tee to be positioned directly over cable inlets on cabinet tops. Bracket is secured to the cabinet frame with through bolts (not included). The pre-assembled slide clamps enable fast assembly to channel. Use 7/16" nut driver on slide clamps.	—	1	—
Two-Piece Ladder Rack Bracket for Attaching Threaded Rod to 1 1/2" — 2" Ladder Rack				
F2PCLB12	Two-piece bracket attaches to 3/8" (9.5mm) wide x 1 1/2" (38.1mm) or 3/8" (9.5mm) wide x 2" (50.8mm) ladder rack rail. Bracket halves slide into position and clamp together on the ladder rack rail, which allows for a one-handed assembly of the threaded rod (not included). Contains bracket and hardware for attaching bracket to ladder rack.	1/2"	1	10
F2PCLB58		5/8"	1	10
Two-Piece Framing Clip for Attaching 5/8" Threaded Rod to 2" x 9/16" C-Channel Auxiliary Framing Bars				
FRAFC58	Two-piece framing clip attaches to auxiliary framing bars. Framing clip halves slide into position and interlock on the auxiliary framing bars, allowing easier assembly of the threaded rod to bars. Contains two-piece framing clip and hardware for attaching framing clip to auxiliary framing bars. (5/8" threaded rod not included.)	5/8"	1	10
Ladder Rack QuikLock™ Bracket for 6x4 and 4x4 Systems				
FR6LRB	Used to support the 6x4 and 4x4 systems attaching directly to any 3/8 (9.5mm) x 1 1/2" (38.1mm) or 3/8" (9.5mm) x 2" (50.8mm) ladder rack rail. No threaded rod required. The pre-assembled slide clamps enable fast assembly to channel. Use 7/16" nut driver on slide clamps.	—	1	10
"L" Wall Mount QuikLock™ Bracket for 6x4 and 4x4 Systems				
FR6LB	Used to support the 6x4 and 4x4 systems attaching to a wall or the front or back of an equipment rack. The pre-assembled slide clamps enable fast assembly to channel. Use 7/16" nut driver on slide clamps.	—	1	10
NetFrame®/NetRack™ QuikLock™ Mounting Bracket for 6x4 and 4x4 Systems				
FRRMBNF58	Used to support the 6x4 and 4x4 systems attaching to the top of NetFrame® or NetRack™ Rack. (Contains all necessary mounting hardware.) Bracket accepts 5/8" threaded rod.	5/8"	1	—
4 Post Rack Bracket				
FR4PRB58	Used to support 12x4, 6x4, and 4x4 systems attaching to the top of the 19" wide version of the Panduit NF4PR84 4 post rack. Contains all hardware required to assemble bracket to the top of the 4 post rack. Bracket accepts 5/8" threaded rod (not included).	5/8"	1	—

Adapters to Other Systems



FRADC6X4



FRADC4X4BL



FADC4X4



FRTEL6



FRTEL4



FRWBS68

Part Number	Part Description	Couplers Required	Std. Pkg. Qty.	Std. Ctn. Qty.
-------------	------------------	-------------------	----------------	----------------

Adapter from 12x4 FiberRunner® System to ADC 12x4 FiberGuide*

FRADC12X4BL	Fitting that transitions from ADC's 12x4 FiberGuide* System to 12x4 FiberRunner® System. Fitting has a black finish and is made from metal. Attachment hardware is included.	(1 pc.) FRBC12X4YL	1	5
--------------------	--	-----------------------	---	---

Adapter from 6x4 FiberRunner® System to ADC 6x4 FiberGuide*

FRADC6X4YL	Fitting that transitions from ADC's 6x4 FiberGuide* System to 6x4 FiberRunner® System. Bolts release using 3/8" nut driver to allow coupler to be removed, if necessary.	—	1	5
-------------------	--	---	---	---

Adapter from 4x4 FiberRunner® System to ADC 4x4 FiberGuide*

FRADC4X4BL	Fitting that transitions from ADC's 4x4 FiberGuide* System to 4x4 FiberRunner® System. Fitting has a black finish and is made from metal. Attachment hardware is included.	(1 pc.) FRBC4X4YL	1	5
-------------------	--	----------------------	---	---

Adapter from 4x4 Fiber-Duct™ System to ADC 4x4 FiberGuide*

FADC4X4	Fitting that transitions from ADC's 4x4 FiberGuide* Fiber Cable Management System to 4x4 Fiber-Duct™ System. Fitting has a black finish and is made from metal. Attachment hardware is included.	—	1	10
----------------	--	---	---	----

Adapter from 6x4 FiberRunner® System to Telect 6x4 WaveTrax***

FRTEL6	Fitting that transitions from Telect's 6x4 WaveTrax*** System to 6x4 FiberRunner® System. Fitting has a black finish and is made from metal. Attachment hardware is included.	(1 pc.) FRBC6X4YL	1	5
---------------	---	----------------------	---	---

Adapter from 4x4 FiberRunner® System to Telect 4x4 WaveTrax***

FRTEL4	Fitting that transitions from Telect's 4x4 WaveTrax*** System to 4x4 FiberRunner® System. Fitting has a black finish and is made from metal. Attachment hardware is included.	(1 pc.) FRBC4X4YL	1	5
---------------	---	----------------------	---	---

Adapter from 6x4 FiberRunner® System to Warren & Brown 8x4 Lightpaths**

FRWBS68	Fitting that transitions from Warren & Brown 8x4 Lightpaths** System to 6x4 FiberRunner® System. Fitting has a black finish and is made from metal. Attachment hardware is included.	(1 pc.) FRBC6X4YL	1	5
----------------	--	----------------------	---	---

*FiberGuide is a registered trademark of ADC Telecommunications, Inc.

**Lightpaths is a trademark of Warren & Brown Technologies Pty. Ltd.

***WaveTrax is a trademark of Telect, Inc.

Adapters to Other Systems (continued)



FRNWT12



FRNWT128



FRTYT68



FTDNS4X4

Part Number	Part Description	Couplers Required	Std. Pkg. Qty.	Std. Ctn. Qty.
Adapter from 12x4 FiberRunner® System to Various 12x4 System Channels				
FRNWT12	Fitting that transitions from Tyton 12x4 Lightguide* Channel, Newton** 12x4 Channel, or Ditel 12x4 Lightrax*** Channel to 12x4 FiberRunner® System. Fitting has a black finish and is made from metal. Attachment hardware is included.	(1 pc.) FRBC12X4YL	1	—
Adapter from 12x4 FiberRunner® System to Various 8x4 System Channels				
FRNWT128	Fitting that transitions from Tyton 8x4 Lightguide* Channel, Newton** 8x4 Channel, or Ditel 8x4 Lightrax*** Channel to 12x4 FiberRunner® System. Fitting has a black finish and is made from metal. Attachment hardware is included.	(1 pc.) FRBC12X4YL	1	—
Adapter from 6x4 FiberRunner® System to Various 8x4 System Channels				
FRTYT68	Fitting that transitions from Tyton 8x4 Lightguide* Channel, Newton** 8x4 Channel, or Ditel 8x4 Lightrax*** Channel to 6x4 FiberRunner® System. Fitting has a black finish and is made from metal. Attachment hardware is included.	(1 pc.) FRBC6X4YL	1	5
Adapter from 4x4 Fiber-Duct™ System to Various 4x4 Systems				
FTDNS4X4YL	Fitting that transitions from various 4x4 systems to 4x4 Fiber-Duct™ System. Attachment hardware is included.	—	1	5

*Lightguide is a trademark of the Hellerman Tyton Corporation.

**Newton is a tradename of Newton Instrument Company, Inc.

***Lightrax is a trademark of Tyco Electronics Corporation.

A.
System
Overview

B.
Copper
Systems

C.
Fiber
Optic
Systems

D.
Power
over
Ethernet

E.
Zone
Cabling

F.
Wireless

G.
Outlets

H.
Media
Distribution

I.
Physical
Infrastructure
Management

J.
Overhead &
Underfloor
Routing

K.
Surface
Raceway

L.
Cabinets,
Racks &
Cable
Management

M.
Grounding &
Bonding

N.
Industrial

O.
Labeling &
Identification

P.
Cable
Management
Accessories

Q.
Index

4x4 Routing System Roadmap

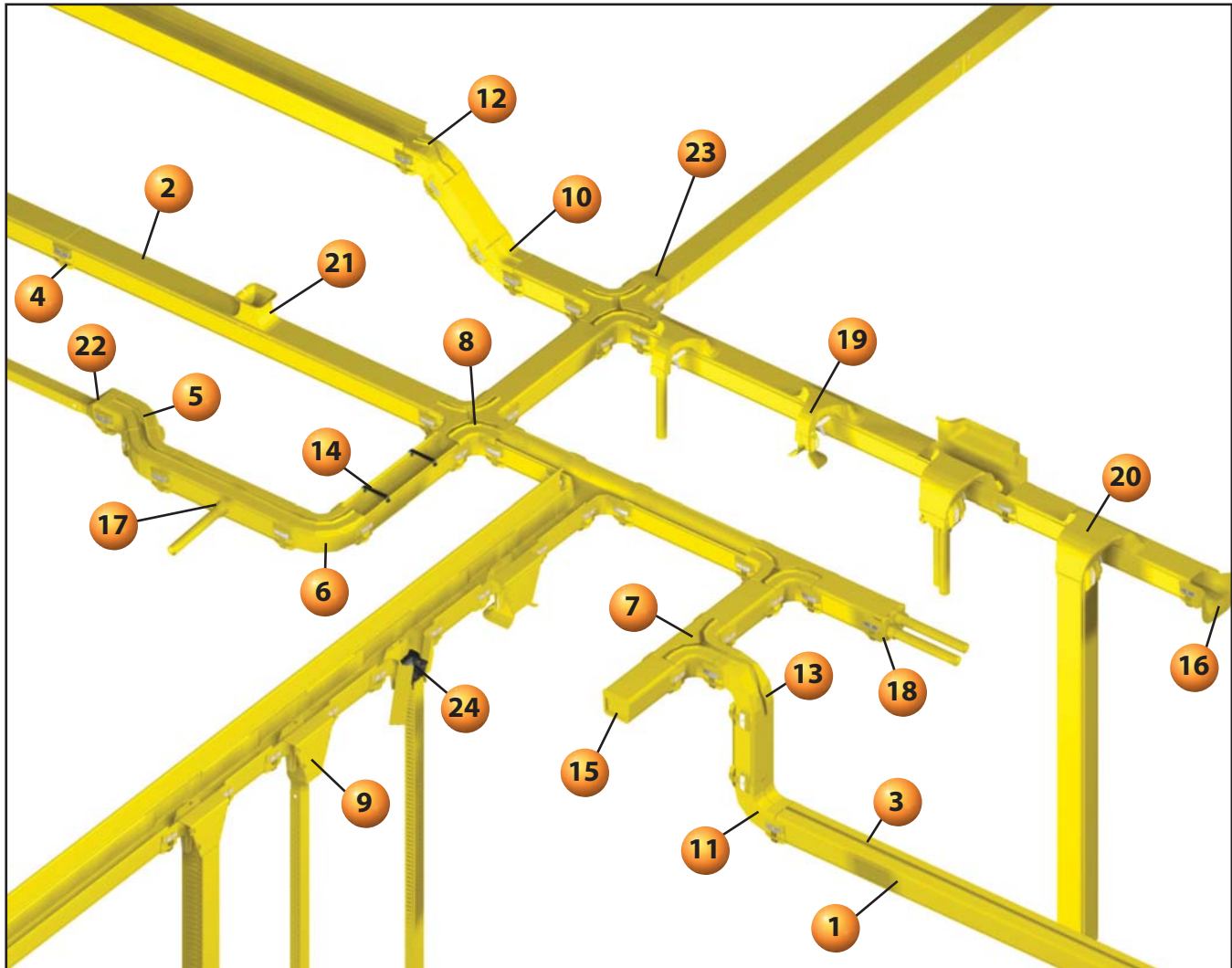

4x4 and 6x4 FiberRunner® Mounting Brackets

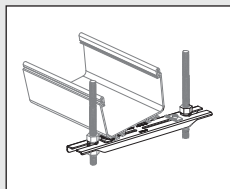

**FR6TB38 - Trapeze
QuikLock™ Bracket**
(page J.34)

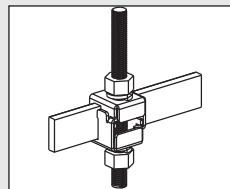

**F2PCLB - Two-Piece
Ladder Rack Bracket
for Attaching
Threaded Rod to
1 1/2" - 2" Ladder Rack**
(page J.35)

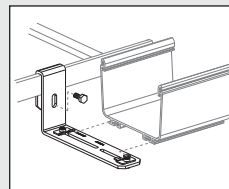

**FR6LRB - Ladder Rack
QuikLock™ Bracket**
(page J.35)

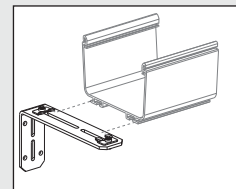

**FR6LB - "L" Wall
Mount QuikLock™
Bracket** (page J.35)

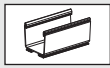

- 1** FR4X4**6 – 4x4 FiberRunner® Channel (page J.40)

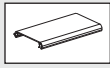

- 2** FRHC4**6 – 4x4 Snap-On Hinged Cover (page J.40)

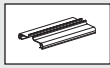

- 3** FRSHC4**6 – 4x4 Split Hinged Cover (page J.40)



- 4** FRBC4X4** – 4x4 QuikLock™ Coupler (page J.41)

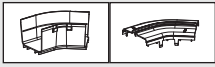

- 5** FRH454X4** – 4x4 Horizontal 45° Angle Fitting and FRH45SC4** Optional Split Cover (page J.41)

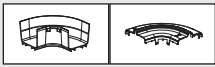

- 6** FRRA4X4** – 4x4 Horizontal Right Angle Fitting and FRRASC4** – Optional Split Cover (page J.41)

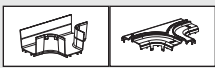

- 7** FRT4X4** – 4x4 Horizontal Tee Fitting and FRTSC4** – Optional Split Cover (page J.42)

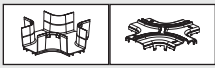

- 8** FRFWC4X4** – 4x4 4-Way Cross Fitting and FRFWCSC4** – Optional Split Cover (page J.42)



- 9** FRVT4X4** – 4x4 QuikLock™ Vertical Tee (page J.44)



- 10** FRIV454X4** – 4x4 Inside Vertical 45° Angle Fitting (page J.42)



- 11** FRIVRA4X4** – 4x4 Inside Vertical 90° Angle Fitting (page J.42)

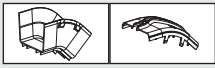

- 12** FROV454X4** – 4x4 Outside Vertical 45° Angle Fitting and FROV45SC4** – Optional Split Cover (pages J.42 and J.43)

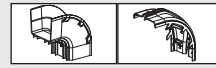

- 13** FROVRA4X4** – 4x4 Outside Vertical Right Angle Fitting and FROVRASC4** – Optional Split Cover (page J.43)

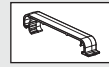

- 14** FRCR4BL-X – Cable Retainer for 4x4 System (page J.40)



- 15** FREC4X4** – 4x4 End Cap Fitting (page J.42)

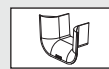

- 16** FRTR4X4** – 3-Sided BRC Trumpet Spillout for 4x4 FiberRunner® Exit (page J.46)

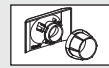

- 17** FR1.5IDE** – 1-Port Spillout Side Exit to 1.5" (38mm) Inside Diameter Corrugated Tubing (page J.46)

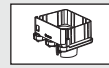

- 18** FRIDT4X4** – 2-Port Spillout to 1.5" (38mm) Inside Diameter Corrugated Tubing (page J.46)

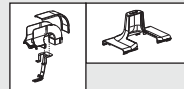

- 19** FRSPJ2X2** – Spill-Over Junction with 2x2 Exit and FRSPJC24** – Optional Cover for 4x4 System (page J.45)

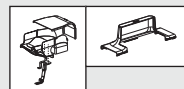

- 20** FRSPJ4X4** – Spill-Over Junction with 4x4 Exit and FRSPJC44** – Optional Cover for 4x4 System (pages J.45 and J.46)



- 21** FRUPS4X4** – 4x4 Up Spout (page J.46)



- 22** FRRF4FD2** – 4x4 FiberRunner® System to 2x2 Reducer Fitting with Cover (page J.43)

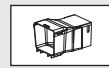

- 23** FRRF4FD4** – 4x4 FiberRunner® System to 4x4 Fiber-Duct™ Reducer Fitting with Cover (page J.43)



- 24** FRLPR42BL – Low Profile Reducer 4x4 to 2x2 for Vertical Tee (page J.44)

**Available colors include: YL (Yellow), OR (Orange), and BL (Black).
Note: Additional 6x4 and 4x4 bracket applications, see page J.23.



4x4 FiberRunner® Routing System

Cable Fills for 4x4 FiberRunner® Cable Routing System

The maximum amounts may vary according to the cable fill installation methods, straightness of cables, etc.

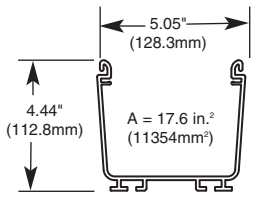

4x4 FiberRunner® Cable Routing System								
Fill/Pile Up	Internal Area (in ²)	Diameter 1.6mm 0.063"	Diameter 2.0mm 0.079"	Diameter 3.0mm 0.118"	Fiber Optic Ribbon Interconnect Cable Diameter 5.20mm 0.205"	Category 6A (SD) Diameter 6.1mm 0.240"	Category 6A Diameter 7.6mm 0.300"	Category 6 Diameter 6.1mm 0.240"
40% Fill								
2" Pile Up	8.9	1142	731	325	108	79	50	79
3" Pile Up	13.58	1743	1116	496	165	120	77	120
4" Pile Up	17.6	2259	1446	643	213	156	100	156
50% Fill								
2" Pile Up	8.9	1428	914	406	135	98	63	98
3" Pile Up	13.58	2179	1394	620	206	150	96	150
4" Pile Up	17.6	2824	1807	803	267	195	124	195
60% Fill								
2" Pile Up	8.9	1714	1097	487	162	118	76	118
3" Pile Up	13.58	2615	1673	744	247	180	115	180
4" Pile Up	17.6	3389	2169	964	320	233	149	233

Channel cutting instructions: For optimum results, use a miter box and saw. For larger quantities use a plastic cutting saw blade for clean, burr-free cuts. Recommend: Carbide 80T and 100T; .090" thickness, .125" kerf.

The above cable diameters represent the nominal Panduit cable diameter per performance level. For specific cable fill information based on specific part numbers, please contact Panduit customer service.

4x4 FiberRunner® Routing System – Channel and Covers

- Robust 4x4 system ideal for use with smaller cable counts
- Multiple spillover options provide versatility to mate to various equipment and rack configurations
- QuikLock™ Couplers and Brackets reduce system installation time dramatically
- Channel, covers, fittings and other non-metallic system components made from V-0 flame class rated material
- Compatible with all sizes of Panduit® FiberRunner® and Panduit® Fiber-Duct™ Routing Systems, cable management, and racks
- Compliant with the applicable tests in Telcordia GR-63-CORE Network Equipment Building Systems (NEBS) Level 3

Part Number	Part Description	Std. Pkg. Qty.	Std. Ctn. Qty.
4x4 FiberRunner® Channel			
FR4X4YL6	Used to carry the cables horizontally throughout the system. Accepts hinged cable retainers FRCR4BL-X, hinged cover FRHC4YL6, or split hinged cover FRSHC4YL6. Use QuikLock™ Coupler FRBC4X4YL to attach channel and/or fittings.	6	36
4x4 Snap-On Hinged Cover			
FRHC4YL6	Optional snap-on hinged cover for channel FR4X4YL6. Hinge feature enables positioning of cover at angles between 30° to 90°.	6	36
4x4 Split Hinged Cover			
FRSHC4YL6	Optional split hinged cover for the channel FR4X4YL6. Creates radiused 3/4" (19mm) opening for easy access to add or remove cables. Snap-on hinge feature enables positioning of cover at angles between 30° and 90°.	6	36
Cable Retainer for 4x4 System			
FRCR4BL-X	Cable retainer holds cable in the channel when cover is not used. Install anywhere on channel, near the coupler or every 18" (457mm). Black color only.	10	100

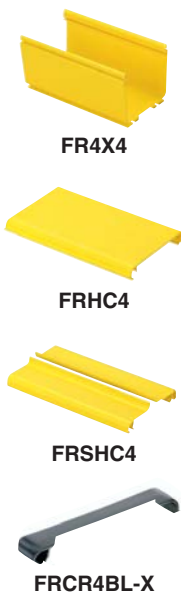

For other colors replace YL (Yellow) with OR (Orange) or BL (Black).
 Order number of feet required, in multiples of standard 6' length increments.
 Order number of cable retainers required, in multiples of Standard Package Quantity.

4x4 FiberRunner® QuikLock™ Coupler

- Pre-assembled to provide fast mechanical assembly of components
- No tools required for installation; bolts loosen for component disassembly



Part Number	Part Description	Std. Pkg. Qty.	Std. Ctn. Qty.
FRBC4X4YL	Pre-assembled coupler quickly joins two sections of channel and/or fittings. Mechanically attaches without tightening bolts. Bolts release using 3/8" nut driver to allow coupler to be removed if necessary.	1	5

For a bulk package of 20 couplers, order FRBC4X4YL-E.
For other colors replace suffix YL (Yellow) with OR (Orange) or BL (Black).

4x4 FiberRunner® System Fittings

- Minimum 2" (50.8mm) bend radius control fittings
- Optional split covers snap onto each fitting
- Protects against signal loss and performance degradation
- Covers feature 3/4" (19mm) gap to allow cable to be laid in
- Assemble using FRBC QuikLock™ Couplers

Part Number	Part Description	Couplers Required	Std. Pkg. Qty.	Std. Ctn. Qty.
4x4 Horizontal Right Angle Fitting				
FRRA4X4YL	Attaches to 4x4 channel and/or fitting to create a 90° horizontal turn from a straight horizontal run. Accepts optional split cover FRRASC4YL.	(2 pcs.) FRBC4X4YL	1	5



FRRA4X4

Split Cover for 4x4 Horizontal Right Angle Fitting				
FRRASC4YL	Optional split cover for the horizontal right angle fitting FRRA4X4YL. Snap-on feature allows cover to be installed and removed with no tools required. Creates radiused 3/4" (19mm) opening for easy access to add or remove cables.	—	1	5



FRRASC4

4x4 Horizontal 45° Angle Fitting				
FRH454X4YL	Attaches to 4x4 channel and/or fittings to create a 45° horizontal turn from a straight horizontal run. Accepts optional split cover FRH45SC4YL.	(2 pcs.) FRBC4X4YL	1	5



FRH454X4

Split Cover for 4x4 Horizontal 45° Angle Fitting				
FRH45SC4YL	Optional split cover for the horizontal 45° angle fitting FRH454X4YL. Snap-on feature allows cover to be installed and removed with no tools required. Creates radiused 3/4" (19mm) opening for easy access to add or remove cables.	—	1	5



FRH45SC4

For other colors replace suffix YL (Yellow) with OR (Orange) or BL (Black).

Table continued on page J.42

4x4 FiberRunner[®] System Fittings (continued)**FRT4X4****FRTSC4****FRFWC4X4****FRFWCSC4****FREC4X4****FRIVRA4X4****FRIV454X4****FROV454X4**

Part Number	Part Description	Couplers Required	Std. Pkg. Qty.	Std. Ctn. Qty.
-------------	------------------	-------------------	----------------	----------------

4x4 Horizontal Tee Fitting

FRT4X4YL	Attaches to 4x4 channel and/or fittings to create a 90° horizontal branch from straight horizontal runs. Accepts optional split cover FRTSC4YL.	(3 pcs.) FRBC4X4YL	1	5
-----------------	---	-----------------------	---	---

Split Cover for 4x4 Horizontal Tee Fitting

FRTSC4YL	Optional split cover for the horizontal tee fitting FRT4X4YL. Snap-on feature allows cover to be installed and removed with no tools required. Creates radiused 3/4" (19mm) opening for easy access to add or remove cables.	—	1	5
-----------------	--	---	---	---

4x4 Four Way Cross Fitting

FRFWC4X4YL	Attaches to 4x4 channel and/or fittings to create a horizontal four way cross intersection. Accepts optional split cover FRFWCSC4YL.	(4 pcs.) FRBC4X4YL	1	5
-------------------	--	-----------------------	---	---

Split Cover for 4x4 Four Way Cross Fitting

FRFWCSC4YL	Optional split cover for the four way cross fitting FRFWC4X4YL. Snap-on feature allows cover to be installed and removed with no tools required. Creates radiused 3/4" (19mm) opening for easy access to add or remove cables.	—	1	5
-------------------	--	---	---	---

4x4 End Cap Fitting

FREC4X4YL	Used for closing off open ends of the channel or fittings. No coupler required. Push-on installation.	—	1	5
------------------	---	---	---	---

4x4 Inside Vertical 90° Angle Fitting

FRIVRA4X4YL	Attaches to 4x4 channel and/or fittings to create a 90° upward angle from a horizontal run. Used with outside vertical 90° angle fitting FROVRA4X4YL to change level of a straight horizontal run. Includes split cover.	(2 pcs.) FRBC4X4YL	1	5
--------------------	--	-----------------------	---	---

4x4 Inside Vertical 45° Angle Fitting

FRIV454X4YL	Attaches to 4x4 channel and/or fittings to create a 45° upward angle from a horizontal run. Used with outside vertical 45° angle fitting FROV454X4YL to change level of a straight horizontal run. Includes split cover.	(2 pcs.) FRBC4X4YL	1	5
--------------------	--	-----------------------	---	---

4x4 Outside Vertical 45° Angle Fitting

FROV454X4YL	Attaches to 4x4 channel and/or fittings to create a 45° downward angle from a horizontal run. Used with inside vertical 45° angle fitting FRIV454X4YL to change level of a straight horizontal run. Accepts optional split cover FROV45SC4YL.	(2 pcs.) FRBC4X4YL	1	5
--------------------	---	-----------------------	---	---

For other colors replace suffix YL (Yellow) with OR (Orange) or BL (Black).

4x4 FiberRunner® System Fittings (continued)



FROV45SC4



FROVRA4X4



FROVRASC4



FRRF6FR4



FRRF6FR4SC



FRRF4FD2



FRRF4FD4

Part Number	Part Description	Couplers Required	Std. Pkg. Qty.	Std. Ctn. Qty.
Split Cover for 4x4 Outside Vertical 45° Angle Fitting				
FROV45SC4YL	Optional split cover for the outside vertical 45° angle fitting FROV454X4YL. Snap-on feature allows cover to be installed and removed with no tools required. Creates radiused 3/4" (19mm) opening for easy access to add or remove cables.	—	1	5
4x4 Outside Vertical Right Angle Fitting				
FROVRA4X4YL	Attaches to 4x4 channel and/or fittings to create a 90° vertical turn down from a straight horizontal run. Accepts optional split cover FROVRASC4YL.	(2 pcs.) FRBC4X4YL	1	5
Split Cover for 4x4 Outside Vertical Right Angle Fitting				
FROVRASC4YL	Optional split cover for the outside vertical right angle fitting FROVRA4X4YL. Snap-on feature allows cover to be installed and removed with no tools required. Creates radiused 3/4" (19mm) opening for easy access to add or remove cables.	—	1	5
6x4 to 4x4 FiberRunner® Reducer Fitting				
FRRF6FR4YL	Attaches any 6x4 FiberRunner® Fitting or Channel to any 4x4 FiberRunner® Fitting or Channel. Accepts split cover FRRF6FR4SCYL.	(1 pc.) FRBC6X4YL (1 pc.) FRBC4X4YL	1	5
Split Cover for 6x4 to 4x4 FiberRunner® Reducer Fitting				
FRRF6FR4SCYL	Optional split cover for the 6x4 FiberRunner® to 4x4 FiberRunner® Reducer Fitting FRRF6FR4YL. Snap-on feature allows cover to be installed and removed with no tools required. Creates radiused 3/4" (19mm) opening for easy access to add or remove cables.	—	1	5
4x4 FiberRunner® to 2x2 Reducer Fitting with Cover				
FRRF4FD2YL	Attaches any 4x4 FiberRunner® Fitting or Channel to the 2x2 Fiber-Duct™ Channel, S2X2YL6 or E2X2YL6 or 2x2 FiberRunner® Channel, HS2X2YL6 or H2X2YL6. Note: Attachment to 2x2 FiberRunner® Channel requires a QuikLock™ Coupler FBC2X2YL. Includes solid cover.	(1 pc.) FRBC4X4YL	1	5
4x4 FiberRunner® to 4x4 Fiber-Duct™ Reducer Fitting with Cover				
FRRF4FD4YL	Attaches any 4x4 FiberRunner® Fitting or Channel to the 4x4 Fiber-Duct™ Channel, S4X4YL6 or E4X4YL6. Includes solid cover.	(1 pc.) FRBC4X4YL	1	5

For other colors replace suffix YL (Yellow) with OR (Orange) or BL (Black).

4x4 FiberRunner[®] System Spillouts

- Spill-overs allow safe transition from horizontal to vertical runs
- 2" (50.8mm) bend radius control
- Transition to channel, slotted channel, and corrugated loom tubing
- Spill-over junction fittings can be retro-fitted to existing horizontal runs



FRVT4X4



FTR4X4



FIDT4X4BL



FRHD4KT



TRC4HDBL



FRLPR42BL

Part Number	Part Description	Couplers Required	Std. Pkg. Qty.	Std. Ctn. Qty.
-------------	------------------	-------------------	----------------	----------------

4x4 QuikLock™ Vertical Tee

FRVT4X4YL	Attaches to 4x4 channel and/or fittings to create a 90° vertical drop from a horizontal run. Hinged door included. Accepts FTR4X4YL, FIDT4X4BL, S4X4YL6 or E4X4YL6 directly. Accepts optional snap-on cover FRHC4YL6 in conjunction with channel.	(2 pcs.) FRBC4X4YL	1	5
------------------	---	-----------------------	---	---

3-Sided Vertical Tee Trumpet Spillout

FTR4X4YL	Used to limit the bend radius of the cable to 2" (50.8mm) when exiting from a 4x4 or 6x4 FiberRunner [®] Vertical Tee and 4x4 Fiber-Duct™ Fittings.	—	1	5
-----------------	--	---	---	---

2-Port Spillout to 1.5" (38mm) Inside Diameter Corrugated Tubing

FIDT4X4BL	Used to route cable into one or two pieces of 1.5" (38mm) diameter split corrugated tubing. Used with FRVT6X4YL, FRVT4X4YL, or FVT4X4YL. Securely holds corrugated split tubing to ensure system integrity and easy access to add or remove cables. Black color only.	—	1	5
------------------	---	---	---	---

4x4 Hinged Duct Vertical Cable Manager Kit

FRHD4KTYL	Provides secure, accessible route for cables spilling out from vertical tee to rack mounted equipment. Kit includes 6' length of 4x4 capacity hinged duct, 6' length of 4x4 hinged duct cover, one end cap for 4x4 hinged duct, three FZBA1.5X4 adjustable "Z" brackets, an adapter fitting, six WR4-C wire retainers and all required mounting hardware. Attaches directly to 6x4 and 4x4 vertical tee exit or FRLPR64 low profile reducer.	—	1	—
------------------	--	---	---	---

4x4 Hinged Duct Bend Radius Control Trumpet

TRC4HDBL	Bend radius control trumpet for exiting at the sidewall of 4" wall heights of type H hinged cover wiring duct channels. Maintains 1" (25.4mm) bend radius control. Black color only.	—	1	—
-----------------	--	---	---	---

Low Profile Reducer 4x4 to 2x2 for Vertical Tee

FRLPR42BL	Assembled into the 6x4 vertical tee FRVT6X4YL or 4x4 vertical tee FRVT4X4YL with an audible snap, the FRLPR42BL allows for the transition to 2x2 FiberRunner [®] or 2x2 Fiber-Duct™ Channel with minimal space required. No tools required for assembly. Black color only.	—	1	5
------------------	---	---	---	---

For other colors replace suffix YL (Yellow) with OR (Orange) or BL (Black).

4x4 FiberRunner® System Spillouts (continued)



FRSPJ2X2



FRSPJC24



FTR2X2



FIDT2X2



FRHD2KT



TRC2HDBL



FRSPJ4X4

Part Number	Part Description	Couplers Required	Std. Pkg. Qty.	Std. Ctn. Qty.
Spill-Over Junction with 2x2 Exit				
FRSPJ2X2YL	Assembles onto 4x4, 6x4, 12x4, or 24x4 FiberRunner® Channel, spilling over the side into a 2x2 vertical exit. Requires coupler to attach 2x2 FiberRunner® and fittings to the vertical exit. Mounts directly to existing installation with no alteration required. Mounting hardware provided for secure attachment.	(1 pc.) FBC2X2YL	1	—
Cover for Spill-Over Junction with 2x2 Exit for 4x4 Channel				
FRSPJC24YL	Used to fully enclose 4x4 channel in conjunction with the spill-over junction FRSPJ2X2YL. Cover snaps onto the channel base. Hinged feature allows easy access to add or remove cables.	—	1	5
3-Sided BRC Trumpet Spillout for 2x2 Exit				
FTR2X2YL	Used to limit the bend radius of the cable to 2" (50.8mm) when exiting from a spill-over junction with a 2x2 exit or from 2x2 Fiber-Duct™ Channel. Securely holds split corrugated tubing to ensure system integrity and easy access to add or remove cables.	(1 pc.) FBC2X2YL	1	5
1-Port Spillout to 1.5" (38mm) Inside Diameter Corrugated Tubing				
FIDT2X2YL	Used to route cable into one piece of 1.5" (38mm) diameter split corrugated tubing. Used with a spill-over junction with a 2x2 exit, 2x2 Fiber-Duct™ Fittings, and the 2x2 FiberRunner® Hinged Channel. Securely holds split corrugated tubing to ensure system integrity and easy access to add or remove cables.	(1 pc.) FBC2X2YL	1	5
2x2 Hinged Duct Vertical Cable Manager Kit				
FRHD2KTYL	Provides secure, accessible route for cables spilling out from a vertical tee or spill-over junction to rack mounted equipment. Kit includes 6' length of 2x2 FiberRunner® Hinged Channel H2X2YL6, 6' length of 2x2 snap-on hinged cover HC2YL6, four adjustable "Z" brackets FZBA1.5X4, one FiberRunner® 2x2 End Cap FHDEC2X2YL, six hinged duct 2" wire retainers WR2H-C and all required mounting hardware. Attaches to 2x2 vertical tee exit or spill-over junction with a 2x2 exit with a 2x2 QuikLock™ Coupler FBC2X2YL. Also attaches directly to 4x4 or 6x4 vertical tee exits with low profile reducer FRLPR42BL.	—	1	—
2x2 FiberRunner® Bend Radius Control Trumpet				
TRC2HDBL	Bend radius control trumpet for exiting at the sidewall of 2" wall heights of type H hinged cover wiring duct channels. Maintains 1" (25.4mm) bend radius control. Black color only.	—	1	10
Spill-Over Junction with 4x4 Exit				
FRSPJ4X4YL	Assembles onto 4x4, 6x4, 12x4, or 24x4 FiberRunner® Channel, spilling over the side into a 4x4 vertical exit. Requires coupler to attach 4x4 FiberRunner® Channel and fittings to the vertical exit. Mounts directly to existing installation with no alteration required. Mounting hardware provided for secure attachment.	(1 pc.) FRBC4X4YL	1	—

For other colors replace suffix YL (Yellow) with OR (Orange) or BL (Black).

Table continued on page J.46

4x4 FiberRunner[®] System Spillouts (continued)**FRSPJC44****FRTR4X4****FRTR4X4****FRIDT4X4****FR1.5IDE****FRUPS4X4**

Part Number	Part Description	Couplers Required	Std. Pkg. Qty.	Std. Ctn. Qty.
-------------	------------------	-------------------	----------------	----------------

Cover for Spill-Over Junction with 4x4 Exit for 4x4 Channel

FRSPJC44YL	Used to fully enclose 4x4 channel in conjunction with the spill-over junction FRSPJ4X4YL. Cover snaps onto the channel base. Hinged feature allows easy access to add or remove cables.	—	1	5
-------------------	---	---	---	---

3-Sided BRC Trumpet Spillout for 4x4 FiberRunner[®] Exit

FRTR4X4YL	Used to limit the bend radius of the cable to 2" (50.8mm) when exiting from 4x4 FiberRunner [®] Channel or a 4x4 FiberRunner [®] Horizontal Tee.	(1 pc.) FRBC4X4YL	1	5
------------------	--	----------------------	---	---

2-Port Spillout to 1.5" (38mm) Inside Diameter Corrugated Tubing

FRIDT4X4YL	Used to route cable into one or two pieces of 1.5" (38mm) diameter split corrugated tubing. Requires coupler to be used with 4x4 FiberRunner [®] Fitting. Used with any 4x4 FiberRunner [®] Fitting. Securely holds corrugated split tubing to ensure system integrity and easy access to add or remove cables.	(1 pc.) FRBC4X4YL	1	5
-------------------	---	----------------------	---	---

1-Port Spillout Side Exit to 1.5" (38mm) Inside Diameter Corrugated Tubing

FR1.5IDEYL	Used to route cable into 1.5" (38mm) diameter split corrugated tubing directly through a hole cut in the side wall of the 4x4, 6x4, and 12x4 FiberRunner [®] Channel or 4x4 Fiber-Duct [™] Channel. Provides 1" (25.4mm) bend radius control at the exit. Securely holds split corrugated tubing to ensure system integrity and easy access to add or remove cables. Includes drilling template.	—	1	5
-------------------	--	---	---	---

4x4 Up Spout

FRUPS4X4YL	Allows cable to be directed upward out of the channel deployed directly below racks and cabinets in underfloor installations. Provides 2" (50.8mm) bend radius. Snaps directly onto the channel and can be positioned to allow cables to be laid in. A 1" (25.4mm) top bezel is included. Other fittings can be installed for specific applications including FTR4X4YL and FIDT4X4BL.	—	1	5
-------------------	---	---	---	---

For other colors replace suffix YL (Yellow) with OR (Orange) or BL (Black).

FiberRunner® Accessories



FR38DR



FR716DR



FR516DR



FRUIB-X



FRSSM2



FRSTRCLIP



FRTBKT-X

Part Number	Part Description	For Threaded Rod Size	Std. Pkg. Qty.	Std. Ctn. Qty.
3/8" Nut Driver				
FR38DR	Used to disassemble 4x4, 6x4, and 12x4 FiberRunner® QuikLock™ Couplers when required.	—	1	10
7/16" Nut Driver				
FR716DR	7/16" nut driver for use with the FiberRunner®, GridRunner™, and Wyr-Grid™ Systems.	—	1	10
5/16" Nut Driver				
FR516DR	Used to disassemble 2x2 FiberRunner® QuikLock™ Couplers when required.	—	1	10
Universal Innerduct Bracket				
FRUIB-X	Used to secure any size corrugated tubing or innerduct to any surface including equipment racks and channel or fittings. Two 1/4" (6.3mm) holes must be drilled through to secure brackets.	—	10	100
Slack Spool Manager with 2.37" Bend Radius Diameter				
FRSSM2	The slack spool manager can be mounted in 12x4, 6x4, and 4x4 FiberRunner® Channels and in 4x4 Fiber-Duct™ Channel to create an in-channel slack management. It can be deployed in a vertical or horizontal channel run and can withstand a 20 lb. load without pulling away from the base. Mounting fasteners are included.	—	1	5
Strut Clip Kit				
FRSTRCLIP	Strut mounting clip assembly allows FiberRunner® Channel to be attached directly to standard 1 5/8" wide strut structures. Contains two clips and all hardware for assembly. Bolts release with 7/16" nut driver.	—	1	10
1/4" T-Bolt Kit				
FRTBKT-X	T-bolts can be used for additional attachment when securing FiberRunner® Channel to mounting brackets. For example, a T-bolt can be inserted thru a 12x4 mounting bracket and positioned within the center rib structure on the underside of 12x4 channel. By tightening the nut, the 12x4 channel is more securely fastened to the mounting bracket.	—	10	100

Table continued on page J.48

FiberRunner® Accessories (continued)



FRQMC-X

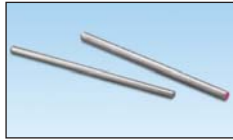

TR1-12-X
TR1-58-X



TRC18FR-X8Y



CLT150F-X3

Part Number	Part Description	For Threaded Rod Size	Std. Pkg. Qty.	Std. Ctn. Qty.
-------------	------------------	-----------------------	----------------	----------------

FiberRunner® Quick Mount Clips

FRQMC-X	Used wherever additional FiberRunner® Slide Clamps would be helpful. For example, use on 12x4 FiberRunner® QuikLock™ Brackets to accommodate dual runs of 6x4 or 4x4 FiberRunner® Channel.	—	10	100
----------------	--	---	----	-----

Threaded Rod in One Foot Lengths

TR1-12-X	Threaded rod can be used with various mounting brackets. Length = 12" (305mm).	1/2"	10	—
TR1-58-X	Threaded rod can be used with various mounting brackets. Length = 12" (305mm).	5/8"	10	—

Threaded Rod Cover

TRC18FR-X8Y	Used to protect cabling from threaded rod. Vertical slit allows easy installation. For indoor use only. Gray.	1/2" – 5/8"	10	100
TRC18FR-X20Y	Used to protect cabling from threaded rod. Vertical slit allows easy installation. Black.	1/2" – 5/8"	10	100

Slit Corrugated Loom Tubing

CLT150F-X3*	Slit corrugated loom tubing provides a vertical pathway as cables transfer from the FiberRunner® Fitting to the equipment below. Inside diameter is 1.48" (37.6mm) and outside diameter 1.73" (43.9mm). Sold in 10' rolls.	—	1	—
--------------------	--	---	---	---

*For other colors replace suffix X3 (Orange) with X4 (Yellow) or X20 (Black).

NOTES

A.
System
OverviewB.
Copper
SystemsC.
Fiber
Optic
SystemsD.
Power
over
EthernetE.
Zone
CablingF.
WirelessG.
OutletsH.
Media
DistributionI.
Physical
Infrastructure
ManagementJ.
Overhead &
Underfloor
RoutingK.
Surface
RacewayL.
Cabinets,
Racks &
Cable
ManagementM.
Grounding &
BondingN.
IndustrialO.
Labeling &
IdentificationP.
Cable
Management
AccessoriesQ.
Index

2x2 Routing System Roadmap

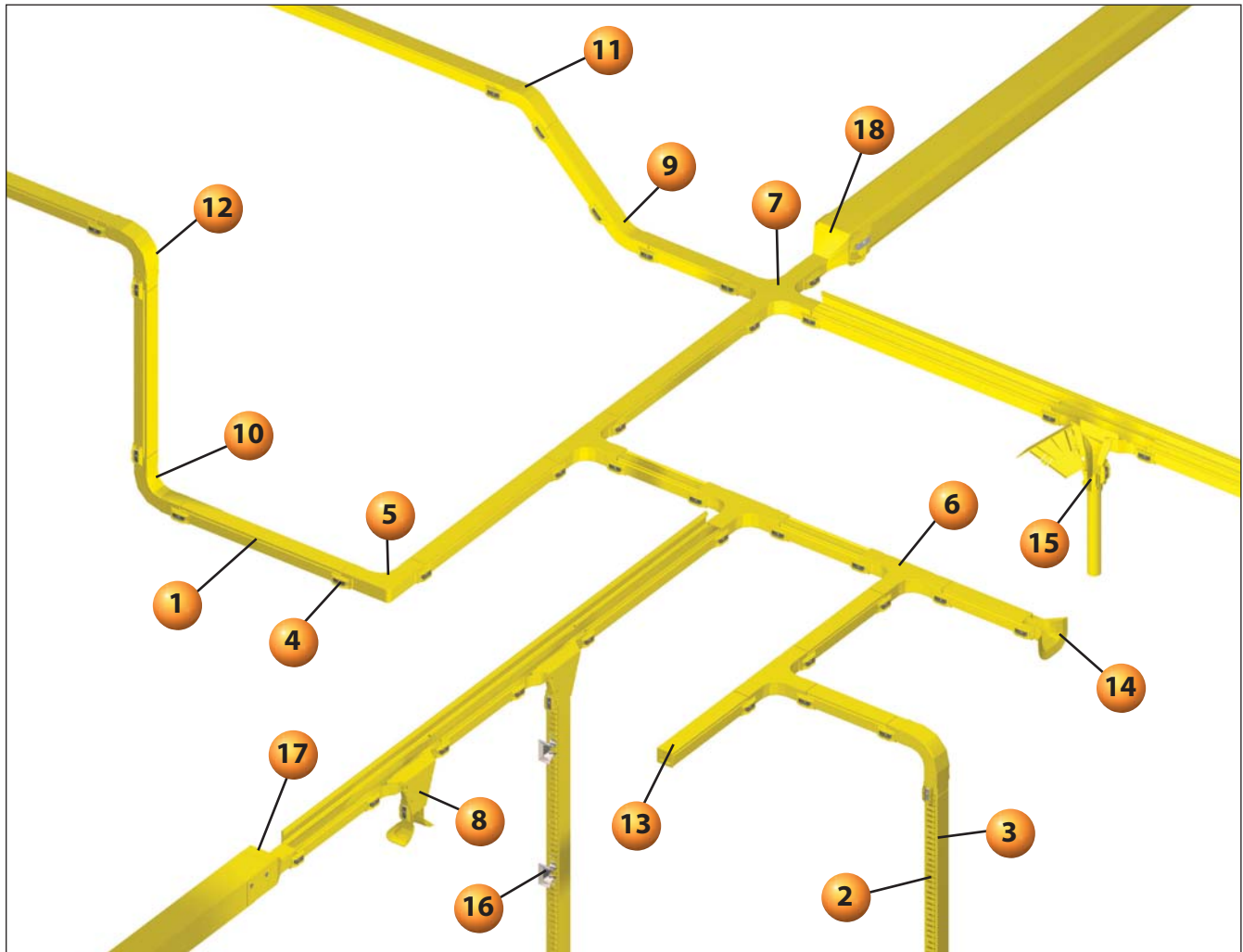

Fiber-Duct™ Mounting Brackets

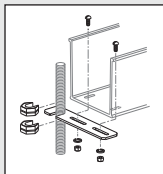

FTRBE12 – Existing Threaded Rod Bracket
(page J.63)

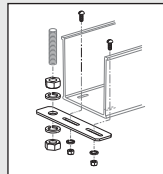

FTRBN12 – New Threaded Rod Bracket
(page J.63)

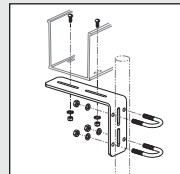

FUSB – Underfloor Pedestal Bracket
(page J.63)

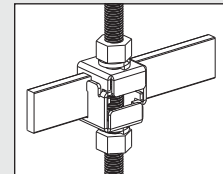

F2PCLB12 – Two-Piece Ladder Rack Bracket for Attaching Threaded Rod to 1 1/2" – 2" Ladder Rack
(page J.64)

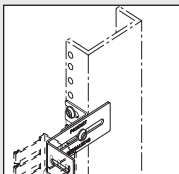

FZBA1.5X4 – Adjustable "Z" Bracket
(page J.64)

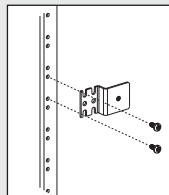

FZBLP – Low Profile "Z" Bracket
(page J.64)

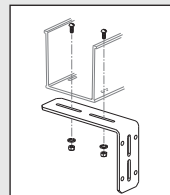

FLB – "L" Wall Mount Bracket
(page J.63)

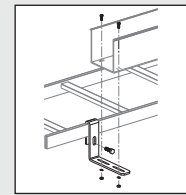

FLRB – Ladder Rack Bracket
(page J.63)

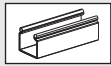

1

HS2X26 – 2x2 FiberRunner® Hinged Channel (page J.52)**

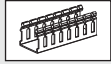

2

H2X26 – 2x2 FiberRunner® Hinged Slotted Channel (page J.52)**



3

HC26 – 2x2 FiberRunner® Snap-On Hinged Cover (page J.52)**



4

FBC2X2 – 2x2 QuikLock™ Coupler (page J.53)**



5

FRA2X2 – 2x2 Horizontal Right Angle Fitting (page J.60)**



6

FT2X2 – 2x2 Horizontal Tee Fitting (page J.60)**

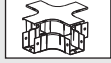

7

FFWC2X2 – 2x2 4-Way Cross Fitting (page J.60)**



8

FVTHD2X2 – 2x2 Vertical Tee (page J.54)**



9

FIV452X2 – 2x2 Inside Vertical 45° Angle Fitting (page J.60)**

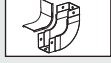

10

FIVRA2X2 – 2x2 Inside Vertical Right Angle Fitting (page J.60)**



11

FOV452X2 – 2x2 Outside 45° Angle Fitting (page J.60)**



12

FOVRA2X2 – 2x2 Outside Vertical Right Angle Fitting (page J.60)**



13

FHDEC2X2 – 2x2 End Cap Fitting (page J.53)**



14

FTR2X2 – 3-Sided BRC Trumpet Spillout for 2x2 Exit (page J.61)**



15

FIDT2X2 – 1-Port Spillout to 1.5" (38mm) Inside Diameter Corrugated Tubing (page J.61)**



16

TRC2HDBL – 2x2 Hinged Channel 1" Bend Radius Control Trumpet (page J.54)



17

FRF42 – 4x4 to 2x2 Fiber-Duct™ Reducer Fitting (page J.60)**



18

FRRF4FD2 – 4x4 FiberRunner® to 2x2 Reducer Fitting (page J.43)**

**Available colors include: YL (Yellow), OR (Orange), BL (Black), and LG (Light Gray).



2x2 FiberRunner® Routing System

Cable Fills for 2x2 FiberRunner® Cable Routing System

The maximum amounts may vary according to the cable fill installation methods, straightness of cables, etc.

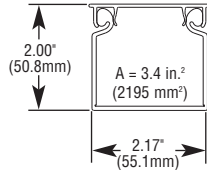

2x2 FiberRunner® Cable Routing System								
Fill/Pile Up	Internal Area (in²)	Diameter 1.6mm 0.063"	Diameter 2.0mm 0.079"	Diameter 3.0mm 0.118"	Fiber Optic Ribbon Interconnect Cable Diameter 5.20mm 0.205"	Category 6A (SD) Diameter 6.1mm 0.240"	Category 6A Diameter 7.6mm 0.300"	Category 6 Diameter 6.1mm 0.240"
40% Fill								
2" Pile Up	3.40	436	279	124	41	30	19	30
50% Fill								
2" Pile Up	3.40	546	349	155	52	38	24	38
60% Fill								
2" Pile Up	3.40	655	419	186	62	45	29	45

Channel cutting instructions: For optimum results, use a miter box and saw. For larger quantities use a plastic cutting saw blade for clean, burr-free cuts. Recommend: Carbide 80T and 100T; .090" thickness, .125" kerf.

The above cable diameters represent the nominal Panduit cable diameter per performance level. For specific cable fill information based on specific part numbers, please contact Panduit customer service.

2x2 FiberRunner® Routing System – Channels and Cover

- 2x2 system ideal for use with smaller cable counts
- Multiple spillout options provide versatility to mate to various equipment and rack configurations
- QuikLock™ Couplers reduce system installation time dramatically
- Channel, covers, fittings and other non-metallic system components made from V-0 flame class rated material
- Compatible with all sizes of Panduit® FiberRunner® and Panduit® Fiber-Duct™ Routing Systems, cable management, and racks
- 2x2 FiberRunner® Hinged and Slotted Channels can be used with 2x2 Fiber-Duct™ fittings (see page J.52) and brackets (see pages J.55 and J.56)
- Compliant with the applicable tests in Telcordia GR-63-CORE Network Equipment Building Systems (NEBS) Level 3



HS2X2



H2X2



HC2



WR2H-C

Part Number	Part Description	Std. Pkg. Qty.	Std. Ctn. Qty.
2x2 FiberRunner® Hinged Channel			
HS2X2YL6NM	Used to carry the cables throughout the system. Accepts hinged cover HC2YL6. Use QuikLock™ Coupler FBC2X2YL to attach channel and/or fittings.	6	120
2x2 FiberRunner® Hinged Slotted Channel			
H2X2YL6	Used to carry the cables vertically to the front or the back of equipment racks throughout the system. Accepts hinged cover HC2YL6. Extra supports required when used in horizontal applications. Use QuikLock™ Coupler FBC2X2YL to attach channel and/or fittings.	6	120
2x2 Snap-On Hinged Cover			
HC2YL6	Optional snap-on cover for hinged channel HS2X2YL6 or H2X2YL6. The innovative cover can hinge open to 90° from either side of the channel and be removed completely if desired.	6	120
Cable Retainer for 2x2 System			
WR2H-C	Cable retainer can be installed between the slotted channel (H2X2YL6) fingers to retain cables. It can be used with cover and installs anywhere on channel. One retainer should be used approximately every 18" (457mm). Black color only.	100	1000

NOTE: Available with mounting holes. To order, delete NM from the part number. For other colors replace YL (Yellow) with OR (Orange), BL (Black), or LG (Light Gray). Order number of feet required, in multiples of standard 6' length increments.

2x2 FiberRunner® QuikLock™ Coupler

- Pre-assembled to provide fast mechanical assembly of components
- No tools required for installation; bolts loosen for component disassembly



Part Number	Part Description	Std. Pkg. Qty.	Std. Ctn. Qty.
FBC2X2YL	Pre-assembled coupler quickly joins two sections of hinged channel and/or fittings. Mechanically attaches without tightening bolts. Bolts release using 5/16" nut driver to allow coupler to be removed if necessary.	1	5

For other colors replace suffix YL (Yellow) with OR (Orange), BL (Black), or LG (Light Gray).

2x2 FiberRunner® System Fitting



Part Number	Part Description	Std. Pkg. Qty.	Std. Ctn. Qty.
FHDEC2X2YL	Used for closing off open ends of the hinged channel or fittings. No coupler required. Push-on installation.	1	5

For other colors replace suffix YL (Yellow) with OR (Orange), BL (Black), or LG (Light Gray).

2x2 FiberRunner[®] System Spillouts

- Spill-overs allow safe transition from horizontal to vertical runs
- 2" bend radius control
- Transition to channel, slotted channel, and corrugated loom tubing

**FVTHD2X2****FTR2X2****FIDT2X2****FRHD2KT****TRC2HDBL**

Part Number	Part Description	Couplers Required	Std. Pkg. Qty.	Std. Ctn. Qty.
-------------	------------------	-------------------	----------------	----------------

2x2 Vertical Tee

FVTHD2X2YL	Attaches to 2x2 channel to create a 90° vertical drop from a horizontal run. Hinged door included. Accepts channel cover in conjunction with channel. Use QuikLock™ Coupler FBC2X2YL with HS2X2YL6 or H2X2YL6 channels. Use snap rivets NR2WH-L or bolts F14PN-L with S2X2YL6 or E2X2YL6 channels. Also accepts FIDT2X2YL.	(2 pcs.) FBC2X2YL	1	5
-------------------	--	----------------------	---	---

3-Sided BRC Trumpet Spillout for 2x2 Exit

FTR2X2YL	Used to limit the bend radius of the cable to 2" (50.8mm) when exiting from a FiberRunner [®] Spill-Over FRSPYL or from 2x2 Fiber-Duct™ Channel.	(1 pc.) FBC2X2YL	1	5
-----------------	---	---------------------	---	---

1-Port Spillout to 1.5" (38mm) Inside Diameter Corrugated Tubing

FIDT2X2YL	Used to route cable into one piece of 1.5" (38mm) diameter split corrugated tubing. Used with FiberRunner [®] Spill-Over FRSPYL, 2x2 Fiber-Duct™ Fittings, and the 2x2 FiberRunner [®] Hinged Channel. Securely holds split corrugated tubing to ensure system integrity and easy access to add or remove cables.	(1 pc.) FBC2X2YL	1	5
------------------	---	---------------------	---	---

2x2 Hinged Duct Vertical Cable Manager Kit

FRHD2KTYL	Provides secure, accessible route for cables spilling out from a vertical tee or spill-over junction to rack mounted equipment. Kit includes 6' length of 2x2 FiberRunner [®] Hinged Channel H2X2YL6, 6' length of 2x2 snap-on hinged cover HC2YL6, four adjustable "Z" brackets FZBA1.5X4, one FiberRunner [®] 2x2 End Cap FHDEC2X2YL, six hinged duct 2" wire retainers WR2H-C and all required mounting hardware. Attaches to 2x2 vertical tee exit or spill-over junction with a 2x2 exit with a 2x2 QuikLock™ Coupler FBC2X2YL. Also attaches directly to 4x4 or 6x4 vertical tee exits with low profile reducer FRLPR42BL. Yellow and orange colors only.	—	1	—
------------------	---	---	---	---

2x2 FiberRunner[®] Bend Radius Control Trumpet

TRC2HDBL	Bend radius control trumpet for exiting at the sidewall of 2" wall heights of type H hinged cover wiring duct channels. Maintains 1" (25.4mm) bend radius control. Black color only.	—	1	10
-----------------	--	---	---	----

For other colors replace suffix YL (Yellow) with OR (Orange), BL (Black), or LG (Light Gray).

FIBER-DUCT™ ROUTING SYSTEMS

Panduit provides leading solutions for cable routing. These routing products are compatible with our cable management solutions increasing your ability to maintain an orderly and clean work environment, implement quick and easy moves, adds, and changes, and maintain the integrity of your fiber and copper cabling plant in order to maximize long-term performance.



- Two system sizes available: 4x4 and 2x2
- Minimum 2" (50.8mm) bend radius fittings protect against signal loss due to excessive cable bends
- Optimized for use with Pan-Net® Network Solutions
- Snap-on non-slip covers
- Compatible with Panduit® FiberRunner® 12x4, 6x4, 4x4, and 2x2 Routing Systems

The 2x2 and 4x4 Fiber-Duct™ Routing Systems are comprised of channel, fittings, and brackets designed to segregate, route, and protect fiber optic and copper cabling to and between racks within the telecommunications room.

As part of the Panduit Data Center Solution, Fiber-Duct™ Routing Systems offers secure, reliable system integration and risk management within the physical infrastructure.

2x2 and 4x4 Fiber-Duct™ Routing Systems Roadmap

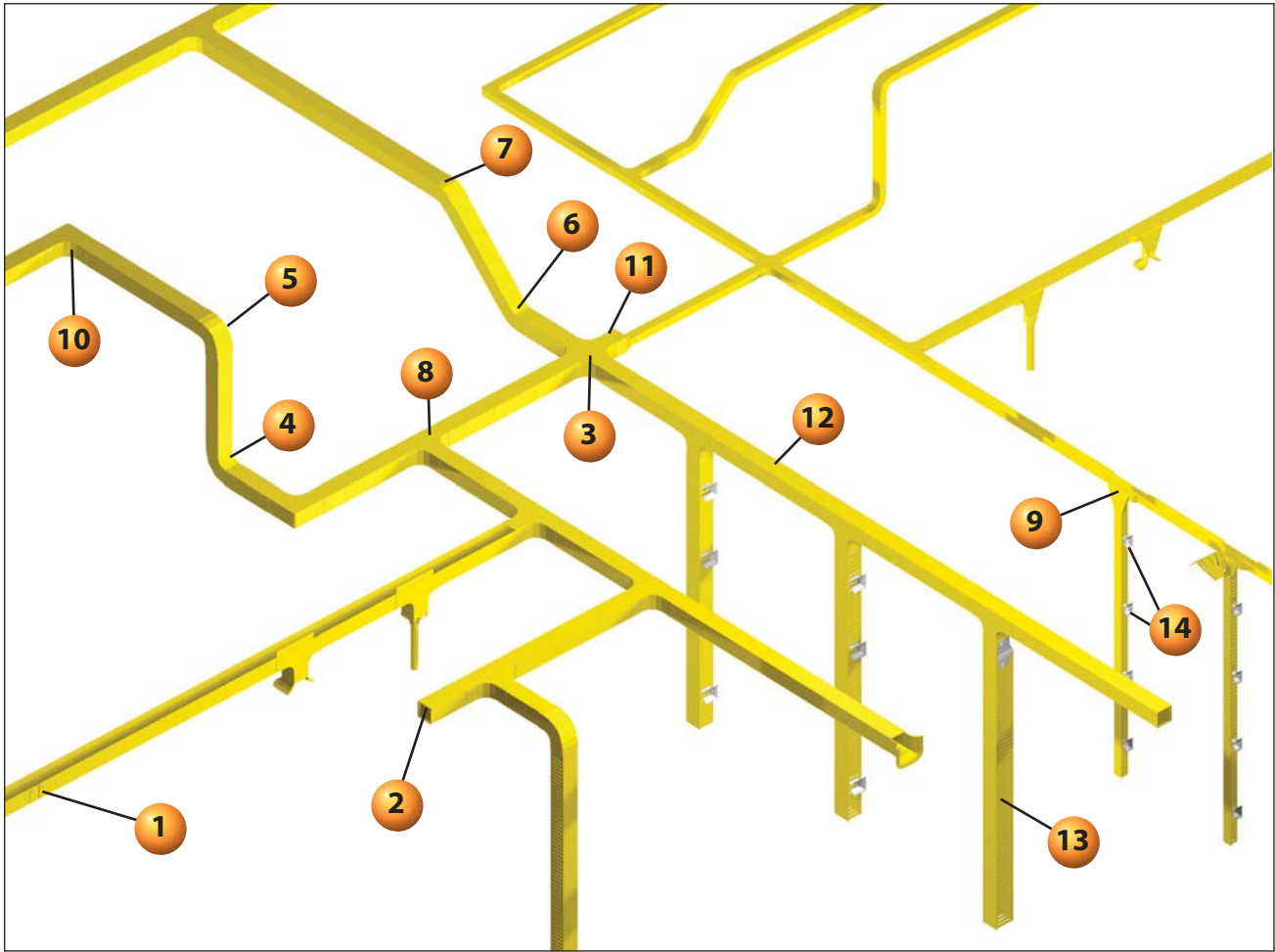

Fiber-Duct™ Mounting Brackets

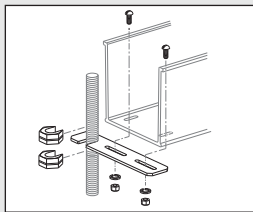

FTRBE12 – Existing Threaded Rod Bracket (page J.63)

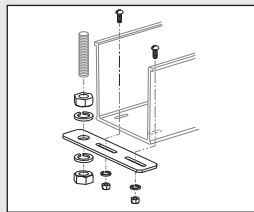

FTRBN12 – New Threaded Rod Bracket (page J.63)

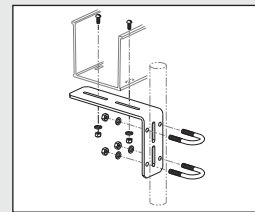

FUSB – Underfloor Pedestal Bracket (page J.63)

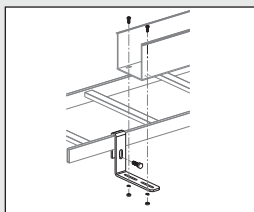

FLRB – Ladder Rack Bracket (page J.63)

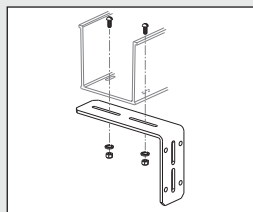

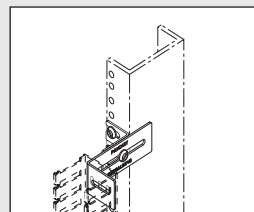

FLB – "L" Wall Mount Bracket (page J.63)

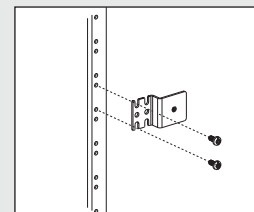

FZBA1.5X4 – Adjustable "Z" Bracket (page J.64)

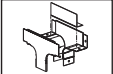

FZBLP – Low Profile "Z" Bracket (page J.64)

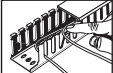
- 
1 FCF2X2** and FCF4X4 – Coupler Fitting (page J.60)
- 
2 FEC2X2** and FEC4X4** – End Cap Fitting (page J.60)
- 
3 FFWC2X2** and FFWC4X4** – 4-Way Cross Fitting (page J.60)
- 
4 FIVRA2X2** and FIVRA4x4** – Inside Vertical Right Angle (page J.60)
- 
5 FOVRA2X2** and FOVRA4X4** – Outside Vertical Right Angle (page J.60)
- 
6 FIV452X2** and FIV454X4** – Inside Vertical 45° Angle (page J.60)
- 
7 FOV452X2** and FOV454X4** – Outside Vertical 45° Angle (page J.60)
- 
8 FT2X2** and FT4X4** – Horizontal Tee Fitting (page J.60)
- 
9 FVT4X4** – 4x4 Vertical Tee (page J.61)
- 
10 FRA2X2** – FRA4X4** – Right Angle Fitting (page J.60)
- 
11 FRF42** – 4x4 to 2x2 Fiber-Duct™ Reducer Fitting (page J.60)
- 
12 S2X2**6NM and S4X4**6NM Fiber-Duct™ Channel (page J.59)
- 
13 E2X2**6 and E4X4**6 Fiber-Duct™ Slotted Channel (page J.59)
- 
14 TRC2BL and TRC4BL – Bend Radius Control Trumpet (page J.62)

**Available colors include: YL (Yellow), OR (Orange), BL (Black), and LG (Light Gray).



2x2 and 4x4 Fiber-Duct™ Routing Systems

Cable Fills for 2x2 and 4x4 Fiber-Duct™ Cable Routing Systems

The maximum amounts may vary according to the cable fill installation methods, straightness of cables, etc.

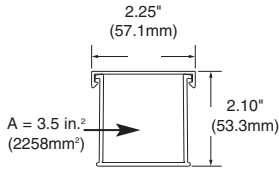

2x2 Fiber-Duct™ Cable Routing System								
Fill/Pile Up	Internal Area (In.²)	Diameter 1.6mm 0.063"	Diameter 2.0mm 0.079"	Diameter 3.0mm 0.118"	Fiber Optic Flat Ribbon Interconnect Cable 5.20mm 0.205"	Category 6A (SD) Diameter 6.1mm 0.240"	Category 6A Diameter 7.6mm 0.300"	Category 6 Diameter 6.1mm 0.240"
40% Fill								
2" Pile Up	3.5	449	288	128	42	31	20	31
50% Fill								
2" Pile Up	3.5	562	359	160	53	39	25	39
60% Fill								
2" Pile Up	3.5	674	431	192	64	46	30	46

Channel cutting instructions: For optimum results, use a miter box and saw. For larger quantities use a plastic cutting saw blade for clean, burr-free cuts. Recommend: Carbide 80T and 100T; .090" thickness, .125" kerf.

The above cable diameters represent the nominal Panduit cable diameter per performance level. For specific cable fill information based on specific part numbers, please contact Panduit customer service.

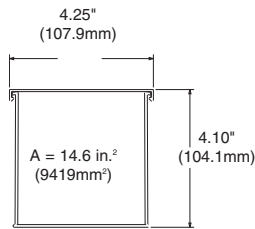

4x4 Fiber-Duct™ Cable Routing System								
Fill/Pile Up	Internal Area (In.²)	Diameter 1.6mm 0.063"	Diameter 2.0mm 0.079"	Diameter 3.0mm 0.118"	Fiber Optic Flat Ribbon Interconnect Cable 5.20mm 0.205"	Category 6A (SD) Diameter 6.1mm 0.240"	Category 6A Diameter 7.6mm 0.300"	Category 6 Diameter 6.1mm 0.240"
40% Fill								
2" Pile Up	7.6	976	624	277	92	67	43	67
3" Pile Up	11.3	1450	928	413	137	100	64	100
4" Pile Up	14.6	1874	1199	533	177	129	83	129
50% Fill								
2" Pile Up	7.6	1219	780	347	115	84	54	84
3" Pile Up	11.3	1813	1160	516	171	125	80	125
4" Pile Up	14.6	2343	1499	666	221	161	103	161
60% Fill								
2" Pile Up	7.6	1463	936	416	138	101	65	101
3" Pile Up	11.3	2176	1392	619	205	150	96	150
4" Pile Up	14.6	2811	1799	800	265	194	124	194

Channel cutting instructions: For optimum results, use a miter box and saw. For larger quantities use a plastic cutting saw blade for clean, burr-free cuts. Recommend: Carbide 80T and 100T; .090" thickness, .125" kerf.

The above cable diameters represent the nominal Panduit cable diameter per performance level. For specific cable fill information based on specific part numbers, please contact Panduit customer service.



2x2 and 4x4 Fiber-Duct™ Routing Systems

- Channel, covers, fittings and other non-metallic system components made from V-0 flame class rated material
- Snap-on non-slip covers
- Fittings have 2" bend radius control
- Compatible with Panduit® FiberRunner® 2x2, 4x4, 6x4 and 12x4 Routing Systems

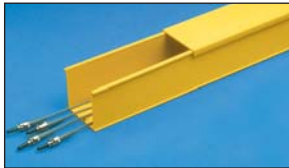

S2X2
S4X4



E2X2
E4X4



C2
C4

Part Number	Part Description	System Size	Std. Pkg. Qty.	Std. Ctn. Qty.
Fiber-Duct™ Channel				
S2X2YL6NM	Used to carry the cables throughout the Fiber-Duct™ Routing System. Accepts cover C2YL6. Cover sold separately.	2x2	6	120
S4X4YL6NM	Used to carry the cables throughout the Fiber-Duct™ Routing System. Accepts cover C4YL6. Cover sold separately.	4x4	6	60

Fiber-Duct™ Slotted Channel				
E2X2YL6	Used to carry the cables vertically to the front or the back of equipment racks throughout the system. Accepts cover C2YL6. Extra supports required when used in horizontal applications. Cover sold separately.	2x2	6	120
E4X4YL6	Used to carry the cables vertically to the front or the back of equipment racks throughout the system. Accepts cover C4YL6. Extra supports required when used in horizontal applications. Cover sold separately.	4x4	6	60

Fiber-Duct™ Cover				
C2YL6	Cover for Fiber-Duct™ Channel and Fiber-Duct™ Slotted Channel. Non-slip cover design incorporates integral high friction lining to inhibit cover movement.	2x2	6	120
C4YL6	Cover for Fiber-Duct™ Channel and Fiber-Duct™ Slotted Channel. Non-slip cover design incorporates integral high friction lining to inhibit cover movement.	4x4	6	120

NOTE: Available with mounting holes. To order, delete NM from the part number.
 For fastest installation use NR2WH-L or NR4BL-L snap rivets.
 For other colors replace YL (Yellow) with OR (Orange), BL (Black), or LG (Light Gray).
 Order number of feet required, in multiples of standard 6' length increments.

Fiber-Duct™ System Fittings



FCF2X2
FCF4X4



FRA2X2
FRA4X4



FT2X2
FT4X4



FFWC2X2
FFWC4X4



FEC2X2
FEC4X4



FIV452X2
FIV454X4



FOV452X2
FOV454X4



FIVRA2X2
FIVRA4X4



FOVRA2X2
FOVRA4X4



FRF42

Part Number	Part Description	System Size	Std. Pkg. Qty.	Std. Ctn. Qty.
-------------	------------------	-------------	----------------	----------------

Coupler Fitting

FCF2X2YL	Used to join two sections of duct together. Fiber-Duct™ Coupler is not required at each fitting connection.	2x2	1	5
FCF4X4YL		4x4	1	5

Horizontal Right Angle Fitting

FRA2X2YL	Attaches to channel to create a 90° horizontal turn from a straight horizontal run. Cover included.	2x2	1	5
FRA4X4YL		4x4	1	5

Horizontal Tee Fitting

FT2X2YL	Attaches to channel to create a 90° horizontal branch from a straight horizontal run. Cover included.	2x2	1	5
FT4X4YL		4x4	1	5

Four Way Cross Fitting

FFWC2X2YL	Attaches to channel to create a horizontal four way cross intersection. Cover included.	2x2	1	5
FFWC4X4YL		4x4	1	5

End Cap Fitting

FEC2X2YL	Used for closing off open ends of the channel. No coupler required. Push-on installation.	2x2	1	5
FEC4X4YL		4x4	1	5

Inside Vertical 45° Angle Fitting

FIV452X2YL	Attaches to channel to create a 45° upward angle from a straight horizontal run. Used with outside vertical 45° angle fitting FOV452X2YL or FOV454X4YL to change level of straight horizontal runs. Cover included.	2x2	1	5
FIV454X4YL		4x4	1	5

Outside Vertical 45° Angle Fitting

FOV452X2YL	Attaches to channel to create a 45° downward angle from a straight horizontal run. Used with inside vertical 45° angle fitting FIV452X2YL or FIV454X4YL to change level of straight horizontal runs. Cover included.	2x2	1	5
FOV454X4YL		4x4	1	5

Inside Vertical Right Angle Fitting

FIVRA2X2YL	Attaches to channel to create a 90° upward angle from a straight horizontal run. Used with outside vertical 90° angle fitting FOVRA2X2YL or FOVRA4X4YL to change level of straight horizontal runs. Cover included.	2x2	1	5
FIVRA4X4YL		4x4	1	5

Outside Vertical Right Angle Fitting

FOVRA2X2YL	Attaches to channel to create a 90° downward angle from a straight horizontal run. Used with inside vertical 90° angle fitting FIVRA2X2YL or FIVRA4X4YL to change level of straight horizontal runs. Cover included.	2x2	1	5
FOVRA4X4YL		4x4	1	5

4x4 to 2x2 Fiber-Duct™ Reducer Fitting

FRF42YL	Joins any 4x4 Fiber-Duct™ Fitting to the 2x2 Fiber-Duct™ Channel, S2X2YL6 or E2X2YL6. Includes cover.	2x2 4x4	1	5
----------------	---	------------	---	---

For other colors replace suffix YL (Yellow) with OR (Orange), BL (Black), or LG (Light Gray).
Fittings include 5/16" assembly holes for fast mechanical fastening.

Fiber-Duct™ Spillouts



FVTHD2X2



FTR2X2



FIDT2X2



FVT4X4



FTR4X4



FIDT4X4BL

Part Number	Part Description	System Size	Std. Pkg. Qty.	Std. Ctn. Qty.
2x2 Vertical Tee				
FVTHD2X2YL	Attaches to 2x2 channel to create a 90° vertical drop from a horizontal run. Hinged door included. Accepts channel cover in conjunction with channel. Use QuikLock™ Coupler FBC2X2YL with HS2X2YL6 or H2X2YL6 channels. Use snap rivets NR2WH-L or bolts F14PN-L with S2X2YL6 or E2X2YL6 channels. Also accepts FIDT2X2YL.	2x2	1	5
3-Sided BRC Trumpet Spillout for 2x2 Exit				
FTR2X2YL	Used to limit the bend radius of the cable to 2" (50.8mm) when exiting from a FiberRunner® Spill-Over FRSPYL or from 2x2 Fiber-Duct™ Channel.	2x2	1	5
1-Port Spillout to 1.5" (38mm) Inside Diameter Corrugated Tubing				
FIDT2X2YL	Used to route cable into one piece of 1.5" (38mm) diameter split corrugated tubing. Used with FiberRunner® Spill-Over FRSPYL, 2x2 Fiber-Duct™ Fittings, and the 2x2 FiberRunner® Hinged Channel. Securely holds split corrugated tubing to ensure system integrity and easy access to add or remove cables.	2x2	1	5
4x4 Vertical Tee				
FVT4X4YL	Attaches to channel to create a 90° vertical drop from a horizontal run. Accepts FIDT4X4BL, FTR4X4YL, S4X4YL6 or E4X4YL6 directly.	4x4	1	5
3-Sided Vertical Tee Trumpet Spillout				
FTR4X4YL	Used to limit the bend radius of the cable to 2" (50.8mm) when exiting from a 4x4 or 6x4 FiberRunner® Vertical Tee and 4x4 Fiber-Duct™ Fittings.	4x4	1	5
2-Port Spillout to 1.5" (38mm) Inside Diameter Corrugated Tubing				
FIDT4X4BL	Used to route cable into one or two pieces of 1.5" (38mm) diameter split corrugated tubing. Used with FRVT6X4YL, FRVT4X4YL, or FVT4X4YL. Securely holds corrugated split tubing to ensure system integrity and easy access to add or remove cables. Black color only.	4x4	1	5

For other colors replace suffix YL (Yellow) with OR (Orange), BL (Black), or LG (Light Gray).

Fiber-Duct™ Bend Radius Control Trumpets

- Provide method to transition cabling into rack system
- Maintain 1" (25.4mm) bend radius control



TRC2BL



TRC4BL

Fiber-Duct™ AccessoriesNR2
NR4

F14PWN-L



F14PN-L

Part Number	Part Description	System Size	Std. Pkg. Qty.	Std. Ctn. Qty.
TRC2BL	Bend radius control trumpet for exiting at the sidewall of 2" wall heights of type G, FS or E Fiber-Duct™ Channels.	2x2	1	10
TRC4BL	Bend radius control trumpet for exiting at the sidewall of 4" wall heights of type G, FS or E Fiber-Duct™ Channels.	4x4	1	10

Part Number	Part Description	System Size	Std. Pkg. Qty.	Std. Ctn. Qty.
Snap Rivets				
NR2WH-L	Snap rivet fastens channel and fittings together for added strength and rigidity. Snap rivet mounts flush to surfaces.	2x2	50	500
NR4BL-L		4x4	50	500
Plastic Bolts and Nuts				
F14PWN-L	1/4" plastic bolts and wing nuts fastens channel and fittings together for added strength and rigidity.	2x2 4x4	50	500
F14PN-L		2x2 4x4	50	500

Fiber-Duct™ Mounting Brackets



FTRBE12/FTRBE12M
FTRBE58



FTRBN12/FTRBN12M
FTRBN58



FUSB

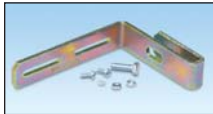

FLRB

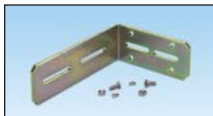

FLB

Part Number	Part Description	For Threaded Rod Size	Std. Pkg. Qty.	Std. Ctn. Qty.
Existing Threaded Rod Bracket for Fiber-Duct™ System				
FTRBE12	Used for supporting the 2x2 and 4x4 Fiber-Duct™ Systems from existing threaded rod installations. Bracket is secured to threaded rod with two split nuts. Contains hardware for attaching to threaded rods and hardware for mounting channel to bracket.	1/2"	1	10
FTRBE12M		12mm	1	10
FTRBE58		5/8"	1	10
New Threaded Rod Bracket for Fiber-Duct™ System				
FTRBN12	Used for supporting the 2x2 and 4x4 Fiber-Duct™ Systems from new threaded rod installations. Bracket is secured to threaded rod with two nuts. Contains hardware for attaching to threaded rods and hardware for mounting channel to bracket.	1/2"	1	10
FTRBN12M		12mm	1	10
FTRBN58		5/8"	1	10
Underfloor Pedestal Bracket for Fiber-Duct™ System				
FUSB	Used to support the 2x2 and 4x4 Fiber-Duct™ Systems by attaching to underfloor pedestal (not included). Use on pedestals up to 1" in diameter. Bracket contains hardware to attach to pedestal and hardware for mounting channel to bracket.	—	1	10
Ladder Rack Bracket for Fiber-Duct™ System				
FLRB	Used to support the 2x2 and 4x4 Fiber-Duct™ Systems attaching directly to any 3/8" (9.5mm) x 1 1/2" (38.1mm) or 3/8" (9.5mm) x 2" (50.8mm) ladder rack rail. No threaded rod required. Contains hardware for mounting channel to bracket.	—	1	10
"L" Wall Mount Bracket for Fiber-Duct™ System				
FLB	Used to support 2x2 and 4x4 Fiber-Duct™ Systems by attaching to a wall or the front or back of an equipment rack. Contains hardware for mounting channel to bracket.	—	1	10

Table continued on page J.64

Fiber-Duct™ Mounting Brackets (continued)**FZBA1.5X4****FZBLP****F2PCLB12
F2PCLB58****FRAFC58**

Part Number	Part Description	For Threaded Rod Size	Std. Pkg. Qty.	Std. Ctn. Qty.
Adjustable "Z" Bracket				
FZBA1.5X4	Bracket used to offset Fiber-Duct™ System from mounting surface, adjustable from 1.5" (38mm) to 4" (101mm). Typically used on the front of an equipment rack.	—	1	10
Low Profile "Z" Bracket				
FZBLP	Bracket used to offset 2x2 or 4x4 Fiber-Duct™ System and hinged duct from the front face of an equipment rack. Bracket provides a secure mounting surface .67" (17mm) from the front of an equipment rack.	—	1	10
Two-Piece Ladder Rack Bracket for Attaching Threaded Rod to 1 1/2" – 2" Ladder Rack				
F2PCLB12	Two-piece bracket attaches to 3/8" (9.5mm) wide x 1 1/2" (38.1mm) or 3/8" (9.5mm) wide x 2" (50.8mm) ladder rack rail. Bracket halves slide into position and clamp together on the ladder rack rail, which allows for a one-handed assembly of the threaded rod (not included). Contains bracket and hardware for attaching bracket to ladder rack.	1/2"	1	10
F2PCLB58		5/8"	1	10
Two-Piece Framing Clip for Attaching 5/8" Threaded Rod to 2" x 9/16" C-Channel Auxiliary Framing Bars				
FRAFC58	Two-piece framing clip attaches to auxiliary framing bars. Framing clip halves slide into position and interlock on the auxiliary framing bars, allowing easier assembly of the threaded rod to bars. Contains two-piece framing clip and hardware for attaching framing clip to auxiliary framing bars (5/8" threaded rod not included).	5/8"	1	10

WYR-GRID® OVERHEAD CABLE TRAY ROUTING SYSTEM

Panduit provides an overhead cable tray system that minimizes installation time and simplifies cable management for contractors and network technicians. The Wyr-Grid® Overhead Cable Tray Routing System is designed to route and manage copper data cables, premise distribution fiber optic cables, and power cables within data centers, connected buildings, and industrial automation applications. Innovative features provide quick, easy assembly that reduce installation time to half that of typical wire basket or ladder rack systems, thus minimizing installation costs.

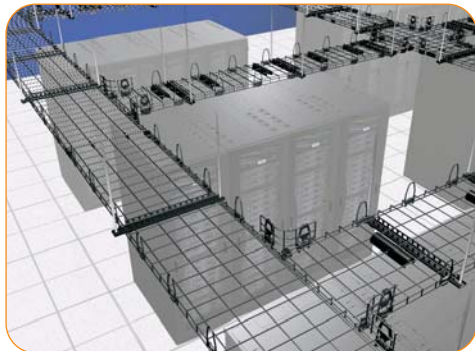
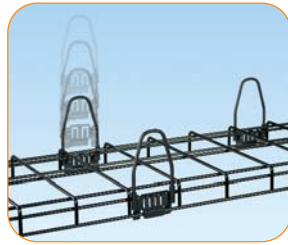
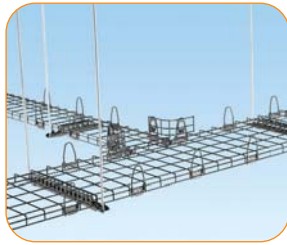

- Wyr-Grid® Pathways are provided in four widths: 12" (305mm), 18" (457mm), 24" (610mm), and 30" (762mm)
- Wyr-Grid® System incorporates non-integral snap-on sidewalls which minimize specification requirements and are offered in three different heights: 2" (50mm), 4" (102mm), and 6" (152mm)
- Wyr-Grid® Splice Connectors have an integral bonding screw that creates a mechanical-electrical bond between cable tray pathway sections
- Wyr-Grid® Waterfalls are offered in two different configurations that attach to all pathway sections 12" (305mm), 18" (457mm), 24" (610mm), and 30" (762mm) to facilitate bend radius control and cable management
- Wyr-Grid® Support Brackets are offered in various widths to accommodate pathways: 12" (305mm), 18" (457mm), 24" (610mm), and 30" (762mm); have an integral quick-clip retention; accommodate 1/2" or 12 mm threaded rod

The Wyr-Grid® Overhead Cable Tray Routing System can easily accommodate FiberRunner® Pathways into the application to provide a segregated copper and fiber cabling solution.

As part of the Panduit Data Center Solution, the Wyr-Grid® System offers secure, reliable system integration and risk management within the physical infrastructure.

Wyr-Grid[®] Overhead Cable Tray Routing System Roadmap

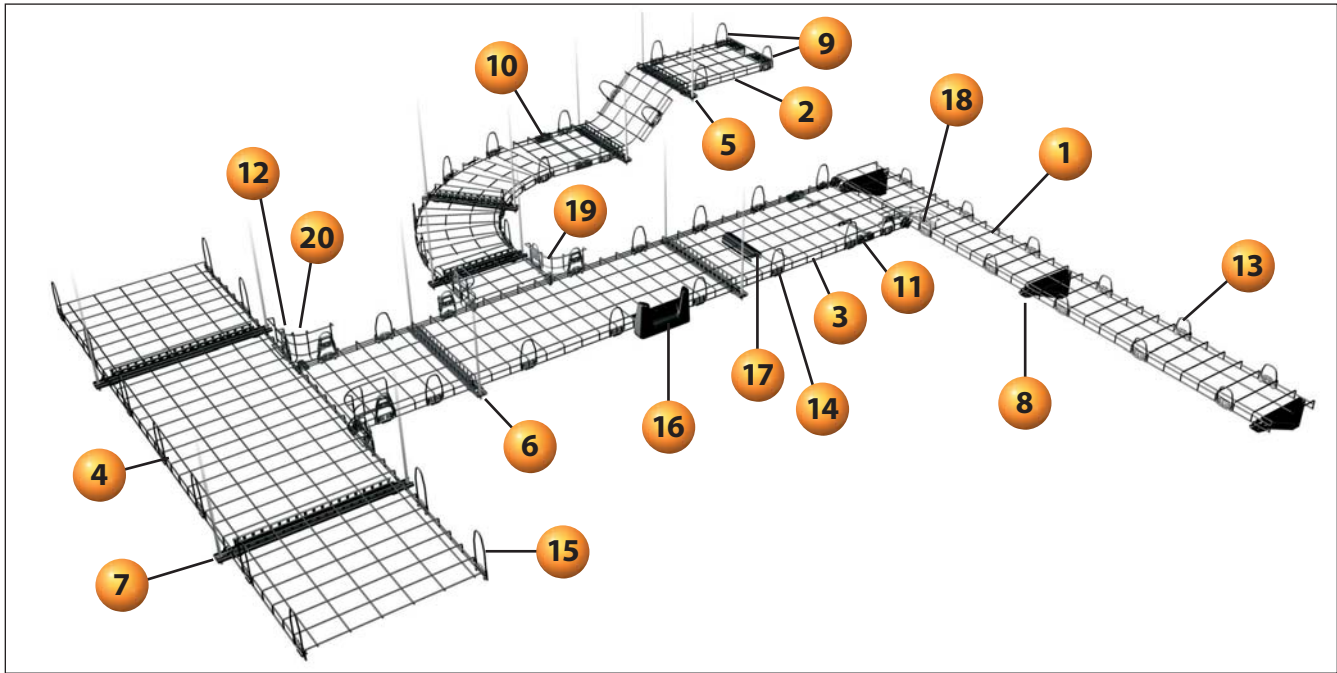

Wyr-Grid[®] Mounting Brackets

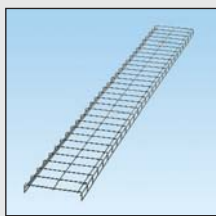

- 1** WG12BL10 – Wyr-Grid[®] 12" Wide x 10' Long Pathway Section (page J.67)
- 2** WG18BL10 – Wyr-Grid[®] 18" Wide x 10' Long Pathway Section (page J.67)
- 3** WG24BL10 – Wyr-Grid[®] 24" Wide x 10' Long Pathway Section (page J.67)
- 4** WG30BL10 – Wyr-Grid[®] 30" Wide x 10' Long Pathway Section (page J.67)



- 10** WGSPL1218BL – Wyr-Grid[®] Splice Connectors for 12" and 18" Widths (page J.68)
- 11** WGSPL2430BL – Wyr-Grid[®] Splice Connectors for 24" and 30" Widths (page J.68)



- 12** WGINTSPLBL – Wyr-Grid[®] Intersection Splices (page J.68)



- 5** WGTB18BL – Wyr-Grid[®] 18" Trapeze Bracket (page J.69)
- 6** WGTB24BL – Wyr-Grid[®] 24" Trapeze Bracket (page J.69)
- 7** WGTB30BL – Wyr-Grid[®] 30" Trapeze Bracket (page J.69)



- 13** WGSDWL2BL – Wyr-Grid[®] 2" Snap-On Sidewall (page J.71)
- 14** WGSDWL4BL – Wyr-Grid[®] 4" Snap-On Sidewall (page J.71)
- 15** WGSDWL6BL – Wyr-Grid[®] 6" Snap-On Sidewall (page J.71)



- 8** WGSB12BL – Wyr-Grid[®] Cantilever Bracket (page J.69)



- 16** WGSDWWF4BL – Wyr-Grid[®] 4" Sidewall Waterfall (page J.68)



- 17** WGBTMWFBL – Wyr-Grid[®] Bottom Waterfall (page J.68)



- 9** WGWMTB1830BL – Wyr-Grid[®] 18 - 30" Wide Wall Mount Termination Bracket (page J.69)



- 18** WGINTBRC2BL – Wyr-Grid[®] 2" Snap-On Intersection Bend Radius Control High Sidewall (page J.71)
- 19** WGINTBRC4BL – Wyr-Grid[®] 4" Snap-On Intersection Bend Radius Control High Sidewall (page J.71)
- 20** WGINTBRC6BL – Wyr-Grid[®] 6" Snap-On Intersection Bend Radius Control High Sidewall (page J.71)

Wyr-Grid® Overhead Cable Tray Routing System

Wire Fill for Wyr-Grid® Overhead Cable Tray Routing System

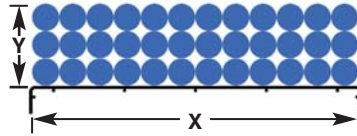

X (in.)	Y (in.)	Internal Area (in²)	Category 6A (SD) Diameter 6.1mm 0.240"	Category 6A Diameter 7.6mm 0.300"	Category 6 Diameter 6.1mm 0.240"	X (in.)	Y (in.)	Internal Area (in²)	Category 6A (SD) Diameter 6.1mm 0.240"	Category 6A Diameter 7.6mm 0.300"	Category 6 Diameter 6.1mm 0.240"
12.2	2	24.3	269	172	269	24.2	2	48.3	534	342	534
	4	48.7	538	344	538		4	96.7	1069	684	1069
	6	73.0	807	516	807		6	145.0	1603	1026	1603
18.2	2	36.3	401	257	401	30.2	2	60.3	666	427	666
	4	72.7	804	514	804		4	120.7	1334	854	1334
	6	109.0	1205	771	1205		6	181.0	2000	1280	2000

"Y" equates to the height of the Wyr-Grid® Optional Sidewalls. The internal area defines the allowable fill capacity based on the Wyr-Grid® Pathway width and optional sidewall height. The Wyr-Grid® Pathway cable fill is based on NEC allowable fill of 50%. The above cable diameters represent the nominal Panduit cable diameter per performance level.

Wyr-Grid® Pathway Sections

- Pathways are provided in four widths: 12" (305mm), 18" (457mm), 24" (610mm), and 30" (762mm)
- Standard finish is black powder coat
- Non-integral sidewalls minimize specification requirements



WG12BL10



WG18BL10

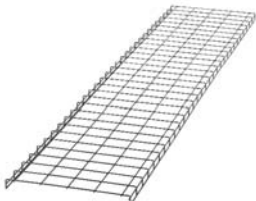

WG24BL10

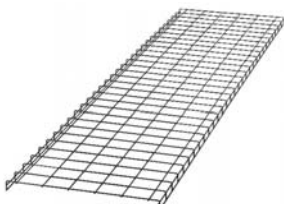

WG30BL10

Part Number	Part Description	Std. Pkg. Qty.
WG12BL10	12" wide x 10' long pathway section used to carry cables horizontally throughout the system. Snap-on sidewalls attach for job specific height requirements. Uses splice connector WGSPL1218BL to connect straight sections and intersection splice WGINTSPLBL to connect pathways at an intersection.	10
WG18BL10	18" wide x 10' long pathway section used to carry cables horizontally throughout the system. Snap-on sidewalls attach for job specific height requirements. Uses splice connector WGSPL1218BL to connect straight sections and intersection splice WGINTSPLBL to connect pathways at an intersection.	10
WG24BL10	24" wide x 10' long pathway section used to carry cables horizontally throughout the system. Snap-on sidewalls attach for job specific height requirements. Uses splice connector WGSPL2430BL to connect straight sections and intersection splice WGINTSPLBL to connect pathways at an intersection.	10
WG30BL10	30" wide x 10' long pathway section used to carry cables horizontally throughout the system. Snap-on sidewalls attach for job specific height requirements. Uses splice connector WGSPL2430BL to connect straight sections and intersection splice WGINTSPLBL to connect pathways at an intersection.	10

Order number of feet required, in multiples of standard 10' length increments.

Wyr-Grid[®] Splice Connectors

- Integral bonding screw creates a mechanical electrical bond between cable tray pathway sections
- Standard finish is black powder coat
- Sold in pairs

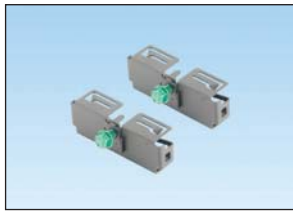
**WGSPL1218BL****WGSPL2430BL****WGINTSPLBL**

Part Number	Part Description	Std. Pkg. Qty.	Std. Ctn. Qty.
WGSPL1218BL	Straight splice connector quickly joins two 12" (305mm) or 18" (457mm) wide Wyr-Grid [®] Pathways together. A thread cutting screw pierces the paint of adjacent pathway sections providing a completely bonded connection, ensuring electrical continuity between the pathways. Package contains 2 components needed to join two pathway sections.	1	10
WGSPL2430BL	Straight splice connector quickly joins two 24" (610mm) or 30" (762mm) wide Wyr-Grid [®] Pathways together. A thread cutting screw pierces the paint of adjacent pathway sections providing a completely bonded connection, ensuring electrical continuity between the pathways. Package contains 4 components needed to join two pathway sections.	1	10
WGINTSPLBL	Intersection splice connector quickly joins Wyr-Grid [®] Pathways at all intersections. A thread cutting screw pierces the paint of perpendicular pathway sections providing a completely bonded connection, ensuring electrical continuity between the pathways. Package contains 2 components needed to create one tee or right angle intersection.	1	10

Wyr-Grid[®] Waterfalls

- Offered in two different configurations that attach to all pathway sections 12" (305mm), 18" (457mm), 24" (610mm) and 30" (762mm)

**WGBTMWFBL****WGSDDWF4BL**

Part Number	Part Description	Std. Pkg. Qty.	Std. Ctn. Qty.
WGBTMWFBL	The bottom waterfall provides 1.38" (35mm) bend radius control for cables transitioning down into the racks or cabinets from within the Wyr-Grid [®] Pathway. The waterfalls can be installed side-by-side increasing the overall width of the waterfall. Standard finish is black powder coat.	1	10
WGSDDWF4BL	The sidewall waterfall provides 3" (76mm) bend radius control for cables transitioning down into the racks or cabinets from the side of the Wyr-Grid [®] Pathway. Cable retaining posts ensure bend radius control as cables traverse from the horizontal into the vertical path. Plastic design offered in black color.	1	—

Wyr-Grid® Support Brackets

- Offered in various widths to accommodate pathways: 12" (305mm), 18" (457mm), 24" (610mm), and 30" (762mm)
- Standard finish is black powder coat
- Integral quick-clip retention
- Accommodates 1/2" or 12mm threaded rod



WGTB12BL



WGTB18BL



WGTB24BL



WGTB30BL



WGCB12BL



WGCB18BL



WGCB24BL



WGWMTB12BL



WGWMTB1830BL

Part Number	Part Description	Std. Pkg. Qty.	Std. Ctn. Qty.
Wyr-Grid® Trapeze Brackets			
WGTB12BL	Used to support 12" (305mm) wide Wyr-Grid® Pathway from the ceiling using a pair of 1/2" or 12mm threaded rod drops. Hardware for attaching to threaded rod sold separately.	1	5
WGTB18BL	Used to support 18" (457mm) wide Wyr-Grid® Pathway from the ceiling using a pair of 1/2" or 12mm threaded rod drops. Hardware for attaching to threaded rod sold separately.	1	5
WGTB24BL	Used to support 24" (610mm) wide Wyr-Grid® Pathway from the ceiling using a pair of 1/2" or 12mm threaded rod drops. Hardware for attaching to threaded rod sold separately.	1	5
WGTB30BL	Used to support 30" (762mm) wide Wyr-Grid® Pathway from the ceiling using a pair of 1/2" or 12mm threaded rod drops. Hardware for attaching to threaded rod sold separately.	1	5
Wyr-Grid® Cantilever Brackets			
WGCB12BL	Used to support the 12" (305mm) wide Wyr-Grid® Pathway along a wall. Integral retaining clip secures the pathway to the bracket. Mounting hardware for attaching to wall not included.	1	5
WGCB18BL	Used to support the 18" (457mm) wide Wyr-Grid® Pathway along a wall. Integral retaining clip secures the pathway to the bracket. Mounting hardware for attaching to wall not included.	1	5
WGCB24BL	Used to support the 24" (610mm) wide Wyr-Grid® Pathway along a wall. Integral retaining clip secures the pathway to the bracket. Mounting hardware for attaching to wall not included.	1	5
Wyr-Grid® Wall Mount Termination Brackets			
WGWMTB12BL	Used to support the end of the 12" (305mm) Wyr-Grid® Pathway against the wall. Mounting hardware for attaching to wall not included.	1	5
WGWMTB1830BL	Used to support the end of the 18" (457mm), 24" (610mm), or 30" (762mm) Wyr-Grid® Pathway against the wall. Mounting hardware for attaching to wall not included. Package contains 2 components needed to support the wider pathway sections.	1	5

Wyr-Grid® Mounting Brackets for FiberRunner® System

- Offered in various widths to accommodate pathways: 12" (305mm), 18" (457mm), 24" (610mm), and 30" (762mm)
- Integral quick-clip retention
- Accommodates 1/2" or 12mm threaded rod
- Standard finish is black powder coat



FRTBWG12BL



FRTBWG18BL



FRTBWG24BL



FRTBWG30BL



WG12FRTBBL



WG18FRTBBL



WG24FRTBBL



WG30FRTBBL



WGSTRKTBL

Part Number	Part Description	Std. Pkg. Qty.	Std. Ctn. Qty.
Wyr-Grid® Mounting Brackets for FiberRunner® System			
FRTBWG12BL	FiberRunner® QuikLock™ Threaded Rod Trapeze Bracket for Wyr-Grid® 12" (305mm) width. Used to support FiberRunner® 4x4 and 6x4 Channel above or below the Wyr-Grid® 12" Pathway using the same 1/2" or 12mm threaded rod used to support the WGTB12BL bracket. Hardware for attaching to threaded rod sold separately.	1	10
FRTBWG18BL	FiberRunner® QuikLock™ Threaded Rod Trapeze Bracket for Wyr-Grid® 18" (457mm) width. Used to support FiberRunner® 4x4, 6x4, and 12x4 Channel above or below the Wyr-Grid® 18" Pathway using the same 1/2" or 12mm threaded rod used to support the WGTB18BL bracket. Hardware for attaching to threaded rod sold separately.	1	10
FRTBWG24BL	FiberRunner® QuikLock™ Threaded Rod Trapeze Bracket for Wyr-Grid® 24" (610mm) width. Used to support FiberRunner® 4x4, 6x4, and 12x4 Channel above or below the Wyr-Grid® 24" Pathway using the same 1/2" or 12mm threaded rod used to support the WGTB24BL bracket. Hardware for attaching to threaded rod sold separately.	1	10
FRTBWG30BL	FiberRunner® QuikLock™ Threaded Rod Trapeze Bracket for Wyr-Grid® 30" (762mm) width. Used to support FiberRunner® 4x4, 6x4, 12x4, and 24x4 Channel above or below the Wyr-Grid® 30" Pathway using the same 1/2" or 12mm threaded rod used to support the WGTB30BL bracket. Quick mount clips, FRQMC24-X are not included for installing the 24x4 channel. These must be purchased separately. This bracket is on the same pitch as the Wyr-Grid® Bracket. Hardware for attaching to threaded rod sold separately.	1	10
WG12FRTBBL	Wyr-Grid® 12" (305mm) width FiberRunner® QuikLock™ Trapeze Bracket. Attaches to the Wyr-Grid® 12" (305mm) wide Pathway to support a secondary FiberRunner® 4x4 or 6x4 Channel above the Wyr-Grid® Pathway. Adjustable 6 9/16" to 9 7/8" over the top surface of the Wyr-Grid® Pathway.	1	—
WG18FRTBBL	Wyr-Grid® 18" (457mm) width FiberRunner® QuikLock™ Trapeze Bracket. Attaches to the Wyr-Grid® 18" (457mm) wide Pathway to support a secondary FiberRunner® 4x4 or 6x4 Channel above the Wyr-Grid® Pathway. Adjustable 6 9/16" to 9 7/8" over the top surface of the Wyr-Grid® Pathway.	1	—
WG24FRTBBL	Wyr-Grid® 24" (610mm) width FiberRunner® QuikLock™ Trapeze Bracket. Attaches to the Wyr-Grid® 24" (610mm) wide Pathway to support a secondary FiberRunner® 4x4 or 6x4 Channel above the Wyr-Grid® Pathway. Adjustable 6 9/16" to 9 7/8" over the top surface of the Wyr-Grid® Pathway.	1	—
WG30FRTBBL	Wyr-Grid® 30" (762mm) width FiberRunner® QuikLock™ Trapeze Bracket. Attaches to the Wyr-Grid® 30" (762mm) wide Pathway to support a secondary FiberRunner® 4x4 or 6x4 channel above the Wyr-Grid® Pathway. Adjustable 6 9/16" to 9 7/8" over the top surface of the Wyr-Grid® Pathway.	1	—
Wyr-Grid® Mounting Bracket for Strut			
WGSTRKTBL	Strut mounting clip assembly allows Wyr-Grid® Pathway to be attached directly to standard 1 5/8" wide strut structures. Contains support member, two clips and all hardware for assembly.	1	5

Wyr-Grid® Accessories

- Offered in three different heights: 2" (50mm), 4" (102mm), and 6" (152mm)
- Standard finish is black powder coat



WGSDWL2BL



WGSDWL4BL



WGSDWL6BL



WGINTBRC2BL



WGINTBRC4BL



WGINTBRC6BL



WGHRDWKTBL

Part Number	Part Description	Std. Pkg. Qty.	Std. Ctn. Qty.
Wyr-Grid® Pathway Snap-On Sidewalls			
WGSDWL2BL	Wyr-Grid® 2" (50mm) high Snap-On Sidewalls can be attached anywhere along the pathway where needed to retain cables.	1	40
WGSDWL4BL	Wyr-Grid® 4" (102mm) high Snap-On Sidewalls can be attached anywhere along the pathway where needed to retain cables.	1	40
WGSDWL6BL	Wyr-Grid® 6" (152mm) high Snap-On Sidewalls can be attached anywhere along the pathway where needed to retain cables.	1	40
Wyr-Grid® Pathway Intersection Bend Radius Controls			
WGINTBRC2BL	Wyr-Grid® 2" (50mm) high Snap-On Intersection Bend Radius Control provides 3" (76mm) bend radius control and can be installed without cutting or fabrication at tees, crosses, and right angle intersections.	1	—
WGINTBRC4BL	Wyr-Grid® 4" (102mm) high Snap-On Intersection Bend Radius Control provides 3" (76mm) bend radius control and can be installed without cutting or fabrication at tees, crosses, and right angle intersections.	1	—
WGINTBRC6BL	Wyr-Grid® 6" (152mm) high Snap-On Intersection Bend Radius Control provides 3" (76mm) bend radius control and can be installed without cutting or fabrication at tees, crosses, and right angle intersections.	1	—
Wyr-Grid® Hardware			
WGHRDWKTBL	The hardware kit is used when field fabricating a right angle, allowing large radii to be created by cutting the pathway, bending it, and securing it into a right angle. 12" (305mm) width requires 6 pieces to create a 15.8" radius. 18" (457mm) width requires 9 pieces to create a 24.4" radius. 24" (610mm) width requires 12 pieces to create a 33.4" radius. 30" (762mm) width requires 15 pieces to create a 41.5" radius.	1	10

StructuredGround™ Grounding System for Wyr-Grid® System

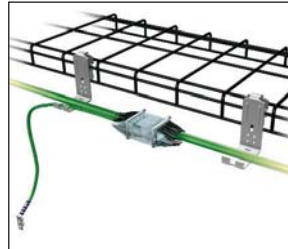

GACB brackets provide a convenient location to attach ground wire for grounding Wyr-Grid® System to the ground bar.

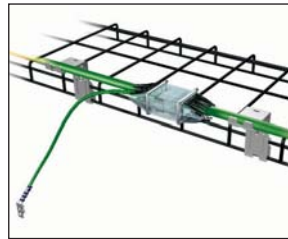

GACB brackets provide the flexibility to install grounding conductors above or below the Wyr-Grid® System.



GACB-2



GACB-3

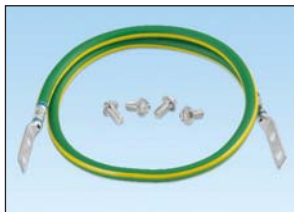

GACBJ68U

Part Number	Part Description	Std. Pkg. Qty.	Std. Ctn. Qty.
Grounding Cable Hanger Brackets			
GACB-2	Supports grounding conductors positioned below Wyr-Grid® Pathways and automatically makes bonding connection. Used with ladder rack and wire basket.	1	40
GACB-3	Supports grounding conductors positioned above Wyr-Grid® Pathways and automatically makes bonding connection. Used with ladder rack and wire basket.	1	40
GACBJ68U*	Auxiliary cable bracket jumper for bonding pathway sections; #6 AWG (16mm²); 8.0" (203mm) length; factory terminated on both ends with straight, two-hole, long barrel compression lugs; provided with .16 oz. (5cc) of antioxidant and four mounting screws.	1	40

*= Length in inches. Available in 8", 12", and 18" lengths.

Wyr-Grid® Tools and Hardware



HNLW12



FR716DR



WGCT-A



CD-WGCD-1



WGCT-HEAD



WGCT-M

Part Number	Part Description	Std. Pkg. Qty.	Std. Ctn. Qty.
Hardware			
HNLW12	1/2-13 hex nut and 1/2 lock washer for use in attaching trapeze brackets to threaded rod.	100	—
HNLW12M	12mm hex nut and 12mm lock washer for use in attaching trapeze brackets to threaded rod.	100	—
Tools			
FR716DR	7/16" nut driver for use with the FiberRunner®, GridRunner™, and Wyr-Grid® Systems.	1	10
WGCT-A	Battery powered cutting tool for cutting Wyr-Grid® Cable Trays, 2 – 18 volt lithium-ion batteries, and 115 volt, 60 Hz charger included.	1	—
CD-WGCD-1	Wyr-Grid® Replacement Cutting Die for the automatic cutting tool.	1	—
WGCT-HEAD	Wyr-Grid® Replacement Cutting Head for the automatic cutting tool.	1	—
WGCT-M	Manual cutting tool for cutting Wyr-Grid® Cable Trays. Weight: 5.4 lbs. (2.45 kg)	1	—

NOTES

GRIDRUNNER™ UNDERFLOOR CABLE ROUTING SYSTEM

Panduit provides an end-to-end solution for the physical layer infrastructure. The GridRunner™ Underfloor Cable Routing System is a high capacity, versatile, underfloor cable pathway. It is designed to route and manage copper cables, fiber optic trunk cables, and power cables beneath a raised floor system within data centers and service provider facilities.

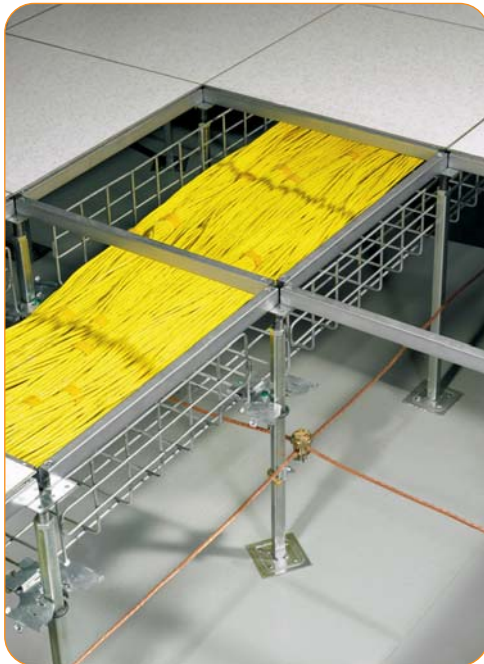

- Drop-in wire baskets are supplied in either 24" (600mm) or 48" (1200 mm) nominal lengths and require no cutting or deburring of sharp edges
- Drop-in wire baskets display all rounded edges, eliminating the opportunity for cables to get damaged during the initial installation and preventing risk of injury to the installer
- Pedestal bracket allows fast installation to raised floor pedestals (both round and square tube) with the use of a single tool and a single captured fastener
- Pedestal bracket allows for infinite height adjustability during installation
- Universal intersection component eliminates the need to field fabricate directional changes speeding specification and implementation
- Snap-in bend radius sidewalls provide bend radius control and are easily attached to the wire basket pathway
- Unique, adjustable, level change component allows the fast installation of vertical rises and descents without field modification or specification of special fittings
- Integral bonding feature of the GridRunner™ System ensures that all components are electrically bonded to each other as they are installed

The GridRunner™ Underfloor Cable Routing System ensures maximum network reliability and reduced cost of ownership. Robust, highly engineered components provide a strong pathway that supports maximum cable capacity over the lifetime of the data center, providing optimum cable protection and assuring network performance. Fast and easy to deploy, this scalable underfloor cable pathway solution reduces installation costs and speeds implementation of new services.

As part of the Panduit Data Center Solution, GridRunner™ Underfloor Cabling Routing System offers secure, reliable system integration and risk management within the physical infrastructure.

GridRunner™ Underfloor Cable Routing System Roadmap

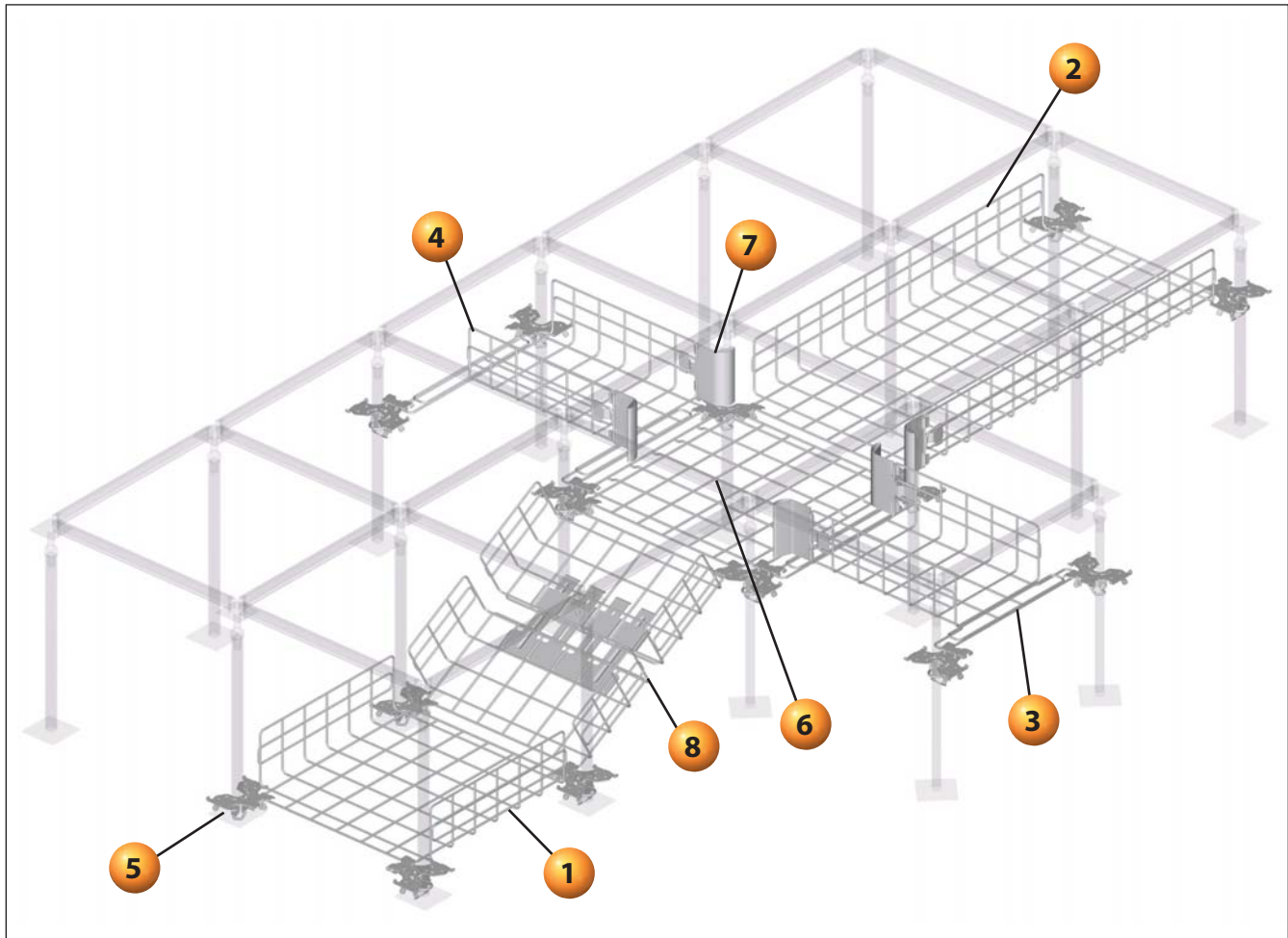

Additional sizes and accessories are available. See pages J.60 through J.61.

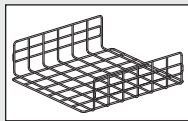

1 **GR21X6X24PG – GridRunner™**
21" Wide x 24" Long
Wire Basket Section
(page J.77)

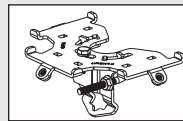

5 **GRPBPB – GridRunner™**
Pedestal Bracket
(page J.79)

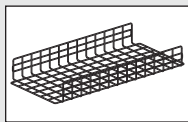

2 **GR21X6X48PG – GridRunner™**
21" Wide x 48" Long
Wire Basket Section
(page J.77)

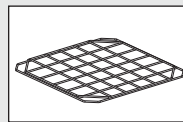

6 **GRFWC21PG – GridRunner™**
Universal Intersection
(page J.79)

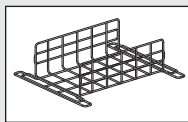

3 **GR12X6X24PG – GridRunner™**
12" Wide x 24" Long
Wire Basket Section
(page J.78)

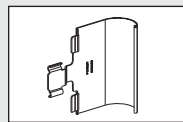

7 **GRBRC6PG – GridRunner™**
Bend Radius Control
Corner 6" High
(page J.79)

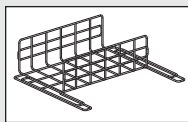

4 **GR12X6X24OSPG – GridRunner™**
12" Wide x 24" Long
Offset Wire Basket Section
(page J.78)

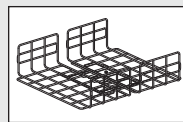

8 **GRLC21X6PG – GridRunner™**
21" Wide
Level Change Section
(page J.79)



GridRunner™ Underfloor Cable Routing System

Cable Fills for GridRunner™ Underfloor Cable Routing System

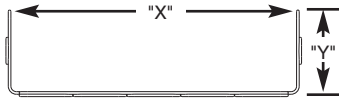

"X"	"Y"	Internal Area In. ²	Category 6A (SD) Diameter 6.1mm 0.240"	Category 6A Diameter 7.6mm 0.300"	Category 6 Diameter 6.1mm 0.240"
			50% Fill	50% Fill	50% Fill
12.0	4.0	48.0	531	340	531
12.0	6.0	72.0	796	509	796
21.7	4.0	86.8	959	614	959
21.7	6.0	130.3	1440	922	1440

The above cable dimensions represent the nominal Panduit cable diameter per performance level. For specific cable fill information based on specific part numbers, please contact Panduit customer service.

GridRunner™ Wire Baskets



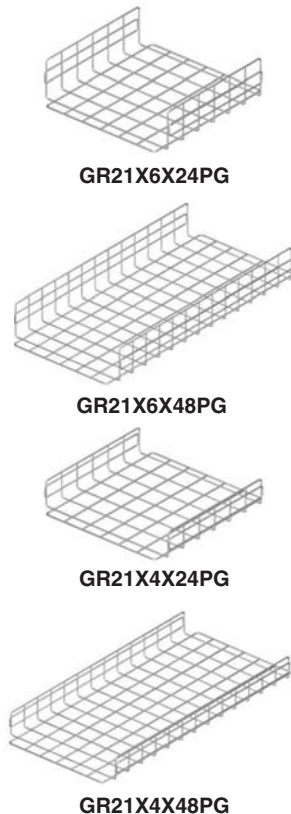

- Drop-in wire basket sections are supplied in two widths (21" and 12"), two depths (4" and 6"), and two lengths (24" and 48")
- Feature all rounded edges
- Require no cutting or deburring of sharp edges
- Accommodate 24" x 24" and 600mm x 600mm raised floor grids
- Made from pre-galvanized steel wire

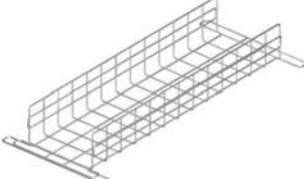
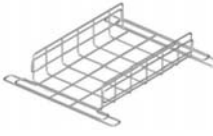

Part Number	Part Description	Std. Pkg. Qty.	Std. Ctn. Qty.
21" Wide Wire Basket Sections			
GR21X6X24PG	21"W x 6"D x 24"L section used to carry cables horizontally throughout the system. Attaches to GRPBPG pedestal bracket to provide secure connection and electrical bond to raised floor pedestal.	—	2
GR21X6X48PG	21"W x 6"D x 48"L section used to carry cables horizontally throughout the system. Attaches to GRPBPG pedestal bracket to provide secure connection and electrical bond to raised floor pedestal.	—	2
GR21X4X24PG	21"W x 4"D x 24"L section used to carry cables horizontally throughout the system. Attaches to GRPBPG pedestal bracket to provide secure connection and electrical bond to raised floor pedestal.	—	2
GR21X4X48PG	21"W x 4"D x 48"L section used to carry cables horizontally throughout the system. Attaches to GRPBPG pedestal bracket to provide secure connection and electrical bond to raised floor pedestal.	—	2

Table continues on page J.78

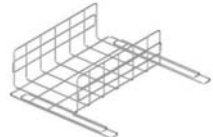
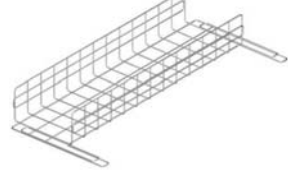
GridRunner™ Wire Baskets (continued)

Part Number	Part Description	Std. Pkg. Qty.	Std. Ctn. Qty.
12" Wide Wire Basket Sections			
 GR12X6X24PG	12"W x 6"D x 4"L section used to carry cables horizontally throughout the system. Centers the basket between pedestal supports. Attaches to GRPBPG pedestal bracket to provide secure connection and electrical bond to raised floor pedestal.	—	2
 GR12X6X48PG	12"W x 6"D x 48"L section used to carry cables horizontally throughout the system. Centers the basket between pedestal supports. Attaches to GRPBPG pedestal bracket to provide secure connection and electrical bond to raised floor pedestal.	—	2
 GR12X4X24PG	12"W x 4"D x 24"L section used to carry cables horizontally throughout the system. Centers the basket between pedestal supports. Attaches to GRPBPG pedestal bracket to provide secure connection and electrical bond to raised floor pedestal.	—	2
 GR12X4X48PG	12"W x 4"D x 48"L section used to carry cables horizontally throughout the system. Centers the basket between pedestal supports. Attaches to GRPBPG pedestal bracket to provide secure connection and electrical bond to raised floor pedestal.	—	2
12" Wide Offset Wire Basket Sections			
 GR12X6X24OSPG	12"W x 6"D x 24"L section used to carry cables horizontally throughout the system. Offsets 12" basket towards one side. Attaches to GRPBPG pedestal bracket to provide secure connection and electrical bond to raised floor pedestal.	—	2
 GR12X6X48OSPG	12"W x 6"D x 48"L section used to carry cables horizontally throughout the system. Offsets 12" basket towards one side. Attaches to GRPBPG pedestal bracket to provide secure connection and electrical bond to raised floor pedestal.	—	2
 GR12X4X24OSPG	12"W x 4"D x 24"L section used to carry cables horizontally throughout the system. Offsets 12" basket towards one side. Attaches to GRPBPG pedestal bracket to provide secure connection and electrical bond to raised floor pedestal.	—	2
 GR12X4X48OSPG	12"W x 4"D x 48"L section used to carry cables horizontally throughout the system. Offsets 12" basket towards one side. Attaches to GRPBPG pedestal bracket to provide secure connection and electrical bond to raised floor pedestal.	—	2

GridRunner™ Pedestal Bracket

- Allows the wire basket sections to be supported on three sides of a single support bracket
- Forms a mechanical electrical bond to the raised floor pedestal
- Optimized for use with both 7/8" square and 1" diameter raised floor pedestals
- Made from pre-galvanized steel



GRPBPG



GRPB12PG

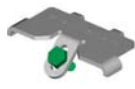

GRCLAMPPG-X

Part Number	Part Description	Std. Pkg. Qty.	Std. Ctn. Qty.
Pedestal Bracket			
GRPBPG	Pre-assembled bracket quickly attaches to all 7/8" square and 1" diameter raised floor pedestals. Provides secure mounting point on three sides of the pedestal for all basket sections and an electrical bond to the pedestal. Use 7/16" nut driver to assemble to pedestal. Requires use of pedestal clamp GRCLAMPPG-X to attach wire baskets, universal intersection, and level change sections to pedestal bracket.	1	10
GRPB12PG	Pre-assembled bracket quickly attaches to all 1 – 2" diameter raised floor pedestals. Provides secure mounting point on three sides of the pedestal for all basket sections and an electrical bond to the pedestal. Use 7/16" nut driver to assemble to pedestal. Requires use of pedestal clamp GRCLAMPPG-X to attach wire baskets, universal intersection, and level change sections to pedestal bracket.	1	10
Pedestal Clamp			
GRCLAMPPG-X	Used in conjunction with pedestal bracket GRPBPG to fasten wire basket sections to the pedestal.	10	100

GridRunner™ Accessories



GRBRC4PG



GRBRC6PG

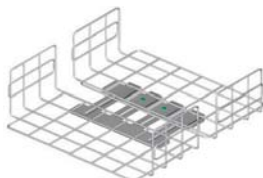

GRLC21X6PG

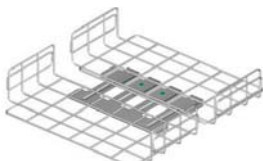

GRLC21X4PG

Part Number	Part Description	Std. Pkg. Qty.	Std. Ctn. Qty.
Universal Intersection			
GRFWC21PG	Mounts to GRPBPG pedestal bracket. Use to create four way cross, horizontal tee, right angles, and transitions to other size basket sections.	1	—
Bend Radius Control Corners			
GRBRC4PG	Bend radius control corner for 4" deep basket sections. Device snaps into corners to provide 1.5" (38mm) bend radius control. Sheet metal construction.	1	10
GRBRC6PG	Bend radius control corner for 6" deep basket sections. Device snaps into corners to provide 1.5" (38mm) bend radius control. Sheet metal construction.	1	10
21" Wide Level Change Sections			
GRLC21X6PG	21"W x 6"D level change section used to create vertical offsets up to 12". Attaches to GRPBPG pedestal bracket to provide secure connection and electrical bond to raised floor support pedestal.	1	—
GRLC21X4PG	21"W x 4"D level change section used to create vertical offsets up to 12". Attaches to GRPBPG pedestal bracket to provide secure connection and electrical bond to raised floor support pedestal.	1	—

NOTES

SURFACE RACEWAY

Pan-Way® Surface Raceway Systems offer a wide variety of non-metallic surface raceway solutions. All are designed for routing, protecting, and concealing high-performance copper, voice, video, fiber optic, and power cabling. Pan-Way® Surface Raceway Systems provide:



- Aesthetically pleasing profiles and colors to match your cabling needs
- Tamper-resistant designs to prevent unauthorized access
- Fully compliant bend radius control fittings to insure maximum cable performance
- Ease of installation, modification, and additions for the overall lowest installed cost

Panduit surface raceway provides you with a variety of choices when selecting your data and electrical terminations. All raceway systems accept an assortment of faceplates including NEMA standard 70mm screw-on faceplates or superior Panduit snap-on faceplates.

As part of the Panduit Enterprise Solution, Pan-Way® Surface Raceway offers safe and secure routing integration within the physical infrastructure.



PANDUIT[®] PAN-WAY[®]

NON-METALLIC SURFACE RACEWAY SOLUTIONS

Pan-Way[®] Non-Metallic Surface Raceway is available in single-channel and multi-channel versions, providing maximum flexibility for routing, protecting, concealing, and terminating high-performance copper, voice, video, fiber optic, and power cabling. They are aesthetically pleasing, lightweight, tamper-resistant and offer bend radius control fittings. Panduit non-metallic raceways provide a variety of choices when selecting data and power terminations, accept NEMA standard 70mm faceplates, and work with all Panduit[®] Mini-Com[®] Modules for complete connectivity possibilities.

Pan-Way[®] Single Channel Raceway includes LD, LDPH, LDS, PD, and OFR which are available in low voltage and/or power rated versions. All single channel raceways include a full complement of fittings for standard, bend radius control, and power rated applications. Office Furniture Raceway also includes a full complement of fittings, accessories, and termination options creating a cost-effective furniture routing solution.

Pan-Way[®] Multi-Channel Raceway includes TG-70, T-70/Twin-70, T-45, LD2P10, and Cove. All multi-channel raceways provide solutions for routing power and data cabling, offer 1 inch bend radius control fittings (TG-70 offers a 1.6 bend radius control), accept NEMA standard 70mm faceplates for multiple termination options and transition to other Panduit non-metallic surface raceways.

*Full product offerings available in Electrical Solutions Catalog.

PANDUIT® PAN-WAY®

NON-METALLIC SURFACE RACEWAY SOLUTIONS

Pan-Way® Snap-On Faceplates mount directly to Cove, TG-70, T-70, Twin-70, Pan-Way® Fast-Snap™ Boxes and Pan-Pole™ Power and Communication Poles and install faster than conventional screw-on faceplates. They install without the use of screws providing faster installation and superior aesthetics. Snap-on communication faceplates are available in horizontal or vertical sloped outlet configurations and the snap-on electrical faceplates are available in 106 duplex and rectangular styles.



Pan-Way® Surface Mount Outlet Boxes are available for both power and communication applications. Fast-Snap™ Boxes assemble without the use of screws and accept Pan-Way® Snap-On Faceplates. All surface mount boxes are compatible with Pan-Way® LD, LDPH, LD2P10, and T-45 Raceway Systems.

Pan-Pole™ Power and Communication Poles provide industry-leading solutions for cable routing in the open office environment. They are available with pre-terminated electrical outlets with divided channel for power and communication applications or as an open channel communication pole. Pan-Pole™ Power and Communication Poles accept NEMA standard 70mm screw-on faceplates or superior Pan-Way® Snap-On Faceplates.

As part of the Panduit Enterprise Solution, Pan-Way® Non-Metallic Surface Raceway offers safe and secure routing integration within the physical infrastructure.

*Full product offerings available in Electrical Solutions Catalog.

Office Furniture Raceway Roadmap



Note: Office furniture raceway is designed to blend with its environment. Shown in white on office slate furniture for illustration purposes only.

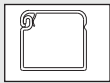

1 OFR20**6 – Office Furniture Raceway (page K.8)

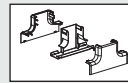

L OFR20MPT** – Mid Panel Tee Fitting (page K.10)



A OFCR70**6 – Corner Raceway Base (page K.8)



M OFR20WE** – Wall Entrance Fitting (page K.10)

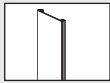

B OFCRC70**6 – Corner Raceway Cover (page K.8)

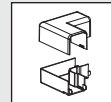

N OFR20RA** – Right Angle Fitting (page K.10)

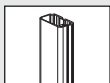

C OFVR5**6 – Vertical Raceway (page K.8)

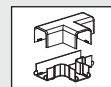

O OFR20T** – Tee Fitting (page K.10)

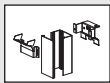

D OFR20CP**8 – Communication Pole (page K.9)

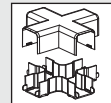

P OFR20CR** – Cross Fitting (page K.10)

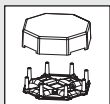

E OFR20OFCR70**4 – Four Cubicle Drop Fitting (page K.9)

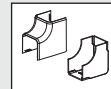

Q OFR20IC** – Inside Corner Fitting (page K.11)



F OFR20OFCR70**2 – Two Cubicle Drop Fitting (page K.9)

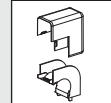

R OFR20OC** – Outside Corner Fitting (page K.11)

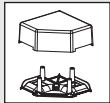

G OFR20OFCR70**1 – One Cubicle Drop Fitting (page K.9)



S OFR20CC** – Coupler Fitting (page K.11)

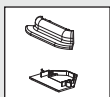

H OFCR70EC** – End Cap Fitting (page K.10)

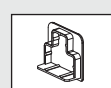

T OFR20EC** – End Cap Fitting (page K.11)

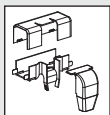

J OFR20SO** – Spill-Over Fitting (page K.10)

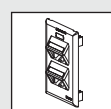

U OF70FV4** – Vertical Sloped Communication Snap-On Faceplate (page K.11)

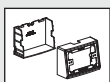

K OFR20DMB** – Desk Mount Box (page K.10)



V OF70FH4** – Horizontal Sloped Communication Snap-On Faceplate (page K.11)

Office Furniture Configurations

Exploded View 1

	Components Required	See page
A.	OFR20OFCR70**4 = Four Cubicle Drop Fitting.	K.9
B.	OFCR70**6 = Corner Raceway Base.	K.8
C.	OFCR70EC = End Cap Fitting.	K.10
D.	OF70FV4 = Vertical Sloped Communication Snap-On Faceplate.	K.11
E.	Mini-Com [®] Modules.	Section B
F.	OFCRC70**6 = Corner Raceway Cover.	K.8

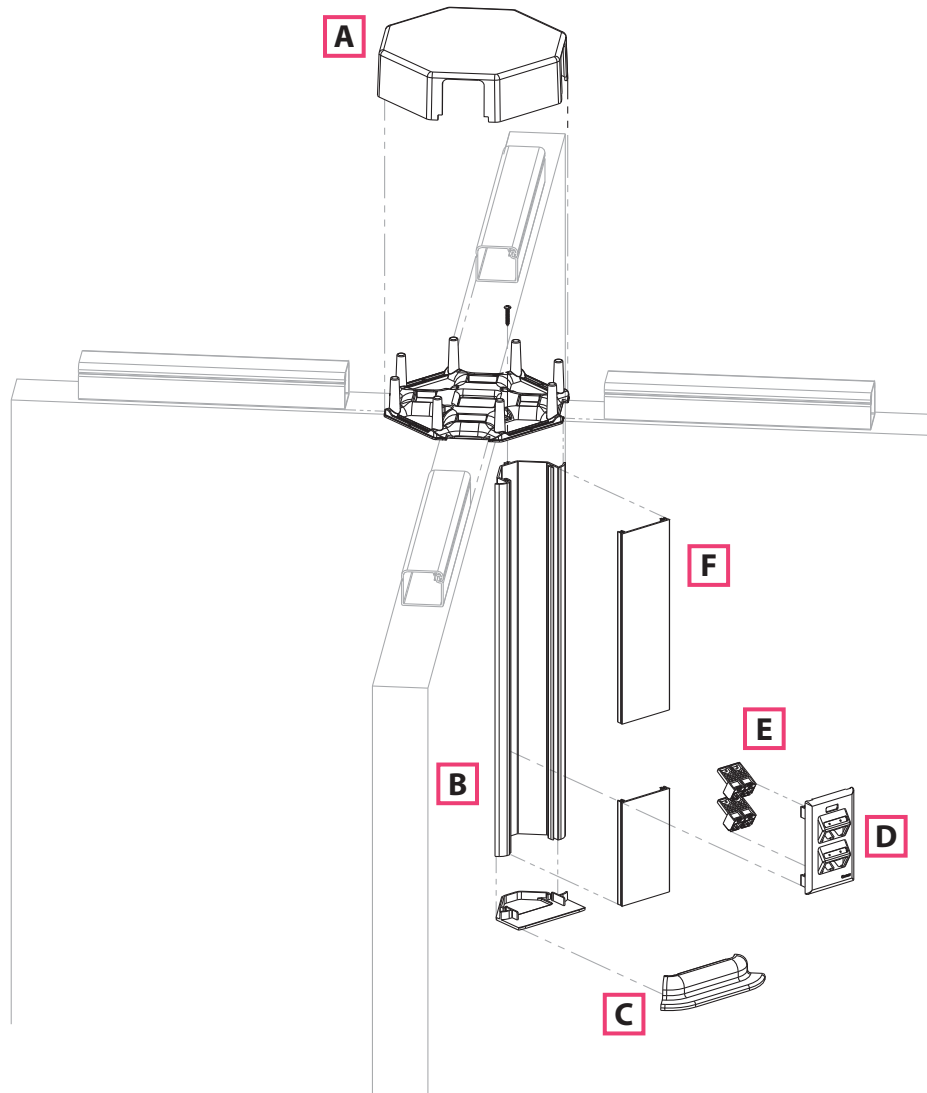

Office Furniture Configurations (continued)

Exploded View 2

	Components Required	See page
A.	OFR20SO** = Spill-Over Fitting.	K.10
B.	OFVR5**6 = Vertical Raceway.	K.8
C.	OFR20DMB = Desk Mount Box.	K.10
D.	Mini-Com® Modules.	Section B
E.	OF70FH4** = Horizontal Sloped Communication Snap-On Faceplate.	K.11

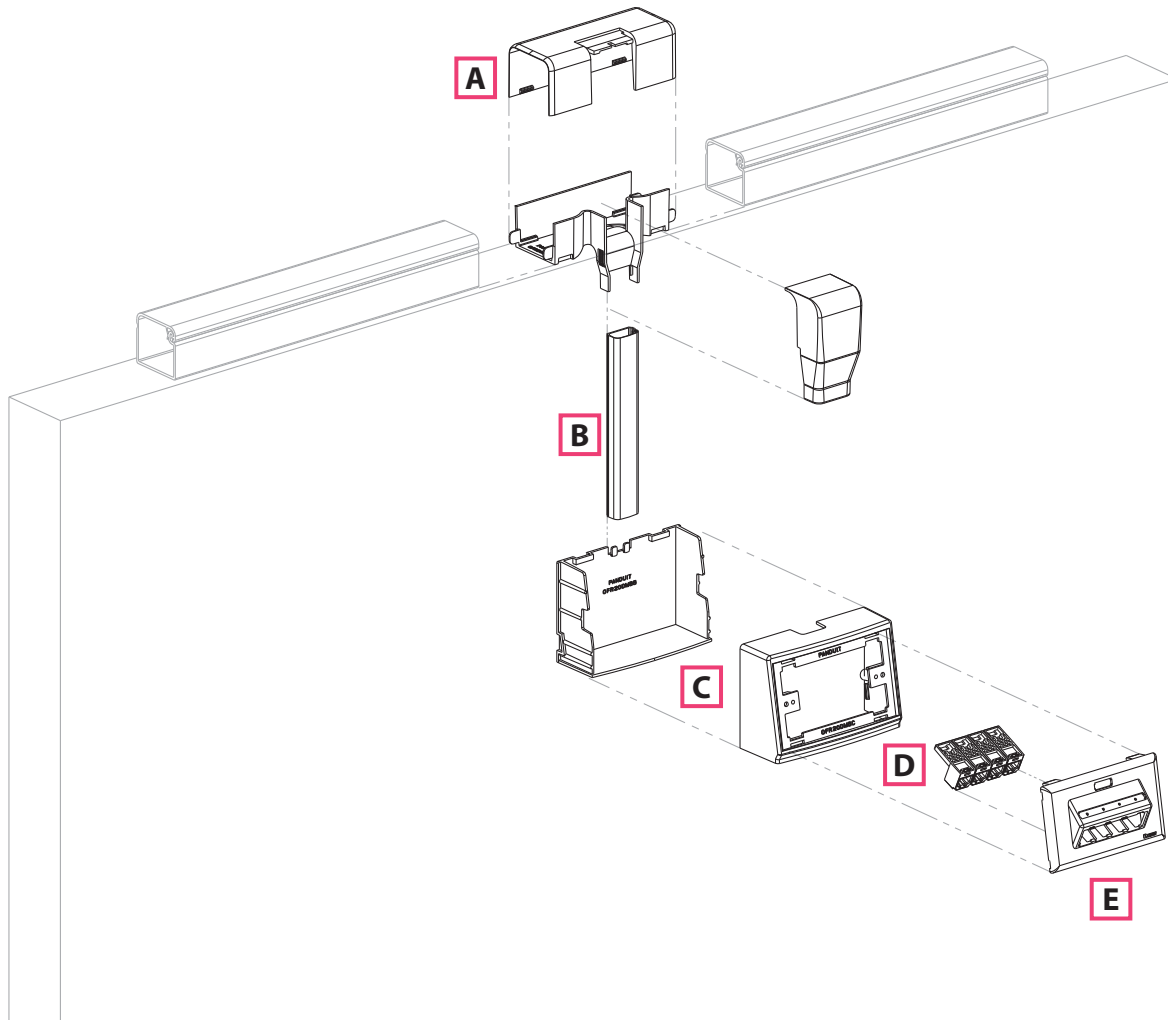



Pan-Way® Office Furniture Raceway System

- UL listed in accordance with UL-5C requirements for Class 2 Communication Cable Management Systems
- Maintains bend radius control throughout the entire office furniture raceway system as required by TIA/EIA-568-B and 569-B
- Faceplates are compliant with the labeling requirements of the TIA/EIA-606-A standard
- Robust design and tamper resistant closure increases product stability and prevents damage to cabling during and after installation
- Product supplied with adhesive backing for fast and easy installation
- Creates a virtually invisible solution for routing data cables on panels from all common manufacturers with a top cap width between 1.88" and 2.30"
- Designed for use with Pan-Net® Connectivity, also accepts all common manufacturers' connectivity with use of a NEMA standard 70mm faceplate or module frame

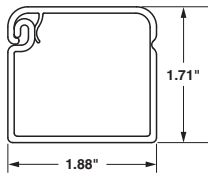

OFFICE FURNITURE RACEWAY
Internal Area = 2.31 Sq. In.



Office Beige (OB)



Office Gray (OG)

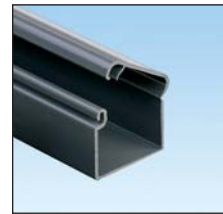

Office Slate (OS)



Medium Tone (MT)



OFR20

Part Number	Part Description	Raceway Size	Color‡	Length (Ft.)	Std. Pkg. Qty.	Std. Ctn. Qty.
OFR20OB6	One-piece single channel low voltage raceway with adhesive tape backing for data cable routing along top of modular furniture partitions. Available in 6' lengths.	1.88" x 1.71" (48.0mm x 44.0mm)	Office Beige	6	6	48
OFR20OB8	One-piece single channel low voltage raceway with adhesive tape backing for data cable routing along top of modular furniture partitions. Available in 8' lengths.	1.88" x 1.71" (48.0mm x 44.0mm)	Office Beige	8	8	64

‡For other colors, replace OB (Office Beige) with OS (Office Slate), OG (Office Gray), or MT (Medium Tone).
Order number of feet required in multiples of standard carton quantity.



Pan-Way® Office Furniture Raceway Fittings

- Office furniture raceway fittings have been designed to maintain the TIA/EIA required 1" minimum bend radius for high performance copper and fiber optic cabling systems



OFCR70



OFCRC70



OFVR5

Part Number	Part Description	Labels Required	Color‡	Std. Pkg. Qty.	Std. Ctn. Qty.
OFCR70OB6	Office furniture corner raceway base. Used to terminate low voltage data cabling in the corner at the intersection of modular office furniture panels. Accepts 70mm standard faceplates. Available in 6' lengths.	—	Office Beige	6	48
OFCRC70OB6	Office furniture corner raceway cover. Available in 6' lengths.	—	Office Beige	6	48
OFVR5OB6	Office furniture vertical raceway. One-piece single channel raceway used to connect OFR20**6 or OFR20**8 to desk mount box (OFR20DMB**) and must be used with OFR20SO** or OFR20DSO**. Available in 6' lengths.	—	Office Beige	6	120

‡For other colors, replace OB (Office Beige) with OS (Office Slate), OG (Office Gray), or MT (Medium Tone).



Pan-Way® Office Raceway Fittings (continued)

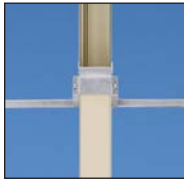

OFR20CP



OFR20OFCR70**4



OFR20OFCR70**2



OFR20OFCR70**1



OFR20OFCR70**1P



OFR20OFCR70**2P



OFR20OFCR70**4P

Part Number	Part Description	Labels Required	Color‡	Std. Pkg. Qty.	Std. Ctn. Qty.
OFR20CPOB8	Communication pole. Allows for data cable entry into office furniture raceway from suspended ceiling. 8' pole allows maximum 7' distance from top of furniture partition to ceiling. Must be used with OFR20MPT**. Note: Not intended for use at intersection of furniture panels.	—	Office Beige	1	—
OFR20OFCR70OB4	Four cubicle drop fitting. Allows the transition from office furniture raceway run horizontally along partition wall to office furniture corner raceway mounted vertically in four cubicles at the intersection of partitions. Fitting maintains 1" minimum bend radius of cabling. Supplied with adhesive tape.	—	Office Beige	1	10
OFR20OFCR70OB2	Two cubicle drop fitting. Allows the transition from office furniture raceway run horizontally along partition wall to office furniture corner raceway mounted vertically in two cubicles at the intersection of partitions. Fitting maintains 1" minimum bend radius of cabling. Supplied with adhesive tape.	—	Office Beige	1	10
OFR20OFCR70OB1	One cubicle drop fitting. Allows the transition from office furniture raceway run horizontally along partition wall to office furniture corner raceway mounted vertically in one cubicle at the intersection of partitions. Fitting maintains 1" minimum bend radius of cabling. Supplied with adhesive tape.	—	Office Beige	1	10
OFR20OFCR70OB1P	One cubicle drop bypass fitting. Allows the transition from office furniture raceway run horizontally along partition wall, around existing furniture pole, to office furniture corner raceway mounted vertically in one cubicle at the intersection of partitions. Fitting maintains 1" minimum bend radius of cabling. Supplied with adhesive tape.	—	Office Beige	1	10
OFR20OFCR70OB2P	Two cubicle drop bypass fitting. Allows the transition from office furniture raceway run horizontally along partition wall, around existing furniture pole, to office furniture corner raceway mounted vertically in two cubicles at the intersection of partitions. Fitting maintains 1" minimum bend radius of cabling. Supplied with adhesive tape.	—	Office Beige	1	10
OFR20OFCR70OB4P	Four cubicle drop bypass fitting. Allows the transition from office furniture raceway run horizontally along partition wall, around existing furniture pole, to office furniture corner raceway mounted vertically in four cubicles at the intersection of partitions. Fitting maintains 1" minimum bend radius of cabling. Supplied with adhesive tape.	—	Office Beige	1	10

‡For other colors, replace OB (Office Beige) with OS (Office Slate), OG (Office Gray), or MT (Medium Tone).

Table continues on page K.10

**Pan-Way[®] Office Raceway Fittings (continued)****OFRCR70EC****OFR20SO****OFR20DSO****OFR20DMB****OFR20MPT****OFR20WE****OFR20RA****OFR20T****OFR20CR**

Part Number	Part Description	Labels Required	Color‡	Std. Pkg. Qty.	Std. Ctn. Qty.
OFRCR70ECOB	Corner raceway end cap fitting. Opening allows cord passage through fitting such as monitor and keyboard cables. Supplied with adhesive tape.	—	Office Beige	1	10
OFR20SOOB	Spill-over fitting. Allows transition from office furniture raceway run horizontally along partition wall to office furniture vertical raceway in one location. Adjustable fitting maintains 1" minimum bend radius of cabling and works with various panel widths between 1.88"–2.30" (47.7mm – 58mm). Supplied with adhesive tape.	—	Office Beige	1	10
OFR20DSOOB	Double spill-over fitting. Fitting is used to spill over both sides of the furniture partitions at the same location. Incorporates a built-in, yet removable end cap that eliminates the need for additional raceway and fittings to terminate the pathway.	—	Office Beige	1	10
OFR20DMBOB	Desk mount box. Box accepts office furniture snap-on faceplates as well as 70mm NEMA standard screw-on faceplates. Designed for use with OFVR5**6 raceway and OFR20SO**, OFR20DSO** spill-over fittings. Supplied with adhesive tape.	—	Office Beige	1	10
OFR20MPTOB	Mid-panel tee fitting. Used to connect communication pole to office furniture raceway run horizontally along partition wall. Supplied with adhesive tape. Note: not intended for use at intersection of furniture panels.	—	Office Beige	1	10
OFR20WEOB	Wall entrance fitting. Allows entry from wall to office furniture raceway run horizontally along partition walls. Fitting includes bend radius protection and trim plate to cover wall opening. Requires minimum wall opening of 4.5"W x 3.0"H (114.3mm x 76.2mm). Supplied with adhesive tape.	—	Office Beige	1	10
OFR20RAOB	Right angle fitting. Used to join sections of office furniture raceway at 90° flat junction. Supplied with adhesive tape.	—	Office Beige	1	10
OFR20TOB	Tee fitting. Used to create an undivided tee junction between sections of office furniture raceway. Supplied with adhesive tape.	—	Office Beige	1	10
OFR20CROB	Cross fitting. Used to join sections of office furniture raceway at four corners. Supplied with adhesive tape.	—	Office Beige	1	10

‡For other colors, replace OB (Office Beige) with OS (Office Slate), OG (Office Gray), or MT (Medium Tone).



Pan-Way® Office Raceway Fittings (continued)

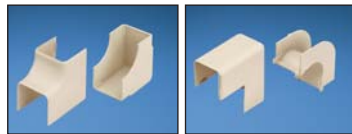

OFR20IC

OFR20OC



OFR20CC



OFR20LC



OFR20EC

OF70FH2

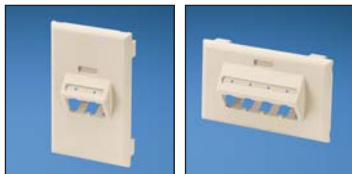

OF70FV2

OF70FH4

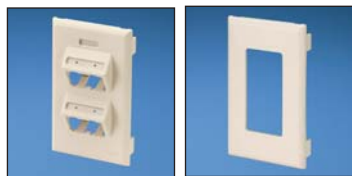

OF70FV4

OF70PG



OF70P

T70SDB-X

Part Number	Part Description	Labels Required	Color‡	Std. Pkg. Qty.	Std. Ctn. Qty.
OFR20ICOB	Inside corner fitting. Used to join sections of office furniture raceway at inside corner. Supplied with adhesive tape.	—	Office Beige	1	10
OFR20OCOB	Outside corner fitting. Used to join sections of office furniture raceway at outside corner. Supplied with adhesive tape.	—	Office Beige	1	10
OFR20CCOB-X	Coupler fitting. For use with office furniture raceway.	—	Office Beige	10	100
OFR20LCOB	Long coupler fitting (with base). Used to bridge office furniture raceway between panel sections. Can also be used to fill void left by spill-over fitting, when furniture partitions are reconfigured. Supplied with adhesive tape.	—	Office Beige	1	10
OFR20ECOB	End cap fitting. Used to terminate office furniture raceway. Supplied with adhesive tape.	—	Office Beige	1	10
OF70FH2OB	Snap-on single gang horizontal sloped communication faceplate. Accepts up to two Panduit® Mini-Com® Modules (not included). No additional mounting hardware required. TIA/EIA-606-A compliant.	One 1-Port One 2-Port	Office Beige	1	10
OF70FV2OB	Snap-on single gang vertical sloped communication faceplate. Accepts up to two Panduit® Mini-Com® Modules (not included). No additional mounting hardware required. TIA/EIA-606-A compliant.	One 1-Port One 2-Port	Office Beige	1	10
OF70FH4OB	Snap-on single gang horizontal sloped communication faceplate. Accepts up to four Panduit® Mini-Com® Modules (not included). No additional mounting hardware required. TIA/EIA-606-A compliant.	One 1-Port One 4-Port	Office Beige	1	10
OF70FV4OB	Snap-on single gang vertical sloped communication faceplate. Accepts up to four Panduit® Mini-Com® Modules (not included). No additional mounting hardware required. TIA/EIA-606-A compliant.	One 1-Port One 4-Port	Office Beige	1	10
OF70PGOB	Snap-on single gang rectangular communication faceplate. In communication applications, covers one standard rectangular communication module frame. No additional mounting hardware required.	One 1-Port One 4-Port	Office Beige	1	—
OF70POB	Snap-on single gang 106 duplex communication faceplate. In communication applications, covers one standard 106 duplex communication module frame. No additional mounting hardware required.	One 1-Port One 4-Port	Office Beige	1	—
T70SDB-X	Standard faceplate bracket. Used to mount NEMA standard 70mm single gang screw-on faceplates. Can be used with T-70, Twin-70, TG-70 raceway and Pan-Pole™ Communication Pole.	One 1-Port One 4-Port	Gray	10	—

‡For other colors, replace OB (Office Beige) with OS (Office Slate), OG (Office Gray), or MT (Medium Tone).

Cable Fill Capacities for Office Furniture

This information is to be used as a guide in selecting the proper size raceway. The maximum amounts may vary according to the cable installation methods, straightness of cables, etc.

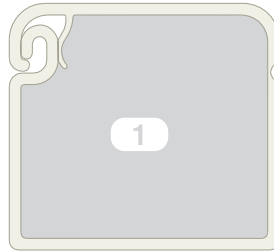

A = 2.31 in.²

Cable fill #1: Open channel without devices

SPEC = 40% cable fill – The recommended design in cable capacity, leaves room for future moves, adds, and changes.

MAX for Data = 60% cable fill – The maximum cable quantity based on cable interweaving and packing factors.

Raceway Type and Configuration	Fill Area (in ²)	Electrical Cables			Data Grade Cables				Cat. 6A (SD)		Audio/Video		Fiber Optic Cable	
		14 AWG	12 AWG	10 AWG	24 AWG/UTP CM				6A (SD)		RG6		2 Strand	
		THHN/T90			Cat. 6		Cat. 6A		DIA. = 0.240		DIA. = 0.275		DIA. = 0.175	
		0.111	0.130	0.164	DIA. = 0.240		DIA. = 0.300		DIA. = 0.240		DIA. = 0.275		DIA. = 0.175	
		FILL			FILL		FILL		FILL		FILL		FILL	
		MAX	MAX	MAX	SPEC	MAX	SPEC	MAX	SPEC	MAX	SPEC	MAX	SPEC	MAX
OFR20	2.3	—	—	—	20	30	13	19	20	30	15	23	38	57

AWG dimensions represent typical outer cable diameter in inches.

The above cable diameters represent the nominal Panduit cable diameter per performance level. For specific cable fill information based on specific part numbers, please contact Panduit customer service.

NOTES

A.
System
Overview

B.
Copper
Systems

C.
Fiber
Optic
Systems

D.
Power
over
Ethernet

E.
Zone
Cabling

F.
Wireless

G.
Outlets

H.
Media
Distribution

I.
Physical
Infrastructure
Management

J.
Overhead &
Underfloor
Routing

K.
Surface
Raceway

L.
Cabinets,
Racks &
Cable
Management

M.
Grounding &
Bonding

N.
Industrial

O.
Labeling &
Identification

P.
Cable
Management
Accessories

Q.
Index

LD Surface Raceway Roadmap

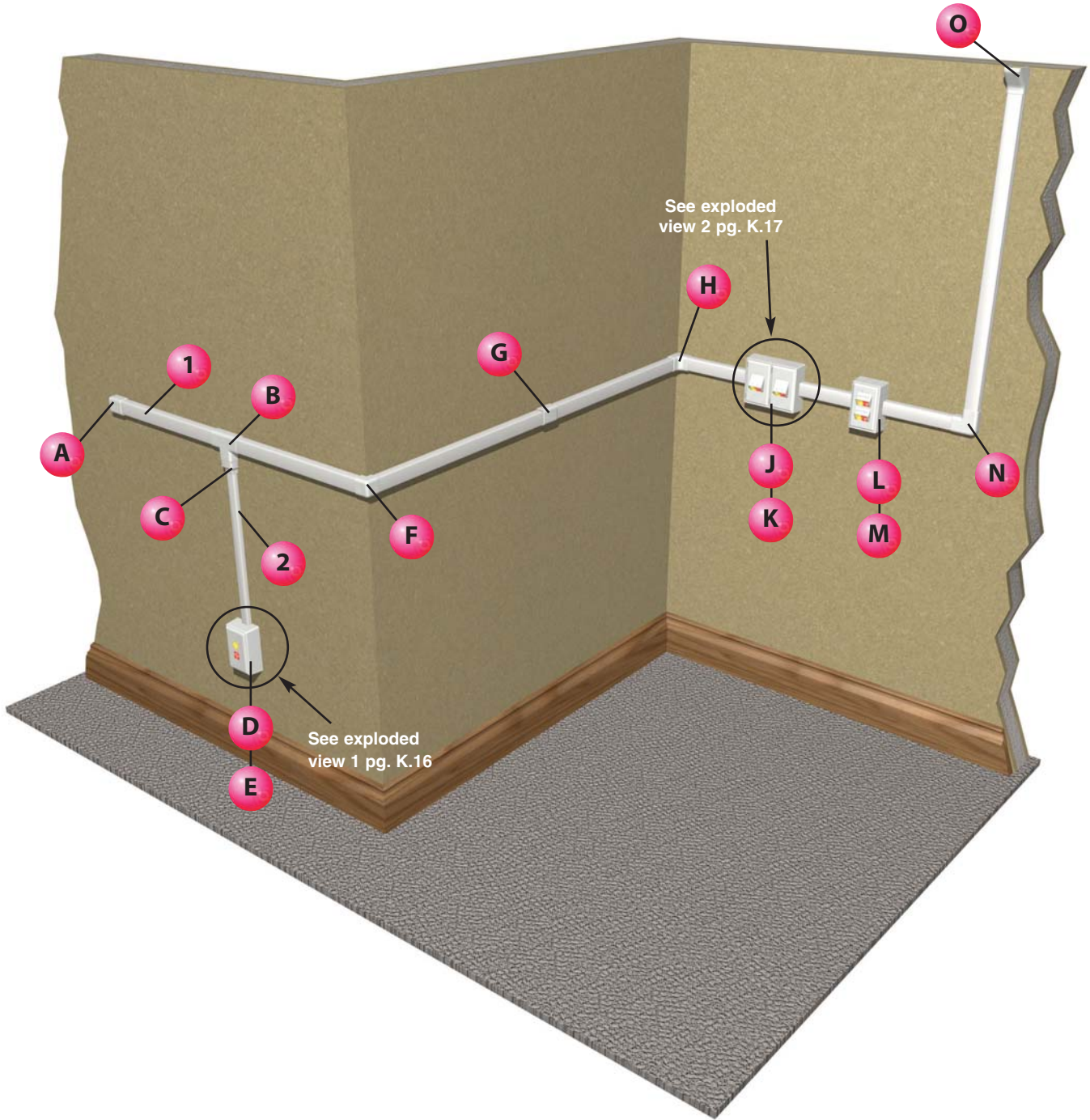

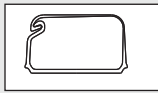

1 LD10 Raceway
(page K.18)

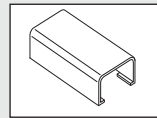

G CF10** - Coupler Fitting
(page K.19)

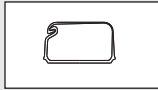

2 LD5 Raceway
(page K.18)

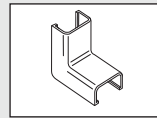

H ICF10** - Inside Corner Fitting
(page K.19)

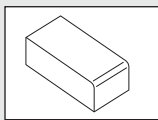

A ECF10** - End Cap Fitting
(page K.19)

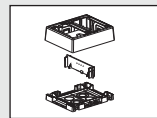

J JBP2FS** - Fast-Snap™ Double
Gang Power Rated Surface
Mount Outlet Box
(page K.26)

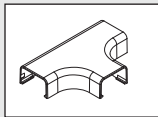

B TF10** - Tee Fitting
(page K.19)

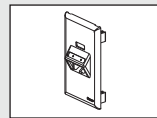

K UIT70FV2** - Ultimate ID™
Two-Position Sloped Vertical
Snap-On Faceplates
(page K.22)

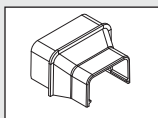

C RF10X5** - Reducer Fitting
(page K.19)

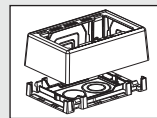

L JB1FS** - Fast-Snap™ Single
Gang Surface Mount Outlet Box
(page K.26)

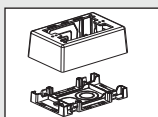

D JBX3510** - Single Gang
Two-Piece Snap-Together Box
(page K.25)

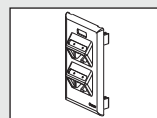

M UIT70FV4** - Ultimate ID™
Four-Position Sloped Vertical
Snap-On Faceplates
(page K.22)

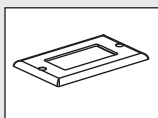

E CPG** - Single Gang Rectangular
Screw-On Faceplate
(page K.23)

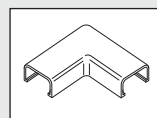

N RAF10** - Right Angle Fitting
(page K.19)

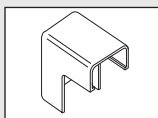

F OCF10** - Outside Corner Fitting
(page K.19)

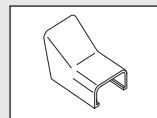

O DCF10** - Drop Ceiling/Entrance
End Fitting
(page K.19)

LD Configurations

Exploded View 1

	Components Required	See page
A.	CPG = Single Gang Rectangular Screw-On Faceplate (screws included).	K.23
B.	CFG2 = Mini-Com [®] Module Frame – 2-Port.	G.16
C.	Mini-Com [®] Modules.	Section B
D.	JBX3510 = Single Gang Two-Piece Snap Together Box.	K.25

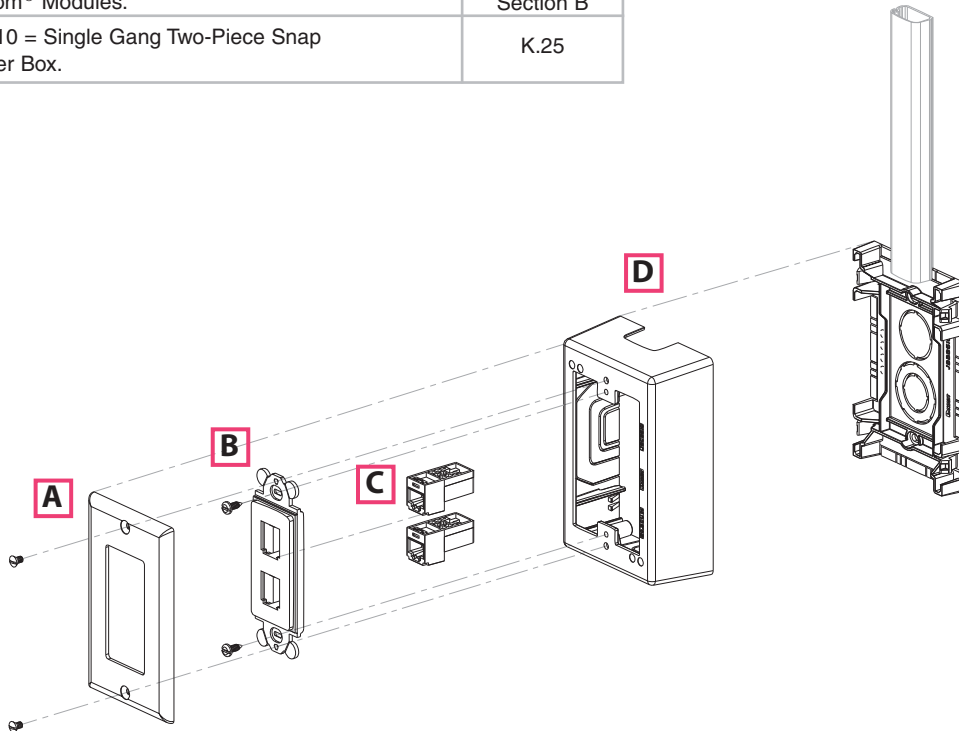

LD Configurations (continued)

Exploded View 2

	Components Required	See page
A.	UIT70FV2 = Ultimate ID [®] Sloped Vertical Snap-On Faceplate – 2-Port.	K.22
B.	Mini-Com [®] Modules.	Section B
C.	JBP2FS = Fast-Snap [™] Double Gang Power Rated Surface Mount Outlet Box.	K.26

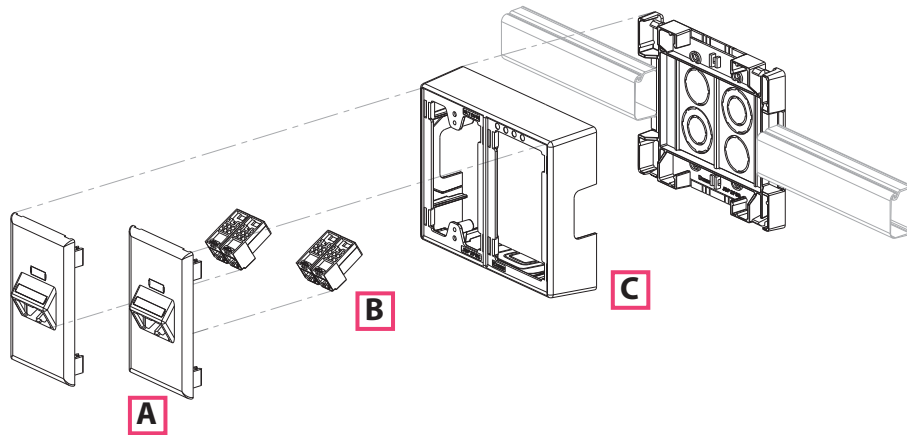

A.
System
Overview

B.
Copper
Systems

C.
Fiber
Optic
Systems

D.
Power
over
Ethernet

E.
Zone
Cabling

F.
Wireless

G.
Outlets

H.
Media
Distribution

I.
Physical
Infrastructure
Management

J.
Overhead &
Underfloor
Routing

K.
Surface
Raceway

L.
Cabinets,
Racks &
Cable
Management

M.
Grounding &
Bonding

N.
Industrial

O.
Labeling &
Identification

P.
Cable
Management
Accessories

Q.
Index

Pan-Way[®] LD Surface Raceway System

- For routing data and low voltage cabling
- One-piece hinged design allows cables to be laid in
- Factory applied adhesive backing speeds installation
- FT4 rated
- Terminates using surface mount outlet box solutions or Panduit[®] Mini-Com[®] Surface Mount Boxes

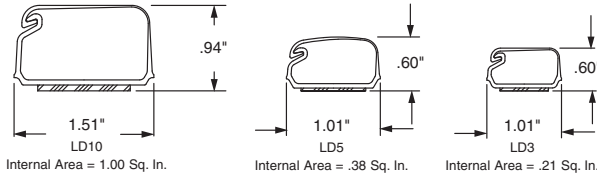

LD3



LD5



LD10

Part Number	Part Description	Raceway Size	Color [‡]	Length (Ft.)	Std. Ctn. Qty.
LD3 – Surface Raceway					
LD3IW6-A	One-piece latching surface raceway. Supplied with pre-applied adhesive backed tape. Available in 6', 8', and 10' lengths.	.77" x .46" (20.0mm x 12.0mm)	Off White	6	120
LD3IW8-A				8	160
LD3IW10-A				10	200
LD5 – Surface Raceway					
LD5IW6-A	One-piece latching surface raceway. Supplied with pre-applied adhesive backed tape. Available in 6', 8', and 10' lengths.	1.01" x .58" (26.0mm x 15.0mm)	Off White	6	120
LD5IW8-A				8	160
LD5IW10-A				10	200
LD10 – Surface Raceway					
LD10IW6-A	One-piece latching surface raceway. Supplied with pre-applied adhesive backed tape. Available in 6', 8', and 10' lengths.	1.51" x .94" (38.4mm x 24.0mm)	Off White	6	120
LD10IW8-A				8	160
LD10IW10-A				10	200

[‡]For other colors replace IW (Off White) with EI (Electric Ivory), IG (International Gray), or WH (White). Order number of feet required in multiples of standard length increments.

Standard Fittings for Low Voltage Applications

Image	Part Number	Part Description	Color‡	Std. Pkg. Qty.
 CF	CF3IW-E	Coupler fitting for use with LD3 raceway.	Off White	20
 RAF	CF5IW-E	Coupler fitting for use with LD5 raceway.	Off White	20
	CF10IW-X	Coupler fitting for use with LD10 raceway.	Off White	10
 ICF	RAF3IW-E	Right angle fitting for use with LD3 raceway.	Off White	20
 OCF	RAF5IW-E	Right angle fitting for use with LD5 raceway.	Off White	20
	RAF10IW-X	Right angle fitting for use with LD10 raceway.	Off White	10
 TF	ICF3IW-E	Inside corner fitting for use with LD3 raceway.	Off White	20
 ECF	ICF5IW-E	Inside corner fitting for use with LD5 raceway.	Off White	20
	ICF10IW-X	Inside corner fitting for use with LD10 raceway.	Off White	10
 CRFC	OCF3IW-E	Outside corner fitting for use with LD3 raceway.	Off White	20
 DCF	OCF5IW-E	Outside corner fitting for use with LD5 raceway.	Off White	20
	OCF10IW-X	Outside corner fitting for use with LD10 raceway.	Off White	10
 FBA	TF3IW-E	Tee fitting for use with LD3 raceway.	Off White	20
 RF	TF5IW-E	Tee fitting for use with LD5 raceway.	Off White	20
	TF10IW-X	Tee fitting for use with LD10 raceway.	Off White	10
	ECF3IW-E	End cap fitting for use with LD3 raceway.	Off White	20
	ECF5IW-E	End cap fitting for use with LD5 raceway.	Off White	20
	ECF10IW-X	End cap fitting for use with LD10 raceway.	Off White	10
	CRFC5IW-X	Four way cross fitting for use with LD5, LDPH5, and LDS5 raceway.	Off White	10
	DCF3IW-X	Drop ceiling/entrance end fitting for use with LD3 raceway.	Off White	10
	DCF5IW-X	Drop ceiling/entrance end fitting for use with LD5 raceway.	Off White	10
	DCF10IW-X	Drop ceiling/entrance end fitting for use with LD10 raceway.	Off White	10
	FBA5IW-X	Fire box adapter for use with LD5/LDPH5 profile raceway. NOTE: For low voltage applications only.	Off White	10
	FBA10IW-X	Fire box adapter for use with LD10/LDPH10 profile raceway. NOTE: For low voltage applications only.	Off White	10
	RF5X3IW-E	Reducer fitting for LD raceway from size 5 to size 3. For use with LD5 and LD3 raceway. For in-line terminations, use with CF5**.	Off White	20
	RF10X3IW-X	Reducer fitting for LD raceway from size 10 to size 3. For use with LD3 and LD10 raceway. For in-line terminations, use with CF10**.	Off White	10
	RF10X5IW-X	Reducer fitting for LD raceway from size 10 to size 5. For use with LD5 and LD10 raceway. For in-line terminations, use with CF10**.	Off White	10

‡For other colors replace IW (Off White) with EI (Electric Ivory), IG (International Gray), or WH (White).



One Inch Bend Radius Fittings for TIA/EIA Compliance

- One inch bend radius fittings are designed to maintain the TIA/EIA-568-B and 569-B required minimum bend radius for high performance copper and fiber optic cabling systems

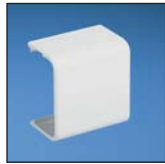

CFX

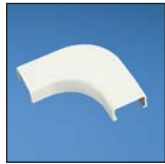

RAFC

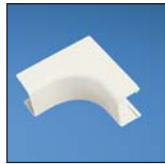

ICFC



OCFX



TFC



CRFC5

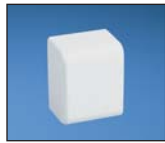

ECFX

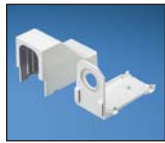

DCEFX



RAEFX



RFX

Part Number	Part Description	Color‡	Std. Pkg. Qty.
CFX3IW-X	Coupler fitting for use with LD3, LDPH3, and LDS3 raceway.	Off White	10
CFX5IW-X	Coupler fitting for use with LD5, LDPH5, and LDS5 raceway.	Off White	10
CFX10IW-X	Coupler fitting for use with LD10, LDPH10, and LD2P10 raceway.	Off White	10
RAFC3IW-X	Right angle fitting for use with LD3, LDPH3, and LDS3 raceway.	Off White	10
RAFC5IW-X	Right angle fitting for use with LD5, LDPH5, and LDS5 raceway.	Off White	10
RAFC10IW-X	Right angle fitting for use with LD10 and LDPH10 raceway.	Off White	10
ICFC3IW-X	Inside corner fitting for use with LD3, LDPH3, and LDS3 raceway.	Off White	10
ICFC5IW-X	Inside corner fitting for use with LD5, LDPH5, and LDS5 raceway.	Off White	10
ICFC10IW-X	Inside corner fitting for use with LD10 and LDPH10 raceway.	Off White	10
OCFX3IW-X	Outside corner fitting for use with LDPH3 and LDS3 raceway.	Off White	10
OCFX5IW-X	Outside corner fitting for use with LDPH5 and LDS5 raceway.	Off White	10
OCFX10IW-X	Outside corner fitting for use with LDPH10 and LD2P10 raceway.	Off White	10
TFC3IW-X	Tee fitting for use with LD3, LDPH3, and LDS3 raceway.	Off White	10
TFC5IW-X	Tee fitting for use with LD5, LDPH5, and LDS5 raceway.	Off White	10
TFC10IW-X	Tee fitting for use with LD10 and LDPH10 raceway.	Off White	10
CRFC5IW-X	Four way cross fitting for use with LD5, LDPH5, and LDS5 raceway.	Off White	10
ECFX3IW-X	End cap fitting for use with LDPH3 and LDS3 raceway.	Off White	10
ECFX5IW-X	End cap fitting for use with LDPH5 and LDS5 raceway.	Off White	10
ECFX10IW-X	End cap fitting for use with LDPH10 and LD2P10 raceway.	Off White	10
DCEFXIW-X	Drop ceiling/entrance end fitting for use with LD3, LDPH3, LDS3, LD5, LDPH5, LDS5, LD10 and LDPH10 raceway. Use CA3 or CA5 adapters for LD3 or LD5 profile raceway.	Off White	10
RAEFXIW-X	Right angle/entrance end fitting for use with LD3, LDPH3, LDS3, LD5, LDPH5, LDS5, LD10 and LDPH10 raceway. CA3 or CA5 adapters for LD3 or LD5 profile raceway.	Off White	10
RFX53IW-X	Reducer fitting for use with LD3, LDPH3, LDS3, LD5, LDPH5 and LDS5 raceway. For in-line terminations, use with CFX5**.	Off White	10
RFX103IW-X	Reducer fitting for use with LD3, LDPH3, LD10 and LDPH10 raceway. For in-line terminations, use with CFX10**.	Off White	10
RFX105IW-X	Reducer fitting for use with LD5, LDPH5, LDS5, LD10 and LDPH10 raceway. For in-line terminations, use with CFX10**.	Off White	10

‡For other colors replace IW (Off White) with EI (Electric Ivory), IG (International Gray), or WH (White).

Cable Fill Capacities for LD Raceway

This information is to be used as a guide in selecting the proper size raceway. The maximum amounts may vary according to the cable installation methods, straightness of cables, etc.



LD3	LD5	LD10
.21 in. ²	.38 in. ²	1.00 in. ²

SPEC = 40% cable fill – The recommended design in cable capacity, leaves room for future moves, adds, and changes.

MAX for Data = 60% cable fill – The maximum cable quantity based on cable interweaving and packing factors.

Raceway Type & Configuration	Fill Area (in ²)	Electrical Cables			Data Grade Cables 24 AWG/UTP CM								Audio/Video		Fiber Optic Cable	
		14 AWG	12 AWG	10 AWG	Cat 5e – Plenum		Cat. 6		Cat. 6A		Cat. 6A (SD)		RG6		2 Strand	
		0.111	0.130	0.164	DIA. = 0.193		DIA. = 0.24		DIA. = 0.30		DIA. = 0.24		DIA. = 0.275		DIA. = 0.175	
		FILL			FILL		FILL		FILL		FILL		FILL		FILL	
		MAX	MAX	MAX	SPEC	MAX	SPEC	MAX	SPEC	MAX	SPEC	MAX	SPEC	MAX	SPEC	MAX
		(UL Temp Rise Test)			40%	60%	40%	60%	40%	60%	40%	60%	40%	60%	40%	60%
LD3	0.21	**	**	**	2	4	1	2	1	1	1	2	1	2	3	5
LD5	0.38	**	**	**	5	7	3	5	2	3	3	5	2	3	6	9
LD10	1.00	**	**	**	13	20	8	13	5	8	8	13	6	10	16	24

AWG dimensions represent typical outer cable diameter in inches.

* = .298 diameter cable can be used for riser applications.



Panduit® Mini-Com® Ultimate ID® Sloped Snap-On Faceplates

- For use with Panduit raceway: LD, T-45, T-70, Twin-70, TG-70, Pan-Pole™ Outlet Pole and Fast-Snap™ Outlet Boxes
- Snap into raceway channel or outlet box and requires no additional mounting hardware or adapters – greatly reducing installation time
- Meet stringent UL5A standard for non-metallic raceways
- Accept Mini-Com® Modules for STP and UTP fiber optic and coax, which snap in and out for easy moves, adds, and changes
- Can be clearly identified with the PanTher™ LS8E or the Cougar™ LS9 Hand-Held Thermal Transfer Printers
- Computer printable label sheets for desktop printers and write-on labels available
- Supplied with clear station and port label covers, labels sold separately
- Replacement label covers available
- Optional icons available
- Ultimate ID® components are part of a complete system for identification designed to efficiently support TIA/EIA-606-A standard labeling requirements



UIT70FH2



UIT70FH4



UIT70FV2



UIT70FV4

Part Number	Part Description	Labels Required*	Color‡	Std. Pkg. Qty.	Std. Ctn. Qty.
UIT70FH2IW	Single gang, horizontal sloped communication snap-on faceplate accepts up to two Mini-Com® Modules.	One 1-Port One 2-Port	Off White	1	10
UIT70FH4IW	Single gang, horizontal sloped communication snap-on faceplate accepts up to four Mini-Com® Modules.	One 1-Port One 4-Port	Off White	1	10
UIT70FV2IW	Single gang, vertical sloped communication snap-on faceplate accepts up to two Mini-Com® Modules.	One 1-Port One 2-Port	Off White	1	10
UIT70FV4IW	Single gang, vertical sloped communication snap-on faceplate accepts up to four Mini-Com® Modules.	One 1-Port Two 2-Port	Off White	1	10

‡For other colors replace suffix IW (Off White) with EI (Electric Ivory), WH (White), or IG (International Gray).

Component Labels for Mini-Com® Ultimate ID® Sloped Snap-On Faceplates for Use with Panduit® Mini-Com® Modules



Suggested Label Solutions for TIA/EIA-606-A Compliance				
Faceplate Part Number	Laser/Ink Jet Desktop Printer Label	TDP43ME Thermal Transfer Desktop Printer Label	PanTher™ LS8E Hand-Held Printer Label	Cougar™ LS9 Hand-Held Printer Label
UIT70FH2IW	UILJ2	—	UILS8BW	UILS8BW
UIT70FH4IW	UILJ4			
UIT70FV2IW	UILJ2			
UIT70FV4IW	UILJ4			



Pan-Way® Classic Series Snap-On Faceplates for Use With Panduit® Mini-Com® Modules

- Can be used with Pan-Way® Cove, TG-70, T-70, Twin-70, T-45 Raceway Systems, Fast-Snap™ Outlet Boxes and Pan-Pole™ Aluminum Outlet Pole

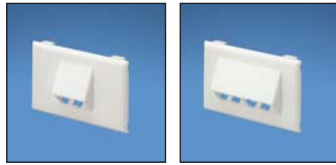

T70FH2

T70FH4



T70FV2

T70FV4

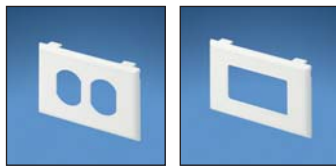

T70P

T70PG

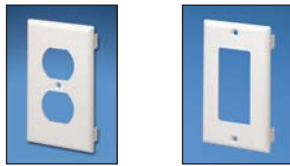

T70PS

T70PGS

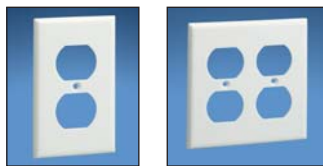

CP106

CP106**-2G

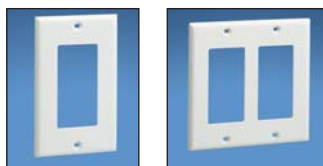

CPG

CPG**-2G

Part Number	Part Description	Color‡	Std. Pkg. Qty.	Std. Ctn. Qty.
T70FH2IW	Snap-on horizontal sloped communication faceplate. Accepts two Panduit® Mini-Com® Modules (not included). No additional mounting hardware required.	Off White	1	10
T70FH4IW	Snap-on horizontal sloped communication faceplate. Accepts four Panduit® Mini-Com® Modules (not included). No additional mounting hardware required.	Off White	1	10
T70FV2IW	Snap-on vertical sloped communication faceplate. Accepts two Panduit® Mini-Com® Modules (not included). No additional mounting hardware required.	Off White	1	10
T70FV4IW	Snap-on vertical sloped communication faceplate. Accepts four Panduit® Mini-Com® Modules (not included). No additional mounting hardware required.	Off White	1	10
T70PIW	Snap-on single gang 106 duplex electrical/communication faceplate. Used to cover one NEMA standard 106 duplex electrical outlet. In communication applications, covers one standard 106 duplex communication module frame.	Off White	1	10
T70PGIW	Snap-on single gang rectangular electrical/communication faceplate. Used to cover one NEMA standard rectangular electrical outlet. In communication applications, covers one standard rectangular communication module frame.	Off White	1	10
T70PSIW	Snap-on single gang 106 duplex communication faceplate. Used to cover one NEMA standard 106 duplex communication module frame. Module frame screw mounts directly to underside of snap-on faceplate. No mounting device needed. Supplied with one mounting screw. NOTE: Not for use with electrical devices.	Off White	1	10
T70PGSIW	Snap-on single gang rectangular communication faceplate. Used to cover one NEMA standard rectangular communication module frame. Module frame screw mounts directly to underside of snap-on faceplate. No mounting device needed. NOTE: Not for use with electrical devices.	Off White	1	10
CP106IW	Screw-on single gang 106 duplex faceplate. Covers one NEMA standard 106 duplex electrical outlet or one standard 106 communication module frame.	Off White	1	10
CP106IW-2G	Screw-on double gang 106 duplex faceplate. Covers two NEMA standard 106 duplex electrical outlets or two standard 106 communication module frames.	Off White	1	10
CPGIW	Screw-on single gang rectangular faceplate. Covers one NEMA standard rectangular electrical outlet or one standard rectangular communication module frame.	Off White	1	10
CPGIW-2G	Screw-on double gang rectangular faceplate. Covers two NEMA standard rectangular electrical outlets or two standard rectangular communication module frames.	Off White	1	10

‡For other colors replace IW (Off White) with EI (Electric Ivory), IG (International Gray), or WH (White).

Component Labels for Pan-Way[®] Classic Series Snap-On Faceplates for Use with Panduit[®] Mini-Com[®] Modules











Suggested Label Solutions for TIA/EIA-606-A Compliance

Faceplate Part Number	Laser/Ink Jet Desktop Printer Label	TDP43ME Thermal Transfer Desktop Printer Label	PanTher™ LS8E Hand-Held Printer Label	Cougar™ LS9 Hand-Held Printer Label
T70FH2IW	C125X030FJJ	C125X030YPT	C125X030FJC	T031X000FJC-BK
T70FV2IW				
T70FV4IW				
T70FH4IW	C252X030FJJ	C252X030YPT	C252X030FJC	T031X000FJC-BK
CP106IW	C061X030FJJ	C061X030YPT	C061X030FJC	T031X000FJC-BK
CP106IW-2G	2 - C061X030FJJ	2 - C061X030YPT	2 - C061X030FJC	T031X000FJC-BK
CPGIW	C125X030FJJ	C125X030YPT	C125X030FJC	T031X000FJC-BK
T70PGSIW				
CPGIW-2G	2 - C125X030FJJ	2 - C125X030YPT	2 - C125X030FJC	T031X000FJC-BK
T70PGIW	C261X030FJJ	T031X000FJT	C261X030FJC	T031X000FJC-BK
T70PIW				
T70PSIW				



Pan-Way® Low Voltage Surface Mount Outlet Boxes

- JBX3510 assembles without the use of screws for faster installation
- JBX3510, JB1, JB1FS, JBP2FS, and JB1D are supplied with adhesive backing to speed installation
- JB1 and JB1D are a one-piece design requiring no assembly

Part Number	Part Description	Color‡	Std. Pkg. Qty.	Std. Ctn. Qty.
  JBX3510 JB1	JBX3510IW-A Single gang two-piece snap together outlet box with adhesive backing. Box accepts Pan-Way® Screw-On Faceplates or any NEMA standard single gang faceplate. For use with Pan-Way® T45 or LD profile raceway. 5.00"L x 3.26"W x 1.62"H (127.1mm x 82.7mm x 41.1mm). Breakouts for 1/2", 3/4", or 1" diameter conduit.	International White	1	10
  JB1D JBP2	JB1IW-A Single gang one-piece outlet box with adhesive backing. Box accepts Pan-Way® Screw-On Faceplates or any NEMA standard single gang faceplate. For use with Pan-Way® LD profile raceway. 5.09"L x 3.34"W x 1.75"H (129.4mm x 85.0mm x 44.4mm). Breakouts for 1/2", 3/4", or 1" diameter conduit.	International White	1	10
  JBP2D JBP3D	JB1DIW-A Single gang one-piece deep outlet box with adhesive backing. Box accepts Pan-Way® Screw-On Faceplates or any NEMA standard single gang faceplate. For use with Pan-Way® LD profile raceway. 5.23"L x 3.48"W x 2.75"H (133.0mm x 88.5mm x 69.8mm). Breakouts for 1/2", 3/4", or 1" diameter conduit.	International White	1	10
  RJBX3510 JBA-X	JBP2IW Double gang two-piece screw together outlet box. Box accepts Pan-Way® Screw-On Faceplates or any NEMA standard double gang faceplates. For use with Pan-Way® LD profile raceway. 5.05"L x 5.05"W x 1.62"H (128.2mm x 128.2mm x 41.1mm). Breakouts for 1/2" or 3/4" diameter conduit.	International White	1	10
	JBP2DIW Double gang two-piece screw together deep outlet box. Box accepts Pan-Way® Screw-On Faceplates or any NEMA standard double gang faceplate. For use with Pan-Way® T-45 or LD profile raceway. 5.19"L x 5.19"W x 2.75"H (131.9mm x 131.9mm x 69.8mm). Breakouts for 1/2", 3/4", or 1" diameter conduit.	International White	1	10
	JBP3DIW Three gang, two-piece screw together deep outlet box. Box accepts Pan-Way® Screw-On Faceplates or any NEMA standard three gang faceplates. For use with Pan-Way® LD, LDPH or T-45 surface raceway systems. 7.00"L x 5.19"W x 2.75"H (177.9mm x 131.9mm x 69.8mm). Breakouts for 1/2", 3/4" and 1" diameter conduit.	International White	1	10
	RJBX3510IW Single gang two-piece screw together round outlet box. Box accepts UL/CSA devices not to exceed 10lbs. (5lbs. per CSA). For use with Pan-Way® LD profile raceway. Dia. = 5.48"D x 1.14"H (139.2mm x 29.0mm). Breakouts for 3/4" or 1" diameter conduit.	International White	1	5
	JBA-X In-wall box adapter. Adapts single gang surface mount outlet boxes to in-wall conduit boxes.	—	10	100

‡For other colors replace IW (International White) with EI (Electric Ivory), IG (International Gray), or WH (White).

**Pan-Way[®] Low Voltage Surface Mount Outlet Boxes (continued)****JB1FS****JB1FSD****JBP1FS****JBP2FS**

Part Number	Part Description	Color‡	Std. Pkg. Qty.	Std. Ctn. Qty.
JB1FSIW-A	Single gang two-piece snap together outlet box with adhesive backing. Box accepts Pan-Way [®] Snap-On Faceplates. For use with Pan-Way [®] T-45 or LD profile raceway. 5.00"L x 3.26"W x 1.62"H (127.1mm x 82.7mm x 41.1mm). Breakouts for 1/2", 3/4", or 1" diameter conduit.	International White	1	10
JB1FSDIW-A	Fast-Snap™ Single Gang Two-Piece Snap Together Deep Outlet Box with adhesive backing. Box accepts Pan-Way [®] Snap-On Faceplates. For use with Pan-Way [®] T-45 or LD profile raceway. 5.16"L x 3.41"W x 2.75"H (131.1mm x 86.7mm x 69.8mm). Breakouts for 1/2", 3/4", or 1" diameter conduit.	International White	1	10
JBP1FSIW	Single gang power rated two-piece snap together outlet box. Box accepts Pan-Way [®] Snap-On Faceplates. For use with Pan-Way [®] T-45 or LD, LDP, LDPH, LDS profile raceways. 5.00"L x 3.26"W x 1.62"H (127.1mm x 82.7mm x 41.1mm). Breakouts for 1/2", 3/4", or 1" diameter conduit.	Off White	1	10
JBP2FSIW	Double gang power rated two-piece snap together outlet box. Box accepts Pan-Way [®] Snap-On Faceplates. For use with Pan-Way [®] T-45 or LD profile raceway. 5.00"L x 6.14"W x 1.62"H (127.1mm x 155.9mm x 41.1mm). Breakouts for 1/2", 3/4", or 1" diameter conduit.	International White	1	10

‡For other colors replace IW (International White) with EI (Electric Ivory), IG (International Gray), or WH (White).

PRE-CONFIGURED PHYSICAL INFRASTRUCTURES, CABINETS, RACKS, AND CABLE MANAGEMENT SOLUTIONS

Panduit provides leading edge pre-configured physical infrastructures, cabinets, racks, and cable management solutions for telecommunications equipment rooms, data centers, and premise wiring applications. As the demand for system performance increases, it becomes essential to protect and manage cables to maintain system reliability and scalability. Panduit continues to provide innovative products that create end-to-end solutions for managing, protecting, and showcasing your network for the lowest cost of ownership.



- Panduit Pre-Configured Physical Infrastructures for Cisco[^] UCS, Nexus 7010, Catalyst 6509 and Nexus 7009 platforms increase business agility through high-performance, flexible, scalable and reliable data center design.
- Net-Access[™] Switch and Server Cabinets have been optimized for higher density switch and server applications. Superior cable management, inset frame, and in-cabinet ducting options ensure proper airflow for improved network performance and availability
- Net-SERV[®] Cabinets are designed to provide the best combination of space utilization and thermal management for server applications. Net-SERV[®] Cabinets are designed to complement the Net-Access[™] Cabinets and provide a complete, optimized physical infrastructure solution for all switch and server architectures
- Panduit rack systems allow complete flexibility for a wide range of cable and equipment combinations and are designed to maximize cable access
- Vertical cable managers allow increased cable density for maximum space utilization and organization
- Panduit[®] NetManager[™] High Capacity Horizontal Cable Managers provide an efficient way to manage high performance copper, fiber, or coaxial cables
- CoolBoot[™] Raised Floor Air Sealing Grommet redirects a greater amount of conditioned air toward cooling network equipment, thus minimizing the risk associated with overheating
- Panduit cable management products and accessories maintain bend radius control and cable performance while bundling and securing cable to prevent snags and stress from overbending

[^]Cisco is a registered trademark of Cisco Technology Inc.



Panduit Pre-Configured Physical Infrastructures for Cisco[^] UCS, Nexus, and Catalyst Platforms

Optimized for Power, Cooling, and Performance

As a leading physical infrastructure partner for Cisco, Panduit works with Cisco engineering and product teams to develop optimal physical layer solutions for their networking products. As such, these Panduit Pre-Configured Physical Infrastructures were designed specifically for the Cisco[^] UCS, Nexus, and Catalyst platforms to balance scalability, power and thermal characteristics. This approach ensures that the physical infrastructure deployments are optimized for power, cooling, and performance, lowering infrastructure risks and costs while increasing agility and sustainability.

Scalability

Panduit Pre-Configured Physical Infrastructures for Cisco[^] UCS, Nexus, and Catalyst platforms are designed to support various line card and equipment densities, thus enabling business growth and agility across the entire offering. Panduit Pre-Configured Physical Infrastructures also accommodate migration from 10G to 40G/100G Ethernet with minimum investment and downtime. Making changes to a Cisco[^] UCS, Nexus, or Catalyst platform deployment is easy, with modular QuickNet™ Patch Panels and connectivity enabling quick migration to higher speeds.

Optimized Power and Thermal Management

Equipment configurations ensure even power usage within an individual cabinet and across multiple cabinets, minimizing hot spots that can impact system performance and reliability. Panduit Power Outlet Units (POUs) are available separately to provide optimal capacity and redundancy across all Cisco[^] UCS, Nexus, and Catalyst platforms. Panduit Pre-Configured Physical Infrastructures for Cisco[^] UCS, Nexus, and Catalyst platforms conserve energy by establishing front-to-back airflow patterns and synergistic physical layouts to maximize power and thermal efficiencies.

Panduit Pre-Configured Physical Infrastructures for Cisco[^] UCS, Nexus, and Catalyst platforms offer high-density, optimum heat load data center designs for greater thermal efficiencies.

- Perforated cabinet doors and cabinet frame designs that maximize airflow area
- Optional Vertical Exhaust Systems (VES) that isolate and duct hot exhaust air to the hot air return plenum to improve hot/cold air separation, thus enabling cooling efficiency
- Vertical air dams and sealing features that minimize leak paths between hot and cold aisles, ensuring that valuable cooling goes through equipment
- Thermal load distributions within cabinets that maximize the availability of cooling airflow

When combined with additional Panduit passive, optimized thermal management solutions, Panduit Pre-Configured Physical Infrastructures for Cisco[^] UCS, Nexus, and Catalyst platforms can provide substantial reductions in the energy costs of a typical data center.

[^]Cisco is a registered trademark of Cisco Technology, Inc.

Panduit Pre-Configured Physical Infrastructure for Cisco^ Unified Computing Systems (UCS)

The Cisco^ Unified Computing System (UCS) is a next-generation data center platform that unites compute, network, storage access, and virtualization into a cohesive system. Panduit's Pre-Configured Physical Infrastructures support the deployment of up to five UCS Blade Server Chassis within various cabinet footprints that optimize the physical infrastructure for the UCS server architectures. Three different cabinet widths are offered including:

- 32-inch version with Net-Access™ Cabinet that provides maximum room for cable management, POUs and easy access to serviceable parts such as cards, fans and power supplies
- 28-inch version with Net-SERV® Cabinet for customers seeking a balance between floor space and cable management area
- 24-inch version with Net-SERV® Cabinet maximizes floor space utilization for traditional deployments on raised floors. The trade-off for the narrower width is the reduction in space for cable management, and accessibility to the serviceable items



(32" Cisco^ UCS Pre-Configured Physical Infrastructure shown in a Net-Access™ Cabinet)



SFP+ Cables are available as an option for Cisco UCS Deployments

Part Number	Part Description	Std. Pkg. Qty.
CQ5108CS1B	Pre-Configured Physical Infrastructure for UCS Base with 32" wide Net-Access™ Cabinet and all necessary cable management, grounding jumpers, and patch panels pre-assembled together.	1
CQ5108S752B	Pre-Configured Physical Infrastructure for UCS Base with 28" wide Net-SERV® Cabinet and all necessary cable management, grounding jumpers, and patch panels pre-assembled together.	1
CQ5108S652B	Pre-Configured Physical Infrastructure for UCS Base with 24" wide Net-SERV® Cabinet and all necessary cable management, grounding jumpers, and patch panels pre-assembled together.	1

Cisco^ UCS Blade Servers not included in the part numbers above. Panduit Pre-Configured Physical Infrastructures are shipped on standard pallets. For applications that require shock-resistant packaging to facilitate pre-mounting of active electronics, please consult Panduit Customer Service.

^Cisco is a registered trademark of Cisco Technology Inc.

Panduit Pre-Configured Physical Infrastructure for the Cisco[^] Nexus 7010 Switch

The Cisco[^] Nexus 7010 Switch enables data center stakeholders to deploy a highly scalable 10 Gigabit Ethernet (GbE) network that supports virtualization technologies for consolidation of multiple applications over a smaller number of more powerful servers and switches. Panduit's Pre-Configured Physical Infrastructures support the deployment of Cisco[^] Nexus 7010 platforms with pre-assembled configurations that are offered in versions that meet typical copper and fiber line card provisioning schemes including:

- "Medium Fiber" for switch provisions requiring up to (4) 32-port fiber line cards
- "Medium Copper" for switch provisions requiring up to (4) 48-port copper line cards
- "Heavy Copper" for switch provisions requiring up to (6) 48-port copper line cards



(Nexus 7010 "Heavy Copper"
Pre-Configured Physical
Infrastructure shown)

Part Number	Part Description	Std. Pkg. Qty.
CQ7010CN1B	"Base" Pre-Configured Physical Infrastructure for Cisco [^] Nexus 7010 with Net-Access [™] Cabinet, and all necessary cable management, grounding jumpers, and patch panels pre-assembled together.	1
CQ7010CN1F4	"Medium Fiber" Pre-Configured Physical Infrastructure for Cisco [^] Nexus 7010 with Net-Access [™] Cabinet, and all necessary cable management, grounding jumpers, patch panels, and LC-LC patch cords (bulk packaged to accommodate 4 additional fiber line cards) pre-assembled together.	1
CQ7010CN1C4	"Medium Copper" Pre-Configured Physical Infrastructure for Cisco [^] Nexus 7010 with Net-Access [™] Cabinet, and all necessary cable management, grounding jumpers, patch panels, and copper CAT6 patch cords (bulk packaged to accommodate 4 additional copper line cards) pre-assembled together.	1
CQ7010CN1C6	"Heavy Copper" Pre-Configured Physical Infrastructure for Cisco [^] Nexus 7010 with Net-Access [™] Cabinet, and all necessary cable management, grounding jumpers, patch panels, and CAT6 patch cords (bulk packaged to accommodate 6 additional copper line cards) pre-assembled together.	1

Cisco[^] Nexus 7010 Switch not included in the part numbers above. Panduit Pre-Configured Physical Infrastructures are shipped on standard pallets. For applications that require shock-resistant packaging to facilitate pre-mounting of active electronics, please consult Panduit Customer Service.

[^]Cisco is a registered trademark of Cisco Technology Inc.

Panduit Pre-Configured Physical Infrastructure for the Cisco^ Catalyst 6509 Switch

The Cisco^ Catalyst 6509 Switch provides high port densities that are ideal for many wiring closet, distribution, and core network deployments. Panduit's Pre-Configured Physical Infrastructures support the deployment of the Cisco^ Nexus 6509 switch with pre-assembled configurations that are offered in versions that meet 10 GbE density copper and fiber line card provisioning schemes, including:

- "Medium Fiber" for switch provisions requiring up to (4) 32-port fiber line cards
- "Medium Copper" for switch provisions requiring up to (4) 48-port copper line cards
- "Heavy Copper" for switch provisions requiring up to (6) 48-port copper line cards



(Catalyst 6509 "Heavy Copper" Pre-Configured Physical Infrastructure shown)

Part Number	Part Description	Std. Pkg. Qty.
CQ6509CN1B	"Base" Pre-Configured Physical Infrastructure for Cisco^ Catalyst 6509 with Net-Access™ Cabinet, and all necessary cable management, grounding jumpers, and patch panels pre-assembled together.	1
CQ6509CN1F4	"Medium Fiber" Pre-Configured Physical Infrastructure for Cisco^ Catalyst 6509 with Net-Access™ Cabinet, and all necessary cable management, grounding jumpers, patch panels, and LC-LC patch cords (bulk packaged to accommodate 4 additional fiber line cards) pre-assembled together.	1
CQ6509CN1C4	"Medium Copper" Pre-Configured Physical Infrastructure for Cisco^ Catalyst 6509 with Net-Access™ Cabinet, and all necessary cable management, grounding jumpers, patch panels, and copper CAT6 patch cords (bulk packaged to accommodate 4 additional copper line cards) pre-assembled together.	1
CQ6509CN1C6	"Heavy Copper" Pre-Configured Physical Infrastructure for Cisco^ Catalyst 6509 with Net-Access™ Cabinet, and all necessary cable management, grounding jumpers, patch panels, and CAT6 patch cords (bulk packaged to accommodate 6 additional copper line cards) pre-assembled together.	1

Cisco^ Catalyst 6509 Switch not included in the part numbers above. Panduit Pre-Configured Physical Infrastructures are shipped on standard pallets. For applications that require shock-resistant packaging to facilitate pre-mounting of active electronics, please consult Panduit Customer Service.

^Cisco is a registered trademark of Cisco Technology Inc.

Panduit Pre-Configured Physical Infrastructure for the Cisco[^] Nexus 7009 Switch



(Nexus 7009 "Heavy Copper"
Pre-Configured Physical
Infrastructure shown)

The Cisco[^] Nexus 7009 Switch enables data center stakeholders to deploy a highly scalable 10 Gigabit Ethernet (GbE) network that supports virtualization technologies for consolidation of multiple applications over a smaller number of more powerful servers and switches. All cabinet versions of Panduit pre-configured offerings for the Nexus 7009 include newly designed intake duct to optimize cooling airflow.

Panduit Pre-Configured Physical Infrastructures support the deployment of Cisco[^] Nexus 7009 Switch platforms with pre-assembled configurations that are offered in versions that meet typical copper and fiber line card provisioning schemes including:

- "Medium Fiber" for switch provisions requiring up to (4) 32-port fiber I/O Modules
- "Medium Copper" for switch provisions requiring up to (4) 48-port copper I/O Modules
- "Heavy Copper" for switch provisions requiring up to (6) 48-port copper I/O Modules

Item	Part Description	Std. Pkg. Qty.
CQ7009CN01	"Base" Pre-Configured Physical Infrastructure for Cisco [^] Nexus 7009 with Net-Access™ Cabinet and intake ducting, as well as all necessary cable management, grounding jumpers, and patch panels.	1
CQ7009CN02	"Medium Fiber" Pre-Configured Physical Infrastructure for Cisco [^] Nexus 7009 with Net-Access™ Cabinet and intake ducting, as well as all necessary cable management, grounding jumpers, patch panels, and MTP-LC Hydra cable assemblies (bulk packaged to accommodate four fiber I/O Modules).	1
CQ7009CN03	"Medium Copper" Pre-Configured Physical Infrastructure for Cisco [^] Nexus 7009 with Net-Access™ Cabinet and intake ducting, as well as all necessary cable management, grounding jumpers, patch panels, and copper Category 6A patch cords (bulk packaged to accommodate four copper I/O Modules).	1
CQ7009CN04	"Heavy Copper" Pre-Configured Physical Infrastructure for Cisco [^] Nexus 7009 with Net-Access™ Cabinet and intake ducting, as well as all necessary cable management, grounding jumpers, patch panels, and copper Category 6A patch cords (bulk packaged to accommodate six copper I/O Modules).	1

Cisco[^] Nexus 7009 Switch not included in the part numbers above. Panduit Pre-Configured Physical Infrastructures are shipped on standard pallets. For applications that require shock-resistant packaging to facilitate pre-mounting of active electronics, please consult Panduit Customer Service.

[^]Cisco is a registered trademark of Cisco Technology Inc.



Net-Access™ Cabinet System

Thermal Management and Cable Capacity for Switch and Server Applications

Net-Access™ Cabinets are the first choice for switch, server, and storage area network applications that require maximum thermal management capability, and the capacity to manage high cable densities.

Net-Access™ Switch Cabinet features include:

- In-cabinet ducting solutions to enable optimized airflow of switches with side-to-side airflow
- Large vertical pathways for high cable count applications
- Cable management fingers mount to front and back posts for maximum cabling configurations
- Dual hinge door for maximum accessibility between adjacent cabinets

Net-Access™ Server Cabinet features and options include:

- Vertical exhaust duct for optimal thermal performance
- Provides maximum cable management area and thermal performance
- Vertical patch panel configuration provides up to eight additional rack units in the same footprint
- Utilizes same platform as switch cabinet to enable maximum flexibility and deployment options



Net-Access™ Switch Cabinets are compatible with Cisco^ Nexus 7018, MDS9500 Series, and 6500 Series Switches. Go to www.panduit.com/cisco1 for disclaimer.

Nexus 7018 and 7010 Applications are supported by Application Guides/Notes available at panduit.com.

^Cisco is a registered trademark of Cisco Technology, Inc.



A.
System
Overview

B.
Copper
Systems

C.
Fiber
Optic
Systems

D.
Power
over
Ethernet

E.
Zone
Cabling

F.
Wireless

G.
Outlets

H.
Media
Distribution

I.
Physical
Infrastructure
Management

J.
Overhead &
Underfloor
Routing

K.
Surface
Raceway

L.
Cabinets,
Racks &
Cable
Management

M.
Grounding &
Bonding

N.
Industrial

O.
Labeling &
Identification

P.
Cable
Management
Accessories

Q.
Index

Net-Access™ Cabinet Applications



UCS
Server

Nexus
7018

Nexus
7010

MDS
9513

Catalyst
6509



Net-Access™ Switch Cabinets are compatible with Cisco^ Nexus 7018, MDS9500 Series, and 6500 Series Switches. Go to www.panduit.com/cisco1 for disclaimer.

Nexus 7018 and 7010 Applications are supported by Application Guides/Notes available at panduit.com.

^Cisco is a registered trademark of Cisco Technology, Inc.

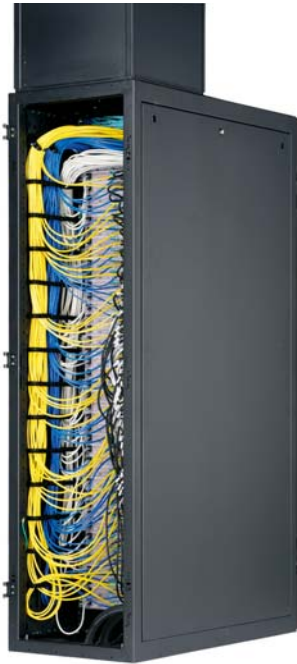

Net-SERV® Cabinet System

Optimized Thermal and Cable Management for Server Applications

Net-SERV® Cabinets provide thermal and cable management to accommodate low to high-density server deployments. Vertical exhaust ducting can be used to optimize airflow, reducing energy costs by up to 25%. Air sealing accessories prevent leaks and improve the utilization of cooling air.

High Density Server Configuration:

- 600mm (24") or 700mm (28") widths
- High density solution provides four separate vertical pathways and modular L-rings with bend radius control for optimum cable routing
- Organizes data and power cables in segregated channels away from server exhaust for unobstructed airflow
- Vertical exhaust duct configuration available

Vertical Patch Cable Management Configuration:

- 700mm (28") width
- Vertical patch panel solution provides up to four additional rack units in the same footprint
- Maximizes rack space utilization for additional servers and other devices
- Positions network connections in the optimum location allowing the use of single length patch cords
- Supplied with cable management fingers at each rack unit to manage data and power cables



Standard Density Server Configuration:

- 600mm (24") or 700mm (28") widths
- Provides cable management fingers at each rack unit to manage data and power cables

Net-Access™ Switch Cabinets Roadmap

Manages, protects, and showcases your network by combining the aesthetics and security of a cabinet with the accessibility of an open rack

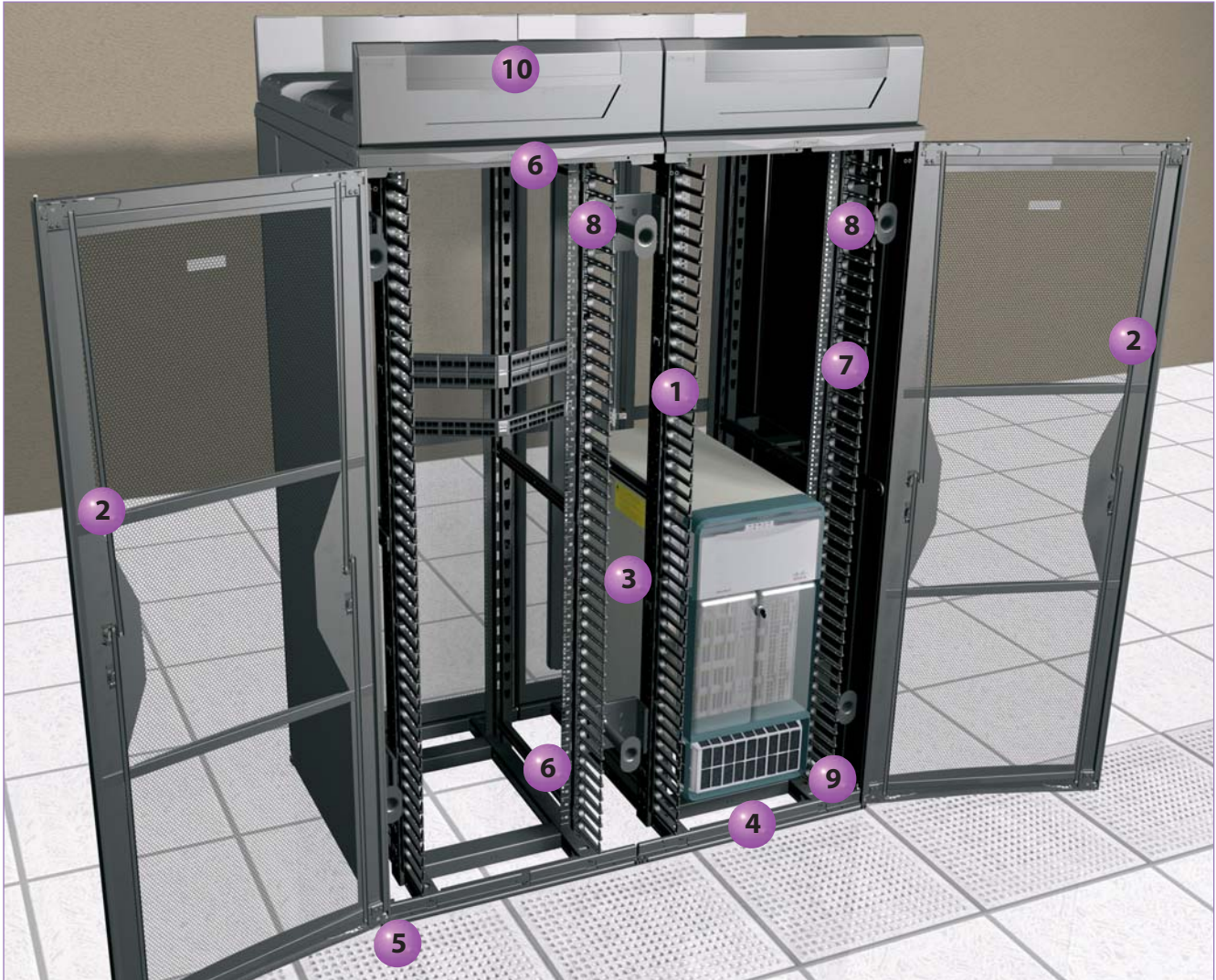

Net-Access™ Switch Cabinets have tested compatible with Cisco Nexus 7018, MDS 9513, and Catalyst 6509. Go to www.panduit.com/cisco1 for disclaimer.

Net-Access™ Switch Cabinets Roadmap (continued)

1 Cable Management – Vertical cable pathway design is optimized to provide unobstructed access; cable management finger sections can be located where needed on all four posts and align with rack spaces to ensure proper bend radius control



6 Routing Options for Overhead and Underfloor Cabling – Knockouts in the top allow multiple options for overhead cable routing; large bottom openings provide pathways for routing cables from underfloor

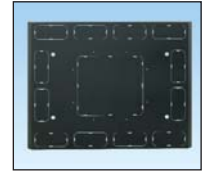

2 Dual Hinged Door – Door can be opened 180° to left or right enabling unobstructed access to adjacent cabinets and pathways



7 Adjustable Equipment Rails – Front and rear rails are fully adjustable to accommodate a variety of equipment and have printed rack space identification

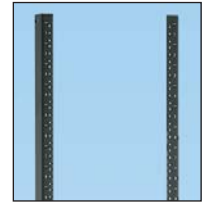

3 Thermal Management – Inset frame posts and cable management ensure clear pathways to provide proper heat dissipation; optional air ducts provide exhaust channels for high heat density applications



8 Optional Slack Spools – Slack management spools organize and manage patch cord slack; spools are available in side mount for single cabinet or center mount for ganged application



4 Grounding and Bonding – Entire cabinet is fully electrically bonded including equipment rails, doors and side panels; when combined with StructuredGround™ Grounding System, promotes protection of equipment and personnel



9 Cool Boot® Raised Floor Air Sealing Grommet – The raised floor air sealing grommet reduces bypass airflow and prevents debris from falling below the raised floor; grommets are available in different sizes for a variety of applications



5 Easily Accessible Casters and Leveling Legs – Leveling legs can be safely and easily adjusted and can retract into the cabinet frame; optional casters mount to side of posts for safe, easy field installation



10 Versatile Cable Routing – The CabRunner® Overhead Cable Routing System is a high capacity data cable pathway used directly over the Net-Access™ Cabinets; eliminates the need for multiple infrastructure elements, reducing installation time



Cable Capacity Chart

Channel	No Slack Spool							With Slack Spool						
	Channel Area		Cable Capacity*					Channel Area		Cable Capacity*				
	In. ²	cm ²	Cat. 6A SD (0.240")	Cat. 6A (0.300")	Cat. 6 (0.240")	Cat. 5e (0.225")	Fiber (3mm)	In. ²	cm ²	Cat. 6A SD (0.240")	Cat. 6A (0.300")	Cat. 6 (0.240")	Cat. 5e (0.225")	Fiber (3mm)
End	42.2	272.3	373	238	373	424	1,540	32.4	209.0	286	183	286	325	1,182
Center (ganged)	84.4	544.5	746	477	746	849	3,081	74.6	481.3	659	422	659	750	2,723

*Note: Capacities are based upon a fill rate of 40% to accommodate proper cable routing applications. All dimensions represent typical outer cable diameter in inches.

Net-Access™ Switch Cabinets

- Inset frame posts create large and accessible vertical pathways for routing cables
- Modular cable management fingers easily mount to the front and/or back of all four cabinet posts
- Designed with the use of CFD (computational fluid dynamics) analysis and thermal lab testing to optimize the thermal performance of network switches requiring side-to-side airflow
- Accommodate equipment mounting depths up to 25.9" (658mm)
- Innovative, fully integrated, electrically bonded cabinet with a single ground connection to guard against EMI and ESD, and provide a safe current path to ground

- Four adjustable equipment mounting rails – available in cage nut or #12-24 threaded with printed rack space identification
- Equipment rails have printed rack space numbering that can be oriented numbers up or down
- Durable black polyester epoxy powder coat finish
- 2,500 lbs. (1134 kg) load rating
- Cabinet ships assembled, one per pallet
- For the complete grounding solution, see the StructuredGround™ Kits for Cabinets selection guide on pages M.10 – M.11



CN1



CN2

Part Number	Part Description	Std. Pkg. Qty.
Net-Access™ 45 RU Switch Cabinets for Use in Hot Aisle/Cold Aisle Applications		
CN1	Cabinet frame with top panel. Tapped equipment rails (12-24). Dual hinge perforated front door opens to the left or right. Split perforated rear doors open in the middle to minimize door swing footprint. Solid side panels. (2) Two sets of #12-24 threaded equipment mounting rails. 45 RU cable management on front and rear of front posts. Dimensions: 84.0"H x 31.5"W x 41.1"D (2134mm x 800mm x 1044mm)	1
CN1NU	Cabinet frame with top panel. Tapped equipment rails (12-24). Dual hinge perforated front door opens to the left or right. Split perforated rear doors open in the middle to minimize door swing footprint. Solid side panels. (2) Two sets of #12-24 threaded equipment mounting rails – mounted numbers up. 45 RU cable management on front and rear of front posts. Dimensions: 84.0"H x 31.5"W x 41.1"D (2134mm x 800mm x 1044mm)	1
CN1CN	Cabinet frame with top panel. Cage nut rails (12-24). Dual hinge perforated front door opens to the left or right. Split perforated rear doors open in the middle to minimize door swing footprint. Solid side panels. (2) Two sets of #12-24 cage nut equipment mounting rails. 45 RU cable management on front and rear of front posts. Dimensions: 84.0"H x 31.5"W x 41.1"D (2134mm x 800mm x 1044mm)	1
CN1CNU	Cabinet frame with top panel. Cage nut rails (12-24) – mounted numbers up. Dual hinge perforated front door opens to the left or right. Split perforated rear doors open in the middle to minimize door swing footprint. Solid side panels. (2) Two sets of #12-24 cage nut equipment mounting rails – numbered up. 45 RU cable management on front and rear of front posts. Dimensions: 84.0"H x 31.5"W x 41.1"D (2134mm x 800mm x 1044mm)	1
CN1CNU	Cabinet frame with top panel. Split perforated front and rear doors open in the middle to minimize door swing footprint. Solid side panels. (2) Front cage nut equipment mounting rails – mounted numbers up. Rear extended cage nut equipment mounting rails – mounted numbers up. 29.0" rail span. 45 RU cable management on front and rear of front posts. Dimensions: 84.0"H x 31.5"W x 41.1"D (2134mm x 800mm x 1044mm)	1
CN2	Cabinet frame with top panel. Dual hinge perforated front door opens to the left or right. Split perforated rear doors open in the middle to minimize door swing footprint. Two sets of #12-24 threaded equipment mounting rails. 45 RU cable management on front and rear of front posts. Dimensions: 84.0"H x 31.5"W x 41.1"D (2134mm x 800mm x 1044mm)	1

White cabinets also available upon request. Please consult Panduit Customer Service for lead-times.

Net-Access™ Switch Cabinets (continued)



CN3



CN4



CN5

Part Number	Part Description	Std. Pkg. Qty.
CN2NU	Cabinet frame with top panel. Dual hinge perforated front door opens to the left or right. Split perforated rear doors open in the middle to minimize door swing footprint. Two sets of #12-24 threaded equipment mounting rails – numbered up. 45 RU cable management on front and rear of front posts. Dimensions: 84.0"H x 31.5"W x 41.1"D (2134mm x 800mm x 1044mm)	1
CN2CN	Cabinet frame with top panel. Cage nut rails (12-24). Dual hinge perforated front door opens to the left or right. Split perforated rear doors open in the middle to minimize door swing footprint. Two sets of #12-24 cage nut equipment mounting rails. 45 RU cable management on front and rear of front posts. Dimensions: 84.0"H x 31.5"W x 41.1"D (2134mm x 800mm x 1044mm)	1
CN2CNU	Cabinet frame with top panel. Cage nut rails (12-24) – mounted numbers up. Dual hinge perforated front door opens to the left or right. Split perforated rear doors open in the middle to minimize door swing footprint. Two sets of #12-24 cage nut equipment mounting rails – numbered up. 45 RU cable management on front and rear of front posts. Dimensions: 84.0"H x 31.5"W x 41.1"D (2134mm x 800mm x 1044mm)	1
CN2CNU	Cabinet frame with top panel. Dual hinge perforated front door opens to the left or right. Split perforated rear doors open in the middle to minimize door swing footprint. Front cage nut equipment mounting rails – mounted numbers up. Rear extended cage nut equipment mounting rails – mounted numbers up. 29.0" rail span. 45 RU cable management on front and rear of front posts. Dimensions: 84.0"H x 31.5"W x 41.1"D (2134mm x 800mm x 1044mm)	1
CN2C	Cabinet frame with top panel. Dual hinge perforated front door opens to the left or right. Split perforated rear doors open in the middle to minimize door swing footprint. Front cage nut equipment mounting rails – mounted numbers up. Rear extended cage nut equipment mounting rails – mounted numbers up. 29" rail span. 45 RU cable management on front and rear of front posts. Dimensions: 84.0"H x 31.5"W x 41.1"D (2134.0mm x 800.0mm x 1044.0mm)	1
CN3	Cabinet frame with top panel. Two sets of #12-24 threaded equipment mounting rails. 45 RU cable management on front and rear of front posts. Dimensions: 84.0"H x 31.5"W x 40.0"D (2134mm x 800mm x 1016mm)	1
CN3CN	Cabinet frame with top panel. Two sets of #12-24 cage nut equipment mounting rails. 45 RU cable management on front and rear of front posts. Dimensions: 84.0"H x 31.5"W x 40.0"D (2134.0mm x 800.0mm x 1016.0mm)	1
CN3CNU	Cabinet frame with top panel. Cage nut rails (12-24) – mounted numbers up. Two sets of #12-24 cage nut equipment mounting rails – numbered up. 45 RU cable management on front and rear of front posts. Dimensions: 84.0"H x 31.5"W x 40.0"D (2134mm x 800mm x 1044mm)	1
CN3CNU	Cabinet frame with top panel. Front cage nut equipment mounting rails – mounted numbers up. Rear extended cage nut equipment mount rails – mounted numbers up. 29" rail span. 45 RU cable management on front and rear of front posts. Dimensions: 84.0"H x 31.5"W x 40.0"D (2134mm x 800mm x 1016mm)	1
CN3C	Cabinet frame with top panel. Front cage nut equipment mounting rails – mounted numbers up. Rear extended cage nut equipment rails – mounted numbers up. 29" rail span. 45 RU cable management on front and rear of front posts. Dimensions: 84.0"H x 31.5"W x 40.0"D (2134.0mm x 800.0mm x 1044.0mm)	1
CN4	Cabinet frame with top panel. Split perforated front and rear doors open in the middle to minimize door swing footprint. Solid side panels. (2) Set of two #12-24 threaded equipment mounting rails. 45 RU cable management on front and rear of front posts. Dimensions: 84.0"H x 31.5"W x 40.0"D (2134mm x 800mm x 1017mm)	1

White cabinets also available upon request. Please consult Panduit Customer Service for lead-times.

Table continues on page L.14

**Net-Access™ Switch Cabinets (continued)**

Part Number	Part Description	Std. Pkg. Qty.
CN4C	Cabinet frame with top panel. Split perforated front and rear doors open in the middle to minimize door swing footprint. Solid side panels. (2) Front cage nut equipment mounting rails. Rear extended cage nut equipment rails provide overall rail span of 29" (736mm). 45 RU cable management on front and rear of front posts. Dimensions: 84.0"H x 31.5"W x 40.0"D (2134mm x 800mm x 1017mm)	1
CN5	Cabinet frame with top panel. Split perforated front and rear doors open in the middle to minimize door swing footprint. Set of two #12-24 threaded equipment mounting rails. 45 RU cable management on front and rear of front posts. Dimensions: 84.0"H x 31.5"W x 40.0"D (2134mm x 800mm x 1044mm)	1
CN5C	Cabinet frame with top panel. Split perforated front and rear doors open in the middle to minimize door swing footprint. Front cage nut equipment mounting rails. Rear extended cage nut equipment rails provide overall rail span of 29" (736mm). 45 RU cable management on front and rear of front posts. Dimensions: 84.0"H x 31.5"W x 40.0"D (2134mm x 800mm x 1044mm)	1

**CN12NU****Net-Access™ 42 RU Switch Cabinets for Use in Hot Aisle/Cold Aisle Applications**

CN12NU	42 available rack spaces. Cabinet frame with top panel. Dual hinge perforated front door opens to the left or right. Split perforated rear doors open in the middle to minimize door swing footprint. Solid side panels (2). Two sets of #12-24 threaded equipment mounting rails – mounted numbers up. 42 RU cable management on front and rear of front posts. Dimensions: 78.8"H x 31.5"W x 41.1"D (2000mm x 800mm x 1044mm)	1
CN22NU	42 available rack spaces. Cabinet frame with top panel. Dual hinge perforated front door opens to the left or right. Split perforated rear doors open in the middle to minimize door swing footprint. Two sets of #12-24 threaded equipment mounting rails – mounted numbers up. 42 RU cable management on front and rear of front posts. Dimensions: 78.8"H x 31.5"W x 41.1"D (2000mm x 800mm x 1044mm)	1
CN42NU	42 available rack spaces. Cabinet frame with top panel. Split perforated front and rear doors open in the middle to minimize door swing footprint. Solid side panels (2). Set of two #12-24 threaded equipment mounting rails – mounted numbers up. 42 RU cable management on front and rear of front posts. Dimensions: 84.0"H x 31.5"W x 40.0"D (2134mm x 800mm x 1017mm)	1
CN12CNNU	42 available rack spaces. Cabinet frame with top panel. Dual hinge perforated front door opens to the left or right. Split perforated rear doors open in the middle to minimize door swing footprint. Solid side panels (2). Two sets of cage nut equipment rails – mounted numbers up. 42 RU cable management on front and rear of front posts. Dimensions: 78.8"H x 31.5"W x 41.1"D (2000mm x 800mm x 1044mm)	1
CN22CNNU	42 available rack spaces. Cabinet frame with top panel. Dual hinge perforated front door opens to the left or right. Split perforated rear doors open in the middle to minimize door swing footprint. Two sets of cage nut equipment rails – mounted numbers up. 42 RU cable management on front and rear of front posts. Dimensions: 78.8"H x 31.5"W x 41.1"D (2000mm x 800mm x 1044mm)	1

White cabinets also available upon request. Please consult Panduit Customer Service for lead-times.

Net-Access™ Switch Cabinets (continued)

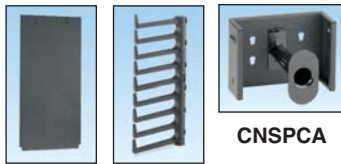

CNPS CNBRFK



CNSPE CNCSTR

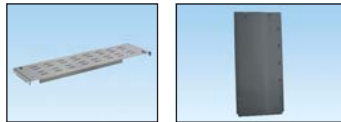

CSBA CNPSPT



CNFBB CNFBB4R

CNPP



CNFBBS

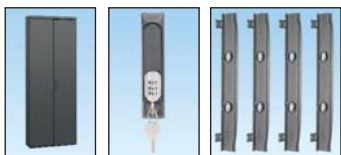

CVED32 CCL CNVBP
CNVBP2

Part Number	Part Description	Std. Pkg. Qty.
Net-Access™ Switch Cabinet Options and Accessories		
CNPS	Removable solid side panel with lockable push button latches.	1
CNBRFK	Network cabinet cable management finger kit, nine RU sections. Kit includes five left and five right finger sections to complete 45 RU on one side of post.	1
CNSPCA	Network cabinet center channel slack spool. Package includes one center spool and mounting bracket.	1
CNSPE	Net-Access™ Network Cabinet and 4 post rack end channel slack spools. Package includes one left and one right slack spool and mounting brackets.	1
CNCSTR	Network cabinet casters – set of four. Can be field installed without tipping cabinet. Adds 1.7" (43mm) to cabinet height.	1
CSBA	Network cabinet adjustable cable support bridge supports horizontal cable runs between Net-Access™ Cabinets.	1
CNPSPT	Removable side panel with pass-through holes and lockable push button latches.	1
CNPP	Removable cabinet perforated side panel with lockable push button latches.	1
CNFBB	Side cabinet cable management bracket for side mounting 19" EIA equipment.	1
CNFBB4R	Side cable management for mounting 19" EIA equipment, 4 RU. Comes with bend radius clips.	1
CNFBBS	Side cabinet bracket for mounting 19" EIA equipment.	1
CVED32	Vertical exhaust cabinet extension and solid rear split doors. Leveling legs and gasket kit included.	1
CCL	The cabinet combination lock is a 3 digit combination lock that can be installed on any Net-Access™ or Net-SERV® Cabinet dual hinge, single hinge or split door. This combination lock easily replaces the standard door handles. The 3 digit combination easily changes from the factory setting to a custom code. The lock also includes an integrated keyed override that is master-keyable.	1
CNVBP	45 RU Net-Access™ Switch Cabinet Vertical Blanking Panels with pass-through holes.	1
CNVBP2	42 RU Net-Access™ Switch Cabinet Vertical Blanking Panels with pass-through holes.	1
CNWS1224-C	#12-24 cage nut and screws.	100

Cisco^ Nexus 7018 Cabinet Solution

- Engineered to provide a best in class solution for Cisco Nexus 7018 switches
- Available for multiple architectures including: hot aisle/cold aisle applications, cold aisle containment applications, and vertical exhaust duct applications
- Offered in both 42 RU and 45 RU heights to meet your data center's height requirement
- Inlet duct, exhaust duct or vertical blanking panels are preinstalled on the cabinet
- Cabinet ships assembled, one per pallet



**Net-Access™
7018 Cabinets**

Part Number	Part Description	Std. Pkg. Qty.
-------------	------------------	----------------

Net-Access™ 42 RU and 45 RU 7018 Cabinets for Use in Hot Aisle/Cold Aisle Applications

CN3847018NU	Net-Access™ Network Cabinet for 7018 switch, 45 RU, #12-24 threaded rails, numbers up, intake and exhaust ducts, and cable management fingers. Dimensions: 39.5"W x 48.0"D x 84"H (1003mm x 1219mm x 2134mm)	1
CN5847018NU	Net-Access™ Network Cabinet for 7018 switch, 45 RU, #12-24 threaded rails, numbers up, split perforated front door, split perforated rear door, intake and exhaust ducts, and cable management fingers. Dimensions: 39.5"W x 48.9"D x 84"H (1003mm x 1242mm x 2134mm)	1
CN4847018NU	Net-Access™ Network Cabinet for 7018 switch, 45 RU, #12-24 threaded rails, numbers up, split perforated front door, split perforated rear door, side panels (2), intake and exhaust ducts, and cable management fingers. Dimensions: 39.5"W x 48.9"D x 84"H (1003mm x 1242mm x 2134mm)	1
CN48470182NU	Net-Access™ Network Cabinet for 7018 switch, 42 RU, #12-24 threaded rails, numbers up, split perforated front door, split perforated rear door, side panels (2), intake and exhaust ducts, and cable management fingers. Dimensions: 39.5"W x 48.9"D x 78.8"H (1003mm x 1242mm x 2000mm)	1
CN5847018CNUU	Net-Access™ Network Cabinet for 7018 switch, 45 RU, perforated split doors, no side panels, 7018 inlet and exhaust ducting, cage nut rails – mounted numbers up. Dimensions: 39.5"W x 48.9"D x 84.0"H (1003mm x 1242mm x 2134mm)	1

Net-Access™ 42 RU and 45 RU 7018 Cabinets for Use in Cold Aisle Containment Applications

CN484C7018NU	Net-Access™ Network Cabinet for 7018 switch, 45 RU, #12-24 threaded rails, numbers up, split perforated front door, split perforated rear door, side panels, intake duct, vertical blanking panels, and cable management fingers. Dimensions: 39.5"W x 48.9"D x 84"H (1003mm x 1242mm x 2134mm)	1
CN484C70182CNUU	Net-Access™ Network Cabinet for 7018 switch, 42 RU, perforated split doors, side panels (2), vertical blanking panels, 7018 inlet ducting, and cage nut rails – mounted numbers up. Dimensions: 39.5"W x 48.9"D x 78.8"H (1003mm x 1242mm x 2000mm)	1

Net-Access™ 45 RU 7018 Cabinets Vertical Exhaust Ready

CN584H7018	Net-Access™ Network Cabinet for 7018 switch, 45 RU, #12-24 threaded rails, numbers up, split perforated front door, solid split rear door, chimney ready top cap, intake duct, vertical blanking panels, and cable management fingers. Dimensions: 39.5"W x 48.9"D x 84"H (1003mm x 1242mm x 2134mm)	1
-------------------	---	---

Vertical Exhaust Ducting for VED Ready 7018 Cabinets

CVED40VE	Vertical exhaust duct for Net-Access™ 7018 cabinet, height adjustable from 42.0"(1067mm) to 70.0" (1778mm).	1
CVED40VEN	Vertical exhaust duct for Net-Access™ 7018 cabinet, height adjustable from 21.0"(534mm) to 45.0" (1143mm).	1



CVED40VE

^Cisco is a registered trademark of Cisco Technology, Inc.

White cabinets also available upon request. Please consult Panduit Customer Service for lead-times.

Net-Access™ Extended Switch Cabinets Recommended for Cisco^ Nexus 7010 Switch

- Engineered to provide a best in class solution for Cisco^ Nexus 7010 switches
- Offered in both 42 RU and 45 RU heights to meet your data center's height requirement
- 31.5"W x 48"D (800mm x 1219mm) Frame
- Cabinet ships assembled, one per pallet



Net-Access™
7010 Cabinets

Part Number	Part Description	Std. Pkg. Qty.
-------------	------------------	----------------

Net-Access™ 42 RU and 45 RU Extended Switch Cabinets for Use in Hot Aisle/Cold Aisle Applications

CN18NU	Net-Access™ Extended Switch Cabinet, front dual hinge door, rear split doors, (2) side panels, #12-24 tapped equipment rails mounted numbers up. Dimensions: 31.5"W x 48.9"D x 84.0"H (800mm x 1242mm x 2134mm) 45 RU	1
CN182CNU	Net-Access™ Extended Switch Cabinet, front dual hinge door, rear split doors (2) cage nut equipment rails – mounted numbers up. Dimensions: 31.5"W (800mm) x 48.9"D (1242mm) x 78.8"H (2000mm) 42 RU	1
CN28	Net-Access™ Extended Switch Cabinet, front dual hinge door, rear perforated split doors, no side panels, #12-24 rails. Dimensions: 31.5"W x 48.9"D x 84"H (800mm x 1242mm x 2134mm) 45 RU	1
CN28NU	Net-Access™ Extended Switch Cabinet, front dual hinge door, rear perforated split doors, no side panels, #12-24 rails – mounted numbers up. Dimensions: 31.5"W x 48.9"D x 84.0"H (800mm x 1242mm x 2134mm) 45 RU	1
CN28CNU	Net-Access™ Extended Switch Cabinet, front dual hinge door, rear split doors, no side panels, cage nut equipment rails mounted numbers up. Dimensions: 31.5"W x 48.9"D x 84.0"H (800mm x 1242mm x 2134mm) 45 RU	1
CN28CNU	Net-Access™ Extended Switch Cabinet, single perforated front door, split perforated rear doors, front cage nut equipment mounting rails – mounted numbers up, rear extended cage nut equipment mounting rails create a 29.0" mounting range and cable management on front and rear of front posts. Dimensions: 31.5"W x 48.0"D x 84.0"H (800mm x 1219mm x 2134mm) 45 RU	1
CN348	Net-Access™ Extended Switch Cabinet, no doors, no side panels. #12-24 rails. Dimensions: 31.5"W x 48"D x 84"H (800mm x 1219mm x 2134mm) 45 RU	1

Net-Access™ 42 RU and 45 RU Extended Switch Cabinets for Use in Cold Aisle Containment Applications

CN28BNU	Net-Access™ Extended Switch Cabinet, front dual hinge door, rear perforated split doors, no side panels, vertical blanking panels, #12-24 rails – mounted numbers up. Dimensions: 31.5"W x 48.9"D x 84"H (800mm x 1242mm x 2134mm) 45 RU	1
CN28BCNU	Net-Access™ Extended Switch Cabinet, front dual hinge door, rear perforated split doors, no side panels, vertical blanking panels, cage nut rails – mounted numbers up. Dimensions: 31.5"W x 48.9"D x 84.0"H (800mm x 1242mm x 2134mm) 45 RU	1

^Cisco is a registered trademark of Cisco Technology, Inc.
White cabinets also available upon request. Please consult Panduit Customer Service for lead-times.

Table continues on page L.18

**Net-Access™ Extended Switch Cabinets Recommended for
Cisco^ Nexus 7010 Switch (continued)**

Part Number	Part Description	Std. Pkg. Qty.
CN28BLNU	Net-Access™ Extended Switch Cabinet, front dual hinge door, rear perforated split doors, (1) side panel – left side, vertical blanking panels, #12-24 rails – mounted numbers up. Dimensions: 31.5"W x 48.9"D x 84"H (800mm x 1242mm x 2134mm) 45 RU	1
CN28BLCNNU	Net-Access™ Extended Switch Cabinet, front dual hinge door, rear perforated split doors, (1) side panel – left side, vertical blanking panels, cage nut rails – mounted numbers up. Dimensions: 31.5"W x 48.9"D x 84"H (800mm x 1242mm x 2134mm) 45 RU	1
CN282BCNNU	Net-Access™ Extended Switch Cabinet, front dual hinge door, rear perforated split doors, cage nut rails (2) – mounted numbers up. 42 RU cable management on front and rear of front posts. Dimensions: 31.5"W x 48.9"D x 78.8" (800mm x 1242mm x 2000mm)	1

Net-Access™ 45 RU Extended Switch Cabinets for Use in Vertical Exhaust Duct Applications

CN28HBNU	Net-Access™ VED Cabinet, front dual hinge door, rear solid split door, high flow top cap vertical blanking panels, #12-24 rails – mounted numbers up. Dimensions: 31.5"W x 48.9"D x 84"H (800mm x 1242mm x 2134mm) 45 RU	1
CN28HBCNNU	45 RU, 800 Wide x 1200 Deep - Vertical Exhaust Duct Switch cabinet, no side panels, vertical blanking panels, cage nut equipment rails – mounted numbers up	1

Net-Access™ Vertical Exhaust Duct

CVED32VE	Variable duct extension is infinitely adjustable between 42.0" (1067mm) to 70.0" (1778mm).	1
CVED32VES	Variable short duct extension is infinitely adjustable between 20.0" (508mm) to 36.0" (914mm).	1

Net-Access™ 7010 Switch Cabinet Accessories

CVPDUB48	Bracket for vertical POU mounting to the side of the Net-Access™ 32" x 48" Cabinet rear extension (kit of two).	1
-----------------	---	---

^Cisco is a registered trademark of Cisco Technology, Inc.

White cabinets also available upon request. Please consult Panduit Customer Service for lead-times.



CVED32VE

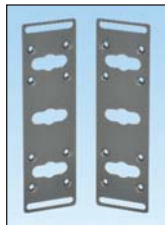

CVPDUB48

Net-Access™ Server Cabinet System Roadmap

The Net-Access™ Server Cabinet provides scalable thermal management for low to high heat density applications. Superior cable management eliminates cable and power cord congestion behind the servers allowing server fans to more efficiently exhaust air from the cabinet. Air blocking features ensure that cold air is directed to the servers.

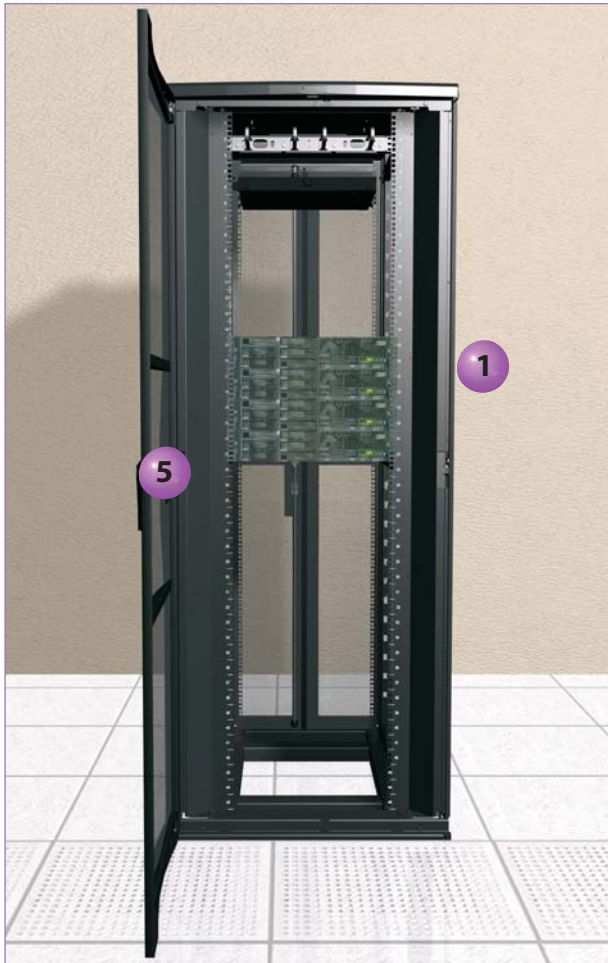

Front View



Rear View

- 1** Net-Access™ Server Cabinet
(pages L.20 and L.22) 

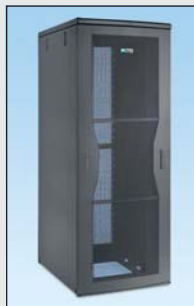

- 3** GridRunner™ Underfloor Cable
Routing System
(page J.75)

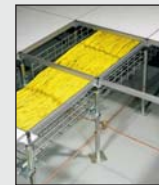

- 2** Cool Boot® Raised Floor
Air Sealing Grommet
(pages L.90 and L.91)



- 4** Vertical Patch Panel Mounting
(page L.22)



- 5** CNDSh Single Hinge Door
(page L.22) 



Net-Access™ Server Cabinets

- Inset frame posts create large and accessible vertical pathways for routing cables and mounting vertical patch panels and Power Outlet Units

- Include vertical blanking panels to block bypass air and direct cold air through servers

- Modular cable management finger sections manage cables for greater routing flexibility

- Innovative, fully integrated, electrically bonded cabinet with a single ground connection to guard against EMI and ESD, and provide a safe current path to ground

- All welded frame construction

- Adjustable rear cage nut mounting rails
- Doors include keyed swing latches
- Side panels include keyed pushbutton latches
- Equipment mounting depths up to 29" (736.6mm)
- Durable black polyester epoxy powder coat finish
- UL Listed 2500 lbs. (1134 kg) load rating
- Cabinet ships assembled, one per pallet
- For the complete grounding solution, see the StructuredGround™ Kits for Cabinets

**CS1****CS2****CS3**

Part Number	Part Description	Std. Pkg. Qty.
Net-Access™ 45 RU Server Cabinets		
CS1	Cabinet frame with top panel. Single hinge perforated front door. Split perforated rear doors open in the middle to minimize door swing footprint. Solid side panels. Two sets of cage nut equipment mounting rails. 45 RU cable management on rear of rear posts. One set of POU mounting brackets. Dimensions: 84.0"H x 31.5"W x 41.1"D (2134mm x 800mm x 1044mm)	1
CS1NU	Cabinet frame with top panel. Single hinge perforated front door. Split perforated rear doors open in the middle to minimize door swing footprint. Solid side panels. Two sets of cage nut equipment mounting rails installed numbered up. 45 RU cable management on rear of rear posts. One set of POU mounting brackets. Dimensions: 84.0"H x 31.5"W x 41.1"D (2134mm x 800mm x 1044mm)	1
CS1RNU	Cabinet frame with top panel. Single hinge perforated front door. Split perforated rear doors open in the middle to minimize door swing footprint. Solid side panels. Two sets of cage nut equipment mounting rails installed numbered up. 45 RU cable management on rear of rear posts. One set of POU mounting brackets. Four installed casters. Dimensions: 84.0"H x 31.5"W x 41.1"D (2134mm x 800mm x 1044mm)	1
CS2	Cabinet frame with top panel. Single hinge perforated front door. Split perforated rear doors open in the middle to minimize door swing footprint. Two sets of cage nut equipment mounting rails. 45 RU cable management on rear of rear posts. One set of POU mounting brackets. Dimensions: 84.0"H x 31.5"W x 41.1"D (2134mm x 800mm x 1044mm)	1
CS2NU	Cabinet frame with top panel. Single hinge perforated front door. Split perforated rear doors open in the middle to minimize door swing footprint. Two sets of cage nut equipment mounting rails installed numbered up. 45 RU cable management on rear of rear posts. One set of POU mounting brackets. Dimensions: 84.0"H x 31.5"W x 41.1"D (2134mm x 800mm x 1044mm)	1
CS3	Cabinet frame with top panel. Two sets of cage nut equipment mounting rails. 45 RU cable management on rear of rear posts. One set of POU mounting brackets. Dimensions: 84.0"H x 31.5"W x 40.0"D (2134mm x 800mm x 1016mm)	1

White cabinets also available upon request. Please consult Panduit Customer Service for lead-times.

Net-Access™ Server Cabinets (continued)



CS4RNU



CS5

Part Number	Part Description	Std. Pkg. Qty.
CS3NU	Cabinet frame with top panel. Two sets of cage nut equipment mounting rails installed numbered up. 45 RU cable management on rear of rear posts. One set of POU mounting brackets. Dimensions: 84.0"H x 31.5"W x 40.0"D (2134mm x 800mm x 1016mm)	1
CS4RNU	Cabinet frame with top panel. Two split perforated rear doors open in the middle to minimize door swing footprint. Solid side panels. Two sets of cage nut equipment mounting rails numbered up. 45 RU cable management on rear of rear posts. One set of POU mounting brackets. Four installed casters. One set of vertical blanking panels. Dimensions: 84.0"H x 31.5"W x 41.1"D (2134mm x 800mm x 1044mm)	1
CS5	Cabinet frame with top panel. Split perforated front doors open in the middle to minimize door swing footprint. Split perforated rear doors open in the middle to minimize door swing footprint. Two sets of cage nut equipment mounting rails. 45 RU cable management on rear of rear posts. One set of POU mounting brackets. Dimensions: 84.0"H x 31.5"W x 41.1"D (2134mm x 800mm x 1044mm)	1

Net-Access™ 42 RU Server Cabinets

CS12NU	42 available rack spaces. Cabinet frame with top panel. Single hinge perforated front door. Split perforated rear doors open in the middle to minimize door swing footprint. Solid side panels (2). Two sets of cage nut equipment mounting rails— mounted numbers up. 42 RU cable management on rear of rear posts. One set of POU mounting brackets. Dimensions: 78.8"H x 31.5"W x 41.1"D (2000mm x 800mm x 1044mm)	1
CS22NU	42 available rack spaces. Cabinet frame with top panel. Single hinge perforated front door. Split perforated rear doors open in the middle to minimize door swing footprint. Two sets of cage nut equipment mounting rails – mounted numbers up. 42 RU cable management on rear of rear posts. One set of POU mounting brackets. Dimensions: 78.8"H x 31.5"W x 41.1"D (2000mm x 800mm x 1044mm)	1

Net-Access™ 42 RU and 45 RU Extended Server Cabinets

CS28	Net-Access™ Extended Server Cabinet, front single hinge door, rear perforated split doors, no side panels, cage nut rails. Dimensions: 31.5"W x 48.9"D x 84.0"H (800mm x 1242mm x 2134mm) 45 RU	1
CS28NU	Net-Access™ Extended Server Cabinet, front single hinge door, rear perforated split doors, no side panels, cage nut rails – mounted numbers up. Dimensions: 31.5"W x 48.9"D x 84.0"H (800mm x 1242mm x 2134mm) 45 RU	1
CS28LNU	Net-Access™ Extended Server Cabinet, front single hinge door, rear perforated split doors, (1) side panel – left side, cage nut rails – mounted numbers up. Dimensions: 31.5"W x 48.9"D x 84.0"H (800mm x 1242mm x 2134mm) 45 RU	1

White cabinets also available upon request. Please consult Panduit Customer Service for lead-times.

Table continues on page L.22

 **Net-Access™ Server Cabinets (continued)**



CS18HNU

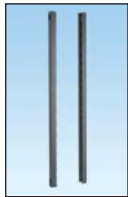

CSRCE



CNDSH



CVPDUB



CVPPB



CNCSTR

Part Number	Part Description	Std. Pkg. Qty.
CS348	Net-Access™ Extended Server Cabinet, no doors, no side panels, cage nut rails. Dimensions: 31.5"W x 48.0"D x 84"H (800mm x 1219mm x 2134mm) 45 RU	1
CS348NU	Net-Access™ Extended Server Cabinet, vertical blanking panels, cage nut rails – mounted numbers up. Dimensions: 31.5"W x 48.0"D x 84.0"H (800mm x 1219mm x 2134mm) 45 RU	0
CS182NU	Net-Access™ Extended Server Cabinet, single hinge front door, split perforated rear doors, two sets of cage nut equipment mounting rails – mounted numbers up, 42 RU cable management on rear of rear posts, and one set of POU mounting brackets. Dimensions: 78.8"H x 31.5"W x 48.9"D (2000mm x 800mm x 1242mm)	1
CS282NU	Net-Access™ Extended Server Cabinet, single hinge perforated front door, split perforated rear doors, two sets of cage nut equipment mounting rails – mounted numbers up, 42 RU cable management on rear of rear posts, and one set of POU mounting brackets. Dimensions: 78.8"H x 31.5"W x 48.9"D (2000mm x 800mm x 1242mm)	1

Net-Access™ 45 RU Extended Server Cabinets for Use in Vertical Exhaust Duct Applications

CS18HNU	Net-Access™ Extended Server Cabinet, front single hinge door, rear solid split door, (2) side panels, vertical blanking panels, cage nut rails – mounted numbers up. Dimensions: 31.5"W x 48.9"D x 84"H (800mm x 1242mm x 2134mm) 45 RU	1
CS28HNU	Net-Access™ Extended Server Cabinet, front single hinge door, rear solid split door, no side panels, vertical blanking panels, cage nut rails – mounted numbers up. Dimensions: 31.5"W x 48.9"D x 84"H (800mm x 1242mm x 2134mm) 45 RU	1

Net-Access™ Server Cabinet Options and Accessories

CSRCE	Extended front server cabinet cage nut equipment mounting rails, sold in pairs.	1
CNDSH	Single hinge door quickly reverses from left-hinging to right-hinging for increased data center design flexibility. Open perforated design enables optimum airflow to equipment.	1
CVPDUB	Bracket for vertical POU mounting to the side of the Net-Access™ Cabinet posts or 4 post racks (kit of two).	1
CVPPB	Bracket to vertically mount 1 RU EIA 19" copper and fiber patch panels to the side of the Net-Access™ Cabinet posts or 4 post racks.	1
CNCSTR	Network cabinet casters – set of four. Can be field installed without tipping cabinet. Adds 1.7" (43mm) to cabinet height.	1

White cabinets also available upon request. Please consult Panduit Customer Service for lead-times.

Net-Access™ Vertical Exhaust System Roadmap

Innovative Net-Access™ Vertical Exhaust System channels heat from server exhaust directly to the data center return plenum. By managing heat at the source the duct increases CRAC unit efficiency and significantly lowers operating expenses.

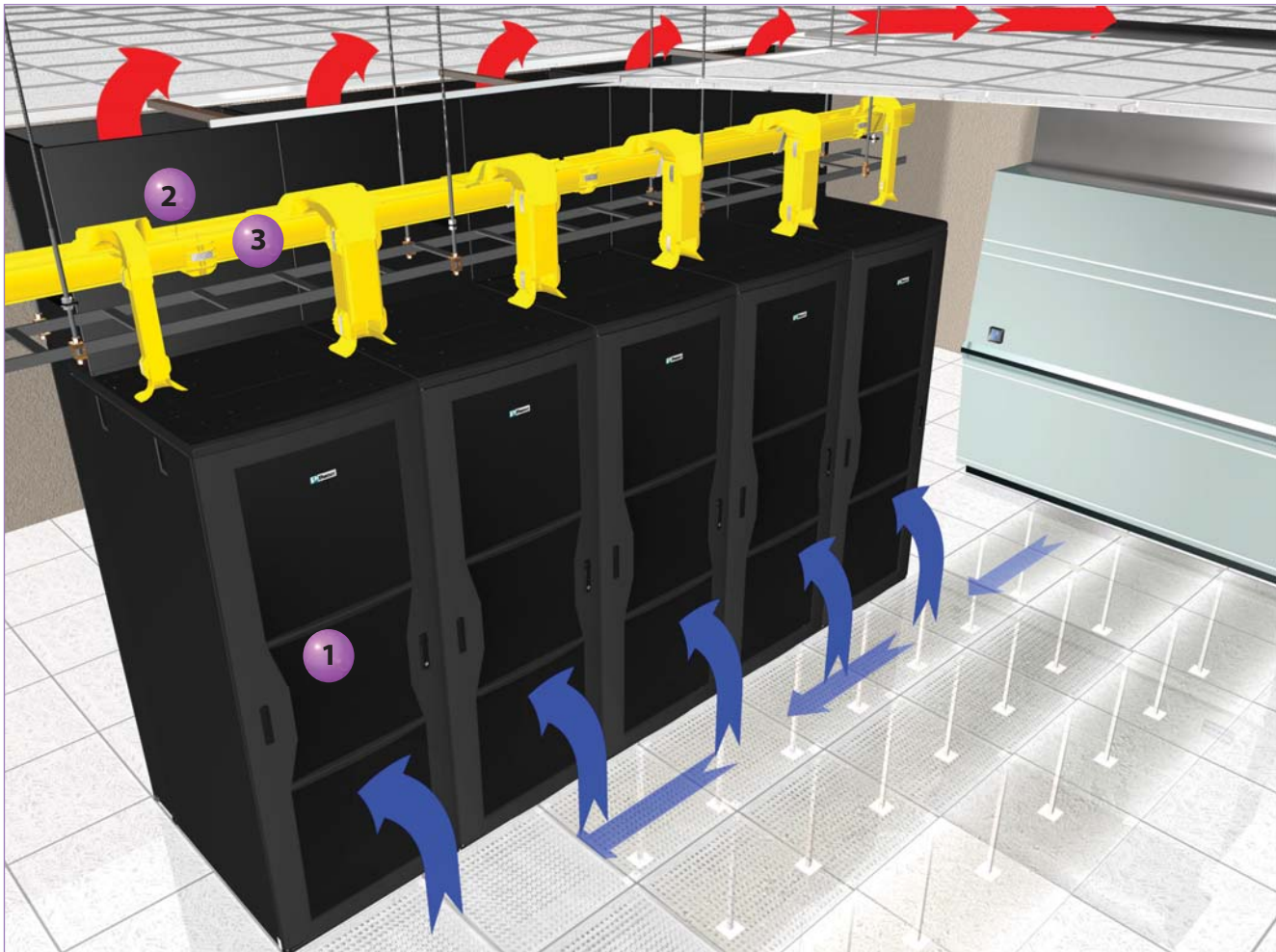

1 Net-Access™ Server Cabinet
(pages L.20 and L.22) 

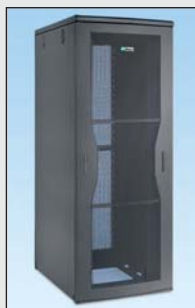

3 FiberRunner® Cable Routing System
(page J.1)



2 CVED32VE Variable Duct Extension
(page L.18)



A.
System
Overview

B.
Copper
Systems

C.
Fiber
Optic
Systems

D.
Power
over
Ethernet

E.
Zone
Cabling

F.
Wireless

G.
Outlets

H.
Media
Distribution

I.
Physical
Infrastructure
Management

J.
Overhead &
Underfloor
Routing

K.
Surface
Raceway

L.
Cabinets,
Racks &
Cable
Management

M.
Grounding &
Bonding

N.
Industrial

O.
Labeling &
Identification

P.
Cable
Management
Accessories

Q.
Index

NEW! Net-Contain™ Cold Aisle Containment System

The Net-Contain™ System creates a structure including end-of-row dual sliding doors and ceiling panels that enclose the cold aisle between rows of Panduit 42 RU or 45 RU Net-Access™ and Net-SERV® Cabinets to prevent mixing of cold and hot air, optimizing cool air delivery.

- Reduces cooling energy costs up to 42%
- Up to 20kW+ cabinet heat load
- Compatible with numerous Panduit product lines including CabRunner®, FiberRunner®, and Wyr-Grid® Cable Routing Systems



Integral Low Profile Ceiling Structure

- Available in 4 ft. (1200mm) or 6 ft. (1800mm) lengths of 600mm, 700mm, 800mm widths
- Access holes allow fire suppression to enter the containment
- Available in black or white frame structure

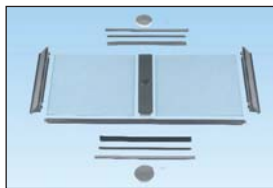

CXCAC08F06IRBL

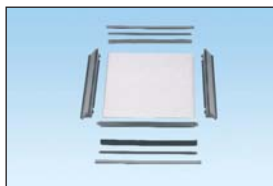

NSCAC06F04IRBL

Part Number	Part Description	Std. Pkg. Qty.
CXCAC08F04IRBL	Net-Contain™ Cold Aisle Containment Integral Roof for 800mm wide Net-Access™ Switch and Server Cabinets with 4' (1200mm) aisle width. Includes 4' low profile wall/ceiling kits.	1
CXCAC08F06IRBL	Net-Contain™ Cold Aisle Containment Integral Roof for 800mm wide Net-Access™ Switch and Server Cabinets with 6' (1800mm) aisle width. Includes 6' low profile wall/ceiling kits.	1
NSCAC07F04IRBL	Net-Contain™ Cold Aisle Containment Integral Roof for 700mm wide Net-SERV® Cabinet with 4' (1200mm) aisle width. Includes 4' low profile wall/ceiling kits.	1
NSCAC07F06IRBL	Net-Contain™ Cold Aisle Containment Integral Roof for 700mm wide Net-SERV® Cabinet with 6' (1800mm) aisle width. Includes 6' low profile wall/ceiling kits.	1
NSCAC06F04IRBL	Net-Contain™ Cold Aisle Containment Integral Roof for 600mm wide Net-SERV® Cabinet with 4' (1200mm) aisle width. Includes 4' low profile wall/ceiling kits.	1
NSCAC06F06IRBL	Net-Contain™ Cold Aisle Containment Integral Roof for 600mm wide Net-SERV® Cabinet with 6' (1800mm) aisle width. Includes 6' low profile wall/ceiling kits.	1

End of Row Dual Sliding Door Solution

- Can be installed in either a 4 ft. (1200mm) or 6 ft. (1800mm) aisle
- Mount to either Net-Access™ or Net-SERV® Cabinets
- Easy access to cabinet aisle area
- Damper keeps doors from slamming closed and ensures that the doors stay closed
- Uses gravity to automatically close doors
- Available in black or white frame structure



NACACT5F08DSBL

Part Number	Part Description	Std. Pkg. Qty.
NACACT5F08DSBL	Net-Contain™ Cold Aisle Containment Dual Sliding Door for Net-SERV® and Net Access™ Server and Switch Cabinets. Accommodates 4' (1200mm) up to 6' (1800mm) aisle widths, 42 RU up to 45 RU.	1

Thermal Ducting Solutions

Inlet Ducts

- Cisco compatible
- Passive duct solutions do not require additional energy consumption
- Designed using CFD (Computational Fluid Dynamics) validating thermal performance
- Provides a consistent cold air path directly to the switch
- Allows access to power supplies and fan blades minimizing network downtime
- Black powder coat finish



CDE1



CDE2



CNLTD21B2



CNLTD52A2



CNLTD142A3

CNLTD72A3



Part Number	Part Description	Std. Pkg. Qty.
CDE1	One rack unit air inlet duct that resides below the switch provides cold aisle airflow to Cisco^ 4948, 4928, and 4924. Optimized for use in server cabinet applications.	1
CDE2	Two rack unit air inlet duct that resides in-line and below switch provides cold aisle airflow to Cisco^ Nexus N2K-C2148T-1GE, N2K-C2248TP-1GE, and N2K-C2232PP-10GE fabric extenders and Cisco^ WS-C4948E-F, WS-C4948E-F-S, and WS-C4948E-F-E. Optimized for use in server cabinet applications.	1
CNLTD21B2	Two rack unit air inlet duct that resides below switch. Designed for Cisco^ 4900M switch. Duct allows switch ports to face either hot or cold aisle depending on server or switch cabinet application.	1
CNLTD52A2	Net-Access™ Cabinet Air Inlet Duct for high heat density configurations. Duct solution includes two rack unit inlet ducts above and below the switch. Designed for Cisco^ 6504E switch.	1
CNLTD142A3	Cisco^ Nexus 7009 duct delivers cold air to the switch side inlet. This duct consists of 2 inlet ducts and 1 side duct.	1
CNLTD72A3	Net-Access™ or Net-SERV® Cabinet Air Inlet Duct for high heat density configurations. Duct solution includes three rack unit inlet ducts above and below the switch. Designed for Cisco^ 9506 switch.	1

^Cisco is a registered trademark of Cisco Technology, Inc.

Exhaust Ducts

- Cisco compatible
- Passive duct solutions do not require additional energy consumption
- Designed using CFD (Computational Fluid Dynamics) validating thermal performance
- Provides a consistent hot air exhaust path minimizing recirculation within the cabinet
- Allows access to power supplies and fan blades minimizing network downtime
- Black powder coat finish



CNAE1

Part Number	Part Description	Std. Pkg. Qty.
CNAE1	Net-Access™ Cabinet Exhaust Duct for high heat density configurations. Designed for Cisco^ 6509 switch.	1
CNAE2	Net-Access™ Cabinet Exhaust Duct for high heat density configurations. Designed for Cisco^ 9513 storage area network switch.	1
CNAE3	Net-Access™ Cabinet Exhaust Duct for high heat density configurations. Designed for Cisco^ 6513 switch.	1

^Cisco is a registered trademark of Cisco Technology, Inc.



CabRunner[®] Overhead Cable Routing System

- Wide molded design provides a high capacity pathway that is self-supporting and does not need secondary mounting infrastructure
- Integral spillouts align with cable inlets on cabinet and provide 3" (75mm) bend radius control
- Clean, simple design complements Net-Access[™] Cabinets providing greater data center aesthetics
- Designed specifically for use with Net-Access[™] Switch and Server Cabinets

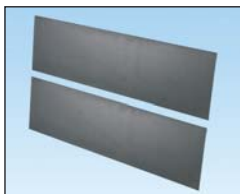
**CRB6BL****CRB6VEDBL****CRBRDGBL****CRB6ECBL****CRTB****CRVEDTB**

Part Number	Part Description	Std. Pkg. Qty.	Std. Ctn. Qty.
Base Unit			
CRB6BL	CabRunner [®] Overhead Cable Routing System Base Unit with 6" (150mm) high wall. Supplied with shroud and fasteners required for assembly to Net-Access [™] Cabinets.	1	—
CRB6VEDBL	CabRunner [®] Overhead Cable Routing System Base Unit with 6" (150mm) high wall. Supplied with a shroud and fasteners required for assembly to Net-Access [™] Cabinets with a vertical exhaust duct.	1	—
Bridge Insert			
CRBRDGBL	CabRunner [®] Overhead Cable Routing System Bridge Insert. Snaps into CRB6BL to cover unused cable spillouts and provide bend radius control for adjacent cabinet. Two inserts required for each opening in CabRunner [®] Base Unit.	1	5
End Cap for Net-Access[™] Cabinet			
CRB6ECBL	CabRunner [®] Overhead Cable Routing System End Cap. Snaps onto the CRB6BL CabRunner [®] Base, to close off the open ends of the Panduit [®] Net-Access [™] Cabinet lineup. (Sold in pairs to accommodate each end of a cabinet line up). No tools required.	2	—
Trapeze Bracket			
CRTB	CabRunner [®] Overhead Cable Routing System Trapeze Bracket. Used to provide a mounting structure for integrating FiberRunner [®] Cable Routing System to the base unit.	1	—
CRVEDTB	CabRunner [®] Overhead Cable Routing System Trapeze Bracket. Used to provide a mounting structure for integrating FiberRunner [®] Cable Routing System to the base unit on Net-Access [™] Cabinets with a vertical exhaust duct.	1	—

Net-SERV® Cabinets

- 1200mm (48") depth and 1070mm (42.1") depth
- Two sets, cage nut, infinitely adjustable equipment mounting rails, 50 #12-24 cage nuts and screws included
- Printed rack space identification on front and back of rails, default is numbers up, may be field adjusted to numbers down
- Equipment mounting depth up to 42" (1067mm)
- Doors include keyed swing handles
- Side panels include keyed locks
- POU mounting brackets included to mount two POU's
- Vertical blanking panels installed
- Easily adjustable leveling legs installed
- Ganging brackets included
- Anti-tip brackets included
- Available in four configuration options: Basic, Standard Density, High Density, and Vertical Patching
- Durable black polyester epoxy powder coat finish
- All welded frame construction
- 2500 lbs. (1134 kg) load rating
- Removable top cap included
- Cabinet ships assembled, one per pallet
- Optional casters available
- Optional vertical exhaust duct for maximum energy efficiency

Part Number Example:

S	7	5	2	C	1	2	9	F	V
Series	Width	Height	Depth	Rails	Front Doors	Back Doors	Side Panel	Cable Management	Top Panel
S = Server	6 = 600mm (23.6") 7 = 700mm (27.6")	2 = 42RU 5 = 45RU	2 = 1200mm (47.2") 0 = 1070mm (42.1")	C = Cage Nuts, Numbers Up	1 = Perf. Full Single Hinge	2 = Perforated Split 3 = Solid Full Single Hinge	1 = One Side Panel 2 = Two Side Panels 9 = No Side Panels	F = Standard Density – Left and Right Fingers H = High Density – Four Cable Management Panels P = Vertical Patch B = Basic – No Cable Mgmt.	V = Vertical Exhaust Duct (VED included) VR = Vertical Exhaust Duct (VED not included)

Basic Configuration

- Cabinet provided without cable management
- Includes brackets for mounting two vertical power outlet units



Part Number	Part Description	Width		Height		No. of Rack Spaces	Std. Pkg. Qty.
		In.	mm	In.	mm		
Net-SERV® 1200mm Deep Cabinets							
S722C122B	Cabinet with full perforated front door. Split perforated rear door. Solid side panels.	28	700	78	1984	42	1
S752C122B	Cabinet with full perforated front door. Split perforated rear door. Solid side panels.	28	700	83	2118	45	1
S622C122B	Cabinet with full perforated front door. Split perforated rear door. Solid side panels.	24	600	78	1984	42	1
S652C122B	Cabinet with full perforated front door. Split perforated rear door. Solid side panels.	24	600	83	2118	45	1
Net-SERV® 1070mm Deep Cabinets							
S620C122B	Cabinet with full perforated front door. Split perforated rear door. Solid side panels.	24	600	78	1984	42	1
S620C129B	Cabinet with full perforated front door. Split perforated rear door. Solid side panels.	24	600	78	1984	42	1

White cabinets also available upon request. Please consult Panduit Customer Service for lead-times.

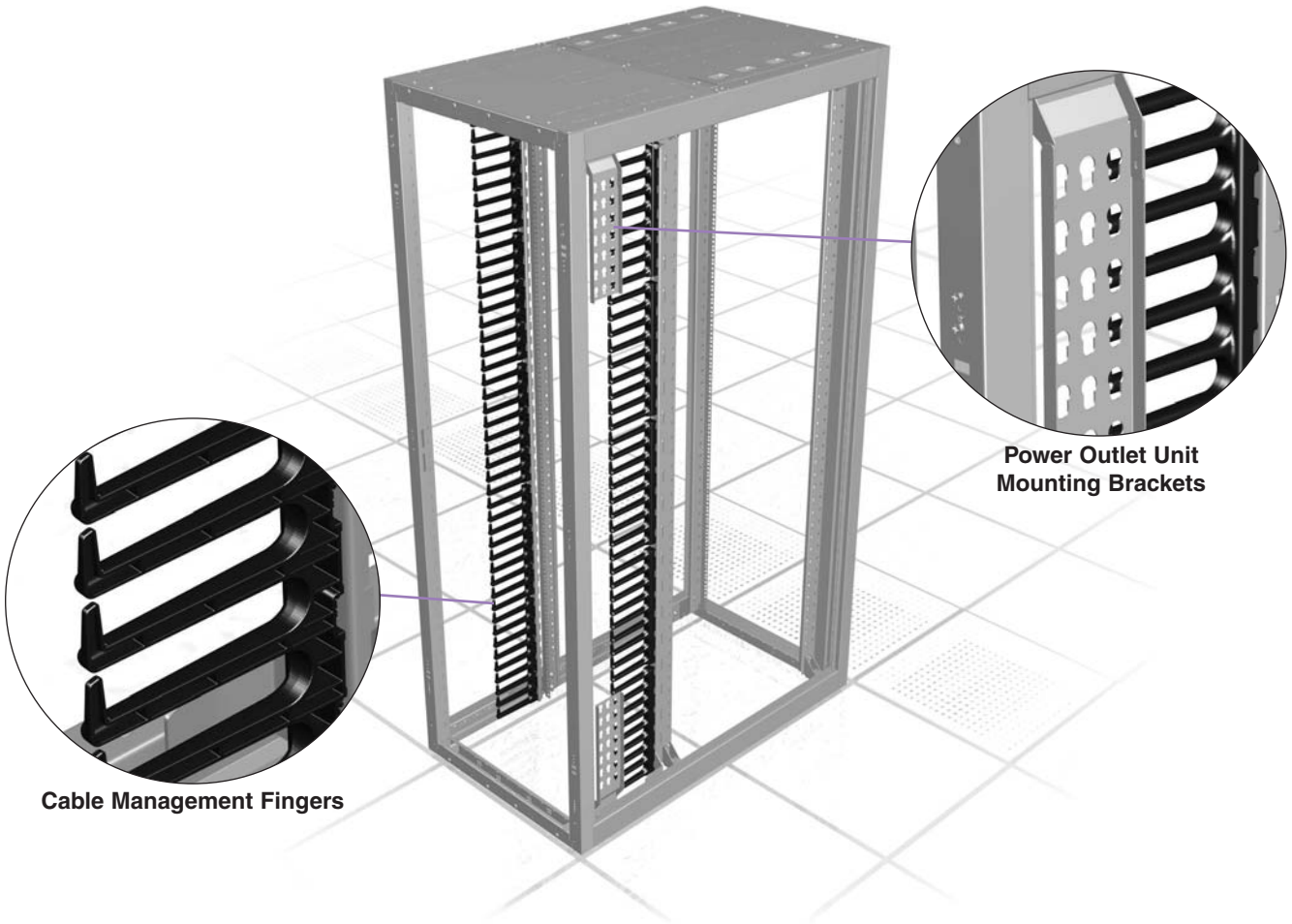

Standard Density Cable Management Configuration

- Cabinet supplied with two sets of cable management fingers



Part Number	Part Description	Width		Height		No. of Rack Spaces	Std. Pkg. Qty.
		In.	mm	In.	mm		
S722C122F	Cabinet with full perforated front door. Split perforated rear door. Solid side panels.	28	700	78	1984	42	1
S752C122F		28	700	83	2118	45	1
S622C122F		24	600	78	1984	42	1
S652C122F		24	600	83	2118	45	1
S722C129F	Cabinet with full perforated front door. Split perforated rear door. No side panels.	28	700	78	1984	42	1
S752C129F		28	700	83	2118	45	1
S622C129F		24	600	78	1984	42	1
S652C129F		24	600	83	2118	45	1

White cabinets also available upon request. Please consult Panduit Customer Service for lead-times.

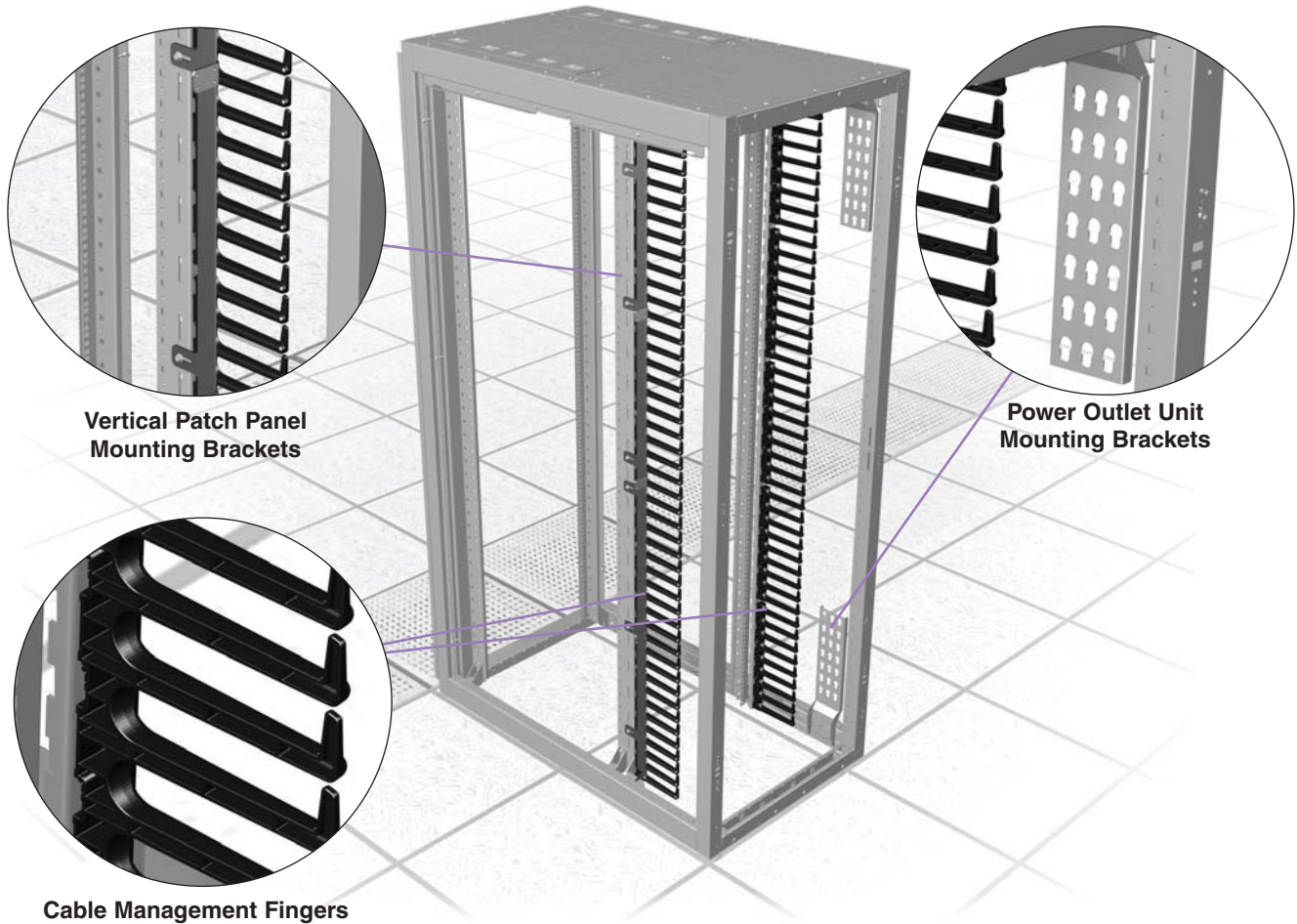

Vertical Patch Panel Mounting Brackets

Power Outlet Unit Mounting Brackets

Cable Management Fingers

Vertical Patch Cable Management Configuration

- Cabinet supplied with cable management fingers and vertical 19" EIA brackets



Part Number	Part Description	Width		Height		No. of Rack Spaces	Std. Pkg. Qty.
		In.	mm	In.	mm		
S722C122P	Cabinet with full perforated front door. Split perforated rear door.	28	700	78	1984	42	1
S752C122P	Solid side panels.	28	700	83	2118	45	1
S722C129P	Cabinet with full perforated front door. Split perforated rear door.	28	700	78	1984	42	1
S752C129P	No side panels.	28	700	83	2118	45	1

White cabinets also available upon request. Please consult Panduit Customer Service for lead-times.

A. System Overview

B. Copper Systems

C. Fiber Optic Systems

D. Power over Ethernet

E. Zone Cabling

F. Wireless

G. Outlets

H. Media Distribution

I. Physical Infrastructure Management

J. Overhead & Underfloor Routing

K. Surface Raceway

L. Cabinets, Racks & Cable Management

M. Grounding & Bonding

N. Industrial

O. Labeling & Identification

P. Cable Management Accessories

Q. Index

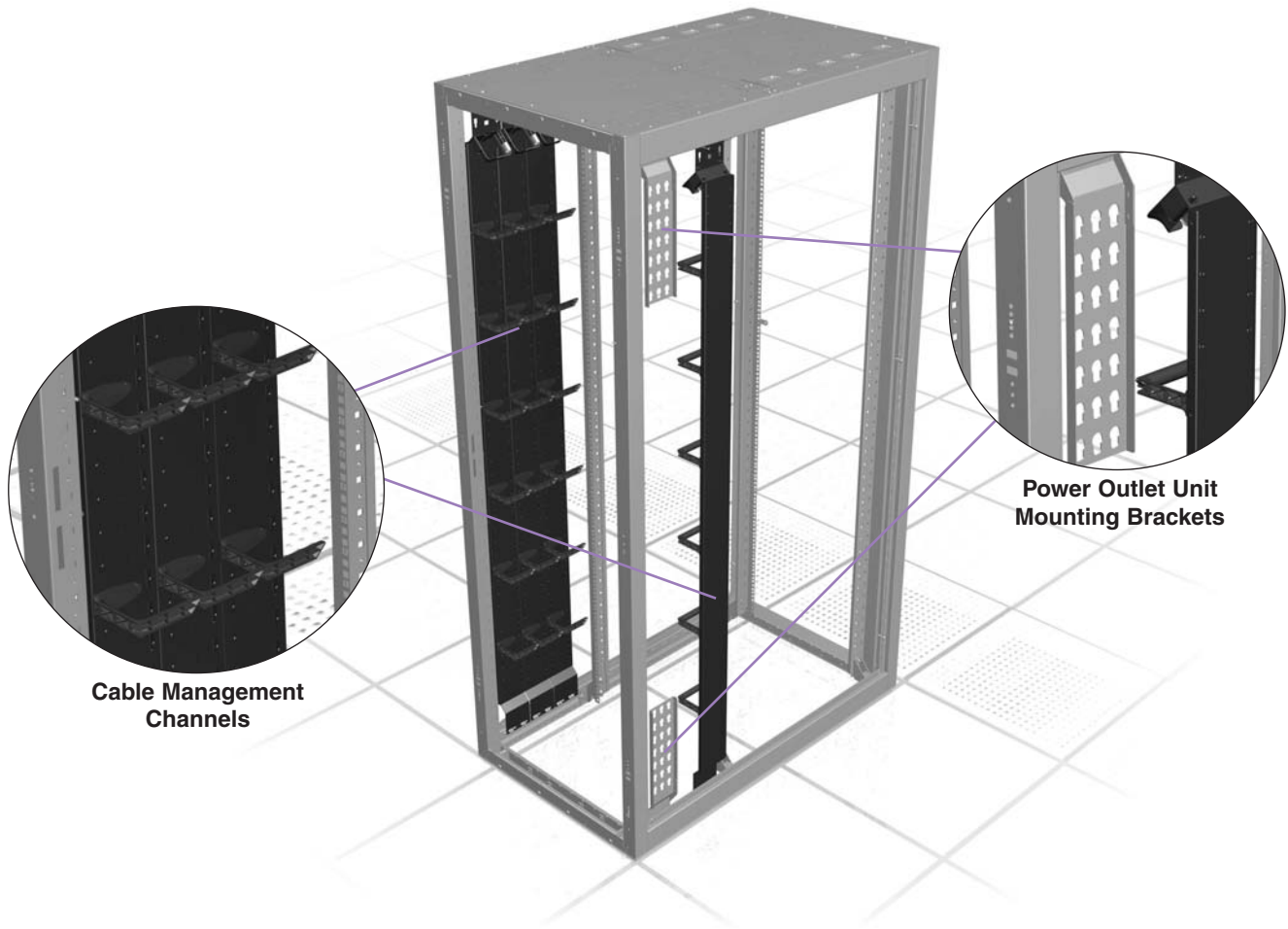

High Density Cable Management Configuration

- Cabinet supplied with four cable management channels and L-rings



Part Number	Part Description	Width		Height		No. of Rack Spaces	Std. Pkg. Qty.
		In.	mm	In.	mm		
S722C122H	Cabinet with full perforated front door. Split perforated rear door. Solid side panels.	28	700	78	1984	42	1
S752C122H	Cabinet with full perforated front door. Split perforated rear door. Solid side panels.	28	700	83	2118	45	1
S622C122H	Cabinet with full perforated front door. Split perforated rear door. Solid side panels.	24	600	78	1984	42	1
S652C122H	Cabinet with full perforated front door. Split perforated rear door. Solid side panels.	24	600	83	2118	45	1
S722C129H	Cabinet with full perforated front door. Split perforated rear door. No side panels.	28	700	78	1984	42	1
S752C129H	Cabinet with full perforated front door. Split perforated rear door. No side panels.	28	700	83	2118	45	1
S622C129H	Cabinet with full perforated front door. Split perforated rear door. No side panels.	24	600	78	1984	42	1
S652C129H	Cabinet with full perforated front door. Split perforated rear door. No side panels.	24	600	83	2118	45	1

White cabinets also available upon request. Please consult Panduit Customer Service for lead-times.

Configuration for Vertical Exhaust Duct and High Density Management

- Cabinet supplied with four cable management channels and L-Rings
- Directly vents network equipment exhaust into return plenum of data center
- Includes vertical blanking panels where appropriate and front and back floor seals



S722C131HV S722C131HVR
S752C131HV S752C131HVR
S622C131HV S622C131HVR
S652C131HV S652C131HVR

Part Number	Part Description	No. of Rack Spaces	Std. Pkg. Qty.
S722C131HV	Cabinet with full perforated front door. Solid rear door. Single side panel. Vertical exhaust duct extends cabinet 42" (1067mm) to 70" (1778mm).	42	1
S752C131HV	Cabinet with full perforated front door. Solid rear door. Single side panel. Vertical exhaust duct extends cabinet 42" (1067mm) to 70" (1778mm).	45	1
S622C131HV	Cabinet with full perforated front door. Solid rear door. Single side panel. Vertical exhaust duct extends cabinet 42" (1067mm) to 70" (1778mm).	42	1
S652C131HV	Cabinet with full perforated front door. Solid rear door. Single side panel. Vertical exhaust duct extends cabinet 42" (1067mm) to 70" (1778mm).	45	1
S722C131HVR	Cabinet with perforated single hinge front door. Solid single hinge back door. One side panel. Cage nut equipment rails mounted numbers up. Vertical exhaust duct not included.	42	1
S752C131HVR	Cabinet with perforated single hinge front door. Solid single hinge back door. One side panel. Cage nut equipment rails mounted numbers up. Vertical exhaust duct not included.	45	1
S622C131HVR	Cabinet with perforated single hinge front door. Solid single hinge back door. One side panel. Cage nut equipment rails mounted numbers up. Vertical exhaust duct not included.	42	1
S652C131HVR	Cabinet with perforated single hinge front door. Solid single hinge back door. One side panel. Cage nut equipment rails mounted numbers up. Vertical exhaust duct not included.	45	1

White cabinets also available upon request. Please consult Panduit Customer Service for lead-times.

Vertical Exhaust Ducting



Part Number	Part Description	Std. Pkg. Qty.
Vertical Exhaust Ducting for Net-SERV® Cabinets		
NSVED0611632BL	Vertical Exhaust Duct (VED) for 600mm Wide Net-SERV® Cabinet, height adjustable from 16.0" (406mm) up to 32.0" (813mm).	1
NSVED0711632BL	Vertical Exhaust Duct (VED) for 700mm Wide Net-SERV® Cabinet, height adjustable from 16.0" (406mm) up to 32.0" (813mm).	1
NSVED0613266BL	Vertical Exhaust Duct (VED) for 600mm Wide Net-SERV® Cabinet, height adjustable from 32.0" (813mm) up to 66.0" (1,676mm).	1
NSVED0713266BL	Vertical Exhaust Duct (VED) for 700mm Wide Net-SERV® Cabinet, height adjustable from 32.0" (813mm) up to 66.0" (1,676mm).	1
NSMOR07A4548BL	Net-SERV® Middle of Row Sealing Accessory, 45 RU x 48" Depth for 700mm Wide cabinet x 42 RU (cabinet to cabinet - w/o cabinet side panel).	1

Net-SERV® Doors and Floor Sealing Assemblies



Part Number	Part Description	Std. Pkg. Qty.
NSRDF06R0042BL	Net-SERV® Solid Rear Door and Floor Sealing Assembly for 600mm wide cabinet, 42 RU.	1
NSRDF07R0042BL	Net-SERV® Solid Rear Door and Floor Sealing Assembly for 700mm wide cabinet, 42 RU.	1
NSRDF06R0045BL	Net-SERV® Solid Rear Door and Floor Sealing Assembly for 600mm wide cabinet, 45 RU.	1
NSRDF07R0045BL	Net-SERV® Solid Rear Door and Floor Sealing Assembly for 700mm wide cabinet, 45 RU.	1

Net-SERV[®] Colocation Cabinet

Part Number	Part Description	No. of Rack Spaces	Std. Pkg. Qty.
Net-SERV[®] 700mm Wide, Split Colocation Cabinet			
S752S2C122B	Net-SERV [®] 700mm wide, 45 RU, Split Colo-Cabinet, with single perforated front door, split perforated rear doors, two side panels, and no cable management.	45	1

Net-SERV[®] Accessories

Part Number	Part Description	Std. Pkg. Qty.
Side Panels		
S22PS	42 RU removable solid side panel covers and protects cable and equipment. Single lock allows for quick release and removal of side panels for easier and faster moves, adds, and changes.	1
S52PS	45 RU removable solid side panel covers and protects cable and equipment. Single lock allows for quick release and removal of side panels for easier and faster moves, adds, and changes.	1

**S22PS
S52PS****S62RC
S72RC
S65RC
S75RC****SCSTR****SVPDUB****SVPPB****S62BRFK
S65BRFK
S72BRFK
S75BRFK**

Equipment Mounting Rails		
S62RC	42 RU x 600mm (24") wide cage nut equipment mounting rails, sold in pairs.	1
S72RC	42 RU x 700mm (28") wide cage nut equipment mounting rails, sold in pairs.	1
S65RC	45 RU x 600mm (24") wide cage nut equipment mounting rails, sold in pairs.	1
S75RC	45 RU x 700mm (28") wide cage nut equipment mounting rails, sold in pairs.	1

Castors		
SCSTR	Includes set of four castors.	1

Power Outlet Unit Mounting Brackets		
SVPDUB	Brackets for tool-less mounting of two 2" (51mm) widepower outlet units.	1

Vertical Patch Panel Mounting Bracket		
SVPPB	Net-SERV [®] Bracket to vertically mount 1 RU EIA 19" products including copper and fiber patch panels. Compatible with 700mm Net-SERV [®] Cabinets with finger bracket cable managers only.	1

Floor Seal Skirt for Net-SERV[®] Cabinets with Casters		
SRFS-KIT	Net-SERV [®] 48"/1200mm deep, End of Row Sealing Kit for Use with Casters to complete one side.	1

Finger Brackets for Net-SERV[®] Cabinets		
S62BRFK	Net-SERV [®] 24"/600 wide x 42 RU, cable management finger sections and bracket kit to complete two sides.	1
S65BRFK	Net-SERV [®] 24"/600 wide x 45 RU, cable management finger sections and bracket kit to complete two sides.	1
S72BRFK	Net-SERV [®] 28"/700 wide x 42 RU, cable management finger sections and bracket kit to complete two sides.	1
S75BRFK	Net-SERV [®] 28"/700 wide x 45 RU, cable management finger sections and bracket kit to complete two sides.	1

Net-SERV® Accessories (continued)



S62BRCK
S65BRCK
S72BRCK
S75BRCK



S65DS
S62DS
S75DS
S72DS



S65DSH
S62DSH
S75DSH
S72DSH

Part Number	Part Description	Std. Pkg. Qty.
High Density Cable Management Brackets for Net-SERV™ Cabinets		
S62BRCK	Net-SERV® 24"/600mm wide x 42 RU, vertical cable management L-Rings and bracket kit to complete one panel.	1
S65BRCK	Net-SERV® 24"/600mm wide x 45 RU, vertical cable management L-Rings and bracket kit to complete one panel.	1
S72BRCK	Net-SERV® 28"/700mm wide x 42 RU, vertical cable management L-Rings and bracket kit to complete one panel.	1
S75BRCK	Net-SERV® 28"/700mm wide x 45 RU, vertical cable management L-Rings and bracket kit to complete one panel.	1
Perforated Net-SERV® Doors		
S65DS	Rear perforated split door for Net-SERV® 600mm wide, 45 RU Cabinet.	1
S65DSH	Single hinge perforated door for Net-SERV® 600mm wide, 45 RU Cabinet.	1
S62DS	Rear perforated split door for Net-SERV® 600mm wide, 42 RU Cabinet.	1
S62DSH	Single hinge perforated door for Net-SERV® 600mm wide, 42 RU Cabinet.	1
S75DS	Rear perforated split door for Net-SERV® 700mm wide, 45 RU Cabinet.	1
S75DSH	Single hinge perforated door for Net-SERV® 700mm wide, 45 RU Cabinet.	1
S72DS	Rear perforated split door for Net-SERV® 700mm wide, 42 RU Cabinet.	1
S72DSH	Single hinge perforated door for Net-SERV® 700mm wide, 42 RU Cabinet.	1

A.
System
Overview

B.
Copper
Systems

C.
Fiber
Optic
Systems

D.
Power
over
Ethernet

E.
Zone
Cabling

F.
Wireless

G.
Outlets

H.
Media
Distribution

I.
Physical
Infrastructure
Management

J.
Overhead &
Underfloor
Routing

K.
Surface
Raceway

L.
Cabinets,
Racks &
Cable
Management

M.
Grounding &
Bonding

N.
Industrial

O.
Labeling &
Identification

P.
Cable
Management
Accessories

Q.
Index

Top of Cabinet Air Sealing Accessories

Designed for the Net-Access™ and Net-SERV® Cabinets, innovative air sealing accessories prevent cooling air from escaping through cable inlets improving thermal efficiency of the cabinets. Air sealing accessories snap into the cabinet top knock-outs for fast configuration.

600 mm (24") Net-SERV® Cabinet shown with optional vertical exhaust duct.

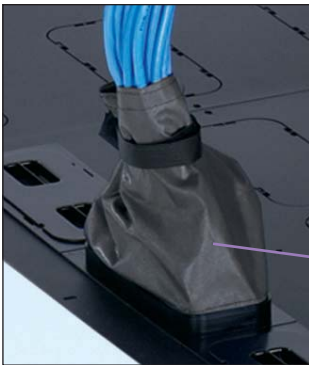

Cool Boot® Cabinet Top Air Sealing Fitting is used to seal copper data cables entering the cabinet.

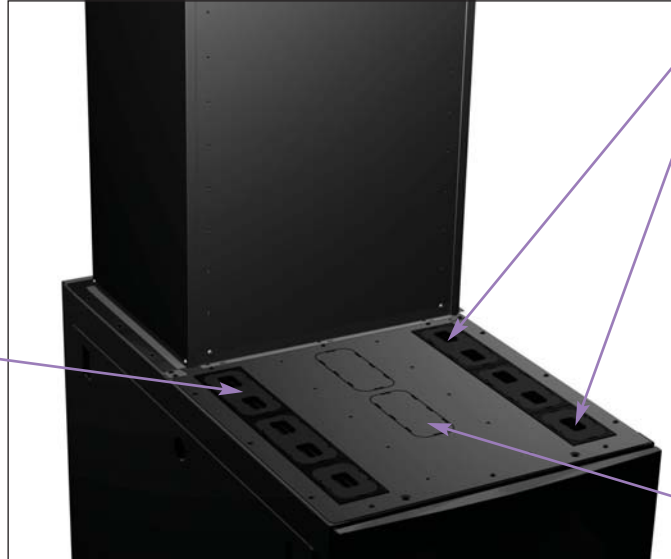

Net-SERV® Cabinets are provided with four pre-installed 3"x 8" and two 3"x 5" cabinet top covers and cable protection bezels.



Cabinet Top Air Sealing Fiber Optic Fitting is used to provide a transition and seal for fiber optic cables entering the cabinet via slit corrugated tubing.



Cabinet Top Cover and Cable Protection Bezel are used when additional knock-outs are removed from the cabinet.



Part Number	Part Description	Std. Pkg. Qty.
Cool Boot® Cabinet Top Air Sealing Fitting		
CTG3X8	Used to seal off 3" x 8" cabinet top openings when cables are routed through the top of a cabinet. Airtight fabric and Ultra-Cinch™ Tie closes top of fabric, minimizing hot air bypass around cables to improve cooling of network equipment and reduce energy costs. For use with both Net-SERV® and Net-Access™ Cabinets. Requires cabinet top cable protection bezel to be installed.	1
Cabinet Top Air Sealing Fiber Optic Fitting		
CTIDT15	Used to transition 1.5" (38mm) diameter slit corrugated tubing directly into a 3" x 8" or 3" x 5" cabinet top opening. Split design allows easy access to add or remove cables. Fitting minimizes hot air bypass around tubing to improve cooling of network equipment and reduce energy costs. For use with both Net-SERV® and Net-Access™ Cabinets. Requires cabinet top cable protection bezel to be installed.	1
Cabinet Top Cover and Cable Protection Bezel		
CTCC3X8	Used to seal off 3" x 8" cabinet top openings after knock-outs are removed. Can also be used to add the CTG3X8 or CTIDT15 to openings where knock-out has been removed. For use with both Net-SERV® and Net-Access™ Cabinets.	1
Slit Corrugated Loom Tubing		
CLT150F-X3*	Provides a vertical pathway as cables transfer from the FiberRunner® Fitting to the equipment below. Inside diameter is 1.48" (37.6mm) and outside diameter 1.73" (43.9mm). Sold in 10' rolls.	1

*For other colors replace suffix X3 (Orange) with X4 (Yellow) or X20 (Black).

Power and Environmental Management

Panduit Power Outlet Units (POUs) safely and efficiently manage and distribute power to allow multiple pieces of equipment to share a single power connector to enhance scalability of network build outs. Mounting flexibility allows quick and easy installation, and when used with Panduit® Net-Access™ and Net-SERV® Cabinets, the user receives a complete networking solution that will satisfy data center requirements today and into the future.

Basic and Metered Power Outlet Units

- Mounting brackets and screws included
- Integrated local power monitor display
- Power on indicator – green LED
- Scrolling power meter
- Surge protection

Power Strip Options Single Phase 15, 20, 30, and 60 AMPS



CMRPSH15

Part Number	Part Description	Std. Pkg. Qty.
Horizontal 15 AMP, Single Phase 120V		
CMRPSH15	Horizontal power strip 15 A, 120V, ten NEMA 5-15R receptacles, one 15 A thermal breaker, 10' power cord with NEMA 5-15P plug. UL and c-UL Listed. Dimensions: 1.7"H x 19.0"W x 3.8"D (44mm x 483mm x 95mm)	1
Horizontal 15 Amp with Surge Protection 120V		
CMRPSH15S	Horizontal power strip with a 15 A, 120V, 10 NEMA 5-15R receptacles, one 15 A thermal breaker, surge suppression indicator, and 10' power cord with NEMA 5-15P plug. UL and c-UL Listed. Dimensions: 1.7"H x 17.0"W x 3.8"D (44mm x 431mm x 95mm)	1
Vertical 15 AMP with Surge Protection 120V		
CMRPSV15SIL	Vertical power strip with a 15 A, 120V, 20 NEMA 5-15R in-line receptacles, one 15 A thermal breaker, red LED surge suppression indicator, and 10' power cord with NEMA 5-15P plug. UL and c-UL Listed. Dimensions: 66.3"H x 1.9"W x 1.6"D (1683mm x 47mm x 33mm)	1
CMRPSV15SILM	Vertical power strip with a 15 A, 120V, 20 NEMA 5-15R in-line receptacles, one 15 A thermal breaker, red LED surge suppression indicator, red LED current monitor, and 10' power cord with NEMA 5-15P plug. UL and c-UL Listed. Dimensions: 66.3"H x 1.6"W x 1.3"D (1683mm x 42mm x 34mm)	1
Horizontal 20 AMP, Single Phase 120V		
CMRPSH20*	Horizontal power strip 20 A, 120V, ten NEMA 5-20R receptacles, one 20 A thermal breaker, 10' power cord with NEMA 5-20P plug. UL and c-UL Listed. Dimensions: 1.7"H x 19.0"W x 3.8"D (44mm x 483mm x 95mm)	1
Horizontal 20 AMP with Surge Digital Monitor 120V		
CMRPSH20S	Horizontal power strip with a 20 A, 120V, 10 NEMA 5-20R receptacles, one 20 A thermal breaker, surge suppression indicator, and 10' power cord with NEMA 5-20P plug. UL and c-UL Listed. Dimensions: 1.7"H x 17.0"W x 3.8"D (44mm x 431mm x 95mm)	1
CMRPSH20STL	Horizontal power strip with a 20 A, 120V, 10 NEMA 5-20R receptacles, one 20 A thermal breaker, red LED surge suppression indicator, and 10' power cord with NEMA L5-20P twist lock plug. UL and c-UL Listed. Dimensions: 1.7"H x 17.0"W x 3.8"D (44mm x 431mm x 95mm)	1
Horizontal 20 AMP with Surge and Digital Monitor 120V		
CMRPSH20SMTL	Horizontal power strip with a 20 A, 120V, 10 NEMA 5-20R receptacles, one 20 A thermal breaker, red LED surge suppression indicator, red LED current monitor, and 10' power cord with NEMA L5-20P twist lock plug. UL and c-UL Listed. Dimensions: 1.7"H x 17.0"W x 3.8"D (44mm x 431mm x 95mm)	1

*For local digital monitor add "CM".

Refer to www.panduit.com for detailed information on the complete line of power outlet units.

Table continues on page L.36

Basic and Metered Power Outlet Units (continued)

Part Number	Part Description	Std. Pkg. Qty.
Horizontal 20 AMP with and without Digital Monitor 208V		
HB0B1E1BN12H1	Horizontal power strip with a 20 A, 208V, 12 NEMA 6-20R receptacles, one 20 A double pole magnetic breaker/on-off switch with integral switch guard, and 10' power cord with NEMA 6-20P plug. UL and c-UL Listed. Dimensions: 1.7"H x 17.0"W x 6.5"D (44mm x 431mm x 165mm)	1
HB0B1F1BN12H1	Horizontal power strip with a 20 A, 208V, 12 NEMA 6-20R receptacles, one 20 A double pole magnetic breaker/on-off switch with integral switch guard, and 10' power cord with NEMA L6-20P twist lock plug. UL and c-UL Listed. Dimensions: 1.7"H x 17.0"W x 6.5"D (43mm x 431mm x 165mm)	1
HB1B1E1BN12H1	Horizontal power strip with a 20 A, 208V, 12 NEMA 6-20R receptacles, one 20 A double pole magnetic breaker/on-off switch with integral switch guard, red LED current monitor, and 10' power cord with NEMA 6-20P plug. UL and c-UL Listed. Dimensions: 1.7"H x 17.0"W x 6.5"D (44mm x 431mm x 165mm)	1
HB1B1F1BN12H1	Horizontal power strip with a 20 A, 208V, 12 NEMA 6-20R receptacles, one 20 A double pole magnetic breaker/on-off switch with integral switch guard, red LED current monitor, and 10' power cord with NEMA L6-20P twist lock plug. UL and c-UL Listed. Dimensions: 1.7"H x 17"W x 6.5"D (44mm x 431mm x 165mm)	1
HB1B1E0BA08W1	Horizontal power strip with a 20 A, 208V, 4 IEC C-13 and 4 IEC C-19 receptacles, red LED current monitor, and 10' power cord with NEMA 6-20P plug. UL and c-UL Listed. Dimensions: 1.7"H x 17.0"W x 1.85"D (43mm x 431mm x 47mm)	1
HB1B1F0BA08W1	Horizontal power strip with a 20 A, 208V, 4 IEC C-13 and 4 IEC C-19 receptacles, red LED current monitor and 10' power cord with NEMA L6-20P twist lock plug. UL and c-UL Listed. Dimensions: 1.7"H x 17.0"W x 1.85"D (43mm x 431mm x 47mm)	1
HB0B1E0BA08W1	Horizontal power strip with a 20 A, 208V, 4 IEC C-13 and 4 IEC C-19 receptacles and 10' power cord with NEMA 6-20P plug. UL and c-UL Listed. Dimensions: 1.7"H x 17.0"W x 1.85"D (43mm x 431mm x 47mm)	1
HB0B1F0BA08W1	Horizontal power strip with a 20 A, 208V, 4 IEC C-13 and 4 IEC C-19 receptacles and 10' power cord with NEMA L6-20P twist lock plug. UL and c-UL Listed. Dimensions: 1.7"H x 17.0"W x 1.85"D (43mm x 431mm x 47mm)	1
2 RU Horizontal 20 AMP Straight Plug 208V without Power Meter		
HB0B1E0BA06J1	Horizontal power strip with a 20 A, 208V, 6 NEMA L6-20R receptacles and 10' power cord with NEMA 6-20P plug. UL and c-UL Listed. Dimensions: 3.4"H x 17.0"W x 6.0"D (86mm x 431mm x 155mm)	1
HB1B1E0BA06J1	Horizontal power strip with a 20 A, 208V, 6 NEMA L6-20R receptacles, red LED current monitor, and 10' power cord with NEMA 6-20P plug. UL and c-UL Listed. Dimensions: 3.4"H x 17.0"W x 6.0"D (86mm x 431mm x 155mm)	1
2 RU Horizontal 20 AMP Twist Lock Plug 208V with Power Meter		
HB1B1F0BA06J1	Horizontal power strip with a 20 A, 208V, 6 NEMA L6-20R receptacles, red LED current monitor, and 10' power cord with NEMA L6-20P twist lock plug. UL and c-UL Listed. Dimensions: 3.4"H x 17.0"W x 6.0"D (86mm x 431mm x 155mm)	1
HB0B1F0BA06J1	Horizontal power strip with a 20 A, 208V, 6 NEMA L6-20R receptacles and 10' power cord with NEMA L6-20P twist lock plug. UL and c-UL Listed. Dimensions: 3.4"H x 17.0"W x 6.0"D (86mm x 431mm x 155mm)	1

**For twist lock version replace 1E with 1F.

‡For non-metered versions, replace HB1 with HB0, i.e. HB0B1F0BA08W1.

Refer to www.panduit.com for detailed information on the complete line of power outlet units.

Basic and Metered Power Outlet Units (continued)



CMRPSV20

Part Number	Part Description	St. Pkg. Qty.
Vertical 20 AMP, Single Phase 120V		
CMRPSV20**	Vertical power strip with a 20 A, 120V, ten NEMA 5-20R receptacles, one 20 A thermal breaker, 10' power cord with NEMA 5-20P plug. UL and c-UL Listed. Dimensions: 38.5"H x 1.9"W x 1.3"D (978mm x 47mm x 33mm)	1
CMRPSVD20**	Vertical power strip with dual 20 A, 120V circuits, ten NEMA 5-20R receptacles per circuit, two 20 A thermal breakers, two 15' power cords with NEMA 5-20P plugs. UL and c-UL Listed. Dimensions: 66.3"H x 1.9"W x 1.3"D (1683mm x 47mm x 33mm)	1
Vertical 20 AMP with Surge Protection and in-line Receptacles 120V		
CMRPSV20SIL	Vertical power strip with a 20 A, 120V, 20 NEMA 5-20R in-line receptacles, one 20 A thermal breaker, red LED surge suppression indicator, and 10' power cord with NEMA 5-20P plug. UL and c-UL Listed. Dimensions: 66.3"H x 1.9"W x 1.6"D (1683mm x 47mm x 33mm)	1
CMRPSV20SILT	Vertical power strip with a 20 A, 120V, 20 NEMA 5-20R in-line receptacles, one 20 A thermal breaker, red LED surge suppression indicator, and 10' power cord with NEMA L5-20P twist lock plug. UL and c-UL Listed. Dimensions: 66.3"H x 1.9"W x 1.6"D (1683mm x 47mm x 33mm)	1
CMRPSV20SILM	Vertical power strip with a 20 A, 120V, 20 NEMA 5-20R in-line receptacles, one 20 A thermal breaker, red LED surge suppression indicator, red LED current monitor, and 10' power cord with NEMA 5-20P plug. UL and c-UL Listed. Dimensions: 66.3"H x 1.9"W x 1.6"D (1683mm x 47mm x 33mm)	1
CMRPSV20SILTLM	Vertical power strip with a 20 A, 120V, 20 NEMA 5-20R in-line receptacles, one 20 A thermal breaker, red LED surge suppression indicator, red LED current monitor, and 10' power cord with NEMA L5-20P twist lock plug. UL and c-UL Listed. Dimensions: 66.3"H x 1.9"W x 1.6"D (1683mm x 47mm x 33mm)	1
Vertical 20 AMP with Surge Protection and without Digital Monitor 120V		
CMRPSV20S	Vertical power strip with a 20 A, 120V, twenty NEMA 5-20R duplex receptacles, one 20 A thermal breaker, red LED surge suppression indicator, and 10' power cord with NEMA 5-20P plug. UL and c-UL Listed. Dimensions: 66.3"H x 1.9"W x 1.3"D (1683mm x 47mm x 33mm)	1
CMRPSV20STL	Vertical power strip with a 20 A, 120V, twenty NEMA 5-20R duplex receptacles, one 20 A thermal breaker, red LED surge suppression indicator, and 10' power cord with NEMA L5-20P twist lock plug. UL and c-UL Listed. Dimensions: 66.3"H x 1.9"W x 1.3"D (1683mm x 47mm x 33mm)	1
CMRPSV20SM	Vertical power strip with a 20 A, 120V, twenty NEMA 5-20R duplex receptacles, one 20 A thermal breaker, red LED surge suppression indicator, red LED current monitor, and 10' power cord with NEMA 5-20P plug. UL and c-UL Listed. Dimensions: 66.3"H x 1.9"W x 1.3"D (1683mm x 47mm x 33mm)	1
CMRPSV20STLM	Vertical power strip with a 20 A, 120V, twenty NEMA 5-20R duplex receptacles, one 20 A thermal breaker, red LED surge suppression indicator, red LED current monitor, and 10' power cord with NEMA L5-20P twist lock plug. UL and c-UL Listed. Dimensions: 66.3"H x 1.9"W x 1.3"D (1683mm x 47mm x 33mm)	1
CMRPSV20C139	Vertical power strip with 20 A, 120V, 24 IEC C-13 and 6 IEC C-19 receptacles, and 10' power cords with NEMA 5-20P plug. UL and c-UL Listed. Dimensions: 66.3"H x 2.0"W x 2.0"D (1683mm x 51mm x 51mm)	1
CMRPSV20C139TL	Vertical power strip with a 20 A, 120V, 24 IEC C-13 and 6 IEC C-19 receptacles, and 10' power cords with NEMA L5-20P twist lock plugs. UL and c-UL Listed. Dimensions: 66.3"H x 2.0"W x 2.0"D (1683mm x 51mm x 51mm)	1

**For Twist Lock Plug add "TL".

Refer to www.panduit.com for detailed information on the complete line of power outlet units.

Table continues on page L.38



VB0B1E0CA20H1



VB0A1J0BA24E1

Basic and Metered Power Outlet Units (continued)

Part Number	Part Description	Std. Pkg. Qty.
Vertical 20 AMP Dual Plug with and without Digital Monitor 208V		
VB0B1E0CA20H1	Vertical power strip with dual 20 A, 208V, ten NEMA 6-20R receptacles per circuit, two 10' power cords with NEMA 6-20P plugs. UL and c-UL Listed. Dimensions: 66.3"H x 1.9"W x 1.3"D (1683mm x 47mm x 33mm)	1
VB0B1F0CA20H1	Vertical power strip with dual 20 A, 208V, ten NEMA 6-20R receptacles per circuit, red LED current monitor and two 10' power cords with NEMA L6-20P twist lock plugs. UL and c-UL Listed. Dimensions: 66.3"H x 1.9"W x 1.3"D (1683mm x 47mm x 33mm)	1
VB1B1E0CA20H1	Vertical power strip with dual 20 A, 208V ten NEMA 6-20R receptacles per circuit, red LED current monitor per circuit, and two 10' power cords with NEMA 6-20P plugs. UL and c-UL Listed. Dimensions: 66.3"H x 1.9"W x 1.3"D (1683mm x 47mm x 33mm)	1
VB1B1F0CA20H1	Vertical power strip with dual 20 A, 208V ten NEMA 6-20R receptacles per circuit, red LED current monitor per circuit, and two 10' power cords with NEMA L6-20P twist lock plugs. UL and c-UL Listed. Dimensions: 66.3"H x 1.9"W x 1.3"D (1683mm x 47mm x 33mm)	1
Vertical 20 AMP 3 Phase 120V		
VB0A1J0BA24E1	Vertical power strip with a 20 A WYE, 120 V, 24 NEMA 5-20R receptacles and 10' power cord with NEMA L21-20P twist lock plug. UL and c-UL Listed. Dimensions: 66.3"H x 2.0"W x 2.0"D (1683mm x 51mm x 51mm)	1
VB1A1J0BA24E1	Vertical power strip with a 20 A WYE, 120V, 24 NEMA 5-20R receptacles, and 10' power cord with NEMA L21-20P twist lock plug. UL and c-UL Listed. Dimensions: 66.3"H x 2.0"W x 2.0"D (1683mm x 51mm x 51mm)	1
Vertical 20 AMP 3 Phase 120V		
VB0A1J0BA30P1	Vertical power strip with 20 A WYE, 120 V 24 IEC C-13 and 6 IEC C-19 receptacles and 10' power cord with NEMA L21-20P twist lock plug. UL and c-UL Listed. Dimensions: 66.3"H x 2.0"W x 2.0"D (1683mm x 51mm x 51mm)	1
VB1A1J0BA30P1	Vertical power strip with 20 A WYE, 120V, 24 IEC C-13 and 6 IEC C-19 receptacles, red LED current monitor, and 10' power cord with NEMA L21-20P twist lock plug. UL and c-UL Listed. Dimensions: 66.3"H x 2.0"W x 2.0"D (1683mm x 51mm x 51mm)	1
Vertical 20 AMP 3 Phase 208V		
VB0B1J0BA24H1	Vertical power strip with a 20 A WYE, 208V, 24 NEMA 6-20R receptacles and 10' power cord with NEMA 21-20P twist lock plug. UL and c-UL Listed. Dimensions: 66.3"H x 2.0"W x 2.0"D (1683mm x 51mm x 51mm)	1
VB1B1J0BA24H1	Vertical power strip with a 20 A WYE, 208V, 24 NEMA 6-20R receptacles, red LED current monitor, and 10' power cord with NEMA L21-20P twist lock plug. UL and c-UL Listed. Dimensions: 66.3"H x 2.0"W x 2.0"D (1683mm x 51mm x 51mm)	1

**For Twist Lock Plug add "TL".

Refer to www.panduit.com for detailed information on the complete line of power outlet units.

Basic and Metered Power Outlet Units (continued)



VB0C1J0BA30U1

Part Number	Part Description	Std. Pkg. Qty.
Vertical 20 AMP 3 Phase 208V		
VB1B1J0BA30P1	Vertical power strip with 20 A WYE, 208V, 24 IEC C-13 and 6 IEC C-19 receptacles, red LED current monitor, and 10' power cord with NEMA L21-20P twist lock plug. UL and c-UL Listed. Dimensions: 66.3"H x 2.0"W x 2.0"D (1683mm x 51mm x 51mm)	1
VB0C1J0BA30U1	Vertical power strip with a 20 A WYE, 208V, 24 NEMA 5-20R and 6 NEMA L6-20R receptacles and 10' power cord with NEMA L21-20P twist lock plug. UL and c-UL Listed. Dimensions: 66.3"H x 2.0"W x 2.0"D (1683mm x 51mm x 51mm)	1
VB1C1J0BA30U1	Vertical power strip with a 20 A WYE, 208V, 24 NEMA 5-20R and 6 NEMA L6-20R receptacles, red LED current monitor, and 10' power cord with NEMA L21-20P twist lock plug. UL and c-UL Listed. Dimensions: 66.3"H x 2.0"W x 2.0"D (1683mm x 51mm x 51mm)	1
VB0C1J0BA18V1	Vertical power strip with a 20 A WYE, 208V, 12 IEC C-13 and 6 NEMA 5-20R receptacles and 10' power cord with NEMA L21-20P twist lock plug. UL and c-UL Listed. Dimensions: 70.0"H x 2.0"W x 2.0"D (1778mm x 51mm x 51mm)	1
1 RU Horizontal 30 AMP with and without Digital Monitor 120V		
HB0A1M2BN12E1	Horizontal power strip 30 A, 120V, 12 NEMA 5-20R receptacles, two 20 A single pole magnetic breaker/on-off switch with integral switch guard, and 10' power cord with NEMA L5-30P twist lock plug. UL and c-UL Listed. Dimensions: 1.7"H x 17.0"W x 6.5"D (43mm x 431mm x 165mm)	1
HB1A1M2BN12E1	Horizontal power strip 30 A, 120V, 12 NEMA 5-20R receptacles, two 20 A single pole magnetic breaker/on-off switch with integral switch guard, LED current monitor, and 10' power cord with NEMA L5-30P twist lock plug. UL and c-UL Listed. Dimensions: 1.7"H x 17.0"W x 6.5"D (43mm x 431mm x 165mm)	1
HB0A1M2BT08W1	Horizontal power strip 30 A, 120V, 4 IEC C-13 and 4 IEC C-19 receptacles, two 15 A thermal breakers, and 10' power cord with NEMA L5-30P twist lock plug. UL and c-UL Listed. Dimensions: 1.7"H x 17.0"W x 1.85"D (43mm x 431mm x 47mm)	1
HB1A1M2BT08W1	Horizontal power strip 30 A, 120V, 4 IEC C-13 and 4 IEC C-19 receptacles, two 15 A thermal breakers, red LED current monitor, and 10' power cord with NEMA L5-30P twist lock plug. UL and c-UL Listed. Dimensions: 1.7"H x 17.0"W x 1.85"D (43mm x 431mm x 47mm)	1
HB0A1M2BT10M1	Horizontal power strip 30 A, 120V, 10 IEC C-13 receptacles, two 15 A thermal breakers and 10' power cord with NEMA L5-30P twist lock plug. UL and c-UL Listed. Dimensions: 1.7"H x 17.0"W x 1.6"D (43mm x 431mm x 41mm)	1
HB1A1M2BT10M1	Horizontal power strip 30 A, 120V, 10 IEC C-13 receptacles, two 15 A thermal breakers, red LED current monitor, and 10' power cord with NEMA L5-30P twist lock plug. UL and c-UL Listed. Dimensions: 1.7"H x 17.0"W x 1.6"D (43mm x 431mm x 41mm)	1

**For Twist Lock Plug add "TL".

Refer to www.panduit.com for detailed information on the complete line of power outlet units.

Table continues on page L.40

Basic and Metered Power Outlet Units (continued)

Part Number	Part Description	Std. Pkg. Qty.
2 RU Horizontal 30 AMP with and without Digital Monitor 120V		
HB0A1M2BN06G1	Horizontal power strip 30 A, 120V, 6 NEMA L5-20R receptacles, two 20 A double pole magnetic breaker/on-off switch with integral switch guard, and 10' power cord with NEMA L5-30P twist lock plug. UL and c-UL Listed. Dimensions: 3.4"H x 17.0"W x 6.0"D (86mm x 431mm x 152mm)	1
HB1A1M2BN06G1	Horizontal power strip 30 A, 120V, 6 NEMA L5-20R receptacles, two 20 A double pole magnetic breaker/on-off switch with integral switch guard, red LED current monitor, and 10' power cord with NEMA L5-30P twist lock plug. UL and c-UL Listed. Dimensions: 3.4"H x 17.0"W x 6.0"D (86mm x 431mm x 152mm)	1
HB0A1M0BA06K1	Horizontal power strip 30 A, 120V, 6 NEMA L5-30R receptacles, and 10' power cord with NEMA L5-30P twist lock plug. UL and c-UL Listed. Dimensions: 3.4"H x 17.0"W x 6.0"D (86mm x 431mm x 152mm)	1
HB1A1M0BA06K1	Horizontal power strip with a 30 A, 120V, 6 NEMA L5-30R receptacles, red LED current monitor, and 10' power cord with NEMA L5-30P twist lock plug. UL and c-UL Listed. Dimensions: 3.4"H x 17.0"W x 6.0"D (86mm x 431mm x 152mm)	1
1 RU Horizontal 30 AMP with and without Digital Monitor 208V		
HB0B1L4BT10M1	Horizontal power strip 30 A, 208V, 10 IEC C-13 receptacles, four 15 A thermal breakers, and 10' power cord with NEMA L6-30P twist lock plug. UL and c-UL Listed. Dimensions: 1.7"H x 17.0"W x 1.6"D (43mm x 431mm x 41mm)	1
HB1B1L4BT10M1	Horizontal power strip 30 A, 208V, 10 IEC C-13 receptacles, four 15 A thermal breakers, red LED current monitor, and 10' power cord with NEMA L6-30P twist lock plug. UL and c-UL Listed. Dimensions: 1.7"H x 17.0"W x 1.6"D (43mm x 431mm x 41mm)	1
HB0B1L2BN12H1	Horizontal power strip 30 A, 208V, 12 NEMA 6-20R receptacles, two 20 A double pole magnetic breaker/on-off switch with integral guard, and 10' power cord with NEMA L6-30P twist lock plug. UL and c-UL Listed. Dimensions: 1.7"H x 17.0"W x 6.5"D (43mm x 431mm x 165mm)	1
HB1B1L2BN12H1	Horizontal power strip 30 A, 208V, 12 NEMA 6-20R receptacles, two 20 A double pole magnetic breaker/on-off switch with integral guard, red LED current monitor, and 10' power cord with NEMA L6-30P twist lock plug. UL and c-UL Listed. Dimensions: 1.7"H x 17.0"W x 6.5"D (43mm x 431mm x 165mm)	1
HB0B1L4BT08W1	Horizontal power strip 30 A, 208V, 4 IEC C-13 and 4 IEC C-19 receptacles, four 15 A thermal breakers and 10' power cord with NEMA L6-30P twist lock plug. UL and c-UL Listed. Dimensions: 1.7"H x 17.0"W x 1.85"D (43mm x 431mm x 47mm)	1
HB1B1L4BT08W1	Horizontal power strip 30 A, 208V, 4 IEC C-13 and 4 IEC C-19 receptacles, four 15 A thermal breakers, red LED current monitor, and 10' power cord with NEMA L6-30P twist lock plug. UL and c-UL Listed. Dimensions: 1.7"H x 17.0"W x 1.85"D (43mm x 431mm x 47mm)	1

**For twist lock version replace 1E with 1F.

‡For non-metered versions, replace HB1 with HB0, i.e. HB0B1F0BA08W1.

Refer to www.panduit.com for detailed information on the complete line of power outlet units.

Basic and Metered Power Outlet Units (continued)

Part Number	Part Description	Std. Pkg. Qty.
2 RU Horizontal 30 AMP with and without Digital Monitor 208V		
HB0B1L2BN06J1	Horizontal power strip with a 30 A, 208V, 6 NEMA L6-20R receptacles, two 20 A double pole magnetic breaker/on-off switch with integral switch guard, and 10' power cord with NEMA L6-30P twist lock plug. UL and c-UL Listed. Dimensions: 3.4"H x 17.0"W x 6.0"D (86mm x 431mm x 152mm)	1
HB1B1L2BN06J1	Horizontal power strip with a 30 A, 208V, 6 NEMA L6-20R receptacles, two 20 A double pole magnetic breaker/on-off switch with integral switch guard, red LED current monitor, and 10' power cord with NEMA L6-30P twist lock plug. UL and c-UL Listed. Dimensions: 3.4"H x 17.0"W x 6.0"D (86mm x 431mm x 152mm)	1
HB0B1L0BA06L1	Horizontal power strip with a 30 A, 208V, 6 NEMA L6-30R receptacles, and 10' power cord with NEMA L6-30P twist lock plug. UL and c-UL Listed. Dimensions: 3.4"H x 17.0"W x 6.0"D (86mm x 431mm x 152mm)	1
HB1B1L0BA06L1	Horizontal power strip with a 30 A, 208 V, 6 NEMA L6-30R receptacles, red LED current monitor, and 10' power cord with NEMA L6-30P twist lock plug. UL and c-UL Listed. Dimensions: 3.4"H x 17.0"W x 6.0"D (86mm x 431mm x 152mm)	1
Vertical 30 AMP with and without Digital Monitor 120V		
VB0A1M2BM30P1	Vertical power strip 30 A, 120V, 24 IEC C-13 and 6 IEC C-19 receptacles, two 20 A single pole magnetic breaker/on-off switch with integral switch guard, and 10' power cord with NEMA L5-30P twist lock plug. UL and c-UL Listed. Dimensions: 66.3"H x 2.0"W x 2.0"D Breaker Doghouse add 1.44" (87.4mm) to overall depth (1683mm x 51mm x 51mm)	1
VB1A1M2BM30P1	Vertical power strip 30 A, 120V, 24 IEC C-13 and 6 IEC C-19 receptacles, two 20 A single pole magnetic breaker/on-off switch with integral switch guard, red LED current monitor, and 10' power cord with NEMA L5-30P twist lock plug. UL and c-UL Listed. Dimensions: 66.3"H x 2.0"W x 2.0"D Breaker Doghouse add 1.44" (87.4mm) to overall depth (1683mm x 51mm x 51mm)	1
VB0A1M2BM24E1	Vertical power strip 30 A, 120 V, 24 NEMA 5-20R receptacles, two 20 A single pole magnetic breaker/on-off switch with integral switch guard, and 10' power cord with NEMA L5-30P twist lock plug. UL and c-UL Listed. Dimensions: 66.3"H x 2.0"W x 2.0"D Breaker Doghouse add 1.44" (87.4mm) to overall depth (1683mm x 51mm x 51mm)	1
VB1A1M2BM24E1	Vertical power strip with dual 30 A, 120V, 24 NEMA 5-20R receptacles, two 20 A single pole magnetic breaker/on-off switch with integral switch guard, red LED current monitor, and 10' power cord with NEMA L5-30P twist lock plug. UL and c-UL Listed. Dimensions: 66.3"H x 2.0"W x 2.0"D Breaker Doghouse add 1.44" (87.4mm) to overall depth (1683mm x 51mm x 51mm)	1
Vertical 30 AMP, Dual Plug with and without Digital Monitor 120V		
VB0A1M2CN24E1	Vertical power strip with dual 30 A, 120V twenty-four NEMA 5-20R receptacles per circuit, two 20 A double pole magnetic breaker/on-off switch with integral switch guard, and two 10' power cords with NEMA L5-30P twist lock plugs. UL and c-UL Listed. Dimensions: 66.3"H x 2.0"W x 2.0"D Breaker Doghouse add 1.44" (87.4mm) to overall depth (1683mm x 51mm x 51mm)	1
VB1A1M2CN24E1	Vertical power strip with dual 30 A, 120V twenty-four NEMA 5-20R receptacles per circuit, two 20 A double pole magnetic breaker/on-off switch with integral switch guard, red LED current monitor, and two 10' power cords with NEMA L5-30P twist lock plugs. UL and c-UL Listed. Dimensions: 66.3"H x 2.0"W x 2.0"D Breaker Doghouse add 1.44" (87.4mm) to overall depth (1683mm x 51mm x 51mm)	1
Vertical 30 AMP Dual Plug with and without Digital Monitor 208V		
VB1B1L4CN48M1	Vertical power strip 30 Amp, 208V, 48 IEC C-13 receptacles, four 20 Amp double pole magnetic breaker/on-off switch with integral switch guard, two red LED current monitors, and dual 10' power cord with NEMA L6-30P twist lock plugs. UL and c-UL Listed. Dimensions: 66.3"H x 3.5"W x 2.0"D Breaker Doghouse add 1.44" (87.4mm) to overall depth (1683mm x 89mm x 51mm).	1



VB0A1M2BM30P1



VB0A1P3BN24E1

**For Twist Lock Plug add "TL".

Refer to www.panduit.com for detailed information on the complete line of power outlet units.

Table continues on page L.42



VB1B1L2BN24H1

Basic and Metered Power Outlet Units (continued)

Part Number	Part Description	Std. Pkg. Qty.
Vertical 30 AMP with and without Digital Monitor 208V		
VB0B1L4BT24M1	Vertical power strip 30 A, 208V, 24 IEC C-13 receptacles, four 15 A thermal breakers, and 10' power cord with NEMA L6-30P twist lock plug. UL and c-UL Listed. Dimensions: 66.3"H x 1.7"W x 1.7"D Breaker Doghouse add 1.44" (87.4mm) to overall depth (1683mm x 44mm x 44mm)	1
VB1B1L4BT24M1	Vertical power strip 30 A, 208V, 24 IEC C-13 receptacles, four 15 A thermal breakers, red LED current monitor, and 10' power cord with NEMA L6-30P twist lock plug. UL and c-UL Listed. Dimensions: 66.3"H x 1.7"W x 1.7"D Breaker Doghouse add 1.44" (87.4mm) to overall depth (1683mm x 44mm x 44mm)	1
VB1B1L2BN24H1	Vertical power strip 30 A, 208V, 24 NEMA 6-20R receptacles, two 20 A double pole magnetic breaker/on-off switch with integral switch guard, red LED current monitor, and 10' power cord with NEMA L6-30P twist lock plug. UL and c-UL Listed. Dimensions: 66.3"H x 2.0"W x 2.0"D Breaker Doghouse add 1.44" (87.4mm) to overall depth (1683mm x 51mm x 51mm)	1
VB0B1L2BN12J1	Vertical power strip 30 A, 208V, 12 NEMA L6-20R receptacles, two 20 A double pole magnetic breaker/on-off switch with integral switch guard, and 10' power cord with NEMA L6-30P twist lock plug. UL and c-UL Listed. Dimensions: 66.3"H x 2.0"W x 2.0"D Breaker Doghouse add 1.44" (87.4mm) to overall depth (1683mm x 51mm x 51mm)	1
VB1B1L2BN12J1	Vertical power strip 30 A, 208V, 12 NEMA L6-20R receptacles, two 20 A double pole magnetic breaker/on-off switch with integral switch guard, red LED current monitor, and 10' power cord with NEMA L6-30P twist lock plug. UL and c-UL Listed. Dimensions: 66.3"H x 2.0"W x 2.0"D Breaker Doghouse add 1.44" (87.4mm) to overall depth (1683mm x 51mm x 51mm)	1
VB1B1L4CN48M1	Vertical power strip with 30 A, 208V, 48 IEC C-13 receptacles, four 20 A double pole magnetic breaker /on-off switch with integral switch guard, two red LED current monitors and dual 10' power cord with NEMA L6-30P twist lock plugs. UL and c-UL Listed. Dimensions: 66.3"H x 3.5"W x 2.0"D (1683mm x 89mm x 51mm)	1
Vertical 30 AMP, 3 Phase WYE 120V		
VB0A1P3BN24E1	Vertical power strip 30 A, 120V WYE, 24 NEMA 5-20R receptacles, three 20 A double pole magnetic breaker/on-off switch with integral switch guard, and 10' power cord with NEMA L21-30P twist lock plug. UL and c-UL Listed. Dimensions: 66.3"H x 2.0"W x 2.0"D Breaker Doghouse add 1.44" (87.4mm) to overall depth (1683mm x 51mm x 51mm)	1
VB1A1P3BN24E1‡	Vertical power strip 30 A, 120V, 24 NEMA 5-20R receptacles, three 20 A double pole magnetic breaker/on-off switch with integral switch guard, red LED current monitor, and 10' power cord with NEMA L21-30P twist lock plug. UL and c-UL Listed. Dimensions: 66.3"H x 2.0"W x 2.0"D Breaker Doghouse add 1.44" (87.4mm) to overall depth (1683mm x 51mm x 51mm)	1
VB1A1P3BN30P1‡	Vertical power strip 30 A, 120V WYE, 24 IEC C-13 and 6 IEC C-19 receptacles, three 20 A double pole magnetic breaker/on-off switch with integral switch guard, red LED current monitor, and 10' power cord with NEMA L21-30P twist lock plug. UL and c-UL Listed. Dimensions: 66.3"H x 2.0"W x 2.0"D Breaker Doghouse add 1.44" (87.4mm) to overall depth (1683mm x 51mm x 51mm)	1
VB1A1P3BN12G1‡	Vertical power strip 30 A, 120V WYE, 12 NEMA L5-20R receptacles, three 20 A double pole magnetic breaker/on-off switch with integral switch guard, red LED current monitor, and 10' power cord with NEMA L21-30P twist lock plug. UL and c-UL Listed. Dimensions: 66.3"H x 2.0"W x 2.0"D Breaker Doghouse add 1.44" (87.4mm) to overall depth (1683mm x 51mm x 51mm)	1

‡For non-metered versions, replace VB1 with VB0, i.e. VB0A1P3BN24E1

Refer to www.panduit.com for detailed information on the complete line of power outlet units.

Basic and Metered Power Outlet Units (continued)



Part Number	Part Description	Std. Pkg. Qty.
Vertical 30 AMP, 3 Phase WYE 208V		
VB1B1P3BN24H1‡	Vertical power strip 30 A, 208V WYE, 24 NEMA 6-20R receptacles, three 20 A double pole magnetic breaker/on-off switch with integral switch guard, red LED current monitor, and 10' power cord with NEMA L21-30P twist lock plug. UL and c-UL Listed. Dimensions: 66.3"H x 2.0"W x 2.0"D Breaker Doghouse add 1.44" (87.4mm) to overall depth (1683mm x 51mm x 51mm)	1
VB1B1P3BN12J1‡	Vertical power strip 30 A, 208V WYE, 12 NEMA L6-20R receptacles, three 20 A double pole magnetic breaker/on-off switch with integral switch guard, red LED current monitor, and 10' power cord with NEMA L21-30P twist lock plug. UL and c-UL Listed. Dimensions: 66.3"H x 2.0"W x 2.0"D Breaker Doghouse add 1.44" (87.4mm) to overall depth (1683mm x 51mm x 51mm)	1
VB1A1P3BN30P1‡	Vertical power strip 30 A, 120V WYE, 24 IEC C-13 and 6 IEC C-19 receptacles, three 20 A double pole magnetic breaker/on-off switch with integral switch guard, red LED current monitor, and 10' power cord with NEMA L21-30P twist lock plug. UL and c-UL Listed. Dimensions: 66.3"H x 2.0"W x 2.0"D Breaker Doghouse add 1.44" (87.4mm) to overall depth (1683mm x 51mm x 51mm)	1
Vertical 30 AMP, 3 Phase WYE 120/208V		
VB0C1P3BN33X1	Vertical power strip 30 A, 120/208V WYE, 24 IEC C-13 and 3 IEC C-19 and 6 NEMA 5-20R receptacles, three 20 A double pole magnetic breaker/on-off switch, with integral switch guard, and 10' power cord with NEMA L21-30P twist lock plug. UL and c-UL Listed. Dimensions: 66.3"H x 2.0"W x 2.0"D Breaker Doghouse add 1.44" (87.4mm) to overall depth (1683mm x 51mm x 51mm)	1
VB0C1P3BN24Y1	Vertical power strip 30 A, 120/208V WYE, 12 IEC C-13 and 6 IEC C-19 and 6 NEMA 5-20R, receptacles, three 20 A double pole magnetic breaker/on-off switch, with integral switch guard, and 10' power cord with NEMA L21-30P twist lock plug. UL and c-UL Listed. Dimensions: 70"H x 2.0"W x 2.0"D Breaker Doghouse add 1.44" (87.4mm) to overall depth (1777mm x 51mm x 51mm)	1
Vertical 30 AMP, 3 Phase WYE 230/400V		
VB1D1Q3BN30P1‡	Vertical power strip 30 A, 230/400V WYE, 24 IEC C-13 and 6 IEC C-19 receptacles, three 20 A double pole magnetic breaker/on-off switch with integral switch guard, red LED current monitor, and 10' power cord with NEMA L22-30P twist lock plug. UL and c-UL Listed. Dimensions: 66.3"H x 2.0"W x 2.0"D Breaker Doghouse add 1.44" (87.4mm) to overall depth (1683mm x 51mm x 51mm)	1
Vertical 30 AMP, 3 Phase Delta 208V		
VB1B1N3BN24H1‡	Vertical power strip 30 A, 208V Delta, 24 NEMA 6-20R receptacles, three 20 A double pole magnetic breaker/on-off switch with integral switch guard, red LED current monitor, and 10' power cord with NEMA L15-30P twist lock plug. UL and c-UL Listed. Dimensions: 66.3"H x 2.0"W x 2.0"D Breaker Doghouse add 1.44" (87.4mm) to overall depth (1683mm x 51mm x 51mm)	1
VB1B1N3BN12J1‡	Vertical power strip 30 A, 208V Delta, 12 NEMA L6-20R receptacles, three 20 A double pole magnetic breaker/on-off switch with integral switch guard, red LED current monitor, and 10' power cord with NEMA L15-30P twist lock plug. UL and c-UL Listed. Dimensions: 66.3"H x 2.0"W x 2.0"D Breaker Doghouse add 1.44" (87.4) to overall depth (1683mm x 51mm x 51mm)	1
VB1B1N3BN30P1‡	Vertical power strip 30 A, 208V Delta, 24 IEC C-13 and 6 IEC C-19 receptacles, three 20 A double pole magnetic breaker/on-off switch with integral switch guard, red LED current monitor, and 10' power cord with NEMA L15-30P twist lock plug. UL and c-UL Listed. Dimensions: 66.3"H x 2.0"W x 2.0"D Breaker Doghouse add 1.44" (87.4) to overall depth (1683mm x 51mm x 51mm)	1

‡For Twist Lock Plug add "TL".

Refer to www.panduit.com for detailed information on the complete line of power outlet units.

Table continues on page L.44

Basic and Metered Power Outlet Units (continued)

VB0B2C3BN30P1

Part Number	Part Description	Std. Pkg. Qty.
60 Amp with and without Digital Monitor 208V		
VB0B2C3BN30P1	Vertical power strip 60 A, 208V, 24 IEC C-13 and 6 IEC C-19 receptacles, three 20 A double pole magnetic breaker/on-off switch with integral switch guard, and 10' power cord with IEC 60309 – 2P+E pin in sleeve water tight connector. UL and c-UL Listed. Dimensions: 66.3"H x 2.0"W x 2.0"D Breaker Doghouse add 1.44" (87.4mm) to overall depth (1683mm x 51mm x 51mm)	1
VB1B2C3BN30P1	Vertical power strip 60 A, 208V, 24 IEC C-13 and 6 IEC C-19 receptacles, three 20 A double pole magnetic breaker/on-off switch with integral switch guard, red LED current monitor, and 10' power cord with IEC 60309 – 2P+E pin in sleeve water tight connector. UL and c-UL Listed. Dimensions: 66.3"H x 2.0"W x 2.0"D Breaker Doghouse add 1.44" (87.4mm) to overall depth (1683mm x 51mm x 51mm)	1
Horizontal 60 AMP without Digital Monitor 208V		
HB0B2C3BN03N1	Horizontal power strip 60 A, 208V, 3 IEC C-19 receptacles, three 20 A double pole magnetic breaker/on-off switch with integral switch guard and 10' power cord with IEC 60309 – 2P+E pin in sleeve water tight connector. UL and c-UL Listed. Dimensions: 1.7"H x 17.0"W x 6.5"D (43mm x 431mm x 165mm)	1
Vertical 60 AMP, 3 Phase Delta 208V		
VB0B2G6BN12N1	Vertical power strip 60 A, 208V, Delta, 12 IEC C-19 receptacles, six 20 A double pole magnetic breaker on-off switch with integral switch guard, and 10' power cord with IEC 60309 3P+E pin and sleeve connector. UL and c-UL Listed. Dimensions: 66.3"H x 2"W x 3.5"D (1683mm x 51mm x 89mm)	1
VB0B2G6BN24Z1	Vertical power strip 60 A, 208V, Delta, 12 IEC C-13 and 12 IEC C-19 receptacles, six 20 A double pole magnetic breaker on-off switch with integral switch guard, and 10' power cord with IEC 60309 – 3P+E pin in sleeve connector. UL and c-UL Listed. Dimensions: 66.3"H x 2.3"W x 3.5"D (1683mm x 58mm x 89mm)	1
Vertical 80 AMP, 3 Phase Delta 208V		
VB0B6A4AP12N1	Vertical power strip 80 A, 208V, Delta, 12 IEC C-19 receptacles, four 20 A triple pole magnetic breaker on-off switch with integral switch guard, and hardwired – wiring access panel conduit connection. UL and c-UL Listed. Dimensions: 66.3"H x 3.5"W x 3.5"D (1683mm x 89mm x 89mm)	1

‡For non-metered versions, replace VB1 with VB0, i.e. VB0A1P3BN24E1

Refer to www.panduit.com for detailed information on the complete line of power outlet units.

Auto Transfer Switch (ATS) Units

- Scrolling power meter providing critical information on current draw
- Switches from the primary to the secondary power source
- Dual input power sources for redundancy



HA1AC0CA10E1

Part Number	Part Description	Std. Pkg. Qty.
Horizontal Auto Transfer Switch 20 AMP with and without Digital Monitor 120V		
HA1A1C0CA10E1	Horizontal auto transfer switch 20 A, 120V, 10 NEMA 5-20R receptacles, two LEDs power-on indicators with red LED current monitor, and dual 10' power cord with NEMA 5-20P plug. UL and c-UL Listed. Power Feeds A and B must be Phase Synchronized. Dimensions: 1.72"H x 17.0"W x 9.0"D (44mm x 431mm x 229mm)	1
HA0A1C0CA10E1	Horizontal auto transfer switch 20 A, 120 V, 10 NEMA 5-20R receptacles, two LEDs power-on indicators, and dual 10' power cord with NEMA 5-20P plug. UL and c-UL Listed. Power Feeds A and B must be Phase Synchronized. Dimensions: 1.72"H x 17.0"W x 9.0"D (44mm x 431mm x 229mm)	1
HA1A1D0CA10E1	Horizontal auto transfer switch 20 A, 120V, 10 NEMA 5-20R receptacles, two LEDs power-on indicators with red LED current monitor, and dual 10' power cord with NEMA L5-20P twist lock plug. UL and c-UL Listed. Power Feeds A and B must be Phase Synchronized. Dimensions: 1.72"H x 17.0"W x 9.0"D (44mm x 431mm x 229mm)	1
HA0A1D0CA10E1	Horizontal auto transfer switch 20 A, 120V, 10 NEMA 5-20R receptacles, two LEDs power-on indicators, and dual 10' power cord with NEMA L5-20P twist lock plug. UL and c-UL Listed. Power Feeds A and B must be Phase Synchronized. Dimensions: 1.72"H x 17.0"W x 9.0"D (44mm x 431mm x 229mm)	1
Horizontal Auto Transfer Switch 30 AMP with Digital Monitor 120V		
HA1A1M2CM10E1	Horizontal auto transfer switch 30 A, 120 V, 10 NEMA 5-20R receptacles, two LEDs power-on indicators with red LED current monitor, two 20 A single pole magnetic breaker on-off switch with integral switch guard and, dual 10' power cord with NEMA L5-30P twist lock plugs. UL and c-UL Listed. Power Feeds A and B must be Phase Synchronized. Dimensions: 1.72"H x 17.0"W x 9.0"D (44mm x 431mm x 229mm)	1
HA0A1M2CM10E1	Horizontal auto transfer switch 30 A, 120V, 10 NEMA 5-20R receptacles, two LEDs power-on indicators with two 20 A single pole magnetic breaker on-off switch with integral switch guard, and dual 10' power cord with NEMA L5-30P twist lock plugs. UL and c-UL Listed. Power Feeds A and B must be Phase Synchronized. Dimensions: 1.72"H x 17.0"W x 9.0"D (44mm x 431mm x 229mm)	1

Refer to www.panduit.com for detailed information on the complete line of power outlet units.

Networked Power Outlet Units

- Remote access to power consumption data via a web-based GUI provides global network access to real-time power information
- Integrates with Panduit® PIM™ Software, which aggregates power information through a single web based GUI interface
- Integrated power monitoring and management with on unit display provides true RMS input current load (in amps) for each power circuit or phase to properly load balance and maximize power circuits
- Provides user-defined alarm/messaging capabilities for specific events that exceeded thresholds
- Mounting buttons allow tool-less installation of power strips

**QZ1B1P3BN30P1**

Part Number	Part Description	Std. Pkg. Qty.
Horizontal 20 Amp, 120V Networked Aggregate Monitoring		
PZ1A1C0BA20E1	2 RU horizontal power strip 20 A, 120V, 20 NEMA 5-20R receptacles, RJ-45 Ethernet port with red LED current monitor, and 10' power cord with NEMA 5-20P plug. UL and c-UL Listed. Dimensions: 3.4"H x 1.7"W x 6.0"D (86mm x 43mm x 152mm)	1
PZ1A1D0BA20E1	2 RU Horizontal power strip 20 A, 120V, 20 NEMA 5-20R receptacles, RJ-45 Ethernet port with red LED current monitor, and 10' power cord, NEMA L5-20P twist lock plug. UL and c-UL Listed. Dimensions: 3.4"H x 1.7"W x 6.0"D (86mm x 43mm x 152mm)	1
Vertical 20 AMP, 120V Networked Aggregate Monitoring		
QZ1A1C0BA24E1*	Vertical power strip 20 A, 120V, 24 NEMA 5-20R receptacles, RJ-45 Ethernet port with red LED current monitor, and 10' power cord with NEMA 5-20P plug. UL and c-UL Listed. Dimensions: 66.3"H x 2.0"W x 2.0"D (1683mm x 51mm x 51mm)	1
QZ1A1C0BA30P1*	Vertical power strip 20 A, 120V, 24 IEC C-13 and 6 IEC C-19 receptacles, RJ-45 Ethernet port with red LED current monitor, and 10' power cord with NEMA 5-20P plug. UL and c-UL Listed. Dimensions: 66.3"H x 2.0"W x 2.0"D (1683mm x 51mm x 51mm)	1
Vertical 20 AMP, 208V Networked Aggregate Monitoring		
QZ1B1E0BA30P1‡	Vertical power strip 20 A, 208V, 24 IEC C-13 and 6 IEC C-19 receptacles, RJ-45 Ethernet port with red LED current monitor, and 10' power cord with NEMA 6-20P plug. UL and c-UL Listed. Dimensions: 66.3"H x 2.0"W x 2.0"D (1683mm x 51mm x 51mm)	1
QZ1B1E0BA24H1‡	Vertical power strip 20 A, 208V, 24 NEMA 6-20R receptacles, RJ-45 Ethernet port with red LED current monitor, and 10' power cord with NEMA 6-20P plug. UL and c-UL Listed. Dimensions: 66.3"H x 2.0"W x 2.0"D (1683mm x 51mm x 51mm)	1
Vertical 20 AMP, 3 Phase WYE 120V Networked Circuit (X, Y, Z) Monitoring		
QZ1A1J0BA30P1	Vertical power strip 20 A, 120V WYE, 24 IEC C-13 and 6 IEC C-19 receptacles RJ-45 Ethernet port with red LED current monitor and, 10' power cord with NEMA L21-20P twist lock plug. UL and c-UL Listed. Dimensions: 66.3"H x 2.0"W x 2.0"D (1683mm x 51mm x 51mm)	1
Vertical 20 AMP, 3 Phase WYE 208V Networked Circuit (XY, YZ, ZX) Monitoring		
QZ1B1J0BA30P1	Vertical power strip 20 A, 208V WYE, 24 IEC C-13 and 6 IEC C-19 receptacles RJ-45 Ethernet port with red LED current monitor, and 10' power cord with NEMA L21-20P twist lock plug. UL and c-UL Listed. Dimensions: 66.3"H x 2.0"W x 2.0"D (1683mm x 51mm x 51mm)	1
Vertical 20 AMP, 3 Phase WYE 230/400V Networked Circuit Phase (X,Y, Z) Monitoring		
QZ1D1K0BA30P1	Vertical power strip 20 A, 230/400V, WYE, 24 IEC C-13 and 6 IEC C-19 receptacles, RJ-45 Ethernet port with red LED current monitor, and 10' power cord with NEMA L22-20P twist lock plug. UL and c-UL Listed. Dimensions: 66.3"H x 2.0"W x 2.0"D (1683mm x 51mm x 51mm)	1

*For NEMA L5-20P twist lock plug, replace "C" with "D", i.e. QZ1A1D0BA24E1.

‡For NEMA L6-20P twist lock plug, replace "E" with "F", i.e. QZ1B1F0BA30P1.

Networked Power Outlet Units (continued)



QZ1B1P3BN30P1

Part Number	Part Description	Std. Pkg. Qty.
Vertical 30 AMP, 120V Networked Aggregate/Breaker Monitoring		
QZ1A1M2BM24E1	Vertical power strip 30 A, 120V, 24 NEMA 5-20R receptacles, RJ-45 Ethernet port with red LED current monitor two, 20 A single pole magnetic breaker on-off switch with integral switch guard, and 10' power cord with NEMA L5-30P twist lock plug. UL and c-UL Listed. Dimensions: 66.3"H x 2.0"W x 2.0"D Breaker Doghouse add 1.44" (87.4mm) to overall depth (1683mm x 51mm x 51mm)	1
Vertical 30 AMP, 208V Networked Aggregate/Breaker Monitoring		
QZ1B1L2BN24H1	Vertical power strip 30 A, 208V, 24 NEMA 6-20R receptacles, RJ-45 Ethernet port with red LED current monitor, two 20 A double pole magnetic breaker on-off switch with integral switch guard, and 10' power cord with NEMA L6-30P twist lock plug. UL and c-UL Listed. Dimensions: 66.3"H x 2.0"W x 2.0"D Breaker Doghouse add 1.44" (87.4mm) to overall depth (1683mm x 51mm x 51mm)	1
Half Height Vertical 30 AMP, 208V Networked Aggregate/Breaker Monitoring		
QZ1B1L2BN1441	Vertical power strip 30 A, 208V, 12 IEC C-13 and 2 IEC C-19 receptacles, RJ-45 Ethernet port with red LED current monitor, two 20 A double pole magnetic breaker on-off switch with integral switch guard, and 10' power cord with NEMA L6-30P twist lock plug. UL and c-UL Listed. Dimensions: 33.0"H x 2.0"W x 2.0"D Breaker Doghouse add 1.44" (87.4mm) to overall depth (838mm x 51mm x 51mm)	1
Vertical 30 AMP, 3 Phase WYE 120V Networked Phase/Breaker (X,Y, Z) Monitoring		
QZ1A1P3BN30P1‡‡	Vertical power strip 30 A, 120V, WYE 24 IEC C-13 and 6 IEC C-19 receptacles, RJ-45 Ethernet port with red LED current monitor, three 20 A double pole magnetic breaker on-off switch with integral switch guard and 10' power cord with NEMA L21-30P twist lock plug. UL and c-UL Listed. Dimensions: 66.3"H x 2.0"W x 2.0"D Breaker Doghouse add 1.44" (87.4mm) to overall depth (1683mm x 51mm x 51mm)	1
Vertical 30 AMP, 3 Phase WYE 120/208V Networked Circuit/Breaker (XY,YZ,ZX) Monitoring		
QZ1C1P3BN33X1	Vertical power strip 30 A, 120/208V WYE, 24 IEC C-13 and 3 IEC C-19 and 6 NEMA 5-20R, receptacles, RJ-45 Ethernet port with red LED current monitor, three 20 A double pole magnetic breaker on-off switch with integral switch guard and 10' power cord with NEMA L21-30P twist lock plug. UL and c-UL Listed. Dimensions: 66.3"H x 2.0"W x 2.0"D Breaker Doghouse add 1.44" (87.4mm) to overall depth (1683mm x 51mm x 51mm)	1
QZ1C1P3BN24Y1	Vertical power strip 30 A, 120/208V WYE, 12 IEC C-13 and 6 IEC C-19 and 6 NEMA 5-20R, receptacles, RJ-45 Ethernet port with red LED current monitor, three 20 A double pole magnetic breaker on-off switch with integral switch guard and 10' power cord with NEMA L21-30P twist lock plug. UL and c-UL Listed. Dimensions: 70"H x 2.0"W x 2.0"D Breaker Doghouse add 1.44" (87.4mm) to overall depth (1777mm x 51mm x 51mm)	1
Vertical 30 AMP, 3 Phase WYE 120/208V Networked Circuit/Breaker (XY, YZ, ZX) and Outlet Monitoring		
QQ1C1P3BN24Y1	Vertical power strip 30 A, 120/208V WYE, 12 IEC C-13 and 6 IEC C-19 and 6 NEMA 5-20R, receptacles, RJ-45 Ethernet port with red LED current monitor, three 20 A double pole magnetic breaker on-off switch with integral switch guard and 10' power cord with NEMA L21-30P twist lock plug. UL and c-UL Listed. Dimensions: 70"H x 2.0"W x 2.0"D Breaker Doghouse add 1.44" (87.4mm) to overall depth (1777mm x 51mm x 51mm)	1

‡‡For Delta, replace "P" with "N", i.e. QZ1B1N3BN30P1.

Table continues on page L.48

Networked Power Outlet Units (continued)**QZ1C1P3BN1851****QZ1B2G6BN24Z1**

Part Number	Part Description	Std. Pkg. Qty.
Half Height Vertical 30 AMP, 3 Phase WYE 120/208V Networked Circuit/Breaker (XY, YZ, ZX) Monitoring		
QZ1C1P3BN1851	Vertical power strip 30 A, 120/208V WYE, 9 IEC C-13 and 3 IEC C-19 and 6 NEMA 5-20R receptacles, RJ-45 Ethernet port with red LED current monitor, three 20 A double pole magnetic breaker/on-off switch with integral switch guard, and 10' power cord with NEMA L21-30P twist lock plug. UL and c-UL Listed. Dimensions: 33.0"H x 2.0"W x 2.0"D Breaker Doghouse add 1.44" (87.4mm) to overall depth (838mm x 51mm x 51mm)	1
Vertical 30 AMP, 3 Phase WYE 208V Networked Circuit/Breaker (XY, YZ, ZX) Monitoring		
QZ1B1P3BN30P1 ††	Vertical power strip 30 A, 208V, WYE, 24 IEC C-13 and 6 IEC C-19 receptacles, RJ-45 Ethernet port with red LED current monitor, three 20 A double pole magnetic breaker/on-off switch with integral switch guard and 10' power cord with NEMA L21-30P twist lock plug. UL and c-UL Listed. Dimensions: 66.3"H x 2.0"W x 2.0"D Breaker Doghouse add 1.44" (87.4mm) to overall depth (1683mm x 51mm x 51mm)	1
Vertical 30 AMP, 3 Phase WYE 230/400V Networked Phase/Breaker (X, Y, Z) Monitoring		
QZ1D1Q3BN30P1	Vertical power strip 30 A, 230/400V WYE, 24 IEC C-13 and 6 IEC C-19 receptacles, RJ-45 Ethernet port with red LED current monitor three 20 A double pole magnetic breaker/on-off switch with integral switch guard, and 10' power cord with NEMA L22-30P twist lock plug. UL and c-UL Listed. Dimensions: 66.3"H x 2.0"W x 2.0"D Breaker Doghouse add 1.44" (87.4mm) to overall depth (1683mm x 51mm x 51mm)	1
Vertical 60 AMP, 208V Networked Breaker Monitoring		
QZ1B2C3BN30P1	Vertical power strip 60 A, 208V, 24 IEC C-13 and 6 IEC C-19 receptacles, RJ-45 Ethernet port with red LED current monitor, three 20 A double pole magnetic breaker/on-off switch with integral switch guard, and 10' power cord with IEC 60309 – 2P+E pin in sleeve water tight connector. UL and c-UL Listed. Dimensions: 66.3"H x 2.0"W x 2.0"D Breaker Doghouse add 1.44" (87.4mm) to overall depth (1683mm x 51mm x 51mm)	1
Horizontal 60 AMP, 3 Phase Delta 208V Networked Breaker Monitoring		
PZ1B2G6BN12N1	Horizontal power strip 60 A, 208V, Delta, 12 IEC C-19 receptacles, RJ-45 Ethernet port with red LED current monitor, six 20 A double pole magnetic breaker/on-off switch with integral switch guard and 10' power cord with IEC 60309 – 3P+E pin in sleeve connector. UL and c-UL Listed. Dimensions: 3.4"H x 17.0"W x 9.0"D (86mm x 431mm x 229mm)	1
Vertical 60 AMP, 3 Phase Delta 208V Networked Breaker Monitoring		
QZ1B2G6BN24Z1	Vertical power strip 60 A, 208V, Delta, 12 IEC C-13 and 12 IEC C-19 receptacles, RJ-45 Ethernet port with red LED current monitor, six 20 A double pole magnetic breaker/on-off switch with integral switch guard and 10' power cord with IEC 60309 – 3P+E pin in sleeve connector. UL and c-UL Listed. Dimensions: 66.3"H x 2.3"W x 3.5"D (1683mm x 58mm x 89mm)	1
Vertical 80 AMP, 3 Phase Delta 208V Phase (X, Y, Z) and Outlet Monitoring		
QQ1B6A4AP12N1	Vertical power strip 80 A, 208V, Delta, 12 IEC C-19 receptacles, RJ-45 Ethernet port with red LED current monitor, four 20 A triple pole magnetic breaker/on-off switch with integral switch guard, and hardwired – wiring access panel conduit connection. UL and c-UL Listed. Dimensions: 66.3"H x 3.5"W x 3.5"D (1683mm x 89mm x 89mm)	1

††For Delta, replace "P" with "N", i.e. QZ1B1N3BN30P1.

Networked Power Outlet Units (continued)

60 AMP Networked Monitoring for Nexus



QZ1B2G6BN06L1



PZ1B2G3BN03L1



QZ1B2G5BN2271

Part Number	Part Description	Std. Pkg. Qty.
Vertical 60 AMP, 3 Phase Delta 208 Networked Breaker Monitoring for Nexus 7.5kW Power Supplies		
QZ1B2G6BN06L1	Vertical power strip with a 60 A, 208V, Delta, 6 NEMA L6-30R receptacles RJ-45 Ethernet port with red LED current monitor, six 30 A double pole magnetic breaker/on-off switch with integral switch guard, and 10' power cord with IEC 60309 – 3P+E pin in sleeve connector. UL and c-UL Listed. Dimensions: 66.3"H x 2.25"W x 3.4"D (1683mm x 57mm x 87mm)	1
PZ1B2G3BN03L1	Horizontal power strip with a 60 A, 208V, Delta, 3 NEMA L6-30R receptacles RJ-45 Ethernet port with red LED current monitor, three 30 A double pole magnetic breaker/on-off switch with integral switch guard, and 10' power cord with IEC 60309 – 3P+E pin in sleeve connector. UL and c-UL Listed. Dimensions: 3.4"H x 17.0"W x 9.0"D (86mm x 431mm x 229mm)	1
QZ1B2G3BN03L1	Vertical power strip with a 60 A, 208V, Delta, 3 NEMA L6-30R receptacles RJ-45 Ethernet port with red LED current monitor, three 30 A double pole magnetic breaker/on-off switch with integral switch guard, and 10' power cord with IEC 60309 – 3P+E pin in sleeve connector. UL and c-UL Listed. Dimensions: 30.0"H x 2.25"W x 3.44"D (762mm x 57mm x 87mm)	1
QZ1B2G5BN2271	Vertical power strip with a 60 A, 208V, Delta, 16 IEC C-13, 4 IEC C-19 and 2 NEMA L6-30R receptacles RJ-45 Ethernet port with red LED current monitor, one 30 A and four 20 A double pole magnetic breaker/on-off switch with integral switch guard, and 10' power cord with IEC 60309 – 3P+E pin in sleeve connector. UL and c-UL Listed. Dimensions: 66.3"H x 2.25"W x 3.4"D (1683mm x 57mm x 87mm)	1
Vertical 16 AMP, 230V Networked Aggregate Monitoring		
QZ1D2A0BA30P1	Vertical power strip 16 A, 230V, 24 IEC C-13 and 6 IEC C-19 receptacles, RJ-45 Ethernet port with red LED current monitor with a IEC 60309 – 2P+ E pin in sleeve connector. Complies with IEC 60950-1, EN 55022, EN 55024 and CE Marked. Dimensions: 66.3"H x 2.0"W x 2.0"D (1683mm x 51mm x 51mm)	1
Vertical 16 AMP, 3 Phase WYE 230/400V Networked Circuit Phase (X, Y, Z) Monitoring		
QZ1D2Q0BA30P1	Vertical power strip 16 A, 230/400V, WYE, 24 IEC C-13 and 6 IEC C-19 receptacles, RJ-45 Ethernet port with red LED current monitor and 10' power cord with IEC 60309 3P+N+ E pin in sleeve connector. Complies with IEC 60950-1, EN 55022, EN 55024 and CE Marked. Dimensions: 66.3"H x 2.0"W x 2.0"D (1683mm x 51mm x 51mm)	1
Vertical 32 AMP, 230V Networked Aggregate/Breaker Monitoring		
QZ1D2B2BM30P1	Vertical power strip 32 A, 230V, 24 IEC C-13 and 6 IEC C-19 receptacles, RJ-45 Ethernet port with red LED current monitor, two 16 A single pole magnetic breaker/on-off switch with integral switch guard with a IEC 60309 – 2P+E pin in sleeve connector. Complies with IEC 60950-1, EN 55022, EN 55024 and CE Marked. Dimensions: 66.3"H x 2.0"W x 2.0"D Breaker Doghouse add 1.44" (87.4mm) to overall depth (1683mm x 51mm x 51mm)	1
Vertical 32 AMP, 3 Phase WYE 230/400V Networked Circuit Phase (X, Y, Z) Monitoring		
QZ1D2P3BN30P1	Vertical power strip 32 A, 230/400V, WYE, 24 IEC C-13 and 6 IEC C-19 receptacles, RJ-45 Ethernet port with red LED current monitor, three 16 A single pole magnetic breaker/on-off switch with integral switch guard and 10' power cord with IEC 60309 3P+ N+E, pin in sleeve connector. Complies with IEC 60950-1, EN 55022, EN 55024 and CE Marked. Dimensions: 66.3"H x 2.0"W x 2.0"D Breaker Doghouse add 1.44" (87.4mm) to overall depth (1683mm x 51mm x 51mm)	1



PN1A1C0BA10E1

Networked and Environmental Power Outlet Units

- Remote access to power consumption data via a web-based GUI provides global network access to real-time power information
- Environmental monitoring measures in-cabinet temperature
- Integrates with Panduit[®] PIM™ Software which aggregates power information through a single web interface
- Provides user-defined alarm/messaging capabilities for specific events that exceed thresholds
- Integrated 2 line x 8 character LED display
- Optional remote LED display available for local monitoring, part number PVQ-RD

Part Number	Part Description	Std. Pkg. Qty.
Horizontal 15 AMP, 120V Networked and Environmental Aggregate Monitoring		
PN1A1B0BA10B1	Horizontal power strip 15 A, 120V, 10 NEMA 5-15R receptacles, with LED current monitor, RJ-45 Ethernet port with two RJ12 remote environmental ports, remote display port, and 10' power cord with NEMA 5-15P plug. UL and c-UL Listed. Dimensions: 1.73"H x 17.0"W x 6.5"D (44mm x 432mm x 165mm)	1
Horizontal 20 Amp, 230V Networked and Environmental Aggregate Monitoring		
PN1A1C0BA10E1	Horizontal power strip 20 A, 120V, 10 NEMA 5-20R receptacles, with LED current monitor, RJ-45 Ethernet port with two RJ12 remote environmental ports, remote display port, and 10' power cord with NEMA 5-20P plug. UL and c-UL Listed. Dimensions: 1.73"H x 17.0"W x 6.5"D (44mm x 432mm x 165mm)	1
PN1A1D0BA10E1	Horizontal power strip 20 A, 120V, 10 NEMA 5-20R receptacles, with red LED current monitor, RJ-45 Ethernet port with two RJ12 remote environmental ports, remote display port, and 10' power cord with NEMA L5-20P plug. UL and c-UL Listed. Dimensions: 1.73"H x 17.0"W x 6.5"D (44mm x 432mm x 165mm)	1
PN1A1D0BA12M1	Horizontal power strip 20 A, 120V, 12 IEC C-13 receptacles, with red LED current monitor, RJ-45 Ethernet port with two RJ12 remote environmental ports, remote display port, and 10' power cord with NEMA L5-20P plug. UL and c-UL Listed. Dimensions: 1.73"H x 17.0"W x 6.5"D (44mm x 432mm x 165mm)	1
Vertical 20 AMP, 120V Networked and Environmental Aggregate Monitoring		
QN1A1C0BA24E1	Vertical power strip 20 A, 120V, 24 NEMA 5-20R receptacles, with red LED current monitor, RJ-45 Ethernet port with two RJ12 remote environmental ports, remote display port, and 10' power cord with NEMA 5-20P plug. UL and c-UL Listed. Dimensions: 66.3"H x 2.0"W x 2.0"D (1683mm x 51mm x 51mm)	1
Vertical 20 AMP, 3 Phase WYE 120V Networked and Environmental Phase (X, Y, Z) Monitoring		
QN1A1J0BA24E1	Vertical power strip 20 A, 120V, WYE, 24 NEMA 5-20R receptacles, with red LED current monitor, RJ-45 Ethernet port with two RJ12 remote environmental ports, remote display port, and 10' power cord with NEMA L21-20P twist lock plug. UL and c-UL Listed. Dimensions: 66.3"H x 2.0"W x 2.0"D (1683mm x 51mm x 51mm)	1
Vertical 20 AMP, 3 Phase WYE 208V Networked and Environmental Circuit (X, Y, Z) Monitoring		
QN1B1J0BA30P1	Vertical power strip 20 A, 208V, WYE, 24 IEC C-13 and 6 IEC C-19 receptacles RJ-45 Ethernet port with two RJ12 remote environmental display ports, remote display port, and 10' power cord with NEMA L21-20P twist lock plug. UL and c-UL Listed. Dimensions: 66.3"H x 2.0"W x 2.0"D (1683mm x 51mm x 51mm)	1

Networked and Environmental Power Outlet Units (continued)

Part Number	Part Description	Std. Pkg. Qty.
Vertical 30 AMP, 120V Networked and Environmental Circuit Breaker Level Monitoring		
QN1A1M2BM24E1	Vertical power strip 30 A, 120V, 24 NEMA 5-20R receptacles, with red LED current monitor, RJ-45 Ethernet port with two RJ12 remote environmental ports, remote display port, two 20 A single pole magnetic breaker/on-off switch with integral switch guard, and 10' power cord with NEMA L5-30P twist lock plug. UL and c-UL Listed. Dimensions: 66.3"H x 2.0"W x 2.0"D Breaker Doghouse add 1.44" (87.4) to overall depth (1683mm x 51mm x 51mm)	1
Vertical 30 AMP, 208V Networked and Environmental Circuit Breaker Monitoring		
QN1B1L2BN30P1	Vertical power strip 30 A, 208V, 24 IEC C-13 and 6 IEC C-19 receptacles, with red LED current monitor, RJ-45 Ethernet port with two RJ12 remote environmental ports, remote display port, two 20 A double pole magnetic breaker/on-off switch with integral switch guard, and 10' power cord with NEMA L6-30P twist lock plug. UL and c-UL Listed. Dimensions: 66.3"H x 2.0"W x 2.0"D Breaker Doghouse add 1.44" (87.4) to overall depth (1683mm x 51mm x 51mm)	1
QN1B1L2BN24H1	Vertical power strip 30 A, 208V, 24 NEMA 6-20R receptacles, with red LED current monitor, RJ-45 Ethernet port with two RJ12 remote environmental ports, remote display port, two 20 A double pole magnetic breaker/on-off switch with integral switch guard, and 10' power cord with NEMA L6-30P twist lock plug. UL and c-UL Listed. Dimensions: 66.3"H x 2.0"W x 2.0"D Breaker Doghouse add 1.44" (87.4) to overall depth (1683mm x 51mm x 51mm)	1
Half Height Vertical 30 Amp, 208V Networked and Environmental Circuit Breaker Monitoring		
QN1B1L2BN0861	Vertical power strip 30 A, 208V, 6 IEC C-13 and 2 IEC C-19 receptacles, with red LED current monitor, RJ-45 Ethernet port with two RJ12 remote environmental ports, remote display port, two 20 A double pole magnetic breaker/on-off switch with integral switch guard, and 10' power cord with NEMA L6-30P twist lock plug. UL and c-UL Listed. Dimensions: 33.0"H x 2.0"W x 2.25"D Breaker Doghouse add 1.44" (87.4) to overall depth (838mm x 51mm x 57mm)	1
Half height Vertical 30 AMP, 208V Networked and Environmental Secondary with Uplink Port, Circuit Breaker Monitoring		
QD0B1L2BN0861	Vertical power strip 30 A, 208V, 6 IEC C-13 and 2 IEC C-19 receptacles, RJ-45 Ethernet port with two RJ12 remote environmental ports, one uplink port to daisy chain units together, two 20 A double pole magnetic breaker/on-off switch with integral switch guard, and 10' power cord with NEMA L6-30P twist lock plug. UL and c-UL Listed. Dimensions: 33.0"H x 2.0"W x 2.25"D Breaker Doghouse add 1.44" (87.4mm) to overall depth (838mm x 51mm x 57mm)	1
Vertical 30 AMP, 3 Phase WYE 120V Networked and Environmental Phase/Breaker (X, Y, Z) Monitoring		
QN1A1P3BN30P1	Vertical power strip 30 A, 120V, WYE, 24 IEC C-13 and 6 IEC C-19 receptacles with red LED current monitor, RJ-45 Ethernet port with two RJ12 remote environmental ports and remote display port, three 20 A double pole magnetic breaker/on-off switch with integral switch guard, and 10' power cord with NEMA L21-30P twist lock plug. UL and c-UL Listed. Dimensions: 66.3"H x 2.0"W x 2.0"D Breaker Doghouse add 1.44" (87.4) to overall depth (1683mm x 51mm x 51mm)	1
QN1A1P3BN24E1	Vertical power strip 30 A, 120 V, WYE, 24 NEMA 5-20R receptacles, with red LED current monitor, RJ-45 Ethernet port with two RJ12 remote environmental ports and remote display port, three 20 A double pole magnetic breaker/on-off switch with integral switch guard, and 10' power cord with NEMA L21-30P twist lock plug. UL and c-UL Listed. Dimensions: 66.3"H x 2.0"W x 2.0"D Breaker Doghouse add 1.44" (87.4mm) to overall depth (1683mm x 51mm x 51mm)	1



QN1B1L2BN0861

Table continues on page L.52

**QN1B1P3BN30P1****QN1D2A0BA30P1****Networked and Environmental Power Outlet Units (continued)**

Part Number	Part Description	Std. Pkg. Qty.
Vertical 30 AMP, 3 Phase WYE 208V Networked and Environmental Phase/Breaker (X, Y, Z) Monitoring		
QN1B1P3BN30P1	Vertical power strip 30 A, 208V, WYE, 24 IEC C-13 and 6 IEC C-19 receptacles, with red LED current monitor, RJ-45 Ethernet port with two RJ12 remote environmental ports and remote display port, three 20 A double pole magnetic breaker on-off switch with integral switch guard, and 10' power cord with NEMA L21-30P twist lock plug. UL and c-UL Listed. Dimensions: 66.3"H x 2.0"W x 2.0"D Breaker Doghouse add 1.44" (87.4mm) to overall depth (1683mm x 51mm x 51mm)	1
QN1B1P3BN24H1	Vertical power strip 30 A, 208 V, WYE, 24 NEMA 6-20R receptacles, RJ-45 Ethernet port with two RJ12 remote environmental ports, three 20 A double pole magnetic breaker/on-off switch with integral switch guard, and 10' power cord with NEMA L21-30P twist lock plug. UL and c-UL Listed. Dimensions: 66.3"H x 2.0"W x 2.0"D Breaker Doghouse add 1.44" (87.4mm) to overall depth (1683mm x 51mm x 51mm)	1
Vertical 60 Amp, 3 Phase WYE 208V Networked and Environmental Phase Monitoring (X, Y, Z)		
QN1B2G6BN24R1	Vertical switched power strip 60 A, 208V, Delta, 18 IEC C-13 and 6 IEC C-19 receptacles, RJ-45 Ethernet port with two RJ12 remote environmental ports, red LED current monitor and remote display port, six 20 A double pole magnetic breaker/on-off switch with integral switch guard, and 10' power cord with IEC 60309 – 3P+E plug. UL and c-UL Listed. Dimensions: 66.3"H x 2.3"W x 3.4"D (1683mm x 58mm x 87mm)	1
Vertical 16 AMP, 230V Networked and Environmental Aggregate Monitoring		
QN1D2A0BA30P1	Vertical power strip 16 A, 230V, 24 IEC C-13 and 6 IEC C-19 receptacles, with LED current monitor, RJ-45 Ethernet port with two RJ12 remote environmental ports, and remote display port, and 3m power cord with IEC 60309 – 2P+E, pin in sleeve connector. Complies with IEC 60950-1, EN 55022, EN 55024 and CE Marked. Dimensions: 66.3"H x 2.0"W x 2.3"D (1683mm x 51mm x 58mm)	1
Vertical 16 AMP, 3 Phase WYE 230/400V Networked and Environmental Phase Monitoring (X, Y, Z)		
QN1D2Q0BA30P1	Vertical power strip 16 A, 230/400V, WYE, 24 IEC C-13 and 6 IEC C-19 receptacles, with red LED current monitor, RJ-45 Ethernet port with two RJ12 remote environmental ports, and remote display port, and 3m power cord with IEC 60309 – 3P+ N+ E, pin in sleeve connector. Complies with IEC 60950-1, EN 55022, EN 55024 and CE Marked. Dimensions: 66.3"H x 2.0"W x 2.3"D (1683mm x 51mm x 58mm)	1
Vertical 32 AMP, 230V Networked and Environmental Breaker Monitoring		
QN1D2B2BN30P1	Vertical power strip 32 A, 230V, 24 IEC C-13 and 6 IEC C-19 receptacles, with LED current monitor, RJ-45 Ethernet port with two RJ12 remote environmental ports, two and remote display port, two 16 A double pole magnetic breaker/on-off switch with integral switch guard, and 3m power cord with IEC 60309 – 2P+E pin in sleeve connector. Complies with IEC 60950-1, EN 55022, EN 55024 and CE Marked. Dimensions: 66.3"H x 2.0"W x 2.3"D Breaker Doghouse add 1.44" (87.4mm) to overall depth (1683mm x 51mm x 58mm)	1
Vertical 32 AMP, 3 Phase WYE 230/400V Networked and Environmental (X, Y, Z) Monitoring		
QN1D2P3BN30P1	Vertical power strip 32 A, 230/400V, WYE, 24 IEC C-13 and 6 IEC C-19 receptacles, with LED current monitor, RJ-45 Ethernet port with two RJ12 remote environmental ports, and remote display port, three 16 A double pole magnetic breaker/on-off switch with integral switch guard, and 3m power cord with IEC 60309 – 3P+N+E, pin in sleeve connector. Complies with IEC 60950-1, EN 55022, EN 55024 and CE Marked. Dimensions: 66.3"H x 2.0"W x 2.3"D Breaker Doghouse add 1.44" (87.4mm) to overall depth (1683mm x 51mm x 58mm)	1

Switched with Per Outlet Monitoring Power Outlet Units

- Remote switching capability for power cycling individual outlets or a group of outlets on or off to reboot equipment or power off individual outlets to stop unauthorized use
- Per outlet monitoring provides data to determine if power allocations are accurate and the efficiency metric of any server in the data center allowing individual servers to be identified as candidates for additional capacity, redeployment, or decommissioning
- Time delay sequencing avoids circuit overload due to high in-rush current at equipment start up
- Remote access to power consumption data via a web-based GUI provides global network access to real-time power information
- Locking receptacles support and retain any standard IEC power cords preventing unintentional power loss
- Integrates with Panduit® PIM™ Software which aggregates power information through a single web based GUI
- Measure in-cabinet temperature, humidity, airflow, and dew point remotely to prevent environmental factors that can cause equipment to overheat or malfunction
- Alarm messaging capability provides user-defined alarm/messaging capabilities for specific events that exceeded thresholds
- Each outlet has a green LED for indication if the outlet is on or off for easy visual identification
- Optional remote LED display available for local monitoring, part number PVQ-RD
- Integrated 2 line x 8 character LED display



Part Number	Part Description	Std. Pkg. Qty.
Vertical 20 AMP, 208V Switched with Per Outlet Power and Environmental Monitoring		
QL1B1F0BA2401*	Vertical switched power strip with per outlet power and environmental monitoring, 20 A, 208V, WYE, 21 IEC C-13 and 3 IEC C-19 locking receptacles RJ-45 Ethernet port with two RJ12 remote environmental ports, and 10' power cord with NEMA L21-20P twist lock plug. UL and c-UL Listed. Dimensions: 66.3"H x 2.5"W x 2.3"D (1683mm x 64mm x 57mm)	1
Vertical 20 AMP, 3 Phase WYE 230/400V Switched with Per Outlet Power and Environmental Monitoring		
QL1D1K0BA2401*	Vertical switched power strip 20 A, 230/400V, WYE, 21 IEC C-13 and 3 IEC C-19 locking receptacles RJ-45 Ethernet port with two RJ12 remote environmental ports, and 10' power cord with NEMA L22-20P twist lock plug. UL and c-UL Listed. Dimensions: 66.3"H x 2.5"W x 2.3"D (1683mm x 64mm x 57mm)	1
Vertical 20 AMP, 3 Phase WYE 208V Switched with Per Outlet Power and Environmental Monitoring		
QL1B1J0BA2401*	Vertical switched power strip with per outlet power and environmental monitoring, 20 A, 208V, WYE, 21 IEC C-13 and 3 IEC C-19 locking receptacles RJ-45 Ethernet port with two RJ12 remote environmental ports, and 10' power cord with NEMA L21-20P twist lock plug. UL and c-UL Listed. Dimensions: 66.3"H x 2.5"W x 2.3"D (1683mm x 64mm x 57mm)	1
Vertical 30 AMP, 208V Switched with Per Outlet Power and Environmental Monitoring		
QL1B1L2BN24AA1*	Vertical switched power strip with per outlet power and environmental monitoring, 30 A, 208V, 20 IEC C-13 and 4 IEC C-19 locking receptacles, RJ-45 Ethernet port with two RJ12 remote environmental ports, two 20 A double pole magnetic breaker/on-off switch with integral switch guard, and 10' power cord with NEMA L6-30P twist lock plug. UL and c-UL Listed. Dimensions: 70.00"H x 2.5"W x 2.3"D Breaker Doghouse add 1.44" (87.4mm) to overall depth (1778mm x 64mm x 57mm)	1

*For aggregate, phase, or breaker only monitoring, replace "QL" with "QS", i.e. QS1B1F0BA2401.

Table continues on page L.55

Switched with per Outlet Monitoring Power Outlet Units (continued)

Part Number	Part Description	Std. Pkg. Qty.
Vertical 30 AMP, 3 Phase WYE 208V Switched with Per Outlet Power and Environmental Monitoring		
QL1B1P3BN2491*	Vertical switched power strip with per outlet power and environmental monitoring, 30 A, 208V, WYE, 18 IEC C-13 and 6 IEC C-19 locking receptacles, RJ-45 Ethernet port with two RJ12 remote environmental ports, three 20 A double pole magnetic breaker/on-off switch with integral switch guard, and 10' power cord with NEMA L21-30P twist lock plug. UL and c-UL Listed. Dimensions: 72.0"H x 2.5"W x 2.3"D Breaker Doghouse add 1.44" (87.4mm) to overall depth (1829mm x 64mm x 57mm)	1
QL1B1N3BN2401*	Vertical switched power strip with per outlet power and environmental monitoring, 30 A, 208V, Delta, 21 IEC C-13 and 3 IEC C-19 locking receptacles, RJ-45 Ethernet port with two RJ12 remote environmental ports, three 20 A double pole magnetic breaker/on-off switch with integral switch guard, and 10' power cord with NEMA 15-30P twist lock plug. UL and c-UL Listed. Dimensions: 72.0"H x 2.5"W x 2.3"D Breaker Doghouse add 1.44" (87.4mm) to overall depth (1829mm x 64mm x 57mm)	1
Vertical 30 AMP, 3 Phase WYE 230/400V Switched with Per Outlet Power and Environmental Monitoring		
QL1D1Q3BN2401*	Vertical power strip 30 A, 230/400V, WYE, 21 IEC C-13 and 3 IEC C-19 locking receptacles, RJ-45 Ethernet port with two RJ12 remote environmental ports, three 20 A double pole magnetic breaker/on-off switch with integral switch guard, and 10' power cord with NEMA L22-30P twist lock plug. UL and c-UL Listed. Dimensions: 72.0"H x 2.5"W x 2.3"D Breaker Doghouse add 1.44" (87.4mm) to overall depth (1829mm x 64mm x 57mm)	1
Vertical 60 AMP, 3 Phase Delta 208V Switched with Per Outlet Power and Environmental Monitoring		
QL1B2G6BN2491	Vertical switched power strip with per outlet power and environmental monitoring, 60 A, 208V, Delta, 18 IEC C-13 and 6 IEC C-19 locking receptacles, red LED current monitor, RJ-45 Ethernet port with two RJ12 remote environmental ports, six 20 A double pole magnetic breaker/on-off switch with integral switch guard, and 10' power cord with IEC 60309 – 3P+E plug. UL and c-UL Listed. Dimensions: 66.0"H x 4.0"W x 3.4"D (1683mm x 102mm x 87mm)	1

*For aggregate, phase, or breaker only monitoring, replace "QL" with "QS", i.e. QS1B1F0BA2401.

Switched with per Outlet Monitoring Power Outlet Units (continued)

Part Number	Part Description	Std. Pkg. Qty.
Vertical 16 AMP, 230V Switched with Per Outlet Power and Environmental Monitoring		
QL1D2A0BA2401*	Vertical switched power strip with per outlet power and environmental monitoring 16 A, 230V, 21 IEC C-13 and 3 IEC C-19 locking receptacles, RJ-45 Ethernet port with two RJ12 remote environmental ports, and 3m power cord with IEC 60309 – 2P+E pin in sleeve connector. Complies with IEC 60950-1, EN 55022, EN 55024, and CE Marked. Dimensions: 66.3"H x 2.5"W x 2.3"D (1683mm x 64mm x 57mm)	1
Vertical 16 AMP, 3 Phase WYE 230/400V Switched with Per Outlet Power and Environmental Monitoring		
QL1D2Q0BA2401	Vertical switched power strip with per outlet power and environmental monitoring, 16 A, 230/400V, WYE, 21 IEC C-13 and 3 IEC C-19 locking receptacles, red LED current monitor, RJ-45 Ethernet port with two RJ12 remote environmental ports, and 3mm power cord with IEC 60309 – 3P+ N+ E, pin in sleeve connector. Complies with IEC 60950-1, EN 55022, EN 55024 and CE Marked. Dimensions: 66.3"H x 2.5"W x 2.3"D (1683mm x 64mm x 57mm)	1
Vertical 32 AMP, 230V Switched with Per Outlet Power and Environmental Monitoring		
QL1D2B2BN24AA1*	Vertical power strip 32 A, 230V, 20 IEC C-13 and 4 IEC C-19 locking receptacles, RJ-45 Ethernet port with two RJ12 remote environmental ports, two 16 A double pole magnetic breaker/on-off switch with integral switch guard, and 3m power cord with IEC 60309 – 2P+E pin in sleeve connector. Complies with IEC 60950-1, EN 55022, EN 55024 and CE Marked. Dimensions: 66.3"H x 2.0"W x 2.25"D Breaker Doghouse add 1.44" (87.4mm) to overall depth (1683mm x 51mm x 58mm)	1
Vertical 32 AMP, 3 Phase WYE 230/400 Switched with Per Outlet Power and Environmental Monitoring		
QL1D2P3BN2401*	Vertical power strip 32 A, 230/400V, WYE, 21 IEC C-13 and 3 IEC C-19 locking receptacles, RJ-45 Ethernet port with two RJ12 remote environmental ports, three 16 A double pole magnetic breaker/on-off switch with integral switch guard, and 3m power cord with IEC 60309 – 3P+N+E pin in sleeve connector. Complies with IEC 60950-1, EN 55022, EN 55024 and CE Marked. Dimensions: 66.3"H x 2.0"W x 2.25"D Breaker Doghouse add 1.44" (87.4mm) to overall depth (1683mm x 51mm x 58mm)	1

*For aggregate, phase, or breaker only monitoring, replace "QL" with "QS", i.e. QS1B1F0BA2401.

Environmental Sensors

Designed specifically for the QN, QS, QL, and PL series power outlet units. The sensors provide temperature, humidity, and airflow information. The remote display allows for local monitoring via a LED display.



PVQ-RD



PVQ-EST18



PVQ-ESDP



PVQ-ESW

Part Number	Part Description	Std. Pkg. Qty.
PVQ-RD	Remote Display Monitor, RJ-11 connection cord, mounting bracket, adhesive pads, and hardware.	1
PVQ-EST-18	Environmental temperature sensor with 18' cord, includes: 15 (19") adhesive cord clips, 15 (.38") adhesive cord clips, 10 push mount ties, .29" cable clamp and hardware.	1
PVQ-ESTAFHD-18	Temperature, humidity, airflow, and dew point sensor with 18' cord. Includes: 15 (19") adhesive cord clips, 10 (.38") adhesive cord clips, 15 push mount ties, 2 (.29") cable clamp and hardware.	1
PVQ-ESDP-NS	PViQ™ Environmental Door Position Sensor with 30' cord, includes: 2 doors sensors, brackets, 15 (19") adhesive cord clips, 10 (.38") adhesive cord clips, 15 push mount ties, 2 (.29") cable clamp and hardware.	1
PVQ-ESDP-NA	PViQ™ Environmental Door Position Sensor with 30' cord, includes: 2 doors sensors, brackets, 15 (19") adhesive cord clips, 10 (.38") adhesive cord clips, 15 push mount ties, 2 (.29") cable clamp and hardware.	1
PVQ-ESDP	PViQ™ Environmental Door Position Sensor with 30' cord.	1
PVQ-ESW	PViQ™ Environmental Water Sensor with 20' cord.	1

Power Cords

- Power Cords are of optimal lengths between POUs and active equipment to minimize excess lengths and cord slack
- Improve cable management and increase air circulation for better thermal performance.
- A variety of configurations available for multiple application environments



PC14C13BL1.5

Part Number	Length		Color	Std. Pkg. Qty.
	Ft.	mm		
IEC 320 C14 to IEC 320 C13				
PC14C13BL1.5	1.5	460.0	Black	1
PC14C13BL2	2.0	610.0	Black	1
PC14C13BL3	3.3	1000.0	Black	1
PC14C13BL4	4.0	1220.0	Black	1
PC14C13BL5	5.0	1500.0	Black	1
PC14C13BL6.5	6.5	2000.0	Black	1
PC14C13BL7	7.0	2134.0	Black	1
PC14C13BL8	8.0	2500.0	Black	1
PC14C13BL9	9.0	2740.0	Black	1
PC14C13BL10	10.0	3050.0	Black	1
PC14C13GY1.5	1.5	460.0	Gray	1
PC14C13GY2	2.0	610.0	Gray	1
PC14C13GY3	3.3	1000.0	Gray	1
PC14C13GY4	4.0	1220.0	Gray	1
PC14C13GY5	5.0	1500.0	Gray	1
PC14C13GY6.5	6.5	2000.0	Gray	1
PC14C13GY7	7.0	2134.0	Gray	1
PC14C13GY8	8.0	2500.0	Gray	1
PC14C13GY9	9.0	2740.0	Gray	1
PC14C13GY10	10.0	3050.0	Gray	1
IEC 320 C20 to IEC 320 C13				
PC20C13BL1.5	1.5	460.0	Black	1
PC20C13BL3	3.3	1000.0	Black	1
PC20C13BL6	6.0	1830.0	Black	1
IEC 320 C20 to IEC 320 C19				
PC20C19BL3	3.3	1000.0	Black	1
PC20C19BL4	4.0	1220.0	Black	1
PC20C19BL5	5.0	1500.0	Black	1
PC20C19BL6	6.0	1830.0	Black	1
PC20C19GY3	3.3	1000.0	Gray	1
PC20C19GY4	4.0	1220.0	Gray	1
PC20C19GY5	5.0	1500.0	Gray	1
PC20C19GY6	6.0	1830.0	Gray	1

Table continues on page L.58

Power Cords (continued)

Part Number	Length		Color	Std. Pkg. Qty.
	Ft.	mm		
NEMA 5-15 to IEC 320 C13				
P515C13BL1.5	1.5	460.0	Black	1
P515C13BL3	3.0	950.0	Black	1
P515C13BL6	6.0	1830.0	Black	1
P515C13BL7	7.0	2134.0	Black	1
P515C13GY3	3.0	950.0	Gray	1
P515C13GY6	6.0	1830.0	Gray	1
NEMA 5-15 to IEC 320 C19				
P515C19BL1.5	1.5	460.0	Black	1
P515C19BL3	3.0	950.0	Black	1
P515C19BL6	6.0	1830.0	Black	1
NEMA 5-20 to IEC 320 C19				
P520C19BL1.5	1.5	460.0	Black	1
P520C19BL3	3.0	950.0	Black	1
P520C19BL6	6.0	1830.0	Black	1
NEMA 6-20 to IEC 320 C19				
P620C19BL1.5	1.5	460.0	Black	1
P620C19BL3	3.0	950.0	Black	1
P620C19BL6	6.0	1830.0	Black	1

Power Cord Retainers

- Eliminate accidental plug disconnection from power outlet units providing secure connections; reducing the risk of equipment downtime
- Suitable for Panduit power cords and Panduit power outlet units



Part Number	Part Description	Std. Pkg. Qty.
PRPC13W-2.0-X	C13 retaining clip for power outlet units with 2.00 inch chassis.	10
PRPC13W-2.25-X	C13 retaining clip for power outlet units with 2.25 inch chassis.	10
PRPC19Y-2.0-X	C19 retaining clip for power outlet units with 2.00 inch chassis.	10
PRPC19Y-2.25-X	C19 retaining clip for power outlet units with 2.25 inch chassis.	10

4 Post Rack System Roadmap

- Supports deep networking equipment; the rack combines the stability of a cabinet with the accessibility of an open rack to provide maximum flexibility

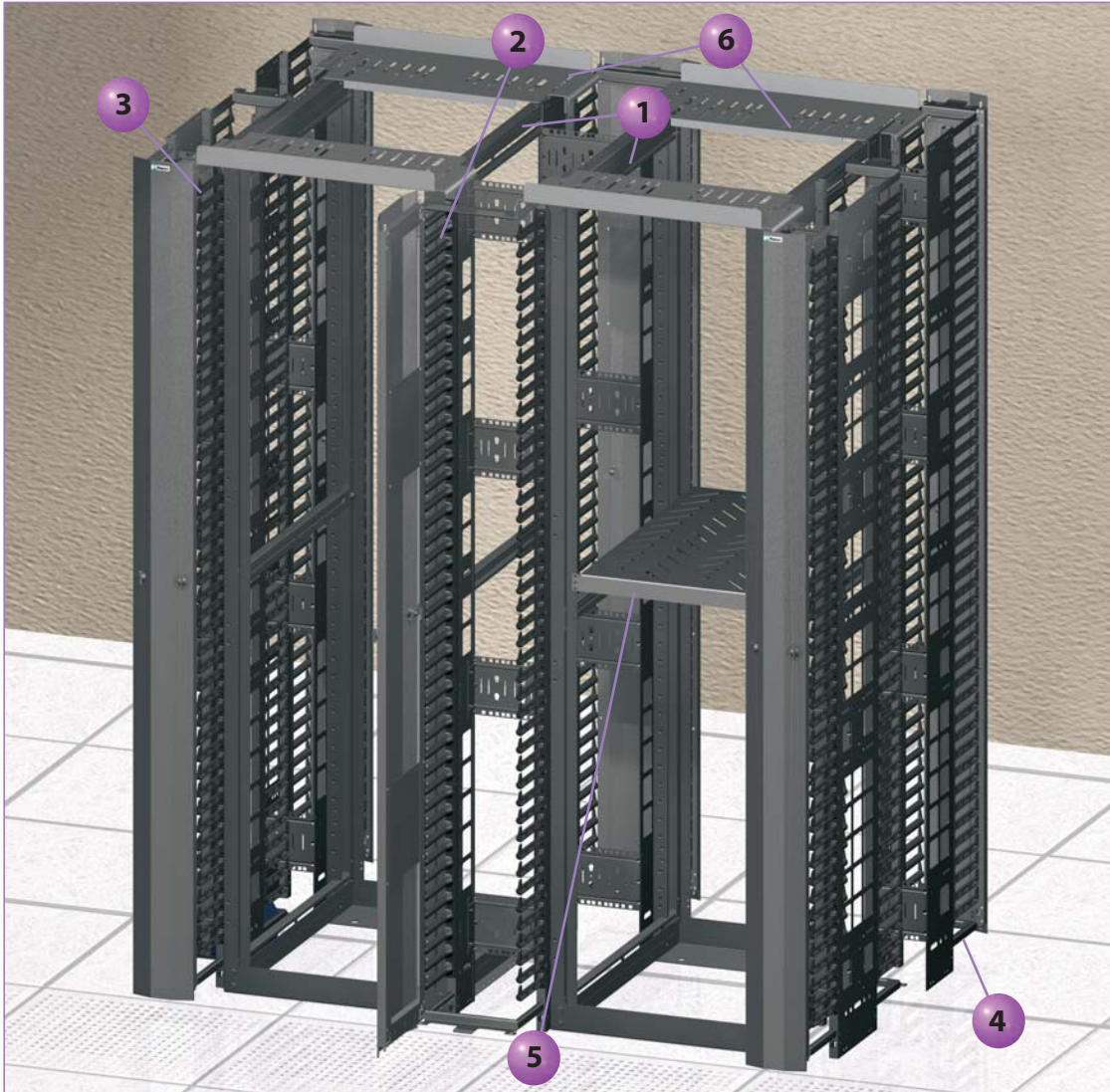

- 1** R4P – 4 Post Rack
84"H x 23.3"W x 30.0"D (45RU)
R4P23 – 4 Post Rack
84"H x 23.3"W x 23.0"D
45 RU (not shown)
R4P36 – 4 Post Rack
84"H x 23.3"W x 36.0"D
45 RU (not shown)
R4P42 – 4 Post Rack
84"H x 23.3"W x 41.5"D
45 RU (not shown)
(page L.60)

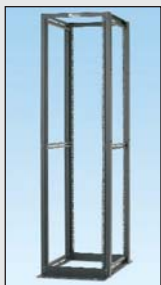

- 2** PatchRunner™ High Capacity
Vertical Managers Available
in 6", 8", 10", 12" widths to
fit 7' racks
(page L.65 – L.68)



- 5** RSHLF – 4 Post Rack Shelf
19"H x 30"W
RSHLF23 – 4 Post Rack Shelf
19"H x 23"W
RSHLF36 – 4 Post Rack Shelf
19"H x 36"W
(page L.61)



- 6** R4PWF – Top Trough with
waterfall creates pathway
above rack 26.1"W x 8.5"D
(page L.61)

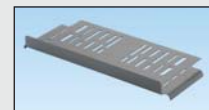

4 Post Racks available in cage nut versions.

4 Post Cable Management Rack System and Accessories

- Independent adjustable front and rear mounting rails can be adjusted while the rack is secured to the floor
- Printed rack space identification on all equipment rails allows for quick location of rack spaces, speeding installation of rack mount items (shipped numbers up per TIA606 specifications; can be set to number down by flipping the rails)
- Rack is UL listed for 2,500 lbs. load rating
- Rear rail construction provides a clear ventilation path for side ventilated switches
- Multiple mounting holes in top flanges for securing ladder rack
- Weld nut construction eliminates the need for a second wrench increasing speed and ease of assembly
- Multiple mounting locations for vertical power strips on any of the four posts or on the adjustable mounting rails
- PatchRunner™ and NetRunner™ Vertical Cable Managers mount directly to the 4 post rack at any of the four corners to provide a flexible end-to-end cable management solution
- Paint piercing washers included to electrically bond rack for simplified grounding
- For the complete grounding solution, see the StructuredGround™ Kits for Racks selection guide on pages M.12 – M.13

**R4P**

Part Number	Part Description	No. of Rack Spaces [^]	Std. Pkg. Qty.
7' 4 Post Rack Threaded Rail			
R4P23	EIA rack with #12-24 threaded rails. Dimensions: 84.0"H x 23.25"W x 23.0"D (2134mm x 591mm x 584mm).	45	1
R4P‡	4 post EIA rack with #12-24 threaded rails. Dimensions: 84.0"H x 23.25"W x 30.0"D (2134mm x 591mm x 762mm).	45	1
R4P36	4 post EIA rack with #12-24 threaded rails. Dimensions: 84.0"H x 23.25"W x 36.0"D (2134mm x 591mm x 914mm).	45	1
R4P42	4 post EIA rack with #12-24 threaded rails. Dimensions: 84.0"H x 23.25"W x 41.5"D (2134mm x 591mm x 1054mm).	45	1
7' 4 Post Rack Cage Nut Rail			
R4P23CN	4 post EIA rack with cage nut rails. Dimensions: 84.0"H x 23.25"W x 23.0"D (2134mm x 591mm x 584mm).	45	1
R4PCN	4 post EIA rack with cage nut rails. Dimensions: 84.0"H x 23.25"W x 30.0"D (2134mm x 591mm x 762mm).	45	1
R4P36CN	4 post EIA rack with cage nut rails. Dimensions: 84.0"H x 23.25"W x 36.0"D (2134mm x 591mm x 914mm).	45	1
R4P42CN	4 post EIA rack with cage nut rails. Dimensions: 84.0"H x 23.25"W x 41.5"D (2134mm x 591mm x 1054mm).	45	1

[^]One rack space = 1.75" (44.45mm).

All product color is black.

‡For 42 RU add suffix 79 to the end of part number and for 42 RU cage nut version add suffix CN79 to the end of the part number.

4 Post Cable Management Rack System and Accessories (continued)



R4P96



R4PAE1



R4PAE2



R4PAE3



R4PWF



RSHLF



RCSTR

Part Number	Part Description	No. of Rack Spaces [^]	Std. Pkg. Qty.
8' 4 Post Rack Threaded Rail			
R4P2396	4 post EIA rack with #12-24 threaded rails. Dimensions: 96.0"H x 23.25"W x 23.0"D (2441mm x 591mm x 584mm).	52	1
R4P96	4 post EIA rack with #12-24 threaded rails. Dimensions: 96.0"H x 23.25"W x 30.0"D (2441mm x 591mm x 762mm).	52	1
R4P3696	4 post EIA rack with #12-24 threaded rails. Dimensions: 96.0"H x 23.25"W x 36.0"D (2441mm x 591mm x 914mm).	52	1
R4P4296	4 post EIA rack with #12-24 threaded rails. Dimensions: 96.0"H x 23.25"W x 41.5"D (2441mm x 591mm x 1054mm).	52	1
8' 4 Post Rack Cage Nut Rail			
R4P23CN96	4 post EIA rack with cage nut rails. Dimensions: 96.0"H x 23.25"W x 23.0"D (2441mm x 591mm x 584mm).	52	1
R4PCN96	4 post EIA rack with cage nut rails. Dimensions: 96.0"H x 23.25"W x 30.0"D (2441mm x 591mm x 762mm).	52	1
R4P36CN96	4 post EIA rack with cage nut rails. Dimensions: 96.0"H x 23.25"W x 36.0"D (2441mm x 591mm x 914mm).	52	1
R4P42CN96	4 post EIA rack with cage nut rails. Dimensions: 96.0"H x 23.25"W x 41.5"D (2441mm x 591mm x 1054mm).	52	1
4 Post Rack Accessories			
R4PAE1	Panduit 4 post rack thermal duct for use with Cisco* 6509, 6509E, 6513, 9513 Director and Juniper 8208 switches.	—	1
R4PAE2	Panduit 4 post rack thermal ducting for use with Cisco* 7018 switch.	—	1
R4PAE3	Panduit 4 post rack thermal ducting for use with Cisco* 7009 switch.	—	1
R4PWF	Top trough with waterfall creates pathway above rack. Dimensions: 1.9"H x 26.1"W x 8.5"D (50mm x 662mm x 216mm).	—	1
RSHLF23	4 post rack mount shelf. Load rating 275 lbs.(124.7 kg). Dimensions: 1.7"H x 19.0"W x 23.0"D (44mm x 483mm x 584mm).	1	1
RSHLF	4 post rack mount shelf. Load rating 275 lbs. (124.7 kg). Dimensions: 1.7"H x 19.0"W x 30.0"D (44mm x 483mm x 762mm).	1	1
RSHLF36	4 post rack mount shelf. Load rating 275 lbs. (124.7 kg). Dimensions: 1.7"H x 19.0"W x 36.0"D (44mm x 483mm x 914mm).	1	1
RCSTR	4 post rack casters.	—	1

[^]One rack space = 1.75" (44.45mm).

All product color is black.

*Cisco is a registered trademark of Cisco Technology Inc.

Table continues on page L.62

4 Post Cable Management Rack System and Accessories (continued)

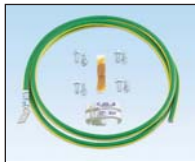

Part Number	Part Description	No. of Rack Spaces [^]	Std. Pkg. Qty.
R4PFP	Adjustable vertical filler panel for Panduit 4 Post Racks blocks by-pass air and directs cold airflow through equipment when used.	45	1
R4PFR	Right vertical finger section for cable management.	11	1
R4PFL	Left vertical finger section for cable management.	11	1
R4PFM	Finger managers for 7 and 8 foot Panduit 4 Post Racks.	—	1
CVPPB	Bracket to vertically mount 1 RU EIA 19" copper and fiber patch panels to the side of the Net-Access™ Cabinet posts or 4 post racks.	—	1
CNSPE	Net-Access™ Network Cabinet and 4 post rack end channel slack spools. Package includes one left and one right slack spool and mounting brackets.	—	1
CVPDUB	Bracket for vertical POU mounting to the side of the Net-Access™ Cabinet posts or 4 post racks (kit of two).	—	1
R4PRT	#12-24 Threaded rails (one pair). 45 RU.	45	1
R4PRCN	Cage nut rails (one pair). 45 RU.	45	1
RFAKIT	Rack anchor kit for concrete floor (set of four).	—	1
S1224-C	#12-24 x .5" mounting screws.	—	100
CNWS1224-C	#12-24 cage nut and screws.	—	100
CNWSM5-C	M5 screw with cage nut.	—	100
CNWSM6-C	M6 screw with cage nut.	—	100
RGCBNJ660P22	#6 AWG (16mm ²) jumper; 60" (1.52m) length; 45° bent lug on grounding strip side; provided with .16 oz. (5cc) of antioxidant, two each #12-24 x 1/2", M6 x 12mm, #10-32 x 1/2" and M5 x 12mm thread-forming screws and a copper compression HTAP* for connecting to the MCBN.	—	1

[^]One rack space = 1.75" (44.45mm).

All product color is black.

‡For 42 RU add suffix 79 to the end of part number and for 42 RU cage nut version add suffix CN79 to the end of the part number.

2 Post Cable Management Rack System and Accessories

- Rack space identification allows quick and easy location of rack mount items
- 3" Rack is UL listed for 1,000 lbs. load rating
- 6" Rack is UL listed for 1,500 lbs. load rating
- Double-sided #12-24 EIA universal mounting hole spacing
- 24 #12-24 mounting screws included
- Can be used with all Panduit cable management and patch panel products in addition to any industry standard 19" components
- Paint piercing washers included to electrically bond rack for simplified grounding; for the complete grounding solution, see the StructuredGround™ Kits for Racks
- 6" rack, R2P6S is compatible with Patchrunner™ and High Capacity PatchRunner™ products only

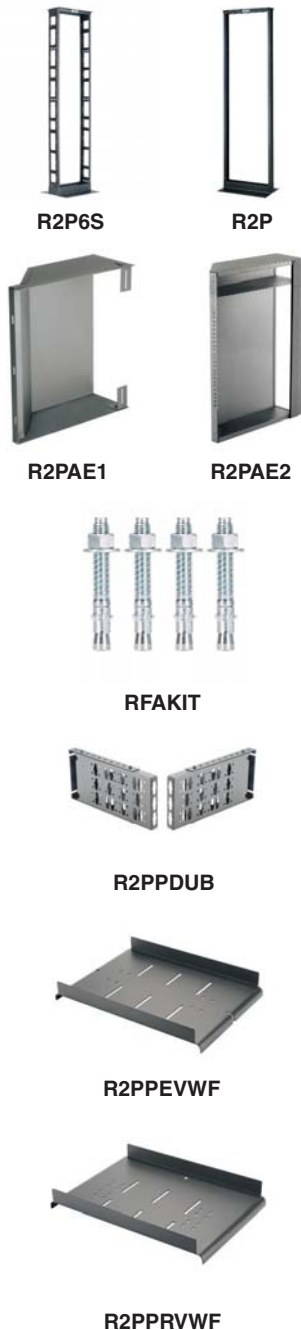

Part Number	Part Description	No. of Rack Spaces [^]	Std. Pkg. Qty.	Std. Ctn. Qty.
6" Channel Rack – Numbered Up				
R2P6S	19" EIA rack, 6" channel, steel. Dimensions: 84.0"H x 20.3"W x 6"D (2134mm x 514mm x 152mm). Note: This rack is compatible with PatchRunner™ and High Capacity PatchRunner™ Vertical Cable Managers only.	45	1	0
R2P6S96	19" EIA rack, 6" channel, steel. Dimensions: 96.0"H x 20.3"W x 6"D (2438mm x 514mm x 152mm). Note: This rack is compatible with PatchRunner™ and High Capacity PatchRunner™ Vertical Cable Managers only.	52	1	0
3" Channel Racks – Numbered Up				
R2P96	19" EIA rack, aluminum. Dimensions: 96.0"H x 20.3"W x 3.0"D (2134mm x 514mm x 76mm).	52	1	0
R2P‡	19" EIA rack, aluminum. Dimensions: 84.0"H x 20.3"W x 3.0"D (2134mm x 514mm x 76mm).	45	1	0
R2P48	19" EIA rack, aluminum. Dimensions: 48.0"H x 20.3"W x 3.0"D (1219mm x 514mm x 76mm).	24	1	0
R2PW	23" EIA rack, aluminum. Dimensions: 84.0"H x 24.3"W x 3.0"D (2134mm x 616mm x 76mm).	45	1	0
2 Post Rack Accessories				
R2PAE1	2 post rack thermal duct for use with Cisco ^{^^} 6509 and 6509E Catalyst switches.	—	1	0
R2PAE2	2 post rack thermal duct for use with Cisco ^{^^} 7009 switch.	—	1	0
RFAKIT	Rack anchor kit for concrete floor (set of four).	—	1	10
S1224-C	#12-24 x .5" mounting screws.	—	100	1000
R2PPDUB	Power Outlet Unit (POU) bracket for 2 and 4 post racks (set of two).	—	1	0
R2PPEVWF	Waterfall Trough for 2 Post Rack and PatchRunner™ High Capacity Vertical Cable Managers.	—	1	0
R2PPRVWF	Waterfall Trough for 2 Post Rack and PatchRunner™ Vertical Cable Managers.	—	1	0

[^]One rack space = 1.75" (44.45mm).

All product color is black.

^{^^}Cisco is a registered trademark of Cisco Technology, Inc.

[‡]For 42 RU add suffix 79 to the end of part number.

Table continues on page L.64

2 Post Cable Management Rack System and Accessories (continued)



Part Number	Part Description	No. of Rack Spaces [^]	Std. Pkg. Qty.	Std. Ctn. Qty.
2 Post 3" Channel Racks Numbered Up with Dual-Sided Vertical Cable Managers				
RWMPV45E	#12-24 threaded equipment mounting rails with front and rear manager. Dimensions: 84.0"H x 25.5"W x 15"D (2134mm x 648mm x 381mm)	45	1	0
RWMPVHC45E	#12-24 threaded equipment mounting rails with front and rear manager. Dimensions: 84.0"H x 27.4"W x 15"D (2134mm x 695mm x 381mm)	45	1	0
RNRV6	#12-24 threaded equipment mounting rails with front and rear manager. Dimensions: 84.0"H x 27.1"W x 15"D (2134mm x 689mm x 381mm)	45	1	0
RNRV10	#12-24 threaded equipment mounting rails with front and rear manager. Dimensions: 84.0"H x 30.4"W x 15"D (2134mm x 773mm x 381mm)	45	1	0
2 Post 3" Channel Racks Numbered Up with Single Sided Vertical Cable Managers				
RWMPVF45E	#12-24 threaded equipment mounting rails with a front only manager. Dimensions: 84.0"H x 25.5"W x 15"D (2134mm x 648mm x 381mm)	45	1	0
RWMPVHCF45E	#12-24 threaded equipment mounting rails with a front only manager. Dimensions: 84.0"H x 27.4"W x 15"D (2134mm x 695mm x 381mm)	45	1	0

[^]One rack space = 1.75" (44.45mm).
All product color is black.

PatchRunner™ High Capacity Vertical Cable Management System



Cable Capacity Chart

Part Number	60% Capacity Channel					40% Capacity Channel					RU Capacity	
	Channel Area (in. ²)	Cat. 6A(SD) (0.240" dia.)	Cat. 6A (0.300" dia.)	Cat. 6 (0.240" dia.)	Cat. 5e (0.225" dia.)	Area (in. ²)	Cat. 6A(SD) (0.240" dia.)	Cat. 6A (0.300" dia.)	Cat. 6 (0.240" dia.)	Cat. 5e (0.225" dia.)	Total	
PEV6 (dual-sided) PEVF6 (single sided)	64.8	531	340	531	605	46.2	357	228	357	406	3 rows of 2 RU	6
PEV8 (dual-sided) PEVF8 (single sided)	83.4	733	469	733	834	65	501	320	501	570	3 rows of 3 RU	9
PEV10 (dual-sided) PEVF10 (single sided)	121	936	599	936	1065	83.4	644	412	644	733	3 rows of 4 RU	12
PEV12 (dual-sided) PEVF12 (single sided)	147	1137	728	1147	1294	102	789	505	789	897	3 rows of 6 RU (6 with limited depth)	12/18

PatchRunner™ High Capacity Vertical Cable Managers Roadmap

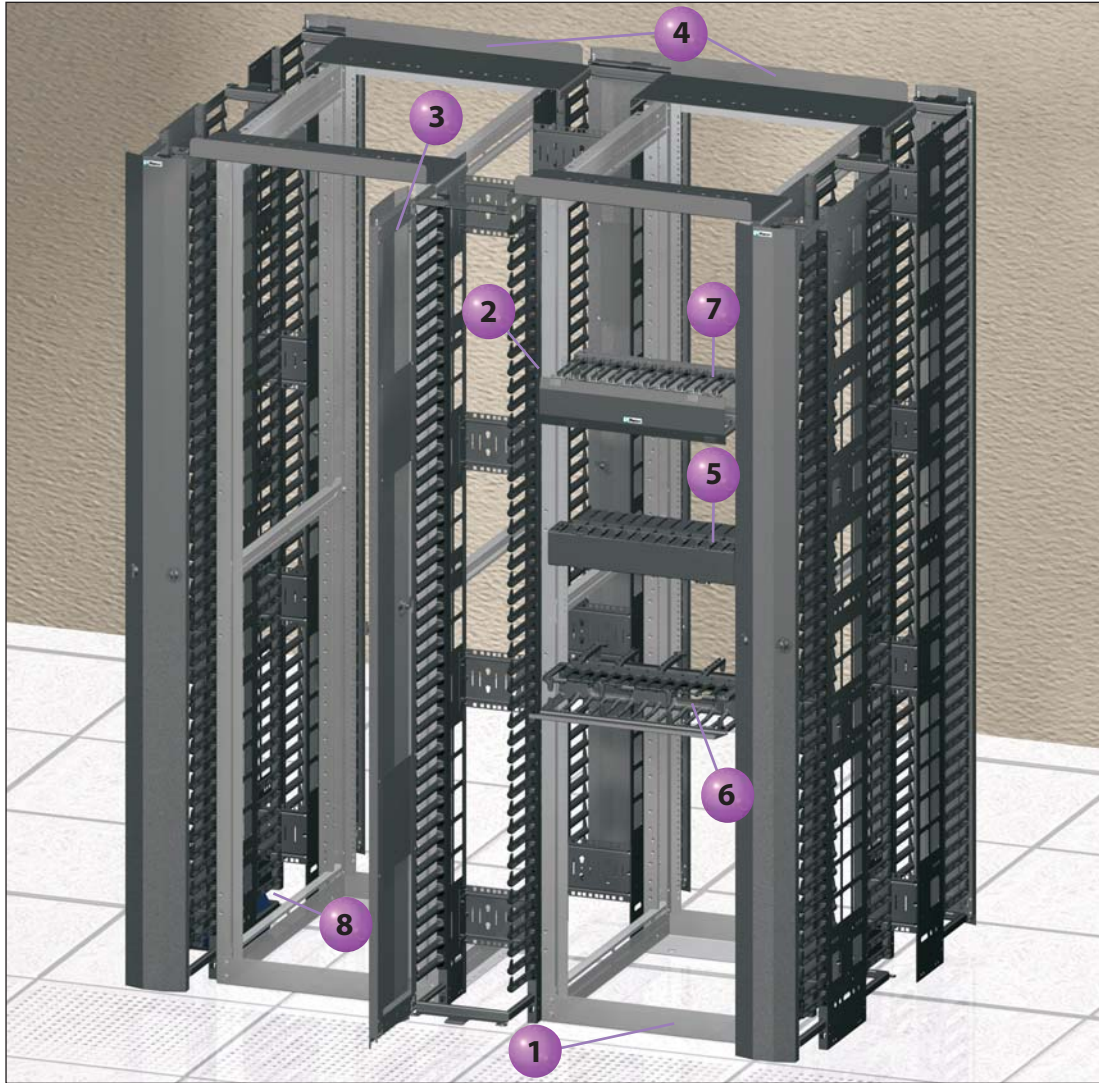

- 1** **R4P – 4 Post Rack**
84.0"H x 23.25"W x 30.0"D,
45 rack units (RU)
- R4P23 – 4 Post Rack**
84.0"H x 23.25"W x 23.0"D,
45 RU (not shown)
- R4P36 – 4 Post Rack**
84.0"H x 23.25"W x 36.0"D,
45 RU (not shown)
- R4P42 – 4 Post Rack**
84.0"H x 23.25"W x 41.5"D,
45 RU (not shown) (page L.60)
- 2** **PatchRunner™ High Capacity
Vertical Cable Managers**
Available in 6", 8", 10", and
12" widths (page L.65 – L.68)
- 3** **PatchRunner™ High Capacity
Dual Hinged Metal Doors**
Available in 6", 8", 10", and 12"
widths (page L.67)

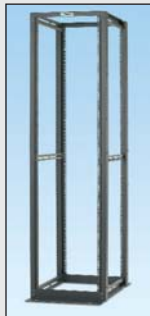

- 4** **R4PWF – Rack Top Trough with
Waterfall creates pathway above rack**
(page L.61)
- 5** **NCMH2 – NetManager™ Horizontal
Cable Manager**
(page L.79)
- 6** **NM2 – NetManager™ High Capacity
Horizontal Cable Manager**
(page L.78)
- 7** **PEHF3 – PatchRunner™ High Capacity
Horizontal Cable Manager**
(page L.80)
- 8** **RFG6X8 – Cool Boot® Raised Floor Air
Sealing Grommet**
(pages L.90 and L.91)



PatchRunner™ High Capacity Vertical Cable Management System

- High density minimizes area required for network layout, freeing up valuable floor space
- Allows mounting of many standard EIA 19" accessories, such as patch panels, vertically in the manager
- Ventilated side walls provide maximum airflow for equipment cooling
- Snap on finger sections can be removed to improve airflow, and break away fingers allow routing of large cable bundles
- Large finger spacing accommodates up to 48 Cat6A cables
- Optional sure close dual hinged metal doors provide easy access to vertical pathway and provides visual and audible feedback on closure
- Available in 7 foot version



PEV



PEVF



PED

Part Number	Part Description	No. of Rack Spaces [^]	Std. Pkg. Qty.	Std. Ctn. Qty.
Vertical Manager – Dual Sided				
PEV6*	High capacity dual sided vertical manager. Dimensions: 83.5"H x 6.0"W x 28.1"D (2120mm x 152mm x 714mm)	45	1	—
PEV8*	High capacity dual sided vertical manager. Dimensions: 83.5"H x 8.0"W x 28.1"D (2120mm x 203mm x 714mm)	45	1	—
PEV10*	High capacity dual sided vertical manager. Dimensions: 83.5"H x 10.0"W x 28.1"D (2120mm x 254mm x 714mm)	45	1	—
PEV12*	High capacity dual sided vertical manager. Dimensions: 83.5"H x 12.0"W x 28.1"D (2120mm x 305mm x 714mm)	45	1	—
Vertical Manager – Single Sided				
PEVF6*	High capacity single sided vertical manager. Dimensions: 83.5"H x 6.0"W x 15.9"D (2120mm x 152mm x 404mm)	45	1	—
PEVF8*	High capacity single sided vertical manager. Dimensions: 83.5"H x 8.0"W x 15.9"D (2120mm x 203mm x 404mm)	45	1	—
PEVF10*	High capacity single sided vertical manager. Dimensions: 83.5"H x 10.0"W x 15.9"D (2120mm x 254mm x 404mm)	45	1	—
PEVF12*	High capacity single sided vertical manager. Dimensions: 83.5"H x 12.0"W x 15.9"D (2120mm x 305mm x 404mm)	45	1	—
PatchRunner™ High Capacity Dual Hinged Doors				
PED6*	Dual hinged metal door. Dimensions: 82.8"H x 6.1"W x 1.7"D (2103mm x 155mm x 43mm)	45	1	—
PED8*	Dual hinged metal door. Dimensions: 82.8"H x 8.1"W x 1.7"D (2103mm x 206mm x 43mm)	45	1	—
PED10*	Dual hinged metal door. Dimensions: 82.8"H x 10.1"W x 1.7"D (2103mm x 256mm x 43mm)	45	1	—
PED12*	Dual hinged metal door. Dimensions: 82.8"H x 12.1"W x 1.7"D (2103mm x 307mm x 43mm)	45	1	—

[^]One rack space = 1.75" (44.45mm).

All product color is black.

* For part numbers that fit 8' rack, add "96" to end of part number. Overall height for managers is 95.5" (2426mm). Overall door height is 94.8" (2409mm).

PatchRunner™ High Capacity Vertical Cable Management System (continued)



PEVBRC



PEVEP



SRB19D5BL



SRB19D7BL



WR5E-X

Part Number	Part Description	No. of Rack Spaces [^]	Std. Pkg. Qty.	Std. Ctn. Qty.
Accessories				
PEVBRC6	Horizontal cross brace bend radius control clips for PatchRunner™ High Capacity Vertical Cable Managers PEV6 and PEVF6.	—	1	10
PEVBRC8	Horizontal cross brace bend radius control clips for PatchRunner™ High Capacity Vertical Cable Managers PEV8 and PEVF8.	—	1	10
PEVBRC10	Horizontal cross brace bend radius control clips for PatchRunner™ High Capacity Vertical Cable Managers PEV10 and PEVF10.	—	1	10
PEVBRC12	Horizontal cross brace bend radius control clips for PatchRunner™ High Capacity Vertical Cable Managers PEV12 and PEVF12.	—	1	10
PEVEP	End Panel. Dimensions: 83.7"H x 23.2"W x .5"D (2125mm x 590mm x 12mm).	—	1	—
SRB19D5BL	Strain relief bar extends 5" off the rack; supports, manages, and provides proper bend radius protection.	—	1	10
SRB19D7BL	Strain relief multi-depth bar extends 7" off the rack; supports, manages, and provides proper bend radius protection. Ideal for use with Category 6A copper cabling installations.	—	1	10
WR5E-X	Snap-on finger cable retainers.	—	10	100

[^]One rack space = 1.75" (44.45mm)
All product color is black

PatchRunner™ Vertical Cable Management Rack System

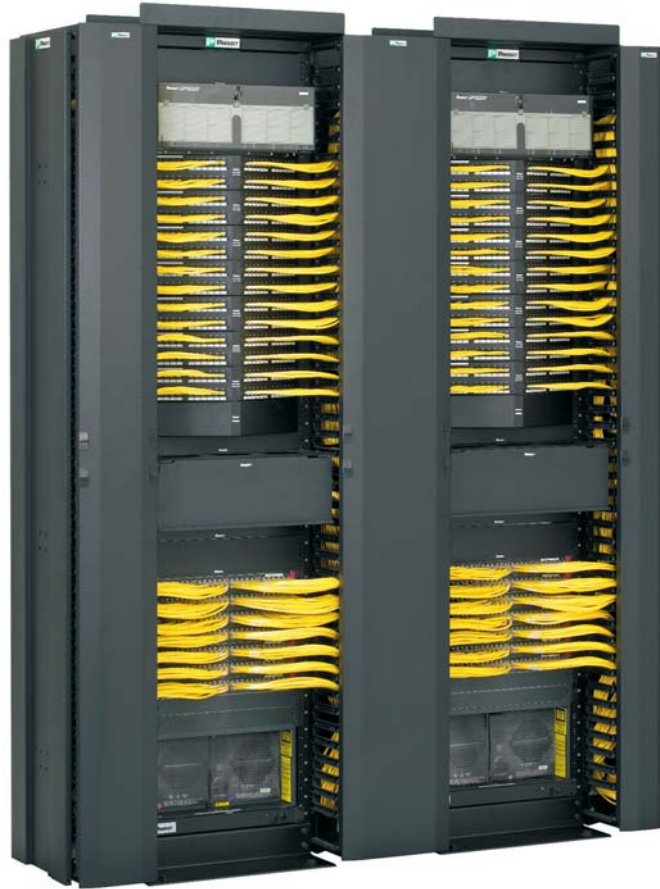

Cable Capacity Chart

Part Number	Front Channel w/ Spool						Front Channel No Spool					Rear Channel			
	Channel Area (In ²)	Cable Capacity				Channel Area (In ²)	Cable Capacity				Channel Area (In ²)	Cable Capacity			
		Cat 6A-SD (0.240)	Cat 6A (0.300)	Cat 6 (0.240)	Cat 5e (0.225)		Cat 6A-SD (0.240)	Cat 6A (0.300)	Cat 6 (0.240)	Cat 5e (0.225)		Cat 6A-SD (0.240)	Cat 6A (0.300)	Cat 6 (0.240)	Cat 5e (0.225)
PRV6* (Dual Sided)	28.22	—	—	—	—	37.8	292	187	292	332	27.6	213	136	213	243
PRVF6* (Single Sided)	28.22	—	—	—	—	37.8	292	187	292	332	—	—	—	—	—
PRV8* (Dual Sided)	44.68	345	221	345	393	54.3	419	268	419	477	39.0	301	193	301	343
PRVF8* (Single Sided)	44.68	345	221	345	393	54.3	419	268	419	477	—	—	—	—	—
PRV10* (Dual Sided)	61.14	473	302	473	538	70.7	547	350	547	622	50.3	389	249	389	443
PRVF10* (Single Sided)	61.14	473	302	473	538	70.7	547	350	547	622	—	—	—	—	—
PRV12* (Dual Sided)	77.6	600	384	600	683	87.2	674	431	674	767	61.7	477	305	477	543
PRVF12* (Single Sided)	77.6	600	384	600	683	87.2	674	431	674	767	—	—	—	—	—
PRV15* (Dual Sided)	102.3	791	506	791	900	111.9	865	554	865	984	78.7	609	389	609	693
PRVF15* (Single Sided)	102.3	791	506	791	900	111.9	865	554	865	984	—	—	—	—	—

Capacities are based on a fill rate of 35% to accommodate proper cable routing techniques. For comparison, multiply by 1.5 for a fill rate of 50%. The above cable diameters represent the nominal Panduit cable diameter per performance level. *For part numbers that are 8 foot tall, add "96" to the end of the part number.

PatchRunner™ Vertical Cable Management Rack System Roadmap

- Vertical cable management system that can manage high-density network equipment and patch panels in up to half the number of racks required by traditional horizontal and vertical cable management systems

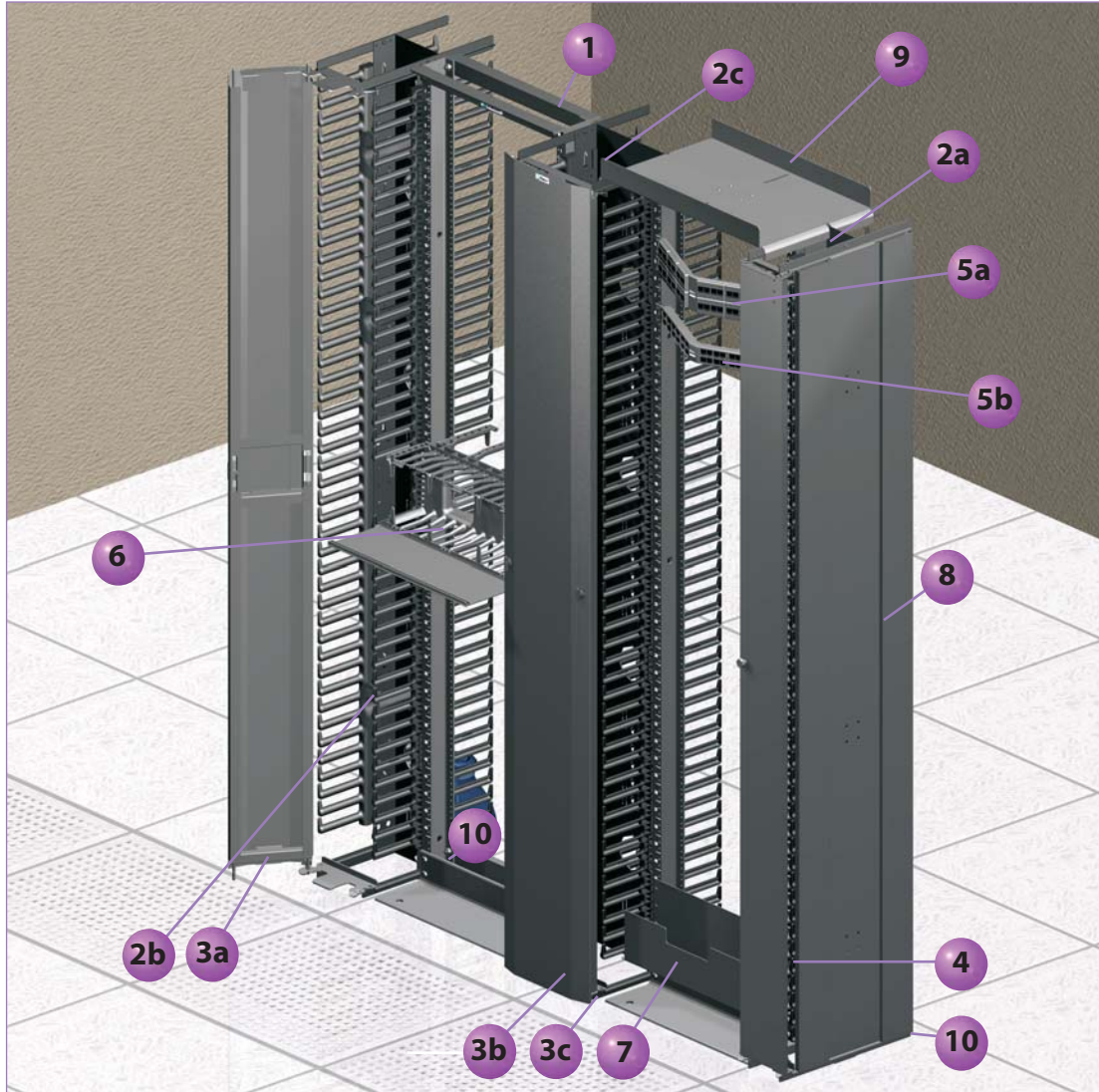

- 1** R2P – 19" Standard EIA Rack 19" x 7', 45 RU (page L.63)
- PatchRunner™ VERTICAL MANAGERS**
- 2a** PRV6 – 6" wide (page L.71)
- 2b** PRV8 – 8" wide (page L.71)
- 2c** PRV12 – 12" wide (page L.71)
- HINGED DOORS**
- 3a** PRD8 – Dual Hinge, 8" wide (page L.71)
- 3b** PED12 – Dual Hinge, 12" wide (page L.72)
- 3c** PEDK12 – Bracket Kit (page L.72)
- 4** PRSHD6 – Single Hinge, 6" wide (shown) (page L.72)

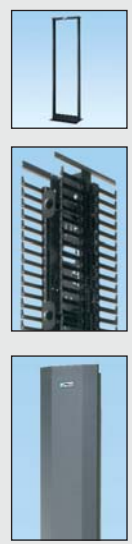

- ANGLED MODULAR PATCH PANELS**
- 5a** CPPLA48WBLY – 2 RU, 48-Port (page B.69)
- 5b** CPPA48HDWBLY – 1 RU, High Density 48-Port (page B.68)
- 6** NM4 – Cable Pathway, 4 RU (page L.78)
- 7** CMT4 – Trough, 4 RU (page L.82)
- 8** PREP – End Panel (page L.72)
- 9** R2PPRVWF – Rack Top Trough (page L.63)
- 10** RFG6X8 – Cool Boot® Raised Floor Air Sealing Grommet (pages L.90 and L.91)



PatchRunner™ Vertical Cable Management System

- High density minimizes area required for network layout, freeing up valuable floor space
- Curved cable management fingers support cables as they transition to the vertical pathway eliminating the need for horizontal managers
- Individual fingers can be removed without the use of a tool for routing of large cable bundles
- Fingers align with rack spaces simplifying cable routing
- Slack management spools organize and manage patch cord slack allowing standardization of patch cords
- Optional hinged doors provide easy access to vertical pathway; purchased separately from manager
- Available in 7 foot and 8 foot versions



PRV8

PRVF8



PRD

Part Number	Part Description	No. of Rack Spaces [^]	Std. Pkg. Qty.	Std. Ctn. Qty.
Vertical Manager – Manage Cable on Front and Rear of Rack*				
PRV6*‡	Vertical cable manager, spools are not included. Dimensions: 84"H x 6"W x 16.4"D (2133.6mm x 152.4mm x 417mm)	45	1	—
PRV8*	Vertical cable manager, includes four PRSP7 slack spools. Dimensions: 83.9"H x 8.0"W x 16.4"D (2131mm x 203mm x 417mm)	45	1	—
PRV10*	Vertical cable manager, includes four PRSP7 slack spools. Dimensions: 83.9"H x 10.0"W x 16.4"D (2131mm x 254mm x 417mm)	45	1	—
PRV12*‡	Vertical cable manager, includes four PRSP7 slack spools. Dimensions: 83.9"H x 12.0"W x 16.4"D (2131mm x 305mm x 417mm)	45	1	—
PRV15*	Vertical cable manager, includes four PRSP7 slack spools. Dimensions: 83.9"H x 15.0"W x 16.4"D (2131mm x 381mm x 417mm)	45	1	—
Vertical Manager – Manage Cable on Front of Rack Only*				
PRVF6*‡	Vertical cable manager, spools are not included. Dimensions: 83.9"H x 6.0"W x 9.7"D (2131mm x 152mm x 246mm)	45	1	—
PRVF8*	Vertical cable manager, includes four PRSP7 slack spools. Dimensions: 83.9"H x 8.0"W x 9.7"D (2131mm x 203mm x 246mm)	45	1	—
PRVF10*	Vertical cable manager, includes four PRSP7 slack spools. Dimensions: 83.9"H x 10.0"W x 9.7"D (2131mm x 254mm x 246mm)	45	1	—
PRVF12*‡	Vertical cable manager, includes four PRSP7 slack spools. Dimensions: 83.9"H x 12.0"W x 9.7"D (2131mm x 305mm x 246mm)	45	1	—
PRVF15*	Vertical cable manager, includes four PRSP7 slack spools. Dimensions: 83.9"H x 15.0"W x 9.7"D (2131mm x 381mm x 246mm)	45	1	—
PatchRunner™ Doors				
PRD6*‡	Dual hinged metal door. Dimensions: 82.8"H x 6.1"W x 1.6"D (2104mm x 206mm x 40mm)	45	1	—
PRD8*	Dual hinged metal door. Dimensions: 82.8"H x 8.1"W x 1.6"D (2104mm x 206mm x 40mm)	45	1	—
PRD10*	Dual hinged metal door. Dimensions: 82.8"H x 10.1"W x 1.6"D (2104mm x 257mm x 40mm)	45	1	—
PRD12*‡	Dual hinged metal door. Dimensions: 82.8"H x 12.1"W x 1.6"D (2104mm x 308mm x 40mm)	45	1	—

[^]One rack space = 1.75" (44.45mm).

All product color is black.

*For part numbers that fit 8' rack, add "96" to end of part number. Overall height for managers is 95.5" (2426mm). Overall door height is 94.4" (2399mm).

‡For 42 RU add suffix 79 to the end of part number.

PatchRunner™ Vertical Cable Management System (continued)



PRSHD8



PED



PEDK



PRSP7



PREP

Part Number	Part Description	No. of Rack Spaces [^]	Std. Pkg. Qty.	Std. Ctn. Qty.
PRD15*	Dual hinged metal door. Dimensions: 82.8"H x 15.1"W x 1.6"D (2104mm x 384mm x 40mm)	45	1	—
PRSHD6	Single hinged metal door. Dimensions: 80.7"H x 6.0"W x .8"D (2049mm x 152mm x 20mm)	45	1	—
PRSHD8	Single hinged metal door. Dimensions: 80.7"H x 8.0"W x .8"D (2049mm x 203mm x 20mm)	45	1	—
PRSHD12	Single hinged metal door. Dimensions: 80.7"H x 12.0"W x .8"D (2049mm x 305mm x 20mm)	45	1	—

PatchRunner™ High Capacity Dual Hinged Metal Doors

PED6*	Dual hinged metal door. Dimensions: 82.8"H x 6.1"W x 1.7"D (2103mm x 155mm x 43mm)	45	1	—
PED8*	Dual hinged metal door. Dimensions: 82.8"H x 8.1"W x 1.7"D (2103mm x 206mm x 43mm)	45	1	—
PED10*	Dual hinged metal door. Dimensions: 82.8"H x 10.1"W x 1.7"D (2103mm x 256mm x 43mm)	45	1	—
PED12*	Dual hinged metal door. Dimensions: 82.8"H x 12.1"W x 1.7"D (2103mm x 307mm x 43mm)	45	1	—

PED Door Brackets

PEDK6	Bracket kit to allow a PED6 door to be attached to a PRV6 PatchRunner™ Vertical Manager.	—	1	10
PEDK8	Bracket kit to allow a PED8 door to be attached to a PRV8 PatchRunner™ Vertical Manager.	—	1	10
PEDK10	Bracket kit to allow a PED10 door to be attached to a PRV10 PatchRunner™ Vertical Manager.	—	1	10
PEDK12	Bracket kit to allow a PED12 door to be attached to a PRV12 PatchRunner™ Vertical Manager.	—	1	10

Accessories

PRSP7	Molded plastic slack spool, front only. Dimensions: 7.0"D x 1.3" dia. (178mm x 32mm)	—	1	10
PRSP5	Molded plastic slack spool, front or rear. Dimensions: 5.25"D x 1.3" dia. (133mm x 32mm)	—	1	10
PREP*	End panel Dimensions: 82.5"H x 14.5"W x .7"D (2095mm x 367mm x 18mm)	—	1	—
WR5E-X	Snap-on finger cable retainers.	—	10	100

[^]One rack space = 1.75" (44.45mm).

All product color is black.

*For part numbers that fit 8' rack, add "96" to end of part number. Overall height for managers is 95.5" (2426mm).

Overall door height is 94.4" (2399mm).

NetRunner™ High Capacity Vertical Cable Managers Roadmap

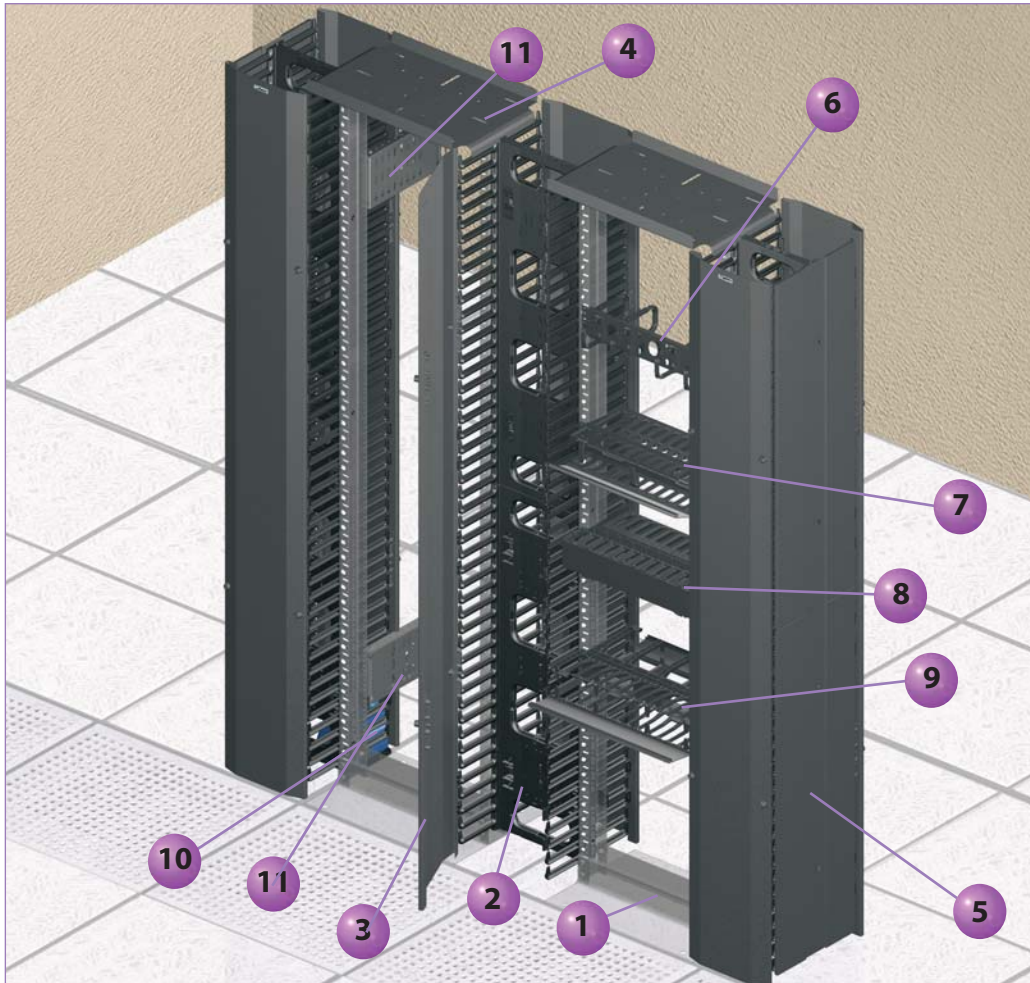

1 R2P – 19" Standard EIA Rack, 19" x 7", 45 RU (page L.63)

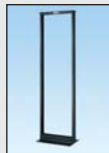

2 NVR12 12" Wide Front and Rear Vertical Manager – 45 RU (page L.74)



3 NRD12 – Dual Hinged Door Available in 6", 10" and 12" widths (page L.74)



4 WMPV45ERTW – Rack Top Trough with Waterfall creates pathway above rack, for use with R2P (page L.74)



5 NREP (shown) – End Panel for NRV12, NRV10, NVR6 (page L.74)



6 CMPH2 – 2 RU Open-Access™ Horizontal Cable Manager D-rings installed on panels Front D-ring size 3"H x 3"D Rear D-ring size 3"H x 5"D Width 19" (pages L.81 and L.82)



7 WMPH2E – 2 RU PatchLink™ Horizontal Cable Manager Front pathway 3"H x 3"D Rear pathway 2"H x 5"D Width 20.2" (page L.77)



8 NCMH2 – Net-Manager™ Horizontal Cable Manager (page L.79)



9 NM2 – 2 RU NetManager™ High Capacity Horizontal Cable Manager (page L.78)



10 RFG6X8 – Cool Boot™ Raised Floor Air Sealing Grommet (page L.90 and L.91)



11 R2PPDUB – Power Outlet Unit (POU) Bracket for 2 and 4 post racks (page L.63)



NetRunner™ High Capacity Vertical Cable Managers

- Large finger openings accommodate up to 24 Category 6A cables
- Push button dual hinged doors ordered separately can be opened 110° to the left or right to provide complete access to the cables inside the vertical pathway
- Snap-on cable retainers can be placed on to fingers to help retain cables in channel during installation and maintenance
- Vertical managers include cable retainers, mounting brackets and #12-24 screws
- Zero RU mounting capability expands the functionality of the vertical manager

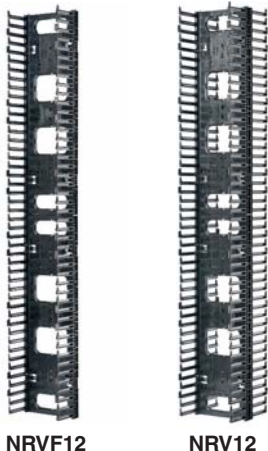

NRVF12

NRV12



NRD12

NREP

Part Number	Part Description	No. of Rack Spaces	Std. Pkg. Qty.	Std. Ctn. Qty.
NRV6	High capacity front and rear vertical manager. Dimensions: 80.4"H x 6.7"W x 13.8"D (2042mm x 170mm x 350mm).	45	1	—
NRV10	High capacity front and rear vertical manager. Dimensions: 80.4"H x 10.0"W x 13.8"D (2042mm x 254mm x 350mm).	45	1	—
NRV12	High capacity front only vertical manager. Dimensions: 80.4"H x 12.0"W x 7.48"D (2042mm x 305mm x 190mm).	45	1	—
NRVF6	High capacity front only vertical manager. Dimensions: 80.4"H x 6.7"W x 7.48"D (2042mm x 170mm x 190mm).	45	1	—
NRVF10	High capacity front only vertical manager. Dimensions: 80.4"H x 10.0"W x 7.48"D (2042mm x 254mm x 190mm).	45	1	—
NRVF12	High capacity front only vertical manager. Dimensions: 80.4"H x 12.0"W x 7.48"D (2042mm x 305mm x 190mm).	45	1	—
NRD6	High capacity dual hinge metal door. Dimensions: 82.8"H x 7.4"W x 1.6"D (2104mm x 188mm x 40mm).	45	1	—
NRD10	High capacity dual hinge metal door. Dimensions: 82.8"H x 10.7"W x 1.6"D (2104mm x 272mm x 40mm).	45	1	—
NRD12	High capacity dual hinge metal door. Dimensions: 82.8"H x 12.7"W x 1.6"D (2104mm x 322mm x 40mm).	45	1	—
NRVCB	NetRunner™ High Capacity Center Mount Bracket Kit allows mounting to adjacent racks. 4 brackets per kit.	—	1	10
NREP	End panel for use with NRV series, WMPVHCF45E/WMPVHC45E. Includes two panel sections to cover 45 RU on one side.	—	1	—
WMPVSMK	NetRunner™ High Capacity Side Mount Hardware Kit for use with R4P 4 post rack series.	—	1	10
WMPV45ERTW	Rack top trough with waterfall creates pathway above rack, for use with SMR19X84 and WMPV45E/WMPVHC45E, NRV.	—	1	—
WR5E-X	Snap-on finger cable retainers.	—	10	100
PRSP5	Molded plastic slack spool, front or rear. Dimensions: 5.25"D x 1.3" dia. (133mm x 32mm)	—	10	100
SRB19BLY	Strain relief bar extends 2" off the rack; supports, manages, and provides proper bend radius protection.	1	1	—

Capacity Chart	Front Channel with Slack Spool					Front Channel with No Slack Spool					Rear Channel					
	Part Number	Channel Area (In ²)	Cable Capacity*				Channel Area (In ²)	Cable Capacity*				Channel Area (In ²)	Cable Capacity*			
			Cat6A-SD (0.240)	Cat6A (0.300)	Cat6 (0.240)	Cat5e (0.225)		Cat6A-SD (0.240)	Cat6A (0.300)	Cat6 (0.240)	Cat5e (0.225)		Cat6A-SD (0.240)	Cat6A (0.300)	Cat6 (.240)	Cat5e (.225)
NRV6 (front/rear)	23.3	180	115	180	205	32.9	254	163	254	289	32.9	254	163	254	289	
NRVF6 (front only)	23.3	180	115	180	205	32.9	254	163	254	289	—	—	—	—	—	
NRV10 (front/rear)	42.8	331	212	331	377	52.4	406	260	406	461	52.4	406	260	406	461	
NRVF10 (front/only)	42.8	331	212	331	377	52.4	406	260	406	461	—	—	—	—	—	
NRV12 (front/rear)	54.6	422	270	422	481	64.2	497	318	497	565	64.2	497	318	497	565	
NRVF12 (front only)	54.6	422	270	422	481	64.2	497	318	497	565	—	—	—	—	—	

*Capacities are based on a fill ratio of 35% to accommodate proper cable routing techniques. For 50% fill ratio, multiply by 1.5. All dimensions represent typical outer cable diameter in inches.

NetRunner™ Vertical Cable Management

- Large finger openings accommodate up to 24 Category 6 cables
- Integral cable retainers on the end of each finger to help contain cables within each rack unit
- Bend radius fingers align with rack spaces to support cables as they transition to the vertical pathway
- Dual hinged covers can be opened 110° to the left or right to provide complete access to the cables inside the vertical pathway
- Snap-on cable retainers can be placed on to fingers to help retain cables in channel during installation and maintenance
- Vertical managers include hinged covers, cable retainers, mounting brackets and #12-24 screws



Part Number	Part Description	No. of Rack Spaces [^]	Std. Pkg. Qty.	Std. Ctn. Qty.
Vertical Cable Managers – Front and Rear				
WMPV22E	Front and rear vertical manager. Dimensions: 41.5"H x 4.9"W x 12.0"D (1054mm x 125mm x 306mm)	22	1	—
WMPVHC45E	Front and rear vertical manager. Dimensions: 83.0"H x 6.7"W x 14.1"D (2108mm x 170mm x 357mm)	45	1	—
WMPV45E	Front and rear vertical manager. Dimensions: 83.0"H x 4.9"W x 12.0"D (2108mm x 125mm x 306mm)	45	1	—
Vertical Cable Managers – Front Only				
WMPVF22E	Front only vertical manager. Dimensions: 41.5"H x 4.9"W x 6.5"D (1054mm x 125mm x 165mm)	22	1	—
WMPVHCF45E	Front only vertical manager. Dimensions: 83.0"H x 6.7"W x 7.6"D (2108mm x 170mm x 192mm)	45	1	—
WMPVF45E	Front only vertical manager. Dimensions: 83.0"H x 4.9"W x 6.5"D (2108mm x 125mm x 165mm)	45	1	—
Accessories				
WMPVCBE	NetRunner™ Center Mount Bracket Kit allows mounting to adjacent racks. Four brackets per kit.	—	1	10
WMPVSMK	NetRunner™ Side Mount Hardware Kit for use with Panduit CMR19X84S racks and Panduit R4P 4 post rack series.	—	1	10
WMPVCMB	Rack adapter bracket kit. Front or back mounted on racks with dimensions up to 1 5/8" (41.1mm) from outside edge of rack to center of the mounting hole. Two kits are required for center mounting of NetRunner™ Managers. Four brackets per kit.	—	1	10
NREP	End panel for use with NRV series, WMPVHCF45E/WMPVHC45E. Includes two panel sections to cover 45 RU on one side.	—	1	—
WMPV45EP	End panel for use with WMPV45E. Includes two panel sections to cover 45 RU on one side.	—	1	—
WMPV45ERTW	Rack top trough with waterfall creates pathway above rack, for use with CMR19X84 and WMPV45E/WMPVHC45E and NRV series.	—	1	—
WR5E-X	Snap-on finger cable retainers.	—	10	100

[^]One rack space = 1.75" (44.45mm).
All product color is black.

Part Number	Cat6A-SD (.240")		Cat 6A (.300")		Cat6 (.240")		Cat5e (.225")	
	Front	Rear	Front	Rear	Front	Rear	Front	Rear
WMPV22E	143	143	91	143	143	143	162	162
WMPVF22E	143	—	91	—	143	—	162	—
WMPV45E	143	143	91	143	143	143	162	162
WMPVF45E	143	—	91	—	143	—	162	—
WMPVHC45E	266	266	170	266	266	266	303	303
WMPVHCF45E	266	—	170	—	266	—	303	—

Note: Capacities are based upon a fill rate of 35% to accommodate proper cable routing techniques.
For comparison, multiply by 1.5 for a fill rate of 50%.

Horizontal Cable Management Rack Systems

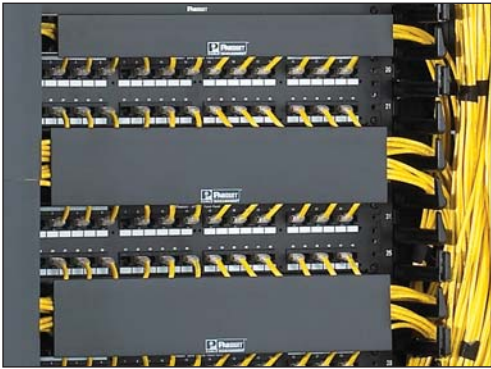

- Panduit® PatchLink™, NetManager™, and Open-Access™ Horizontal Cable Managers manage, protect, and showcase cables between patch panels on 19" EIA racks
- PatchLink™ and NetManager™ Dual Hinged Covers conceal cable pathway and provide easy access without having to remove the door
- Pass-through holes allow front to rear cabling
- For comparison, multiply by 1.25 for a fill rate of 50%
- Capacities are based on a fill rate of 40% to accommodate proper cable routing techniques

PatchLink™ Horizontal Cable Manager



Cable Capacity Chart				
Part Number	Cat 6 (.240")		Cat 5e (.225")	
	Front	Back	Front	Back
WMP1E	60	80	66	90
WMPF1E	60	—	66	—
WMPFSE	24	—	30	—
WMPH2E	60	66	66	66
WMPHF2E	60	—	66	—
WMPLFSE	12	—	16	—
WMPLSE	12	12	16	44
WMPSE	24	25	30	44

NetManager™ High Capacity Horizontal Cable Manager



Cable Capacity Chart										
Part Number	Cat 6A-SD (.240")		Cat 6A (.300")		Cat 6 (.240")		Cat5e (.225")		Fiber (3mm)	
	Front	Back	Front	Back	Front	Back	Front	Back	Front	Back
NM1	30	30	18	18	30	30	34	34	120	120
NM2	84	84	54	54	84	84	96	96	348	348
NM3	144	144	90	90	144	144	168	168	618	618
NM4	210	210	132	132	210	210	240	240	882	882
NMF1	30	—	18	—	34	—	34	—	120	—
NMF2	84	—	54	—	96	—	96	—	348	—
NMF3	144	—	90	—	168	—	168	—	618	—
NMF4	210	—	132	—	240	—	240	—	882	—

NetManager™ Horizontal Cable Manager

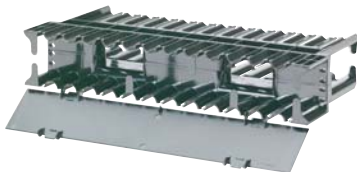

Cable Capacity Chart						
Part Number	Cat. 6 (.240")		Cat. 5e (.255")		Fiber (3mm)	
	Front	Back	Front	Back	Front	Back
NCMH2	54	66	60	78	220	352
NCMHF2	54	—	60	—	220	—
NCMHF1	24	—	24	—	88	—

Open-Access™ Horizontal Cable Manager



Cable Capacity Chart						
Part Number	Cat. 6 (.240")		Cat. 5e (.255")		Fiber (3mm)	
	Front	Back	Front	Back	Front	Back
CMPH1	24	26	26	30	88	108
CMPH2	52	96	46	98	203	392
CMPHF1	24	—	24	—	88	—
CMPHHF1	24	—	30	—	107	—
CMPHF2	54	—	60	—	208	—
CMPHH2	96	—	108	—	392	—

All dimensions represent typical outer cable diameter in inches (mm).

PatchLink™ Horizontal Cable Managers

- Lightweight plastic construction provides durability and easy installation
- Patented dual hinged cover allows cable access without removing cover
- Rounded edges on fingers protect cables from snags and damage to cable
- Flexible fingers allows easy installation and removal of cables
- Increased finger spacing provides larger area for high performance Category 6 cables
- Pass-through holes allow front to rear cabling
- Mount to standard 19" EIA racks and cabinets
- Covers, #12-24 and M6 mounting screws included



WMPSE



WMP1E



WMPH2E



WMPFSE



WMPHFSE



WMPF1E



WMPHF2E

Part Number	Part Description	No. of Rack Spaces [^]	Std. Pkg. Qty.
19" Manager, Front and Rear, 1 RU			
WMPLESE	1.7"H x 19.0"W x 7.9"D (44mm x 483mm x 200mm).	1	1
WMPSE	1.7"H x 19.0"W x 8.9"D (44mm x 483mm x 226mm).	1	1
WMPSE-X	1.7"H x 19.0"W x 8.9"D (44mm x 483mm x 226mm). Package of 10.	1	10
19" Manager, Front and Rear, 2 RU			
WMP1E	3.5"H x 19.0"W x 8.9"D (89mm x 483mm x 226mm).	2	1
WMP1E-V	3.5"H x 19.0"W x 8.9"D (89mm x 483mm x 226mm). Package of 5.	2	5
WMPH2E	3.5"H x 20.2"W x 8.9"D (89mm x 513mm x 226mm). Includes extended front covers and two bend radius clips.	2	1
19" Manager, Front Only, 1 RU			
WMPFSE	1.7"H x 19.0"W x 3.7"D (44mm x 483mm x 94mm).	1	1
WMPFSE-E	1.7"H x 19.0"W x 3.7"D (44mm x 483mm x 94mm). Package of 20.	1	20
WMPLEFSE	1.7"H x 19.0"W x 2.7"D (44mm x 483mm x 69mm).	1	1
19" Manager, Front Only, 2 RU			
WMPF1E	3.5"H x 19.0"W x 3.7"D (89mm x 483mm x 94mm).	2	1
WMPF1E-X	3.5"H x 19.0"W x 3.7"D (89mm x 483mm x 94mm). Package of 10.	2	10
WMPHF2E	3.5"H x 20.2"W x 3.7"D (89mm x 573mm x 94mm). Includes extended front covers and two bend radius clips.	2	1

[^]One rack space = 1.75" (44.45mm).
All product color is black.

NetManager™ High Capacity Horizontal Cable Managers

- Innovative inset fingers slope inward toward back of managers offering unobstructed access to network cabling for easier moves, adds, and changes
- Large front finger openings easily accommodate Category 6 and 10 GbE cables, speeding installation and reducing maintenance costs
- Rear cable management finger spacing utilizes open D-rings for greater accessibility
- Can be used to create large capacity horizontal pathways for routing cable
- Patented front and rear dual hinged cover allows cable access without removing cover
- Curved surfaces maintain cable bend radius
- Pass-through holes allow for front to rear cabling
- Built in cable retainers hold cable in place for easy moves, adds, and changes
- Mount to 19" EIA racks and cabinets
- Covers, #12-24 and M6 mounting screws included
- Design fits flush to the front of the NetRunner® High Capacity WMPVHCF45E and WMPVHC45E Vertical Managers



NM2



NMF2



NMF3



NMF4



NM1B



NM2B



NM3B



NM4B

Part Number	Part Description	No. of Rack Spaces [^]	Std. Pkg. Qty.
19" High Capacity Manager, Front and Rear			
NM1	Horizontal Cable Manager High Capacity Front and Rear 1 Rack Unit. 1.7"H x 19.0"W x 13.1"D (44mm x 482mm x 332mm).	—	1
NM2	Horizontal Cable Manager High Capacity Front and Rear 2 Rack Units. 3.5"H x 19.0"W x 13.1"D (88mm x 482mm x 332mm).	—	1
NM3	Horizontal Cable Manager High Capacity Front and Rear 3 Rack Units. 5.2"H x 19.0"W x 13.1"D (133mm x 482mm x 332mm).	—	1
NM4	Horizontal Cable Manager High Capacity Front and Rear 4 Rack Units. 7.0"H x 19.0"W x 13.1"D (177mm x 482mm x 332mm).	—	1

19" High Capacity Manager, Front Only			
NMF1	Horizontal Cable Manager High Capacity Front Only 1 Rack Unit. 1.7"H x 19.0"W x 6.2"D (44mm x 482mm x 157mm).	1	1
NMF2	Horizontal Cable Manager High Capacity Front Only 2 Rack Units. 3.5"H x 19.0"W x 6.2"D (88mm x 482mm x 157mm).	2	1
NMF3	Horizontal Cable Manager High Capacity Front Only 3 Rack Units. 5.2"H x 19.0"W x 6.2"D (133mm x 482mm x 157mm).	3	1
NMF4	Horizontal Cable Manager High Capacity Front Only 4 Rack Units. 7.0"H x 19.0"W x 6.2"D (177mm x 482mm x 157mm).	4	1

Accessories			
NM1B	Front to rear pass through blanking panel for NetManager™ High Capacity Horizontal Cable Managers, NM1 and NMF1.	—	1
NM2B	Front to rear pass through blanking panel for NetManager™ High Capacity Horizontal Cable Managers, NM2 and NMF2.	—	1
NM3B	Front to rear pass through blanking panel for NetManager™ High Capacity Horizontal Cable Managers, NM3 and NMF3.	—	1
NM4B	Front to rear pass through blanking panel for NetManager™ High Capacity Horizontal Cable Managers, NM4 and NMF4.	—	1

[^]One rack space = 1.75" (44.5mm).
All product color is black.

NetManager® Horizontal Cable Managers

- Patented design
- Lightweight plastic construction provides durability and easy installation
- Removable front cover hinges 180° up or down to allow access without removing cover
- Curved surfaces maintain cable bend radius
- Pass-through holes allow for front to rear cabling
- Built in cable retainers hold cable in place for easy moves, adds, and changes
- Mount to 19" EIA racks and cabinets
- Covers, #12-24 and M6 mounting screws included



NCMHF1



NCMH2

Part Number	Part Description	No. of Rack Spaces [^]	Std. Pkg. Qty.
NCMHF1	1.7"H x 19.0"W x 3.7"D (44mm x 483mm x 95mm).	1	1
NCMHF2	3.5"H x 19.0"W x 3.7"D (88mm x 483mm x 95mm).	2	1
NCMH2	3.5"H x 19.0"W x 9.8"D (88mm x 483mm x 248mm). Snap-on rear cover.	2	1

[^]One rack space = 1.75" (44.45mm).
All product color is black.

PatchRunner™ High Capacity Horizontal Cable Managers

- Manage cables on switches with vertical cards
- Curved cable management fingers support cables as they transition to the vertical pathway
- Can be used to create cable pathways for routing cable
- Steel hinged cover provides easy access to pathway
- Pass-through holes on top and back of manager
- Mount to 19" EIA racks and cabinets
- Mounting hardware included

**PEHF2****PEHF3****PEHF4**

Part Number	Part Description	No. of Rack Spaces [^]	Cable Capacity					Std. Pkg. Qty.
			Cat 6A-SD (.240")	Cat 6A (.300")	Cat 6 (.240")	Cat 5e (.225")	Fiber (3mm)	
PEHF2	PatchRunner™ High Capacity Horizontal Cable Manager with hinged cover, front only, 2 RU. Dimensions: 3.5"H x 18.9"W x 9.8"D* (89mm x 480mm x 250mm*) *Depth can telescope from rack mounting face 4.4" (112mm) to 7.6" (193mm).	2	143	92	143	163	592	1
PEHF3	PatchRunner™ High Capacity Horizontal Cable Manager with hinged cover, front only, 3 RU. Dimensions: 5.2"H x 18.9"W x 9.8"D* (133mm x 480mm x 250mm*) *Depth can telescope from rack mounting face 4.4" (112mm) to 7.6" (193mm).	3	259	166	259	295	1072	1
PEHF4	PatchRunner™ High Capacity Horizontal Cable Manager with hinged cover, front only, 4 RU. Dimensions: 7.0"H x 18.9"W x 9.8"D* (177mm x 480mm x 250mm*) *Depth can telescope from rack mounting face 4.4" (112mm) to 7.6" (193mm).	4	375	240	375	427	1551	1

[^]One rack space = 1.75" (44.45mm).
All product color is black.

Open-Access™ Horizontal Cable Managers

- D-ring managers provide an open and efficient way to manage cable
- Patented D-ring design provides flexibility for easy moves, adds, and changes
- Optional snap-on cover
- Pass-through holes allow front to rear cabling
- Mount to 19" EIA racks and cabinets
- Hardware included



CMPH1



CMPH2



CMPHF1



CMPHHF1



CMPHF2



CMPHH2

Part Number	Part Description	No. of Rack Spaces [^]	Std. Pkg. Qty.
19" Manager, Front and Rear, 1 RU			
CMPH1	D-rings installed on panels. 1.7"H x 19.0"W x 8.6"D (44mm x 483mm x 218mm).	1	1
19" Manager, Front and Rear, 2 RU			
CMPH2	D-rings installed on panel. 3.5"H x 19.0"W x 8.6"D (88mm x 483mm x 218mm).	2	1
19" Manager, Front Only, 1 RU			
CMPHF1	D-rings installed on panel. 1.7"H x 19.0"W x 3.4"D (44mm x 483mm x 87mm).	1	1
CMPHHF1	D-rings installed on panel. 1.7"H x 19.0"W x 5.7"D (44mm x 483mm x 144mm).	1	1
19" Manager, Front Only, 2 RU			
CMPHF2	D-rings installed on panel. 3.5"H x 19.0"W x 3.4"D (88mm x 483mm x 87mm).	2	1
CMPHH2	D-rings installed on panel. 3.5"H x 19.0"W x 5.7"D (88mm x 483mm x 144mm).	2	1
Optional Covers			
CMPH1C	Snap-on cover for 1 RU D-ring panels. Width 19.4" (492mm).	1	1
CMPH2C	Snap-on cover for 2 RU D-ring panels. Width 19.4" (492mm).	2	1

[^]One rack space = 1.75" (44.45mm).
All product color is black.

PATENTED Vertical D-Rings

- Patented cable manager ring
- Standard EIA hole spacing allows product to be mounted to any standard rack
- Flexible material allows arm to rotate so entire cable bundle can be inserted and removed
- Rounded edges prevent damage to cable insulation
- 1/4" (M6) mounting hole allows for a variety of screws to secure the D-ring to a surface
- Create a structured pathway and allows for open access
- Material: Black Flame Retardant Polycarbonate



Part Number	Part Description	Cable Capacity			Std. Pkg. Qty.
		Cat 6A (0.300")	Cat 6 (0.240")	Cat 5e (0.225")	
CMVDR1	Vertical D-ring. Outside dimensions 5.72"L x 2.05"W (145.3mm x 52.1mm).	40	62	70	1
CMVDR1S	Vertical D-ring. Outside dimensions 3.26"L x 2.05"W (82.8mm x 52.1mm).	20	30	35	1
CMVDR2	Vertical D-ring. Outside dimensions 5.72"L x 3.30"W (145.3mm x 83.8mm).	82	128	144	1
CMVDR2S	Vertical D-ring. Outside dimensions 3.26"L x 3.30"W (82.8mm x 83.8mm).	40	62	70	1
CMVDRC	Center mounted vertical D-ring for routing cables between two adjacent racks. Requires 8.25" spacing between the center lines of the adjacent rack's mounting holes. Outside dimensions 5.66"L x 8.75"W (143.8mm x 222.3mm).	170	265	300	1

Cable Routing Troughs

- Provide pathways to route cables in a rack line-up



Part Number	Part Description	Cable Capacity					Std. Pkg. Qty.
		Cat. 6A (.298")	Cat. 6A (.289")	Cat. 6 (.250")	Cat. 5e (.187")	Fiber (3mm)	
CMLT19	4 RU lower trough with 1.3" bend radius mounts to the bottom of a standard 19" EIA rack. Dimensions: 8.0"H x 19.0"W x 4.5"D (203mm x 483mm x 114mm).	85	106	125	224	564	1
CMUT19	2 RU upper trough with 1.3" bend radius mounts to the top of a standard 19" EIA rack. Dimensions: 3.5."H x 19.0"W x 4.5"D (89mm x 483mm x 114mm).	57	70	83	148	373	1
CMT4	4 RU cable routing trough. Dimensions: 6.9"H x 19.0"W x 4.5"D (176mm x 483mm x 114mm).	152	12488	223	399	1002	1

One rack space = 1.75" (44.45mm).
 All product color is black.
 All dimensions represent typical outer cable diameter in inches (mm).

Rack Mount Shelves

- Load ratings up to 250 lbs. refer to part descriptions for specific load ratings

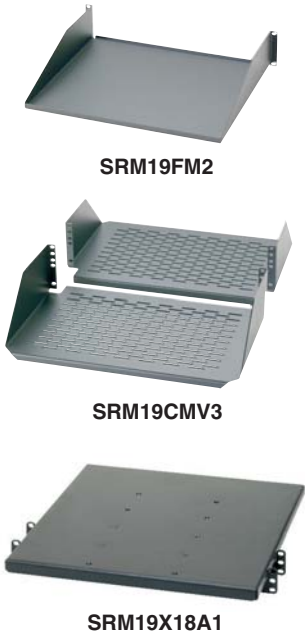

Part Number	Part Description	No. of Rack Spaces [^]	Std. Pkg. Qty.
SRM19FM1	19" front mount shelf, steel. Dimensions: 1.7"H x 19.0"W x 15.2"D (44mm x 483mm x 385mm). Load rating 30 lbs.	1	1
SRM19FM2	19" front mount shelf, steel. Dimensions: 3.5"H x 19.0"W x 15.2"D (88mm x 483mm x 385mm). Load rating 50 lbs.	2	1
SRM19CMV3	19" cantilevered shelf, vented aluminum. Includes two-piece shelf that mounts to front and back of EIA racks. Dimensions: 5.2"H x 19.2"W x 12.5"D (133mm x 489mm x 316mm). Load rating 200 lbs.	3	1
SRM19CM3	19" cantilevered shelf, aluminum. Includes two-piece shelf that mounts to front and back of EIA racks. Dimensions: 5.2"H x 19.2"W x 12.5"D (133mm x 489mm x 316mm). Load rating 200 lbs.	3	1
SRM19X18A1	19" adjustable mount shelf, steel, mounts to front and back of EIA racks. Dimensions: 1.8"H x 19.0"W x 18.0"D (44mm x 483mm x 457mm). Load rating 250 lbs.	1	1
SRM19X25A1	19" adjustable mount shelf, steel, mounts to front and back of EIA racks. Dimensions: 1.8"H x 19.0"W x 25.0"D (44mm x 483mm x 635mm). Load rating 250 lbs.	1	1

[^]One rack space = 1.75" (44.45mm).
All product color is black.

Panel Extender Brackets

- Allow for mounting 19" product on 23" standard EIA racks or cabinets
- Offset bracket design maintains flush mounting of panels
- Mounting hardware included



Part Number	Part Description	No. of Rack Spaces [^]	Std. Pkg. Qty.	Std. Ctn. Qty.
PEB1	Converts 19" horizontal panels to 23" panels.	1	1	10
PEB2	Converts 19" horizontal panels to 23" panels.	2	1	10

[^]One rack space = 1.75". (44.45mm).
All product color is black.

Rack Mount Cable Management Accessories

- Bend radius control fingers support cables as they transition to the vertical pathway
- Finger spacing aligns with rack units
- Attach to patch panels or equipment mounting screws
- Lightweight plastic construction provides durability and easy installation

**CMBRC1****CMBRC5E**

Part Number	Part Description	No. of Rack Spaces [^]	Std. Ctn. Qty.
CMBRC1	Kit of two bend radius control fingers; for use with patch panels. Maintains 1/2" bend radius control. Dimensions: 1.7"H x .8" W x 3.0"D (44mm x 19mm x 77mm).	1	10
CMBRC1E	Kit of two bend radius control fingers, for use with patch panels. Maintains 1/2" bend radius control. Dimensions: 1.7"H x 1.0"W x 5.1"D (44mm x 25mm x 129mm).	1	10
CMBRC5	One-piece unit with five bend radius control fingers; for use with active equipment. Maintains 1/4" bend radius control. Dimensions: 8.7"H x 1.0"W x 3.3"D (222mm x 26mm x 84mm).	5	10
CMBRC5E	One-piece unit with five bend radius control fingers; for use with active equipment. Maintains 1/4" bend radius control. Dimensions: 8.7"H x 1.0"W x 5.1"D (222mm x 26mm x 129mm).	5	10

[^]One rack space = 1.75" (44.45mm).
All product color is black.

Hinged Wall Brackets

- Mount to wall or standard EIA 19" rack
- Cable tie slots
- Standard 19" EIA hole spacing
- Panel rotates from one side for easy access to cabling
- Include write-on labeling area
- Accept 19" patch panels, horizontal managers, and equipment

**WBH1****WBH2****WBH3****WBH4****WBH4E**

Part Number	Part Description	No. of Rack Spaces [^]	Std. Pkg. Qty.
6" Deep Wall Brackets			
WBH1	Dimensions: 1.8"H x 20.2"W x 6.3"D (44mm x 513mm x 159mm). Load rating 10 lbs.	1	1
WBH2	Dimensions: 3.5"H x 20.2"W x 6.3"D (89mm x 513mm x 159mm). Load rating 20 lbs.	2	1
WBH3	Dimensions: 5.3"H x 20.2"W x 6.3"D (133mm x 513mm x 159mm). Load rating 30 lbs.	3	1
WBH4	Dimensions: 7.0"H x 20.2"W x 6.3"D (178mm x 513mm x 159mm). Load rating 40 lbs.	4	1
15" Deep Wall Brackets			
WBH2E	Dimensions: 3.5"H x 20.4"W x 15.8"D (89mm x 519mm x 402mm). Load rating 20 lbs.	2	1
WBH4E	Dimensions: 7.0"H x 20.4"W x 15.8"D (177mm x 519mm x 402mm). Load rating 40 lbs.	4	1
WBH6E	Dimensions: 10.5"H x 20.4"W x 15.8"D (267mm x 519mm x 402mm). Load rating 60 lbs.	6	1

[^]One rack space = 1.75" (44.45mm).
All product color is black.

Full-Length Blanking Shade

- Adjustable blanking solution that can blank out as few as 4 or as many as 45 rack units
- Requires no tools or hardware to install
- Easy and efficient installation and deployment
- Can easily be raised or lowered to allow service to components within the cabinet



Part Number	Part Description	No. of Rack Spaces	Std. Pkg. Qty.
FLBSIM-Y	Full-length blanking shade blanks out 4-45 consecutive rack units on standard 19.00" (482.6mm) wide vertical mounting rails; black.	4-45	1

Tool-Less Blanking Panels

- Minimize bypass airflow in standard EIA 19" racks and cabinets while providing an aesthetic appearance
- Require no tools or hardware to install



TLBP1



TLBP2

Part Number	Part Description	No. of Rack Spaces [^]	Std. Pkg. Qty.
TLBP1S-V	19" (483mm) width for 3/8" cage nut holes (may be used with or without cage nuts installed). 1 RU.	1	5
TLBP2S-V	19" (483mm) width for 3/8" cage nut holes (may be used with or without cage nuts installed). 2 RU.	2	5
TLBP1R-V	19" (483mm) width for tapped rails. 1 RU.	1	5
TLBP2R-V	19" (483mm) width for tapped rails. 2 RU.	2	5

[^]One rack space = 1.75" (44.45mm).
All product color is black.

Rack Filler Panels

- Reserve rack space for future use
- Direct airflow in cabinet applications
- Mount to standard EIA 19" racks or cabinets
- #12-24 and M6 mounting screws included



DPFP1



DPFP2



DPFP4



DPFP8



DPFPA1

Part Number	Part Description	No. of Rack Spaces [^]	Std. Pkg. Qty.	Std. Ctn. Qty.
DPFP1	Dimensions: 1.8"H x 19.0"W (44mm x 483mm).	1	1	10
DPFP2	Dimensions: 3.5"H x 19.0"W (89mm x 483mm).	2	1	10
DPFP4	Dimensions: 7.0"H x 19.0"W (178mm x 483mm).	4	1	10
DPFP8	Dimensions: 14.0"H x 19.0"W (355mm x 483mm).	8	1	10
DPFPA1	1RU adjustable blanking panel.	—	1	10

[^]One rack space = 1.75" (44.45mm).
All product color is black.



Angled Panel Accessories

- Aesthetic design provides a clean and consistent look when used with Panduit angled patch panels
- Support warm aisle/cold aisle methodology by sealing in cool air and not allowing it to escape, promoting proper airflow and cooling
- Protect exposed connectors from intrusion of debris or accidental disconnection



CPAF1BLY



CPAF2BLY



CPATCBL

Part Number	Part Description	No. of Rack Spaces [^]	Std. Pkg. Qty.	Std. Ctn. Qty.
CPAF1BLY	Covers one open rack space in standard EIA 19" rack.	1	1	10
CPAF2BLY	Covers two open rack spaces in standard EIA 19" rack.	2	1	10
CPATCBL	Transitional cover for angled patch panels that occupies zero rack space.	0	1	10

[^]One rack space = 1.75" (44.45mm).
All product color is black.

IN-Cabinet Vertical Cable Managers

- For managing cable within cabinets 27" or wider
- Attach to equipment mounting rails
- Two mounting bracket options to facilitate mounting to various cabinet configurations
- Snap-on covers included



Front Mount Bracket



Side Mount Bracket



CWMPV3340

Part Number	Part Description	No. of Rack Spaces [^]	Std. Pkg. Qty.
Side Mount – Front Only			
CWMPV3440	Duct with side mount bracket, cage nut, and screws. Dimensions: 71.9"H x 3.5"W x 4.3"D (1825mm x 88mm x 109mm). Capacity: 96 cables .187 dia.	40	1
CWMPV2440	Duct with side mount bracket, cage nut, and screws. Dimensions: 71.9"H x 2.5"W x 4.3"D (1825mm x 63mm x 109mm). Capacity: 60 cables .187 dia.	40	1
Front Mount – Front Only			
CWMPV2340	Duct with front mount bracket, cage nut, and screws. Dimensions: 70.0"H x 3.7"W x 3.3"D (1778mm x 94mm x 83mm). Capacity: 48 cables .187 dia.	40	1
CWMPV3340	Duct with front mount bracket, cage nut, and screws. Dimensions: 70.0"H x 4.7"W x 3.3"D (1778mm x 119mm x 83mm). Capacity: 72 cables .187 dia.	40	1

[^]One rack space = 1.75" (44.45mm).
All product color is black.

Cable Capacity Chart

Part Number	Cat 6 (.240")	Cat 5e (.225")	Fiber (3mm)
CWMPV3440	116	132	386
CWMPV2440	83	74	225
CWMPV2340	94	107	377
CWMPV3340	119	136	479

Communication Cable Management Kit for Cabinets

- Kit of cable management accessories specifically designed for use in a network cabinet or enclosure



Part Number	Part Description	Std. Pkg. Qty.*	Std. Ctn. Qty.
CCMKIT1	Kit includes the following: 1 roll (15' (4.6m) length) .33" (8.4mm) Tak-Ty® Cable Ties 24 nylon cable ties 12 adhesive backed cable tie mounts 6 push style cable tie mounts 4 vertical wire saddles 8 flat Pan-Post® Standoffs for use with std. nylon cable ties	1	100
CCMKIT2	Kit includes the following: 1 roll (15' (4.6m) length) .75" (19.1mm) Tak-Ty® Cable Ties 12 nylon cable ties 6 adhesive backed cable tie mounts 6 adhesive backed mounts for .75" (19.1mm) Tak-Ty® Cable Ties 6 screw mounts for .75" (19.1mm) Tak-Ty® Cable Ties 4 vertical wire saddles 6 flat Pan-Post® Standoffs for use with .75" (19.1mm) Tak-Ty® Cable Ties	1	100

*Order the number of kits required.

Flat Pan-Post™ Standoffs

- Standard EIA hole spacing allows product to be mounted with user supplied screws up to 1/4" (M6) diameter
- Organize cables in standard cabinets and racks
- Use where space is limited
- For indoor use only
- Material: Natural Nylon 6.6

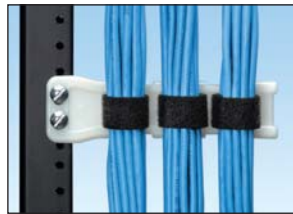

Part Number	Part Description	Std. Pkg. Qty.	Std. Ctn. Qty.
Flat Pan-Post™ Standoff for Nylon Cable Ties			
PPF2S-S25-V	Nylon 6.6 flat Pan-Post™ Standoff. Use with miniature, intermediate, and standard cross section cable ties. Dimensions 5.42"L x 1.50"H x .19"W (137.7mm x 38.1mm x 4.8mm).	5	100
PPF2S-S25-V69	Flame retardant nylon 6.6 flat Pan-Post™ Standoff. Use with miniature, intermediate, and standard cross section cable ties. Material meets UL 94V-0 specifications. Dimensions 5.42"L x 1.50"H x .19"W (137.7mm x 38.1mm x 4.8mm).	5	100
Flat Pan-Post™ Standoff for Tak-Ty® Hook & Loop Cable Ties			
PPF2SV-S25-V	Nylon 6.6 flat Pan-Post™ Standoff. Use with Tak-Ty® Hook & Loop Cable Ties. Dimensions 5.60"L x 1.62"H x .19"W (142.2mm x 41.3mm x 4.8mm).	5	100
PPF2SV-S25-V69	Flame retardant nylon 6.6 flat Pan-Post™ Standoff. Use with Tak-Ty® Hook & Loop Cable Ties. Material meets UL 94V-0 specifications. Dimensions 5.60"L x 1.62"H x .19"W (142.2mm x 41.3mm x 4.8mm).	5	100

Pan-Post[®] Standoffs

- Support cable bundles above or away from surface
- For indoor use only
- Material: Natural Nylon 6.6



Part Number	Part Description	Std. Pkg. Qty.	Std. Ctn. Qty.
PP1S-S10-X	Pan-Post™ Standoff, mounting method #10/M5 screw, 1.06"L x .72"W x 1.97"H (26.9mm x 18.3mm x 50.0mm). Used with cable ties M,I,S.	10	100
PP1S-S12-X	Pan-Post™ Standoff, mounting method #12/M5.5 screw, 1.06"L x .72"W x 1.97"H (26.9mm x 18.3mm x 50.0mm). Used with cable ties M,I,S.	10	100
PP2S-S10-X	Pan-Post™ Standoff, mounting method #10/M5 screw, 1.06"L x .72"W x 4.60"H (26.9mm x 18.3mm x 116.9mm). Used with cable ties M,I,S.	10	100
PP2S-S12-X	Pan-Post™ Standoff, mounting method #12/M5.5 screw, 1.06"L x .72"W x 4.60"H (26.9mm x 18.3mm x 116.9mm). Used with cable ties M,I,S.	10	100

Cable tie cross section sizes: M = Miniature, I = Intermediate, S = Standard.

Bundle Retainers

- Support cable in vertical or horizontal configurations
- Spring fingers with large lead-in facilitates insertion of cable bundles
- Adhesive backed and screw applied versions available
- Material: Black Nylon 6.6



BR2-1.3-A

Part Number	Part Description	Std. Pkg. Qty.	Std. Ctn. Qty.
BR2-1.3	Standard EIA hole spacing for mounting. Maximum bundle capacity: 2.00" (50.8mm).	1	10
BR2-1.3-A	Adhesive base and standard EIA hole spacing provides mounting options. Maximum bundle capacity: 2.00" (50.8mm).	1	10

Cable Management Accessories Roadmap

- Organize cable in a variety of applications providing a standards compliant installation to reduce stress on cable while allowing for easier moves, adds, and changes.

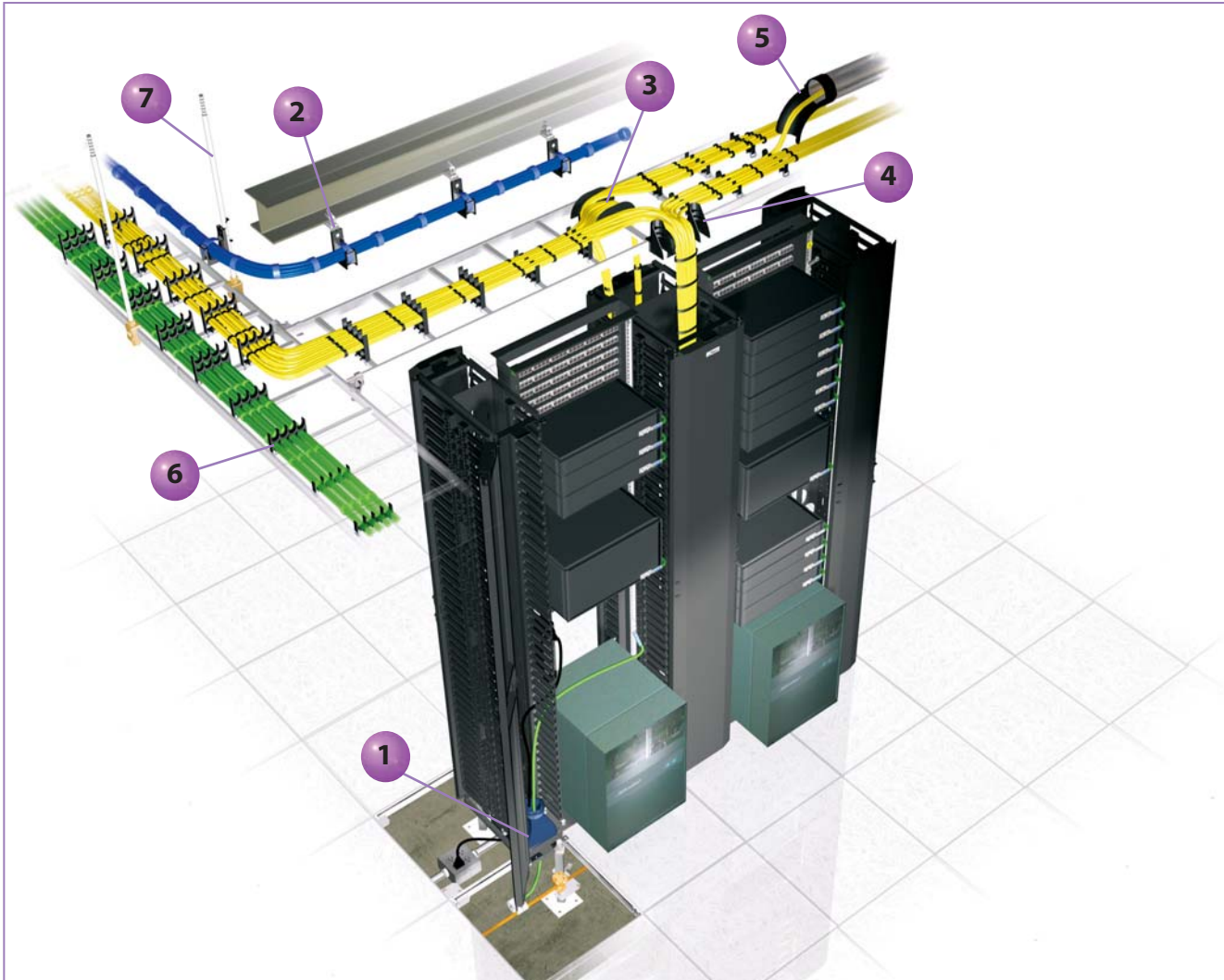

1 Cool Boot® Raised Floor Air Sealing Grommet (pages L.90 and L.91)



2 J-Pro™ Cable Support System (pages L.92 – L.94)



3 Double Waterfall Accessory (page L.99)



4 Waterfall Accessories (pages L.98 and L.99)



5 Conduit Waterfall (page L.98)



6 Stackable Cable Rack Spacers (page L.100)



7 Threaded Rod Cover (page L.99)



PATENTED Cool Boot[®] Raised Floor Air Sealing Grommet

- Airtight fabric minimizes bypass of air through cutouts in the raised floor to improve cooling of network equipment, minimizing the risk of overheating
- Ultra Cinch™ Tie closes top of fabric to prevent air from escaping around cable bundles
- Electrostatic dissipative material provides a pathway to ground reducing the chance of damaging network equipment with electric shock
- Vertical Tak-Ty® Hook & Loop Cable Tie closure system allows for installation on existing cable bundles
- Horizontal Tak-Ty® Hook & Loop Cable Tie closure system allows two or more bundles to be separated in existing or new installations
- Flexible polycarbonate outer ring houses fabric to allow user to secure product to raised floor tile; slit allows outer ring to flex so entire cable bundle can be inserted to allow for retrofit installations even when vertical cable managers are already in place
- Low profile polycarbonate outer ring extends 7/16" (11.1mm) above top of raised floor tile to allow compatibility with vertical cable managers
- Self-tapping #10 screws (included) allow a secure fastening method to top of raised floor tile, also providing a pathway to ground
- Material: Black electrostatic dissipative flame retardant polycarbonate outer ring with navy blue electrostatic dissipative flame retardant fabric
- Manufactured from flame retardant materials



RFG*X*SMY



RFG*X*Y

Part Number	Part Description	Cable Capacity			Std. Pkg. Qty.	Std. Ctn. Qty.
		Cat. 6A (0.300")	Cat. 6 (0.240")	Cat. 5e (0.225")		
Surface Mount						
RFG6X8SMY	Overall size of 6" x 8" (152.4mm x 203.2mm) allows for 4.2" x 6.2" (106.7mm x 157.5mm) capacity.	183	287	326	1	10
RFG8X8SMY	Overall size of 8" x 8" (203.2mm x 203.2mm) allows for 6.2" x 6.2" (157.5mm x 157.5mm) capacity.	271	424	482	1	10
RFG10X8SMY	Overall size of 10" x 8" (254.0mm x 203.2mm) allows for 8.2" x 6.2" (208.3mm x 157.5mm) capacity.	359	561	638	1	10
RFG12X4SMY	Overall size of 12" x 4" (304.8mm x 101.6mm) allows for 10.2" x 2.2" (259.1mm x 55.9mm) capacity.	158	247	281	1	10
RFG12X8SMY	Overall size of 12" x 8" (304.8mm x 203.2mm) allows for 10.2" x 6.2" (259.1mm x 157.5mm) capacity.	447	698	794	1	10
RFG3DSMY	Overall size of 4.8" (121.9mm) diameter allows for 2.7" (68.6mm) diameter capacity.	40	62	71	1	10
RFG5DSMY	Overall size of 6.8" (172.7mm) diameter allows for 4.7" (119.4mm) diameter capacity.	122	191	217	1	10

Integral Mount*

RFG6X8Y	Overall size of 6" x 8" (152.4mm x 203.2mm) allows for 4.2" x 6.2" (106.7mm x 157.5mm) capacity.	183	287	326	1	10
RFG8X8Y	Overall size of 8" x 8" (203.2mm x 203.2mm) allows for 6.2" x 6.2" (157.5mm x 157.5mm) capacity.	271	424	482	1	10
RFG10X8Y	Overall size of 10" x 8" (254.0mm x 203.2mm) allows for 8.2" x 6.2" (208.3mm x 157.5mm) capacity.	359	561	638	1	10
RFG12X4Y	Overall size of 12" x 4" (304.8mm x 101.6mm) allows for 10.2" x 2.2" (259.1mm x 55.9mm) capacity.	158	247	281	1	10
RFG12X8Y	Overall size of 12" x 8" (304.8mm x 203.3mm) allows for 10.2" x 6.2" (259.1mm x 157.5mm) capacity.	447	698	794	1	10
RFG3DY	Overall size of 4.8" (121.9mm) diameter allows for 2.7" (68.6mm) diameter capacity.	40	62	71	1	10
RFG5DY	Overall size of 6.8" (172.7mm) diameter allows for 4.7" (119.4mm) diameter capacity.	122	191	217	1	10

Product complies with Article 645 Section 5(D)(4) of the 2005 National Electrical Code.

Compatible with NetRunner™ and PatchRunner™ Cable Managers, and Panduit® Net-Access™ Cabinets to create a complete cable management system.

*Integral products include a flexible sub-grommet to prevent damage to cable from sharp edges of cut floor tile.

Cool Boot[®] Raised Floor Air Sealing Grommet (continued)

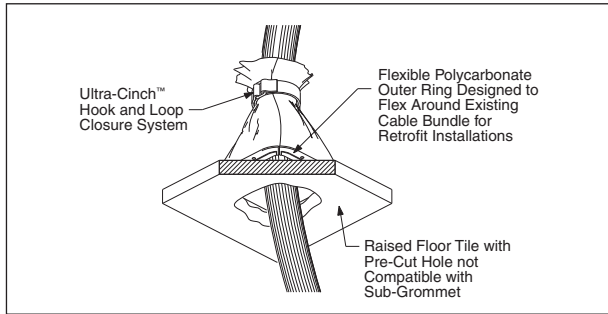

Surface Mount Application

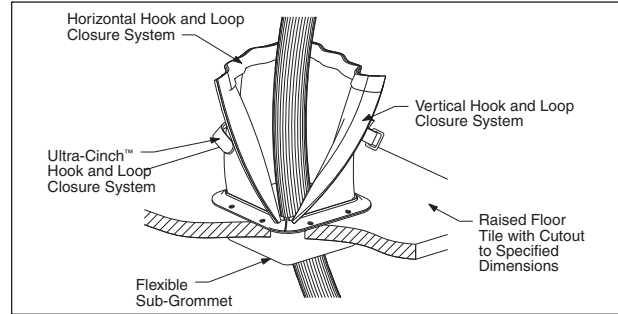

Integral Mount Application



J-Pro™ Cable Support System

- Patented design provides complete horizontal and vertical 1" bend radius control that helps prevent degradation of cable performance
- UL 2043 and CAN/ULC S102.2 listed and suitable for use in air handling spaces
- Pre-rieveted assemblies allow for attachment to walls, ceilings, beams, threaded rods, drop wires and underfloor supports to meet requirements of a variety of applications
- Wide cable support base prevents pinch points that could cause damage to cables
- Cable tie channel allows user to easily install 3/4" (19.1mm) Tak-Ty® Cable Ties to retain cable bundle
- Durable non-metallic J Hook materials provide the ability to manage and support a large number of cables
- Material: Black Nylon 6.6 J Hook with metal attachments



JP2W-L20



JP2WP2-L20



JP2CM-L20



JP2DW-L20

Part Number	Part Description	Max. Bundle Capacity		Max. Cable Capacity			Std. Pkg. Qty.
		In.	mm	Cat 6A (0.300")	Cat 6 (0.240")	Cat 5e (0.225")	
Wall Mount							
JP75W-L20	J Hook for wall mount applications. One 1/4" (M6) mounting hole for user supplied screw. Not for use with powder actuated fasteners.	0.75	19.0	5	8	10	50
JP131W-L20		1.31	33.3	15	25	29	50
JP2W-L20		2.00	50.8	30	46	55	50
JP4W-X20		4.00	101.6	115	180	200	10
Wall Mount with Bracket							
JP75WP2-L20	J Hook for powder actuated installation on walls. One 5/32" (M4) mounting hole and one 1/4" (M6) mounting hole for user supplied fasteners.	0.75	19.0	5	8	10	50
JP131WP2-L20		1.31	33.3	15	25	29	50
JP2WP2-L20		2.00	50.8	30	46	55	50
JP4WP2-X20		4.00	101.6	115	180	200	10
Ceiling Mount							
JP75CM-L20	J Hook with ceiling mount bracket that has one 3/16" (M5), 1/4" (M6), and 3/8" (M10) mounting hole.	0.75	19.0	5	8	10	50
JP131CM-L20		1.31	33.3	15	25	29	50
JP2CM-L20		2.00	50.8	30	46	55	50
JP4CM-X20		4.00	101.6	115	180	200	10
Drop Wire and Threaded Rod Clip							
JP75DW-L20	J Hook with clip for use with #12 wire, threaded rod up to 3/8" (9.5mm) in diameter.	0.75	19.0	5	8	10	50
JP131DW-L20		1.31	33.3	15	25	29	50
JP2DW-L20		2.00	50.8	30	46	55	50

Suitable for use in air handling spaces in accordance with Sec. 300-22(c) and (d) of the National Electrical Code. JP4 family of parts suitable for use in single unit configurations. Listed in accordance with CAN/ULC S102.2 when mounted as single units or in pairs. Minimum spacing of 4 feet (1220mm) required between mount points. (Flame spread rating = 0, Smoke developed classification = 30). All dimensions represent typical outer cable diameter in inches (mm).



J-Pro™ Cable Support System (continued)



JP2SBC50-L20



JP2SBC50R-L20



JP2SBC87-L20



JP2SBC87R-L20



JP2HBC25R-L20

JP2HBC50R-L20

JP2HBC75R-L20

Part Number	Part Description	Max. Bundle Capacity		Max. Cable Capacity			Std. Pkg. Qty.
		In.	mm	Cat 6A (0.300")	Cat 6 (0.240")	Cat 5e (0.225")	
Screw-On Beam Clamps							
JP75SBC50-L20	J Hook with screw-on beam clamp for use with flanges up to 1/2" (12.7mm) thick. Non-rotating mount.	0.75	19.0	5	8	10	50
JP131SBC50-L20		1.31	33.3	15	25	29	50
JP2SBC50-L20		2.00	50.8	30	46	55	50
JP4SBC50-X20		4.00	101.6	115	180	200	10
JP75SBC50R-L20	J Hook with screw-on beam clamp for use with flanges up to 1/2" (12.7mm) thick. Rotates 360 degrees.	0.75	19.0	5	8	10	50
JP131SBC50R-L20		1.31	33.3	15	25	29	50
JP2SBC50R-L20		2.00	50.8	30	46	55	50
JP4SBC50R-X20		4.00	101.6	115	180	200	10
JP75SBC87-L20	J Hook with screw-on beam clamp for use with flanges up to 3/4" (19.1mm) thick. Non-rotating mount.	0.75	19.0	5	8	10	50
JP131SBC87-L20		1.31	33.3	15	25	29	50
JP2SBC87-L20		2.00	50.8	30	46	55	50
JP4SBC87-X20	J Hook with screw-on beam clamp for use with flanges up to 3/4" (19.1mm) thick. Rotates 360 degrees.	4.00	101.6	115	180	200	10
JP75SBC87R-L20		0.75	19.0	5	8	10	50
JP131SBC87R-L20		1.31	33.3	15	25	29	50
JP2SBC87R-L20		2.00	50.8	30	46	55	50
JP4SBC87R-X20	4.00	101.6	115	180	200	10	
Hammer-On Beam Clamps							
JP75HBC25R-L20	J Hook with hammer-on beam clamp for use with flanges 1/8" – 1/4" (3.2mm – 6.4mm) thick. Rotates 360 degrees.	0.75	19.0	5	8	10	50
JP131HBC25R-L20		1.31	33.3	15	25	29	50
JP2HBC25R-L20		2.00	50.8	30	46	55	50
JP4HBC25R-X20		4.00	101.6	115	180	200	10
JP75HBC50R-L20	J Hook with hammer-on beam clamp for use with flanges 5/16" – 1/2" (7.9mm – 12.7mm) thick. Rotates 360 degrees.	0.75	19.0	5	8	10	50
JP131HBC50R-L20		1.31	33.3	15	25	29	50
JP2HBC50R-L20		2.00	50.8	30	46	55	50
JP4HBC50R-X20		4.00	101.6	115	180	200	10
JP75HBC75R-L20	J Hook with hammer-on beam clamp for use with flanges 9/16" – 3/4" (14.3mm – 19.1mm) thick. Rotates 360 degrees.	0.75	19.0	5	8	10	50
JP131HBC75R-L20		1.31	33.3	15	25	29	50
JP2HBC75R-L20		2.00	50.8	30	46	55	50
JP4HBC75R-X20		4.00	101.6	115	180	200	10

Suitable for use in air handling spaces in accordance with Sec. 300-22(c) and (d) of the National Electrical Code. JP4 family of parts suitable for use in single unit configurations. Listed in accordance with CAN/ULC S102.2 when mounted as single units or in pairs. Minimum spacing of 4 feet (1220mm) required between mount points. (Flame spread rating = 0, Smoke developed classification = 30). All dimensions represent typical outer cable diameter in inches (mm).

Table continues on page L.94

cUL[®] LISTED J-Pro™ Cable Support System (continued)



JP2ZP-L20



JP2CP-L20



JP2UF100-L20

Part Number	Part Description	Max. Bundle Capacity		Max. Cable Capacity			Std. Pkg. Qty.
		In.	mm	Cat 6A (0.300")	Cat 6 (0.240")	Cat 5e (0.225")	
Z-Purlin Clips							
JP75ZP-L20	J Hook with z-purlin clip for use with angled flanges up to 1/4" (6.4mm) thick.	0.75	19.0	5	8	10	50
JP131ZP-L20		1.31	33.3	15	25	29	50
JP2ZP-L20		2.00	50.8	30	46	55	50
JP4ZP-X20		4.00	101.6	115	180	200	10
C-Purlin Clips							
JP75CP-L20	J Hook with c-purlin clip for use with vertical flanges up to 1/4" (6.4mm) thick.	0.75	19.0	5	8	10	50
JP131CP-L20		1.31	33.3	15	25	29	50
JP2CP-L20		2.00	50.8	30	46	55	50
JP4CP-X20		4.00	101.6	115	180	200	10
Underfloor Pedestal Support Clamp							
JP75UF100-L20	J Hook with underfloor clamp for use with pedestal support 7/8" square or 1 1/8" – 1 3/8" in diameter.	0.75	19.0	5	8	10	50
JP131UF100-L20		1.31	33.3	15	25	29	50
JP2UF100-L20		2.00	50.8	30	46	55	50
JP4UF100-X20		4.00	101.6	115	180	200	10

Suitable for use in air handling spaces in accordance with Sec. 300-22(c) and (d) of the National Electrical Code. JP4 family of parts suitable for use in single unit configurations. Listed in accordance with CAN/ULC S102.2 when mounted as single units or in pairs. Minimum spacing of 4 feet (1220mm) required between mount points. (Flame spread rating = 0, Smoke developed classification = 30). All dimensions represent typical outer cable diameter in inches (mm).

Metal Stud Grommets and Accessories

- Metal stud grommets and cable support manager support and protect cable within the building structure
- Metal Stud Punching Tool punches a 1-11/32" (34.1mm) round hole in 25 GA. min. to 20 GA max. mild steel studs; contoured handle; lightweight aluminum head; automatic hole centering on standard width (3.625") studs; replaceable punch and dies; self-stripping design that eliminates punch hang-ups



MSG-1.3-C



MSGV-1.3-C



MSPT-1.3



CSM-1.25-C

Part Number	Part Description	Std. Pkg. Qty.	Std. Ctn. Qty.
MSG-1.3-C	Metal stud grommet, 1-11/32" hole.	100	1000
MSGV-1.3-C	Metal stud grommet, 1-11/32" hole, anti-vibration for 1/2" to 1" pipe.	100	1000
MSPT-1.3	Metal stud punch tool with contoured handle for increased leverage.	1	0
CSM-1.25-C	Cable stud manager for 1.25" cable spacing.	100	1000

Color Option Chart

Base Part Number	Black	Red	Blue	White	Green	Orange
JP75W	-L20	-L2			-L5	-L3
JP75WP2	-L20					
JP75CM	-L20	-L2				
JP75DW	-L20	-L2	-L6			
JP75ZP	-L20					
JP75CP	-L20					
JP75SBC50	-L20					
JP75SBC87	-L20					
JP75SBC50R	-L20	-L2		-L		
JP75SBC87R	-L20					
JP75HBC25R	-L20					
JP75HBC50R	-L20	-L2		-L		
JP75HBC75R	-L20					
JP75UF100	-L20					
JP131W	-L20		-L6		-L5	-L3
JP131WP2	-L20					
JP131CM	-L20					
JP131DW	-L20		-L6			
JP131ZP	-L20					
JP131CP	-L20					
JP131SBC50	-L20					
JP131SBC87	-L20					
JP131SBC50R	-L20	-L2		-L		
JP131SBC87R	-L20					
JP131HBC25R	-L20					
JP131HBC50R	-L20	-L2		-L		
JP131HBC75R	-L20					
JP131UF100	-L20					
JP2W	-L20	-L2	-L6	-L	-L5	-L3
JP2WP2	-L20					
JP2CM	-L20	-L2				
JP2DW	-L20	-L2	-L6	-L		
JP2ZP	-L20					
JP2CP	-L20					
JP2SBC50	-L20			-L		
JP2SBC87	-L20					
JP2SBC50R	-L20	-L2		-L		
JP2SBC87R	-L20	-L2				
JP2HBC25R	-L20					
JP2HBC50R	-L20	-L2		-L		
JP2HBC75R	-L20					
JP2UF100	-L20					
JP4W	-X20	-X2	-X6	-X		
JP4WP2	-X20					
JP4CM	-X20					
JP4ZP	-X20					
JP4CP	-X20					
JP4SBC50	-X20			-X		
JP4SBC87	-X20					
JP4SBC50R	-X20	-X2		-X		
JP4SBC87R	-X20					
JP4HBC25R	-X20					
JP4HBC50R	-X20	-X2		-X		
JP4HBC75R	-X20					
JP4UF100	-X20					

UL LISTED PATENTED J-Mod® Cable Support System

- Complete horizontal and vertical 1" (25.4mm) bend radius control
- Manufactured from materials that meet UL 2043 and are suitable for use in air handling spaces
- Brackets allow for attachment to ceilings, beams, threaded rods, and drop wires to meet requirements of a variety of applications
- Cables do not come in contact with metal
- Modular design allows flexibility to assemble system in multiple configurations
- Unique chaining bracket design creates a strong metal backbone and allows expansion of the system without disturbance of an existing installation

Typical Installation Instructions Using Threaded Rod Bracket and Chaining Bracket



Align snap lock attachment of J Hook with holes in chosen bracket and snap J Hook into place



Align chaining bracket under the assembly



Slide chaining bracket between J Hook and the metal bracket until it snaps



Pull down to fully engage



Attach J Hooks as explained in first-level installation above



Final assembly is a second-level installation consisting of one threaded rod bracket, one chaining bracket, and two J Hooks for clarity



J-Mod® Cable Support System (continued)



JMjH2W-X20



JMjH2-X20



JMjCB-X



JMjCMB25-1-X



JMjCMB25-3-X



JMjDWB-1-X



JMjDWB-3-X



JMjTRB38-1-X



JMjTRB38-3-X



JMjSBCB87-1-X



JMjSBCB87-3-X

Part Number	Part Description	Material*	Std. Pkg. Qty.	Std. Ctn. Qty.
J Hook with Maximum 2" Bundle Capacity				
JMjH2W-X20	J Hook for wall mount applications only. Two 1/4" (M6) mounting holes for user supplied screws.	Nylon 6.6	10	50
JMjH2-X20	J Hook with snap lock attachments for use with all brackets listed below.	Nylon 6.6	10	50
Chaining Bracket				
JMjCB-X	Chaining bracket to extend J-Mod® capacity one level. Capacity: three levels maximum. For use with all single-level mounting brackets listed below.	Zinc Plated Steel	10	50
Ceiling Mount Brackets				
JMjCMB25-1-X	Single-level ceiling mount bracket with one 1/4" (M6) mounting hole.	Galvanized Steel	10	50
JMjCMB25-3-X**	Three-level ceiling mount bracket with one 1/4" (M6) mounting hole. Maximum capacity of six J Hooks.	Galvanized Steel	10	50
Drop Wire Brackets				
JMjDWB-1-X	Single-level drop wire bracket. Attaches to #12 wire or 3/8" (9.5mm) threaded rod. Maximum capacity of one J Hook per level.	Galvanized Steel with Metal Attachments	10	50
JMjDWB-3-X**	Three-level drop wire bracket. Attaches to #12 wire or 3/8" (9.5mm) threaded rod. Maximum capacity of one J Hook for each of three levels. Maximum static load of 40 pounds.	Galvanized Steel with Metal Attachments	10	50
Threaded Rod Brackets				
JMjTRB38-1-X	Single-level threaded rod bracket. Accepts 1/4" – 3/8" (6.4mm – 9.5mm) threaded rod.	Galvanized Steel with Metal Attachments	10	50
JMjTRB38-3-X**	Three-level threaded rod bracket. Accepts 1/4" – 3/8" (6.4mm – 9.5mm) threaded rod. Maximum capacity of six J Hooks.	Galvanized Steel with Metal Attachments	10	50
Screw-On Beam Clamp Brackets				
JMjSBCB87-1-X	Single-level screw-on beam clamp bracket for use with flanges up to 3/4" (19.1mm) thick.	Galvanized Steel with Metal Attachments	10	50
JMjSBCB87-3-X**	Three-level screw-on beam clamp bracket for use with flanges up to 3/4" (19.1mm) thick. Maximum capacity of six J Hooks.	Galvanized Steel with Metal Attachments	10	50

*Suitable for use in air handling spaces and listed in accordance with UL 2043 and CAN/ULC S102.2 when mounted as single units or in pairs. Maximum spacing of 4' (1220mm) required between mount points. (Flame Spread Rating = 0, Smoke Developed Classification = 30).

**Not for use with chaining brackets.

	Maximum Cable Capacity		
	Cat 6A (0.300")	Cat 6 (0.240")	Cat 5e (0.225")
JMjH2W or JMjH2	30	46	55

UL **PATENTED** **Conduit Waterfall**

- Helps prevent pinch points and over bending that could cause damage to cable
- Suitable for use in air handling spaces per UL 2043
- UL listed per UL 1565
- Able to manage and support a large capacity of cables
- Easy and fast to install reducing labor cost

- Unique patented design allows for use in both new and retrofit applications
- Allows user to install 3/4" (19.1mm) Tak-Ty® Cable Ties to provide a method to retain and manage the cable bundle
- Material: Black Glass-Filled Nylon 6.6 which meets UL 94V-0 specifications



Part Number	Part Description	Std. Pkg. Qty.	Std. Ctn. Qty.
CWF400	Provides bend radius control for cables entering/exiting 4" (101.6mm) EMT conduit. Secure to conduit without tools utilizing integral thumb screw and captive nut.	1	10

PATENTED **Waterfall Accessories**

- Patented bend radius control product for standard ladder rack
- Product available as a kit (includes base, two wings, and cable ties) or purchased separately
- Easy to install waterfall kit maintains bend radius control in both vertical and horizontal directions to provide a standards-compliant installation

- Base attaches to either the rung or stringer on most standard ladder racks for a variety of installations/configurations
- Modular components allow user to custom configure each location where cable management is required
- Material: Black Glass-Filled Nylon 6.6 which meets UL 94V-0 specifications



CMW-KIT

Part Number	Part Description	Std. Pkg. Qty.	Std. Ctn. Qty.
CMW-KIT*	Cable management waterfall kit. Provides bend radius control when transferring cables from standard ladder rack. Kit includes CMWB, two CMWW, and cable ties.	1	10
CMWB*	Cable management waterfall base. Used to maintain 1.75" (44.5mm) bend radius control vertically when transferring cable off of ladder rack. Mounts to ladder rack rung or stringer with standard cross section cable ties (included).	1	10
CMWW*	Cable management waterfall wing. Used in conjunction with CMWB to maintain 1.00" (25.4mm) bend radius control horizontally when transferring cable off ladder rack.	1	10

*Available in natural (white). Add 10 to part number suffix. For example: CMW-KIT10.



CMWB



CMWW

Double Waterfall Accessory

- Double waterfall base attaches to the rung on most standard ladder racks to allow bend radius control for cables coming from either direction
- Easy to install double waterfall base maintains bend radius control in a vertical direction to provide a standards-compliant installation
- Material: Black Glass-Filled Nylon 6.6 which meets UL 94V-0 specifications



Part Number	Part Description	Std. Pkg. Qty.	Std. Ctn. Qty.
CMW2B	Cable management double waterfall base. Used to maintain 1.75" (101.6mm) bend radius control vertically when transferring cable off either side of ladder rack rung. Mounts to ladder rack rung with standard cross section cable ties (included).	1	10

Threaded Rod Cover

- Protects cable from abrasion caused by contact with threaded rod
- Available in 18" (457mm) lengths
- Accepts 1/2" to 5/8" (12.7mm to 15.9mm) threaded rod
- For indoor use only
- Material: Flame Retardant Polyethylene which meets UL 94V-0 specifications



Part Number	Part Description	Std. Pkg. Qty.	Std. Ctn. Qty.
TRC18FR-X8Y	Used to protect cabling from threaded rod. Vertical slit allows easy installation. Gray.	10	100
TRC18FR-X20Y	Used to protect cabling from threaded rod. Vertical slit allows easy installation. Black.	10	100

PATENTED Stackable Cable Rack Spacers

- Patented accessories for standard ladder racks
- Separate and support cable and prevent pinch points between the bottom row of cable and the rung as a result of the weight of multiple cable layers applied on top of each other
- Mount to ladder rack with standard cross section cable ties
- Maximize rack space by stacking products for maximum cable capacity
- Provide an alternative to lacing cord by allowing user to secure cable to spacer to prevent movement of cable



CRS4-125-X



CRS1-125-X



CRS6-X



CRS1-X

Part Number	Part Description	Width		Std. Pkg. Qty.	Std. Ctn. Qty.
		In.	mm		
CRS4-125-X	Four space stackable cable rack spacer. Manufactured from black glass-filled flame retardant nylon 6.6. Accepts cable up to 1.25" (31.8mm) diameter.	5.24	133.1	10	100
CRS1-125-X	One space stackable cable rack spacer. Manufactured from black glass-filled flame retardant nylon 6.6. Use with CRS4 to fill width of ladder rack. Accepts cable up to 1.25" (31.8mm) diameter.	1.55	39.4	10	100
CRS6-X	Six space stackable cable rack spacer. Manufactured from black polycarbonate ABS blend. Accepts cable up to .80" (20.3mm) diameter.	5.25	133.4	10	100
CRS1-X	One space stackable cable rack spacer. Manufactured from black polycarbonate ABS blend. Use with CRS6 to fill width of ladder rack. Accepts cable up to .80" (20.3mm) diameter.	1.13	28.58	10	100

Part Number	Maximum Cable Capacity		
	Cat.6A (0.300")	Cat.6 (0.240")	Cat.5e (0.225")
CRS4-125-X	10	15	17
CRS1-125-X	10	15	17
CRS6-X	5	7	8
CRS1-X	5	7	8

GROUNDING AND BONDING

Panduit grounding and bonding solutions meet customer needs and today's critical application requirements for grounding data centers and telecommunication spaces. Panduit® StructuredGround™ Grounding System provides a high quality, visually verifiable, and dedicated grounding path to maintain system performance and protect network equipment and personnel. Panduit grounding and bonding components are designed for use on racks and cabinets which meet EIA-310.

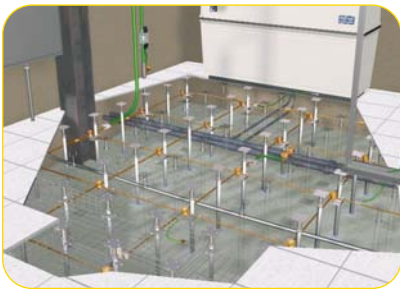
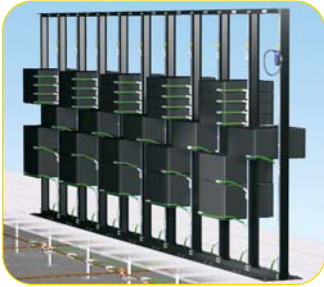

- Ensures highest network system performance
- Prevents equipment damage
- Maximizes uptime
- Meets TIA-942, TIA-607-B, IEEE Std 1100 (IEEE Emerald Book), UL and CSA
- Promotes personnel protection
- Designed for flexibility and easy installation

StructuredGround™ Grounding System components provide a low resistance grounding path for reliability; include factory terminated jumpers for easy installation; and are kitted for convenience. Jumper kits include Panduit Copper Compression Electrical Connectors that meet NEBS Level 3 Criteria, the highest level of operability within the network facility environment. A full line of manual, controlled cycle, and battery operated hydraulic crimping tools meet application needs and provide lowest installed cost. For the complete line of Panduit Electrical Power and Grounding Connectors and crimping tools, visit www.panduit.com or refer to the Electrical Solutions Catalog SA-ELCB10.

THE PURPOSE OF GROUNDING AND BONDING



The grounding and bonding system is more than just an insurance policy against a lightning strike or other surge event. It is an active, functioning system that provides protection for personnel and equipment. Proper grounding and bonding are essential for efficient network performance in the modern data center and telecommunication spaces.

A primary purpose of the grounding and bonding system is to create an adequate-capacity path for electrical surges and transient voltages to return to their source (which may include the earth). Lightning, fault currents, circuit switching (motors turning on and off), activation of surge protective devices (SPDs) and electrostatic discharge are common causes of these electrical surges and transient voltages. An effective grounding and bonding system minimizes the detrimental effects of these electrical surges and transient voltages.

A properly designed grounding and bonding system is intentional, visually verifiable, and adequately sized to handle expected currents safely and without undue effect on susceptible electronic equipment. Any metallic component that is part of the data center infrastructure (such as equipment, racks, ladder racks, cabinets, cable trays, etc.) must be properly connected to the grounding and bonding system.

WHAT ARE THE EFFECTS OF IMPROPER GROUNDING?

Lower Reliability

- An improperly designed grounding (and bonding) system may be a primary source of interference and emission⁽¹⁾
- According to the IEEE, the typical AC third-prong ground circuit is almost never sufficient to prevent damage to network equipment susceptible to ground-fault related potentials⁽²⁾
- Poorly designed or improperly applied grounding, bonding, and shielding techniques often adversely affect the performance of electronic equipment – from the circuit board to the network system⁽³⁾
- Approximately 70% of all anomalies, dysfunctions, or problems associated with power distribution systems are directly or indirectly related to bonding and grounding issues⁽⁴⁾

Safety Risks

- Personal injury from electric shock caused by improper grounding and bonding can cause immeasurable human suffering and significant expense
- Potential fire hazards exist when heat is generated from electrical surges that occur on a high impedance grounding and bonding path

1. Ott, Henry. *Noise Reduction Techniques in Electronic Systems.*, 2nd edition. NY: Wiley-Interscience, 1988.

2. Institute of Electrical and Electronics Engineers. IEEE Std 1100 – 2005. *IEEE Recommended Practice for Powering and Grounding Electronic Equipment.*

3. Quoted from Doug Dorr, Senior Project Manager, EPRI and William Bush, Industry Consultant for Power and Grounding and Surge Protection. Both serve on the IEEE P1100 committee (Emerald Book) in leadership positions and also on the IEEE SPD committee, as well as other standards organizations.

4. Quoted from S. Frank Waterer, Electrical Engineering, Fellow, at Schneider Electric with 30 years experience, Vice-Chair of IEEE/SPDC, NEMA member.

CAN YOU AFFORD IMPROPER GROUNDING?

According to IEEE, grounding and bonding are an essential part of the infrastructure, not just a tool to achieve power quality.⁽²⁾ Network equipment, such as switches, routers, and storage devices, costs anywhere from thousands of dollars to hundreds of thousands of dollars. The cost of proper grounding is only a tiny fraction of the cost of the equipment it is protecting. Clearly the cost of proper grounding and bonding is a small fraction of the larger cost of improper grounding and bonding – mainly, the inability to service customers properly.

Protect your infrastructure with the most comprehensive grounding system, designed specifically for easy selection and installation with the highest quality components to minimize your risk.

From the data center, to the manufacturing floor, to facilities operations, there are critical systems and equipment that require proper grounding and bonding. Protecting those systems, equipment, and personnel helps to ensure equipment reliability and thus availability of services, while resulting in lower operational expense.

Comprehensive, integrated technology from Panduit addresses the grounding and bonding needs of the entire infrastructure including electrostatic discharge (ESD) protection, racks, cabinets, enclosures, access floors, control panels, service entrance, and direct burial applications. These industry-leading solutions deliver reliability, availability, safety and lower total cost of ownership. As a solution architecture, the StructuredGround™ Grounding System is complemented by a range of installation tooling, design software, and services.

Panduit® StructuredGround™ Grounding System gives you what you need to properly protect your investment.

1. Ott, Henry, *Noise Reduction Techniques in Electronic Systems*, 2nd edition, NY; Wiley-Interscience, 1988.
2. Institute of Electrical and Electronics Engineers, IEEE Std 1100 – 2005, *IEEE Recommended Practice for Powering and Grounding Electronic Equipment*.
3. Quoted from Doug Dorr, Senior Project Manager, EPRI and William Bush, Industry Consultant for Power and Grounding and Surge Protection. Both serve on the IEEE P1100 committee (Emerald Book) in leadership positions and also on the IEEE SPD committee, as well as other standards organizations.
4. Quoted from S. Frank Waterer, Staff Engineer at Schneider Electric with 30 years experience.

Common Bonding Network (CBN) Roadmap

- Panduit® StructuredGround™ Grounding System is a complete, highly reliable line of products to ground your building and network equipment in compliance with BICSI TDM Manual, 12th Edition and TIA-607-B, TIA-942, IEEE Std 1100 (IEEE Emerald Book), UL and CSA



**Telecommunications
Room**
(see roadmap on
page M.6)

Data Center
(see roadmaps on
pages M.8 – M.9)







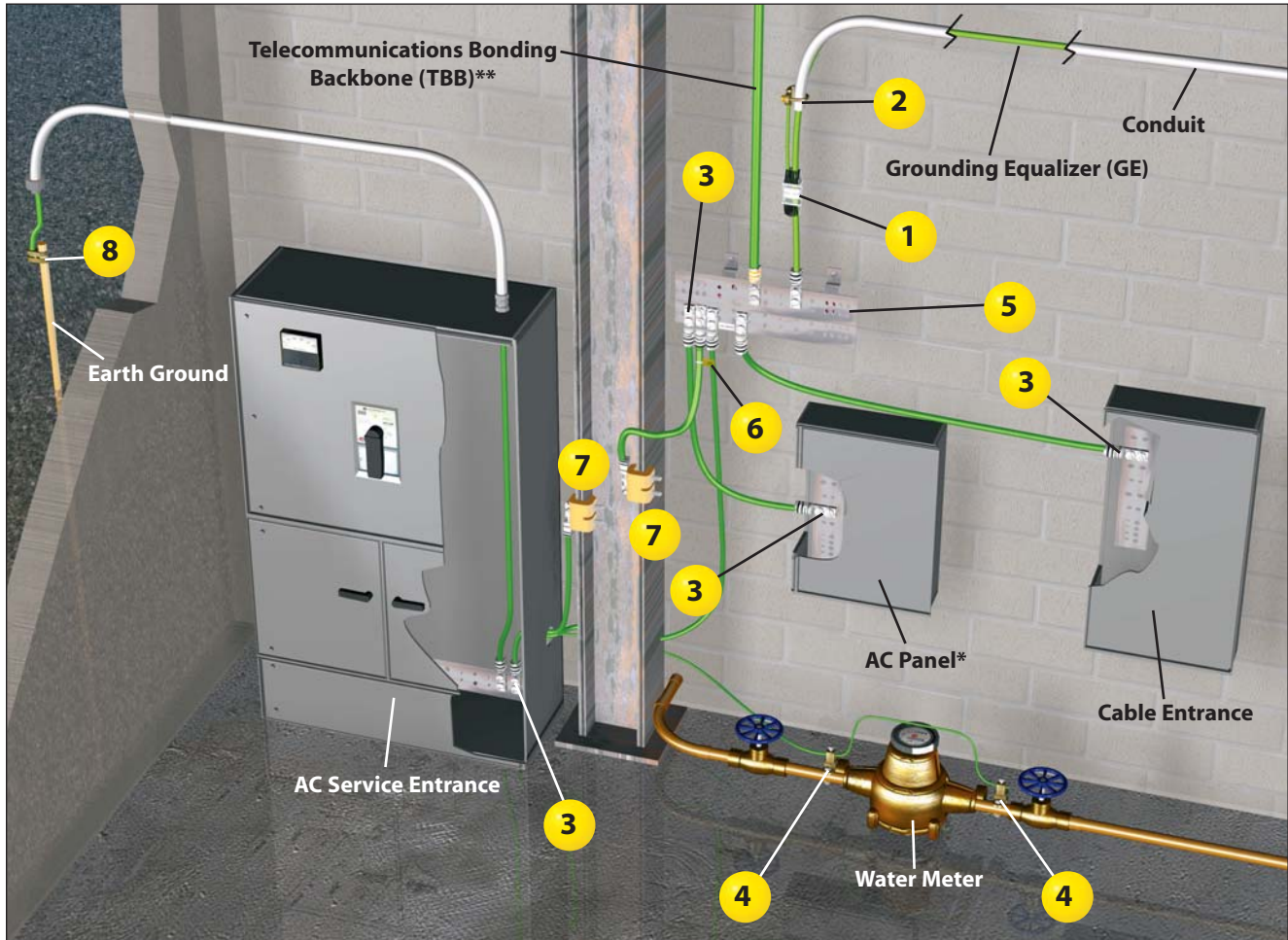

Service Entrance
(see roadmap on
page M.5)

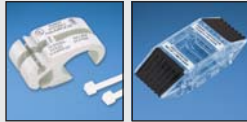
For more data center grounding information, see www.panduit.com/dcgrounding.

Service Entrance Grounding Roadmap

- Complies with TIA-607-B and IEEE Std 1100 (IEEE Emerald Book)
- Grounding Equalizer (GE) is required when two or more Telecommunications Bonding Backbones (TBB) are used within a multi-story building; bond TBBs together with a GE at the top floor and at a minimum of every third floor in between



<p>1 Copper Compression HTAP and Clear Cover: HTWC (pages M.41 thru M.42)</p> 	<p>5 Telecommunications Main Grounding Busbar (TMGB) and Busbar Label (page M.29)</p> 
<p>2 Bronze, U-Bolt Grounding Clamp: GPL (page M.44)</p> 	<p>6 Telecommunications Grounding and Bonding Conductor Label Kit: LTYK (page M.29)</p> 
<p>3 Copper Compression, Two-Hole, Long Barrel with Window Lug: LCC-W (pages M.36 – M.38)</p> 	<p>7 Universal Beam Grounding Clamp: GUBC500-6 (page M.31)</p> 
<p>4 Bronze, Water Pipe Grounding Clamp: KP (page M.44)</p> 	<p>8 E Style Grounding Connector: GCE For the complete line of StructuredGround™ Direct Burial Compression Grounding System, visit www.panduit.com</p> 

*AC panel should be grounded per NEC standards. Enclosure should be grounded per manufacturer's specifications.
 **TIA-607-B specifies different size conductors based on the length of the Telecommunications Bonding Backbone (TBB).

Telecommunications Room Grounding Roadmap

- Complies with BICSI TDM Manual, 12th Edition and TIA-607-B, TIA-942, IEEE Std 1100 (IEEE Emerald Book), UL and CSA
- Bonding hardware is recommended to mount all panels, equipment, shelves, etc. to ensure electrical continuity between metallic components and the grounded rack or cabinet
- Can be used to ground equipment mounted in racks and cabinets which meet EIA-310; installer should bond all racks and cabinet members to the grounding strip

Back of Racks Shown

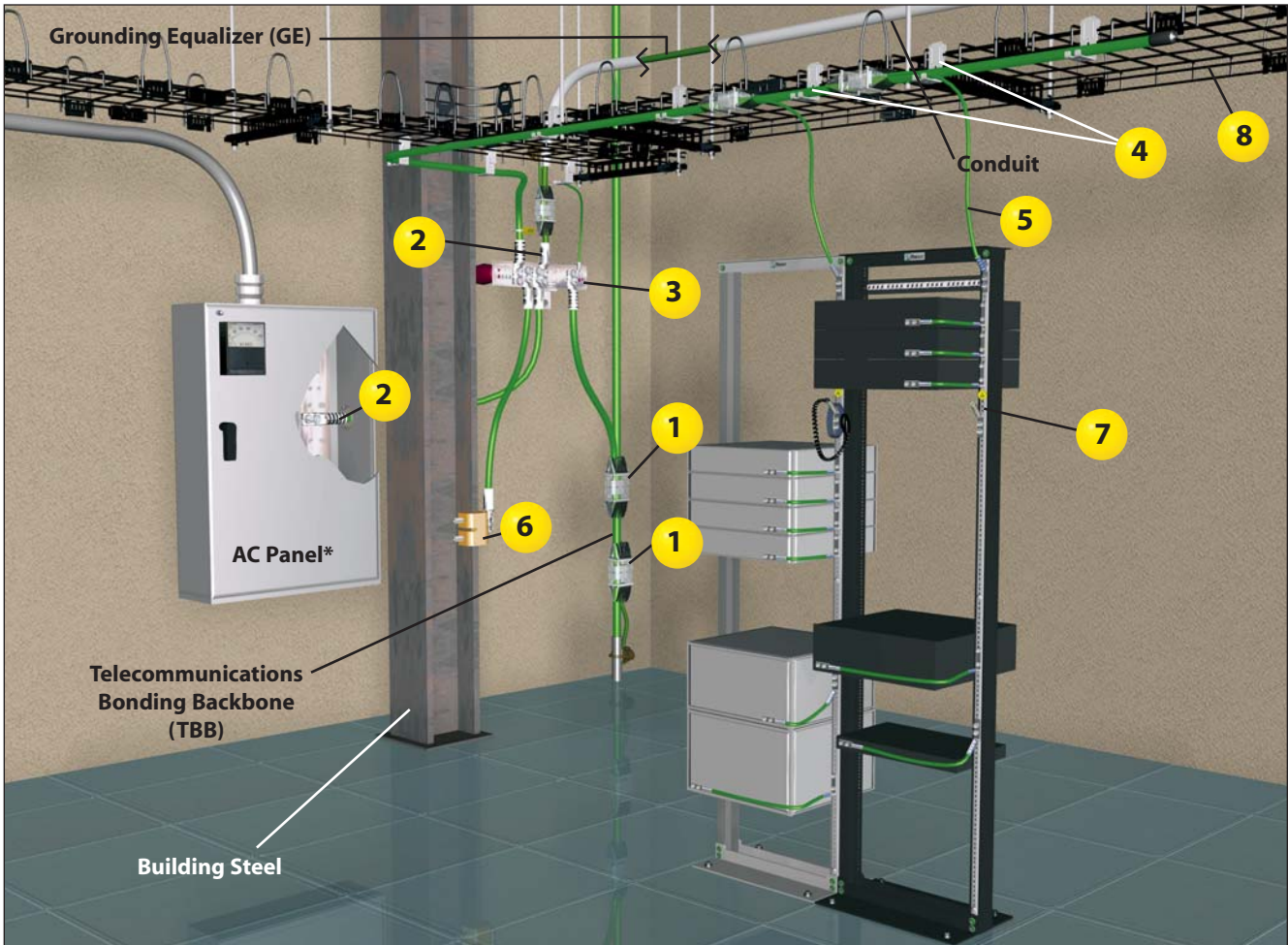

1 Copper Compression HTAP and Clear Cover: HTWC (pages M.41 – M.42)



2 Copper Compression, Two-Hole, Long Barrel with Window Lug: LCC-W (pages M.36 – M.38)



3 Telecommunications Grounding Busbar (TGB) and Busbar Label (page M.29)



4 Auxiliary Cable Bracket: GACB (page M.31)



5 Telecommunication Equipment Bonding Conductor (TEBC) Kits: (pages M.21 – M.22)



6 Universal Beam Grounding Clamp: GUBC500-6 (page M.31)



7 Electrostatic Discharge (ESD) Port Kit: RGESD (page M.24)



8 Wyr-Grid® Overhead Cable Tray Routing System (page J.65 – J.74)



*AC panel should be grounded per NEC standards. Enclosure should be grounded per manufacturer's specifications.

A typical overhead cabling system includes a multitude of metallic components which are connected together. It is the responsibility of the installer to insure all of the metallic components are bonded, which means that they are connected together electrically in accordance with applicable specifications. The Panduit Grounding and Bonding System does not insure required bonding of the overhead cabling system metallic components.

Access Floor Mesh Common Bonding Network (MCBN) Roadmap

- Complies with BICSI TDM Manual, 12th Edition and TIA-607-B, TIA-942, IEEE Std 1100 (IEEE Emerald Book), UL and CSA
- MCBN for access floor deployment is recommended in a grid design on 4 foot intervals, allowing for bonding of every other access floor pedestal; this design enables the bonding of at least one pedestal from each access floor tile directly to the MCBN network
- Bond all metallic elements to the MCBN, including rack/cabinet grounding jumpers, wire basket, water pipes and air conditioning units

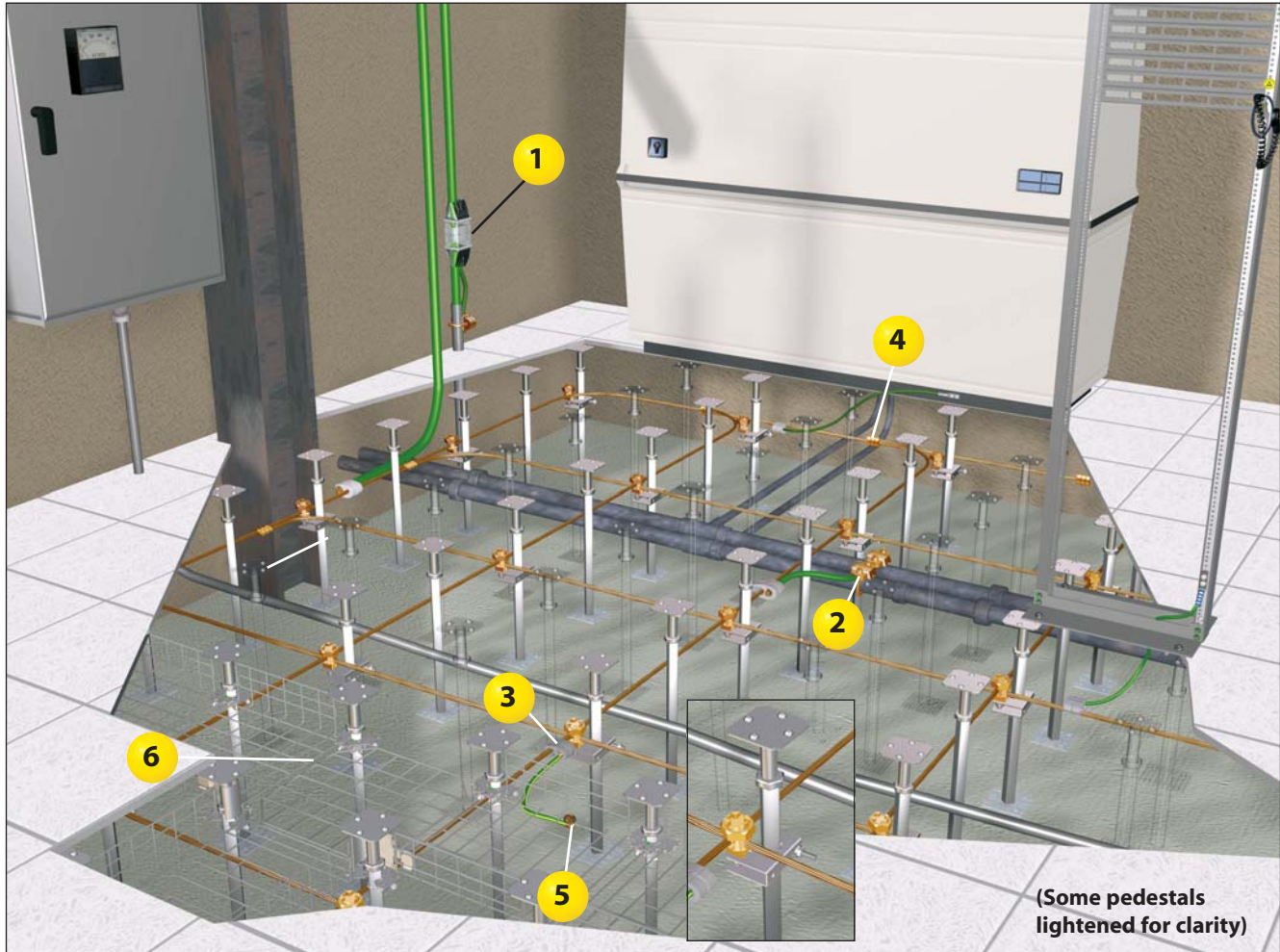

1 Copper Compression HTAP and Clear Cover: HTWC (pages M.41 – M.42)



4 Code Conductor, Thin Wall, CTAP: CTAPF (page M.43)



2 Bronze, U-Bolt Grounding Clamp: GPL (page M.44)



5 Split Bolt, Copper: SBC (page M.45)



3 Access Floor Grounding Clamp: GPQC (page M.16)

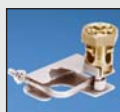

6 GridRunner™ Underfloor Cable Routing System (pages J.75 – J.79)





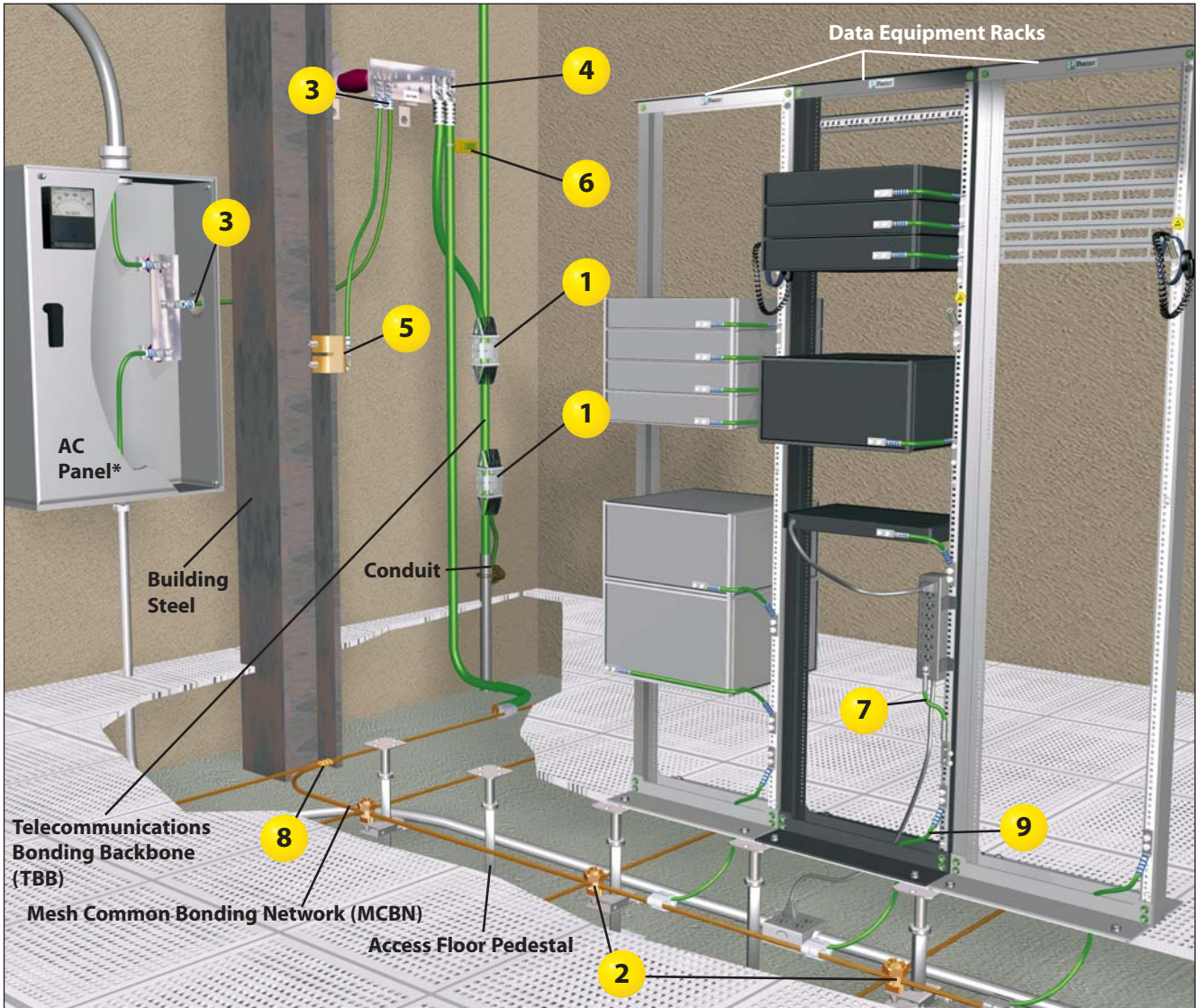

Data Center Rack and Cabinet Grounding Roadmap

- Complies with BICSI TDM Manual, 12th Edition and TIA-607-B, TIA-942, IEEE Std 1100 (IEEE Emerald Book), UL, and CSA
- Bonding hardware is recommended to mount all panels, equipment, shelves, etc. to ensure electrical continuity between metallic components and the grounded rack or cabinet
- Designed for use on racks and cabinets which meet EIA-310, see pages L.1 – L.74 for the Panduit cabinets, racks, and cable management offering

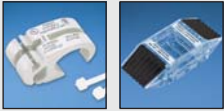
Back of Racks Shown



<p>1 Copper Compression HTAP and Clear Cover: HTWC (pages M.41 – M.42)</p> 	<p>3 Copper Compression, Two-Hole, Long Barrel with Window Lug: LCC-W (pages M.36 – M.38)</p> 
<p>2 Access Floor Grounding Clamp: GPQC (page M.16)</p> 	<p>4 Telecommunications Grounding Busbar (TGB) and Busbar Label (page M.29)</p> 
	<p>5 Universal Beam Grounding Clamp: GUBC500-6 (page M.31)</p> 

*AC panel should be grounded per NEC standards. Enclosure should be grounded per manufacturer's specifications.
 A typical access floor includes a multitude of metallic components which are connected together. It is the responsibility of the manufacturer and installer of the access floor to insure all the access floor metallic components are bonded which means that they are connected together electrically in accordance with applicable specifications. The Panduit Grounding and Bonding System does not insure required bonding of the access floor metallic components.

Back of Cabinets Shown



6

**Telecommunications
Grounding and Bonding
Conductor Label Kit: LTYK**
(page M.29)



8

**Code Conductor, Thin Wall,
CTAP: CTAPF**
(page M.43)



7

**Surge Suppressor Jumper
Kit: SSGK**
(page M.20)



9

**Common Bonding
Network (CBN)
Jumper Kit: RGCBNJ**
(page M.16)



A typical access floor includes a multitude of metallic components which are connected together. It is the responsibility of the manufacturer and installer of the access floor to insure all the access floor metallic components are bonded which means that they are connected together electrically in accordance with applicable specifications. The Panduit Grounding and Bonding System does not insure required bonding of the access floor metallic components.



Selection Guide – StructuredGround™ Kits for Net-Access™ Cabinets

- Complies with the “Telecommunications Infrastructure Standard for Data Centers” as described in TIA-942 and TIA-607-B
- Maximizes uptime, maintains system performance, and protects network equipment
- Provides a dedicated, low resistance, and visually verifiable ground system
- Flexible design for use on EIA-310 compliant cabinets

*Typical cage nut application
Back of cabinet shown
(Sides/doors removed for clarity)
Kits for threaded and thru-hole also available*

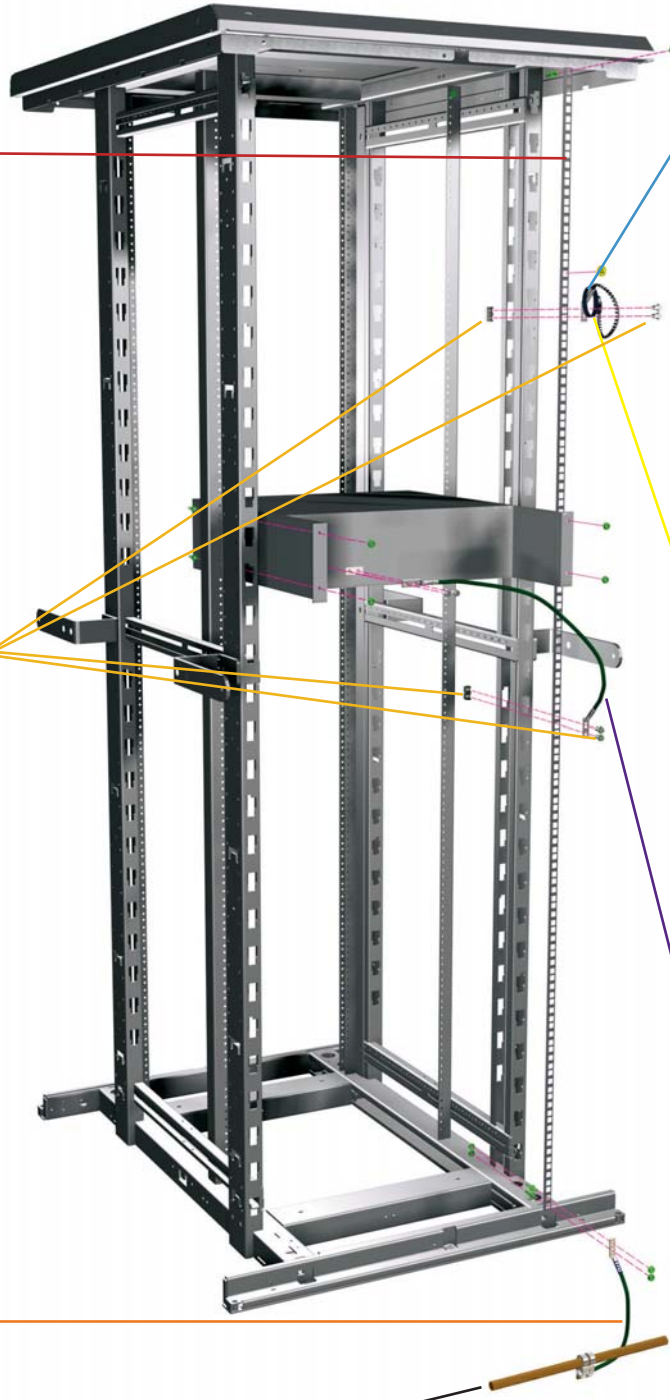

Grounding Strip Kit: RGS (page M.17)
Patented hardware provides a bond between grounding strip and cabinet, eliminating the need to scrape paint

Bonding Cage Nut: CNBK (page M.25)
Patented, bonds equipment and patch panels to cabinet rails

Common Bonding Network (CBN) Jumper Kit: RGCBNJ (page M.16)
Connects grounding busbar to MCBN in access floor and overhead grounding applications

Electrostatic Discharge (ESD) Port Kit: RGESD (page M.24)
Bent 45° acts as a hook to hold ESD wrist strap

Electrostatic Discharge (ESD) Wrist Strap Kits: RGESDWS (page M.24)
Prevents damaging electrostatic discharge to equipment and personnel

Equipment Jumper Kit: RGEJ (page M.19)
Bonds network equipment to the grounding strip or grounding busbar

Mesh Common Bonding Network (MCBN)

Selection Guide – StructuredGround™ Kits for Net-Access™ Cabinets (continued)

Cabinet Grounding Selection in 2 Easy Steps:

1. What type of fasteners do your mounting rails require?
2. What is the maximum depth of the equipment being mounted?

Selection Criteria		Grounding Strip Kit [▲]	ESD Port Kit (2 required) [‡]	ESD Wrist Strap (1 per ESD Port)	Grounding Busbar Kit [▲]	Front to Back Rail Jumper Kit [▲]	Common Bonding Network (CBN) Jumper Kit [*]	Equipment Jumper Kit ^{**}	Bonding Hardware ^{***}
Panduit® Net-Access™ Cabinets: CN1, CN2, CN4, CN5, CN1CN, CN2CN, CS1, CS2 and CS3		StructuredGround™ Kits for Data Center Cabinet Grounding							
1. Rail Fasteners									
Threaded #12-24 [•]	RGS134-1Y	RGESD2-1	RGESDWS	—	—	RGCBNJ660P22	GJS660U	RGTBSC-C (Bonding Screw)	
Cage Nut ^{••}	RGS134B-1	RGESD2B-1	RGESDWS	—	—	RGCBNJ660P22	GJS660U	CNBK (Bonding Cage Nut)	
EIA-310 Compliant Cabinets		StructuredGround™ Kits for Data Center Cabinet Grounding							
1. Rail Fasteners	2. Rail Depth up to								
Threaded #12-24 or M6	20" (.5M)	RGS134-1Y	RGESD2-1	RGESDWS	RGRB19U	CGJ620U	RGCBNJ660P22	GJS660U	RGTBSC-C or RGTBSM6G-C
	30" (.75M)				CGJ630U				
	40" (1M)				CGJ640U				
Cage Nut	20" (.5M)	RGS134B-1	RGESD2B-1	RGESDWS	RGRB19CN	CGJ620UB	RGCBNJ660P22	GJS660U	CNBK (Bonding Cage Nut)
	30" (.75M)				CGJ630UB				
	40" (1M)				CGJ640UB				

[▲]Grounding strip kits, grounding busbar kits, and front to back rail jumper kits are supplied with mounting hardware based upon rail type.

[■]Grounding strip kits also available in packages of ten.

[‡]ESD port recommended for use on front and back of cabinet.

^{*}CBN jumper kit supports MCBN connection up to #2 AWG (35mm²). Use RGCBNJ660PY for cable sizes up to 250kcmil (120mm²).

^{**}Additional equipment jumper kits available in different sizes with different termination options, refer to page M.19. One equipment jumper kit is required per component.

^{***}Use bonding hardware to mount and bond equipment to the cabinet.

[•]Threaded #12-24 rails are included with the CN1, CN2, CN4 and CN5 cabinets.

^{••}Cage nut equipment rails are sold in pairs for the cabinets, order part number CNRC, CN1CN, CN2CN, CS1, CS2 or CS3.



Selection Guide – StructuredGround™ Kits for Racks

- Complies with the “Telecommunications Infrastructure Standard for Data Centers” as described in TIA-942 and TIA-607-B
- Maximizes uptime, maintains system performance, and protects network equipment
- Provides a dedicated, low resistance, and visually verifiable ground system
- Flexible design for use on EIA-310 compliant racks

*New installation
Typical threaded application
Back of rack shown
Kits for cage nut and thru-hole also available*

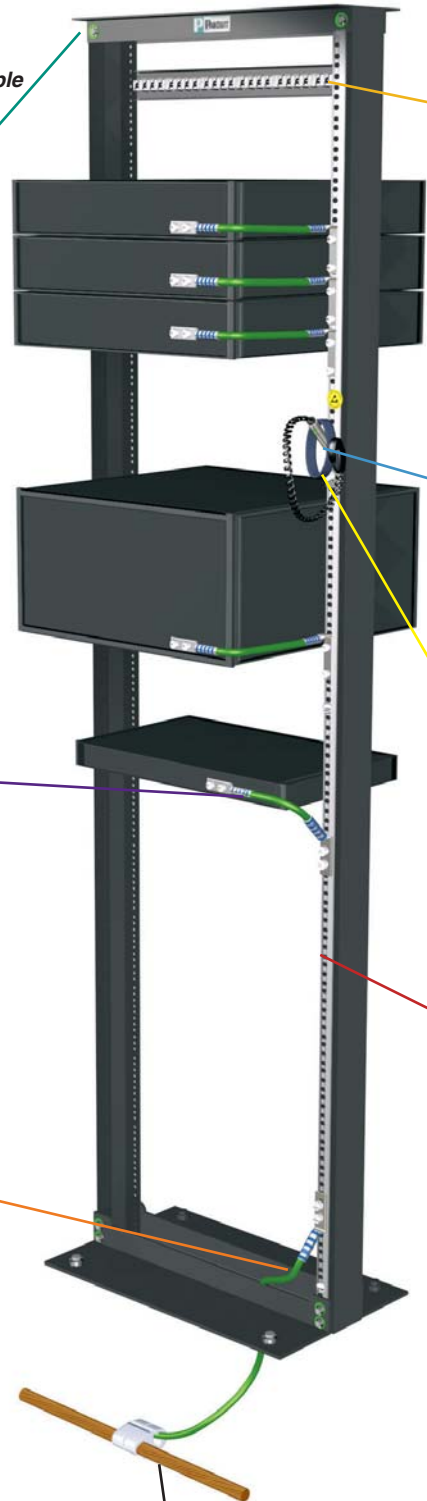

Paint Piercing Grounding Washer Kit: RGW (page M.26)
Provides a superior bond between frame members, serrations eliminate the need to scrape paint

Equipment Jumper Kit: RGEJ (page M.19)
Bonds network equipment to the grounding strip or grounding busbar

Common Bonding Network (CBN) Jumper Kit: RGCBNJ (page M.16)
Connects grounding strip or grounding busbar to MCBN in access floor and overhead grounding applications

Bonding Screw: RGTSB (page M.25)
Patented, bonds equipment and patch panels to the front of the rack.

Electrostatic Discharge (ESD) Port Kit: RGESD (page M.24)
Bent 45° acts as a hook to hold ESD wrist strap

Electrostatic Discharge (ESD) Wrist Strap Kit: RGESDWS (page M.24)
Prevents damaging electrostatic discharge to equipment and personnel

Grounding Strip Kit: RGS (page M.17)
Thread-forming hardware provides a bond between grounding strip and rack, eliminating the need to scrape paint

Mesh Common Bonding Network (MCBN)

Selection Guide – StructuredGround™ Kits for Racks (continued)

For Panduit racks:

Simply find your rack part number and follow across.

For other EIA-310 compliant racks, follow these two easy steps:

1. What type of installation do you have?
2. What type of fasteners do your mounting rails require?

Selection Criteria	Grounding Strip Kit	ESD Port Kit (2 required)*	ESD Wrist Strap (1 per ESD Port)	Grounding Busbar Kit	Common Bonding Network (CBN) Jumper Kit	Equipment Jumper Kit**	Bonding Hardware***
Panduit Racks	StructuredGround™ Kits for Data Center Rack Grounding						
2 Post Racks							
R2P, R2P48, R2PS New Installation	RGS134-1Y	RGESD2-1	RGESDWS	—	RGCBNJ660P22	GJS660U	RGTBSG-C (#12-24)
R2P, R2P48, R2PS Retrofit Installation	—			RGRB19U			
NFR84 New Installation		(1 each) RGESD-1Y and RGESD2-1		RGRB19U	RGCBNJ660P22	GJS660U	
NFR84 Retrofit Installation		RGRKCBNJY					
4 Post Racks							
R4P, R4P96 New Installation	RGS134-1Y	RGESD2-1	RGESDWS	—	RGCBNJ660P22	GJS660U	RGTBSG-C
R4P, R4P96 Retrofit Installation	—			RGRB19U		GJS660U	
R4PCN, R4P96CN New Installation	RGS134B-1	RGESD2B-1	RGESDWS	—	RGCBNJ660P22	GJS660U	CNBK
R4PCN, R4P96CN Retrofit Installation	—			RGRB19CN		GJS660U	
EIA-310 Compliant Racks	RGS134-1Y	RGESD2-1	RGESDWS	—	RGCBNJ660P22	GJS660U	RGTBSG-C (#12-24) or RGTBSM6G-C (M6)
		RGESD2A-1		—			RGTBS1032G-C (#10-32) or RGTBSM5G-C (M5)
	—	RGESD2-1		RGRB19U	RGCBNJ660P22	GJS660U	RGTBSG-C (#12-24) or RGTBSM6G-C (M6)
				RGRKCBNJY			

The paint piercing grounding washers work with 3/8" (M8) hardware, for all other sizes, use the grounding solution for retrofit installations.

*ESD port recommended for use on front and back of rack.

**Additional equipment jumper kits available in different sizes with different termination options, refer to page M.19. One equipment jumper kit is required per component.

***Use bonding hardware to mount and bond equipment to the rack.



Features and Benefits – StructuredGround™ Kits for Cabinets

Panduit offers a variety of kits with premium components engineered specifically to meet TIA-942 and TIA-607-B for reliable cabinet grounding.

- Provides a dedicated, low resistance, and visually verifiable ground system to maximize uptime, maintain data center system performance, and protect network equipment and personnel
- Offers ease of installation – no paint scraping required to bond cabinets; factory terminated jumpers simply bolt in place
- Incorporates a flexible design that can be used with cabinets which meet EIA-310

Grounding Strip Kit (see page M.17)

	A	Bonding Cage Nut is a patented hardware with paint piercing serrations designed to create a bond point between the cabinet rail and the equipment being installed
	B	Grounding Strip is made from high conductivity wrought copper and tin-plated to inhibit corrosion, providing the lowest resistance path to ground
	C	Reverse Bent Lugs are factory terminated on front to back rail jumper kits to bond the front and back cabinet rails; innovative design maximizes space by utilizing only one RU
	D	Bonding Studs include patented paint piercing serrations to create a bond point between the cabinet rail, strip, busbar and lug; equipment can be installed at any time without removal of stud
	E	Grounding Busbar is made from high conductivity, low resistance wrought copper and tin-plated to inhibit corrosion
	F	Electrostatic Discharge (ESD) Port is made from high conductivity, low resistance copper and tin-plated to inhibit corrosion plus it functions as an ESD wrist strap hanger
	G	Copper Compression HTAP is UL Listed and CSA Certified; used to make a highly reliable, permanent bond between the mesh common bonding network and common bonding network (CBN) jumper kit
	H	Jumper has UL, VW-1 flame rated green-and-yellow insulation and is factory terminated with copper compression, two-hole, long barrel with window lug; lug is UL Listed, CSA Certified and meets NEBS Level 3

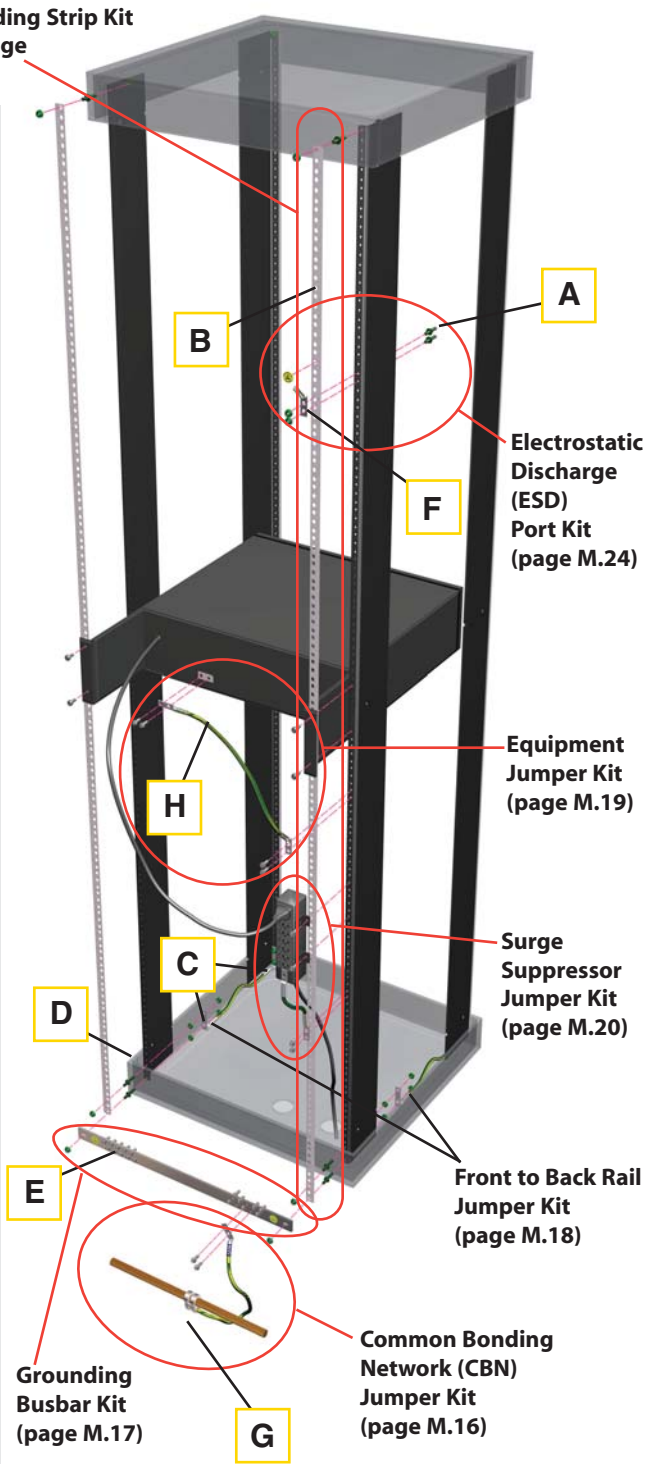



Features and Benefits – StructuredGround™ Kits for Racks

Panduit offers a variety of kits with premium components engineered specifically to meet TIA-942 and TIA-607-B for reliable rack grounding.

- Provides a dedicated, low resistance, and visually verifiable ground system to maximize uptime, maintain data center system performance, and protect network equipment and personnel
- Incorporates a flexible design that can be used with racks which meet EIA-310
- Offers ease of installation – no paint scraping required to bond racks; factory terminated jumpers simply bolt in place

	<p>A Paint Piercing Grounding Washer is made from hardened steel and electro zinc plated which inhibits corrosion to provide a superior bond between frame members on bolt-together racks</p>
	<p>B Grounding Strip is made from high conductivity wrought copper and tin-plated to inhibit corrosion, providing the lowest resistance path to ground</p>
	<p>C Thread-Forming Screws are made from electro zinc plated steel and provide a bond to the rack by removing paint from threaded holes without creating metal shavings</p>
	<p>D Electrostatic Discharge (ESD) Port is made from high conductivity, low resistance copper and tin-plated to inhibit corrosion plus it functions as an ESD wrist strap hanger</p>
	<p>E Electrostatic Discharge (ESD) Protection Sticker is provided in black and yellow for high visibility and easy identification as an ESD port</p>
	<p>F Copper Compression HTAP is UL Listed and CSA Certified; used to make a highly reliable permanent bond between the mesh common bonding network and common bonding network (CBN) jumper kit</p>
	<p>G Jumper has UL, VW-1 flame rated green-and-yellow insulation and is factory terminated with copper compression, two-hole, long barrel with window lug; lug is UL Listed, CSA Certified and meets NEBS Level 3 with a single stud hole and slot which allows mounting for 1/2" to 5/8" hole spacing and accommodates stud sizes 1/4", #12, and 6mm</p>

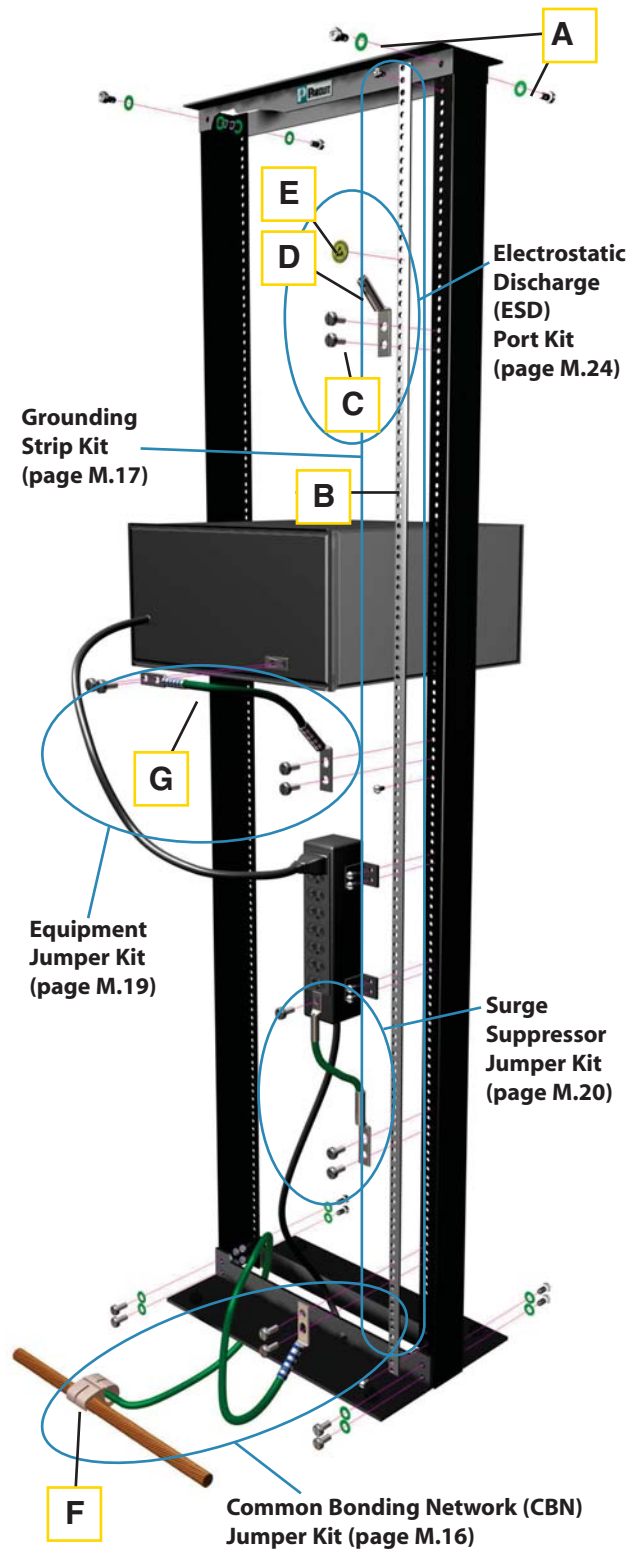

A.	System Overview
B.	Copper Systems
C.	Fiber Optic Systems
D.	Power over Ethernet
E.	Zone Cabling
F.	Wireless
G.	Outlets
H.	Media Distribution
I.	Physical Infrastructure Management
J.	Overhead & Underfloor Routing
K.	Surface Raceway
L.	Cabinets, Racks & Cable Management
M.	Grounding & Bonding
N.	Industrial
O.	Labeling & Identification
P.	Cable Management Accessories
Q.	Index



PATENTED

Access Floor Grounding Clamps

- Bond mesh common bonding network (MCBN) conductors to each other and bond the access floor pedestals to the conductors
- Specifically designed to bond perpendicular MCBN conductors per TIA-942 and TIA-607-B

- Bond to the pedestal with a single bolt to simplify installation
- Accommodate conductors from #6 – 1/0 AWG, minimizes inventory requirements
- Bond round and square access floor pedestals for greater flexibility



Installed on Pedestal

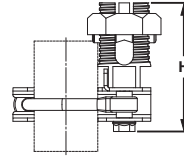
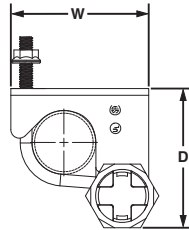

Part Number	Round Pedestal In.	Square Pedestal In.	MCBN Conductor Size Range AWG	Figure Dimensions In.			Tightening Torque In. – Lbs.		Std. Pkg. Qty.	Std. Ctn. Qty.
				D	W	H	Conductor	Clamp		
GPQC07-1/0	3/4 – 7/8	—	#6 SOL – 1/0 STR	4.25	3.38	3.19	385	150	1	10
GPQC10-1/0	1 – 1 1/8	7/8	#6 SOL – 1/0 STR	4.19	3.38	3.19	385	150	1	10
GPQC12-1/0	1 1/4	—	#6 SOL – 1/0 STR	4.53	3.44	3.19	385	150	1	10
GPQC15-1/0	1 1/2	—	#6 SOL – 1/0 STR	4.47	3.44	3.19	385	150	1	10
GPQC17-1/0	1 3/4	—	#6 SOL – 1/0 STR	5.19	4.00	3.19	385	150	1	10
GPQC20-1/0	2	—	#6 SOL – 1/0 STR	5.06	4.00	3.19	385	150	1	10



DB
RATED

Split Bolt Quad Clamp, Bronze



- Split bolt design allows easy insertion of perpendicular conductors speeding installation
- UL 467 Listed and CSA Certified for direct burial in earth or concrete
- UL Listed and CSA Certified for use up to 600 V and temperature rated 90°C

- Each clamp accepts up to two conductors for a high performance bond with faster installation
- Wide wire range-taking capability minimizes inventory requirements
- Made from high strength, electrolytic bronze to provide reliable grounding connections

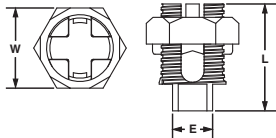

Part Number	Conductor Size Range	Figure Dimensions In.			Tightening Torque In. – Lbs.	Std. Pkg. Qty.
		E	W	L		
SBQC1/0-X	#6-1/0 AWG	0.75	1.50	2.00	#6 – #4 AWG – 165 #3 – #1 AWG – 275 1/0 AWG – 385	10



Common Bonding Network (CBN) Jumper Kits

- Bond the rack or cabinet to the MCBN
- HTAPs, included in kits, require crimping tool and die; see the CT-930 crimping tool on page M.47, the CT-2930/L and CT-2930/LE crimping tools on page M.48 and the CD-930H-250 and CD-920H-2 crimping dies on page M.49

- HTAPs are UL Listed and CSA Certified for applications up to 600 V when crimped with Panduit and specified competitor crimping tools and Panduit crimping dies
- Engineered to comply with US and International grounding requirements

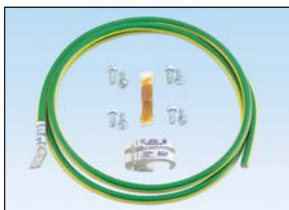

Part Number	MCBN Conductor Size AWG	Part Description	Std. Pkg. Qty.	Std. Ctn. Qty.
RGCBNJ660P22	HTCT2-2-1 #6 – #2 AWG	#6 AWG (16mm ²) jumper; 60" (1.52m) length; 45° bent lug on grounding strip side; provided with .16 oz. (5cc) of antioxidant, two each #12-24 x 1/2", M6 x 12mm, #10-32 x 1/2" and M5 x 12mm thread-forming screws and a copper compression HTAP* for connecting to the MCBN.	1	10
RGCBNJ660PY	HTCT250-2-1 #2 AWG – 250 kcmil		1	10

*HTAPs also sold separately, see pages M.41–M.42.



Grounding Strip Kits

- Bonds up to 45 RU per rack
- EIA Universal mounting hole pattern
- Engineered to comply with US and International grounding requirements



Threaded Rail Kit

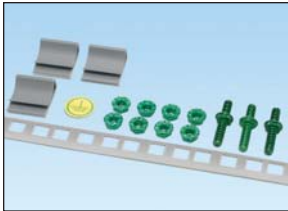

Cage Nut Rail Kit

Part Number	Part Description	Std. Pkg. Qty.
Grounding Strip Kits for Threaded Rail Fasteners		
RGS134-1Y	Grounding strip; 78.65" (2m) length; .67" (17mm) width; .05" (1.27mm) thickness; provided with .16 oz. (5cc) of antioxidant, one grounding sticker and three each #12-24 x 1/2" and M6 x 12mm thread-forming screws.	1
RGS134-10-1Y	Ten grounding strips; 78.65" (2m) length; .67" (17mm) width; .05" (1.27mm) thickness; provided with .16 oz. (5cc) of antioxidant, ten grounding stickers and 30 each #12-24 x 1/2" and M6 x 12mm thread-forming screws.	1
Grounding Strip Kits for Cage Nut Rail Fasteners		
RGS134B-1	Grounding strip; 78.70" (2m) length; .67" (17mm) width; .05" (1.27mm) thickness; provided with .16 oz. (5cc) of antioxidant, one grounding sticker, three cage nut bonding studs, eight #12-24 bonding nuts and three strip clips.	1
RGS134B-10-1	Ten grounding strips; 78.70" (2m) length; .67" (17mm) width; .05" (1.27mm) thickness; provided with .16 oz. (5cc) of antioxidant, ten grounding stickers, 30 cage nut bonding studs, 80 #12-24 bonding nuts and 30 strip clips.	1



Grounding Busbar Kits

- Provide the common grounding point within the cabinet
- Optimized for installation on 19" racks or cabinets that meet EIA-310
- Can be positioned anywhere on the rack or cabinet
- Available pre-assembled with twenty mounting screws for quick and easy installation
- Engineered to comply with US and International grounding requirements



RGRB19U

Part Number	Part Description	Std. Pkg. Qty.
Grounding Busbar Kits for Threaded Rail Fasteners		
RGRB19Y	Grounding busbar; 19" (483mm) length; tin-plated; fourteen holes arranged for flexibility in mounting; provided with two each #12-24 x 1/2" and M6 x 12mm thread-forming screws.	1
RGRB19U	Grounding busbar; 19" (483mm) length; tin-plated; twenty holes arranged for flexibility in mounting with twenty #12-24 x 1/2" hex head screws installed; mounting hole sets have 5/8" (15.9mm) spacing; provided with two each #12-24 x 1/2", M6 x 12mm thread-forming screws, and two #12 flat washers for mounting.	1
Grounding Busbar Kit for Cage Nut Rail Fasteners		
RGRB19CN	Grounding busbar; 19" (483mm) length; tin-plated; twenty holes arranged for flexibility in mounting with twenty #12-24 x 1/2" hex head screws installed; mounting hole sets have 5/8" (15.9mm) spacing; provided with two cage nut bonding studs and four #12-24 bonding nuts.	1

**Front to Back Rail Jumper Kits**

- Bond the front and back cabinet rails to the cabinet grounding busbar
- Patent pending hardware incorporates paint piercing serrations to create a bond point between the cabinet rail and lug; hardware never needs to be removed for new equipment installations

- Both ends are factory terminated with reverse bent lugs that save space, confining the connection to one RU
- Available in three lengths, 20", 30", and 40" to satisfy a wide range of cabinet rail depths
- Engineered to comply with US and International grounding requirements

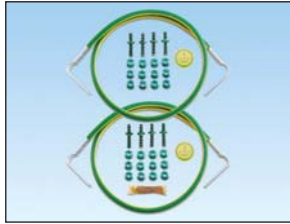

Part Number	Length In. (m)	Part Description	Std. Pkg. Qty.
-------------	----------------------	------------------	----------------------

Front to Back Rail Jumper Kits for #12-24 or M6 Rail Fasteners

CGJ620U	20 (.50)	Two #6 AWG (16mm ²) jumpers; factory terminated on both ends with 90° reverse bent lugs; provided with .16 oz. (5cc) of antioxidant, two grounding stickers, eight each #12-24 and M6 bonding studs and sixteen each #12-24 and M6 bonding nuts.	1
CGJ630U	30 (.75)		1
CGJ640U	40 (1.00)		1

Front to Back Rail Jumper Kits for Cage Nut Rail Fasteners

CGJ620UB	20 (.50)	Two #6 AWG (16mm ²) jumpers; factory terminated on both ends with 90° reverse bent lugs; provided with .16 oz. (5cc) of antioxidant, two grounding stickers, eight cage nut bonding studs and 24 #12-24 bonding nuts.	1
CGJ630UB	30 (.75)		1
CGJ640UB	40 (1.00)		1



Equipment Jumper Kits

- Bond network equipment to grounding strip or grounding busbar
- Jumper kit available with both ends factory terminated to provide a bolt-on solution
- Jumper kit available with one end factory terminated to attach to the grounding strip or grounding busbar; free end accommodates unique equipment terminations

- Use jumpers with 90° bent lug, on grounding strip side, for high density grounding requirements up to one ground point per RU
- Use jumpers with 45° bent lugs, on grounding strip side, for improved cable management
- Engineered to comply with US and International grounding requirements

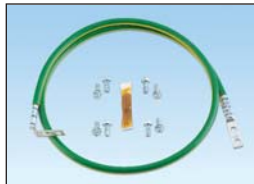

RGEJ1024PFY

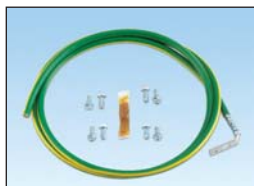

RGEJ1057PFY

Part Number	Length In. (m)	Angle	Part Description	Std. Pkg. Qty.	Std. Ctn. Qty.
-------------	----------------	-------	------------------	----------------	----------------

#6 AWG (16mm²) Equipment Jumper Factory Terminated on One End for Switches, Cabinets, and 4-Post Racks

GJS660U	60 (1.52)	Straight	#6 AWG green wire with yellow horizontal stripe. Jumper is pre-terminated on one end with LCC6-14JAW-L.	1	10
GJS696U	96 (2.44)	Straight		1	10

#10 AWG (6mm²) Equipment Jumpers Factory Terminated on Both Ends

RGEJ1024PHY	24 (0.61)	45°	#10 AWG (6mm ²) jumper; bent lug on grounding strip side to straight lug on equipment; provided with .16 oz. (5cc) of antioxidant and two each #12-24 x 1/2", M6 x 12mm, #10-32 x 1/2" and M5 x 12mm thread-forming screws.	1	10
RGEJ1024PFY	24 (0.61)	90°		1	10
RGEJ1036PFY	36 (0.91)	90°		1	10
RGEJ1024URT	24 (0.61)	Straight	#10 AWG (6mm ²) jumper, 24 in. (609.6mm) L, pre-terminated with two #10 (5.3mm) stud hole ring terminals to provide a bolt-on solution for grounding network equipment.	1	10

#6 AWG (16mm²) Equipment Jumpers Factory Terminated on Both Ends

RGEJ624PHY	24 (0.61)	45°	#6 AWG (16mm ²) jumper; bent lug on grounding strip side to straight lug on equipment; provided with .16 oz. (5cc) of antioxidant and two each #12-24 x 1/2", M6 x 12mm, #10-32 x 1/2" and M5 x 12mm thread-forming screws.	1	10
RGEJ624PFY	24 (0.61)	90°		1	10
RGEJ636PFY	36 (0.91)	90°		1	10
NEW! RGEJ660PF	60 (1.52)	90°	#6 AWG (16mm ²) jumper; bent lug on grounding strip side to straight lug on equipment.	1	10
NEW! RGEJ696PF	96 (2.44)	90°		1	10
RGEJ660U	60 (1.52)	Straight	#6 AWG (16mm ²) jumper, 60 in. (1524mm) L, pre-terminated with two straight slotted lugs to provide a bolt-on solution for grounding network equipment.	1	10
RGEJ696U	96 (2.44)	Straight	#6 AWG (16mm ²) jumper, 96 in. (2438.4mm) L, pre-terminated with two straight slotted lugs to provide a bolt-on solution for grounding network equipment.	1	10

#10 AWG (6mm²) Equipment Jumper Factory Terminated on One End

RGEJ1057PFY	57 (1.45)	90°	#10 AWG (6mm ²) jumper; bent lug on grounding strip side; provided with .16 oz. (5cc) of antioxidant and two each #12-24 x 1/2", M6 x 12mm, #10-32 x 1/2" and M5 x 12mm thread-forming screws.	1	10
-------------	-----------	-----	--	---	----

#6 AWG (16mm²) Equipment Jumper Factory Terminated on One End

RGEJ657PFY	57 (1.45)	90°	#6 AWG (16mm ²) jumper; bent lug on grounding strip side; provided with .16 oz. (5cc) of antioxidant and two each #12-24 x 1/2", M6 x 12mm, #10-32 x 1/2" and M5 x 12mm thread-forming screws.	1	10
------------	-----------	-----	--	---	----



Surge Suppressor Jumper Kit

- Bonds power or data line surge suppressor to grounding strip or grounding busbar
- Both ends factory terminated to provide a bolt-on solution
- Engineered to comply with US and International grounding requirements



Part Number	Part Description	Std. Pkg. Qty.
SSGK-1	#10 AWG (6mm ²) jumper; 24" (.61m) length; factory terminated on both ends; one-hole lug on surge suppressor to two-hole lug on grounding strip/busbar side; provided with .16 oz. (5cc) of antioxidant and two each #12-24 x 1/2", M6 x 12mm, #10-32 x 1/2" and M5 x 12mm thread-forming screws.	1

Armored Cable Grounding Kit

- Provides a secure bond to the armor sheath on indoor and indoor/outdoor fiber optic cables at both cassette and enclosure ends
- Worm-gear design evenly distributes forces across the armor
- Made from steel and aluminum material is compatible with common armor for long term reliability
- Black insulating cover protects and hides the connection for an aesthetically pleasing work area
- Complies with industry requirements ensuring a high level of reliability and safety



Part Number	Part Description	Std. Pkg. Qty.
ACG24K	#6 AWG (16mm ²) jumper for armored cable diameter up to 0.84" (21.3mm); 24" (609.6mm) length; factory terminated on one end with LCC6 two-hole copper compression lug and the other end with grounding terminal; provided with two each #12-24 and M6 thread-forming screws and a black polypropylene terminal cover.	1
ACG24K-500	#6 AWG (16mm ²) jumper for armored cable diameter 0.85" (21.3mm) to 1.03" (26.2mm); 24" (609.6mm) length; factory terminated on one end with LCC6 two-hole copper compression lug and the other end with grounding terminal; provided with two each #12-24 and M6 thread-forming screws and a black polypropylene terminal cover.	1
NEW! ACG24KX-500	#6 AWG (16mm ²) jumper for armored cable diameter 0.94" (23.9mm) to 1.5" (38.1mm); 24" (609.6mm) length; factory terminated on one end with LCC6 two-hole copper compression lug and the other end with grounding terminal; provided with two each #12-24 and M6 thread-forming screws and a black polypropylene terminal cover.	1
ACGK	Armored cable grounding kit with one grounding terminal for #6 AWG and one #10 mechanical clamp, 9/16" – 1 1/16" diameter range.	1
NEW! ACGKX	Armored cable grounding kit with one grounding terminal for #6 AWG and one #16 mechanical clamp, 15/16" – 1 1/2" diameter range.	1

Telecommunication Equipment Bonding Conductor (TEBC) Kits

- Bonds the rack or cabinet to the telecommunications grounding busbar (TGB)
- Jumper kit available with both ends factory terminated to provide a bolt-on solution
- Jumper kit available with one end factory terminated to attach to the rack or cabinet; free end accommodates unique length requirements
- Engineered to comply with US and international grounding requirements



Pre-Terminated on Both Ends

Part Number	Length		Angle	Part Description	Std. Pkg. Qty.
	In.	m			
Jumpers Pre-Terminated on Both Ends					
GJ672UH	72	1.83	Straight and 45°	One 72" length #6 AWG green wire with yellow horizontal stripe. Jumper is pre-terminated on one end with LCC6-14JAWH-L and the other end with LCC6-14JAW-L.	1
GJ696UH	96	2.44	Straight and 45°	One 96" length #6 AWG green wire with yellow horizontal stripe. Jumper is pre-terminated on one end with LCC6-14JAWH-L and the other end with LCC6-14JAW-L.	1
GJ6120UH	120	3.05	Straight and 45°	One 120" length #6 AWG green wire with yellow horizontal stripe. Jumper is pre-terminated on one end with LCC6-14JAWH-L and the other end with LCC6-14JAW-L.	1
GJ6144UH	144	3.66	Straight and 45°	One 144" length #6 AWG green wire with yellow horizontal stripe. Jumper is pre-terminated on one end with LCC6-14JAWH-L and the other end with LCC6-14JAW-L.	1
GJ6168UH	168	4.27	Straight and 45°	One 168" length #6 AWG green wire with yellow horizontal stripe. Jumper is pre-terminated on one end with LCC6-14JAWH-L and the other end with LCC6-14JAW-L.	1
GJ6192UH	192	4.88	Straight and 45°	One 192" length #6 AWG green wire with yellow horizontal stripe. Jumper is pre-terminated on one end with LCC6-14JAWH-L and the other end with LCC6-14JAW-L.	1
GJ6216UH	216	5.49	Straight and 45°	One 216" length #6 AWG green wire with yellow horizontal stripe. Jumper is pre-terminated on one end with LCC6-14JAWH-L and the other end with LCC6-14JAW-L.	1
GJ6240UH	240	6.10	Straight and 45°	One 240" length #6 AWG green wire with yellow horizontal stripe. Jumper is pre-terminated on one end with LCC6-14JAWH-L and the other end with LCC6-14JAW-L.	1
GJ6264UH	264	6.71	Straight and 45°	One 264" length #6 AWG green wire with yellow horizontal stripe. Jumper is pre-terminated on one end with LCC6-14JAWH-L and the other end with LCC6-14JAW-L.	1
GJ6288UH	288	7.32	Straight and 45°	One 288" length #6 AWG green wire with yellow horizontal stripe. Jumper is pre-terminated on one end with LCC6-14JAWH-L and the other end with LCC6-14JAW-L.	1

Table continues on page M.22

Telecommunication Equipment Bonding Conductor (TEBC) Kits (continued)

**Pre-Terminated on One End****Hardware for TEBC Kits**

Part Number	Length		Angle	Part Description	Std. Pkg. Qty.
	In.	m			
Jumpers Pre-Terminated on One End					
GJS6120U	120	3.05	Straight	One 120" length #6 AWG green wire with yellow horizontal stripe. Jumper is pre-terminated on one end with LCC6-14JAW-L.	1
GJS6180U	180	4.57	Straight	One 180" length #6 AWG green wire with yellow horizontal stripe. Jumper is pre-terminated on one end with LCC6-14JAW-L.	1

Part Number	Part Description	Std. Pkg. Qty.
Hardware for TEBC Kits		
HDW1/4-KT	Stainless steel mounting hardware for busbar; two 1/4-20 hex bolts, two 1/4-20 hex nuts, four 1/4 flat washers and two 1/4 Belleville compression washers. Mounting hardware for rack or cabinet; two #12-24 thread-forming screws and two M6 thread-forming screws.	1
HDW3/8-KT	Stainless steel mounting hardware for busbar; two 3/8-16 hex bolts, two 3/8-16 hex nuts, four 3/8 flat washers and two 3/8 Belleville compression washers. Mounting hardware for rack or cabinet; two #12-24 thread-forming screws and two M6 thread-forming screws.	1
HDW1/4-A-KT	Stainless steel mounting hardware for busbar; two 1/4-20 hex bolts, two 1/4-20 hex nuts, four 1/4 flat washers and two 1/4 Belleville compression washers. Mounting hardware for rack or cabinet; two #10-32 thread-forming screws and two M5 thread-forming screws.	1
HDW3/8-A-KT	Stainless steel mounting hardware for busbar; two 3/8-16 hex bolts, two 3/8-16 hex nuts, four 3/8 flat washers and two 3/8 Belleville compression washers. Mounting hardware for rack or cabinet; two #10-32 thread-forming screws and two M5 thread-forming screws.	1



Enclosure Grounding Kit

- Patented bracket provides equipotential bonding and protection from static electricity for equipment housed in enclosures
- A discrete grounding point for each piece of equipment within the enclosure allows equipment to be easily added or moved without disturbing other grounding connections
- Anti-rotation design prevents one-hole lugs from loosening

- Grounding washer provides a high performance electrical bond, eliminating the need to manually remove paint
- Built-in ESD port provides a convenient docking station for ESD wrist strap
- Provides proper bonding of PanZone® Active Wall Mount Enclosure PZAEWM3, see page E.5



Part Number	Part Description	Std. Pkg. Qty.
PZAEWK	One tin-plated copper bracket; 3.92" L x .56" W x .79" H (99.6mm x 14.2mm x 20.1mm); provided with four #12-24 screws, one each #10-32 and #10-24 hex nut, #10 split lock washer, grounding washer and ESD protection sticker.	1

Shielded Jack Module Grounding Kit

- Alternate method for grounding modules to another grounding wire in shielded applications



Part Number	Part Description	Std. Pkg. Qty.	Std. Ctn. Qty.
CJSGK-XY	Kit used to ground enhanced Giga-TX™ Style Shielded Jack Modules to another ground wire in shielded applications.	10	100

Electrostatic Discharge (ESD) Port Kits and Wrist Strap

- Accommodate standard ESD wrist strap 4mm plug
- Wrist strap provides rapid and continuous drain of electrostatic charge between a person and the surface that the wrist strap is bonded to, thus preventing damaging static discharge into equipment
- Can be mounted to front or back of rack or cabinet for convenient access

- Bent 45°, acts as a hook to hold wrist strap
- Two-hole configuration provides anti-rotation and prevents loss of bond
- Barrel permanently marked with the protective earth (ground) symbol
- Engineered to comply with US and International grounding requirements



RGESD2-1



RGESD2B-1



RGESDWS

Part Number	Part Description	Std. Pkg. Qty.	Std. Ctn. Qty.
ESD Port Kit for #12-24 or M6 Rail Fasteners			
RGESD2-1	Two-hole ESD port with 5/8" hole spacing; provided with an ESD protection sticker, .16 oz. (5cc) of antioxidant, and two each #12-24 x 1/2" and M6 x 12mm thread-forming screws.	1	20
ESD Port Kit for Cage Nut Rail Fasteners			
RGESD2B-1	Two-hole ESD port with 5/8" hole spacing; provided with an ESD protection sticker, .16 oz. (5cc) of antioxidant, two cage nut bonding studs and two #12-24 bonding nuts.	1	20
ESD Wrist Strap			
RGESDWS	Adjustable fabric ESD wrist strap with 6' coil cord, banana plug, 1 megohm resistor and 4mm snap.	1	—

ESD port must be attached to a grounded member.
ESD wrist strap sold separately.

PATENTED Bonding Screws

- Patented screws create an electrical bond between painted patch panels and racks or cabinets
- Serrations on bottom of screw remove paint from patch panel, providing metal-to-metal contact
- Available in two color options to meet different application needs
- Thread-forming, provides a bond to the rack or cabinet by removing paint from threaded holes and minimizing metal shavings
- Permanently marked with the protective earth (ground) symbol and Panduit logo
- Easily installed with Phillips screwdriver



Part Number	Part Description	Std. Pkg. Qty.
RGTBSG-C	Green thread-forming bonding screw, #12-24 x 1/2".	100
RGTBSM6G-C	Green thread-forming bonding screw, M6 x 15mm.	100
RGTBS1032G-C	Green thread-forming bonding screw, #10-32 x 1/2".	100
RGTBSM5G-C	Green thread-forming bonding screw, M5 x 15mm.	100

PATENTED Bonding Cage Nut

- Patented, creates an electrical bond between the mounting rails and equipment
- Conforms to EIA-310 specifications for racks and cabinets
- Made from high carbon steel
- Easily installed with a Phillips, flat blade, or nut screwdriver



Part Number	Part Description	Std. Pkg. Qty.
CNB4K	Green bonding cage nut, includes 4 #12-24 bonding cage nuts (.06 – .11 thick panel) and 4 #12-24 x 1/2" bonding screws with #2 Phillips/slotted combo hex head (use 5/16" or 8mm socket). Ideal for patch panel applications.	1
CNBK	Green bonding cage nut, includes 50 #12-24 bonding cage nuts (.06 – .11 thick panel) and 50 #12-24 x 1/2" bonding screws with #2 Phillips/slotted combo hex head (use 5/16" or 8mm socket).	1

Thread-Forming Screws

- Thread-forming, provide a bond to the rack or cabinet by removing paint from threaded holes and minimizing metal shavings
- Easily installed with 5/16" (8mm) socket head wrench or flat blade screwdriver



Part Number	Part Description	Std. Pkg. Qty.
RGTS-CY	Thread-forming grounding screw, #12-24 x 1/2".	100
RGTSM6-C	Thread-forming grounding screw, M6 x 12mm.	100
RGTS1032-C	Thread-forming grounding screw, #10-32 x 1/2".	100
RGTSM5-C	Thread-forming grounding screw, M5 x 12mm.	100

Paint Piercing Grounding Washer Kit

- Bonds frame members on bolt-together racks
- No paint scraping required
- Green color-coding to indicate bonding application
- Engineered to comply with US and International grounding requirements



Part Number	Part Description	Std. Pkg. Qty.
RGW-100-1Y	100 paint piercing bonding washers for 3/8" (M8) stud size; .875" (22.2mm) O.D.; provided with .16 oz. (5cc) of antioxidant.	1

PATENTED Bonding Hardware Kits

- Patented bonding hardware kits incorporate paint piercing serrations to create a bond point between the rack or cabinet and painted patch panels, mounted equipment, servers, busbars, and jumpers
- Thread-forming, provide a bond to the rack or cabinet by removing paint from holes and minimizing metal shavings
- Green color-coding to indicate bonding application

**TRBSK**

Part Number	Part Description	Std. Pkg. Qty.
Bonding Stud Kits for Threaded Rail Fasteners		
TRBSK	Bonding stud kit for threaded #12-24 rail fasteners; includes 25 bonding studs and 50 bonding nuts.	1
TRBSM6K	Bonding stud kit for threaded M6 rail fasteners; includes 25 bonding studs and 50 bonding nuts.	1

**CGNBSK**

Bonding Stud Kit for Cage Nut Rail Fasteners		
CGNBSK	Bonding stud kit for cage nut rail fasteners; includes 25 bonding studs and 50 bonding nuts.	1

Bonding Nuts		
BGN-C	Bonding nut for threaded #12-24, cage nut, and 1/4" thru-hole rail fasteners.	100
BGNM6-C	Bonding nut for threaded M6 rail fasteners.	100

**BGN**



Retrofit Cabinet Grounding Kits

- Provide a dedicated ground system to maintain system performance and protect network equipment when equipment is already installed
- Patented hardware incorporates paint piercing serrations to create a bond point between the cabinet rail, grounding busbar and lug; hardware never needs to be removed for new equipment installations
- Optimized for installation on 19" cabinets that meet EIA-310, with functioning equipment, and are deployed in the field
- Provides a complete system of matched components to save cost and labor
- Engineered to comply with US and International grounding requirements

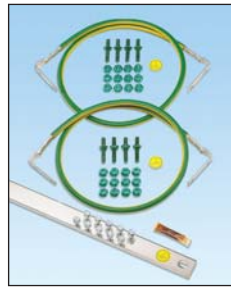
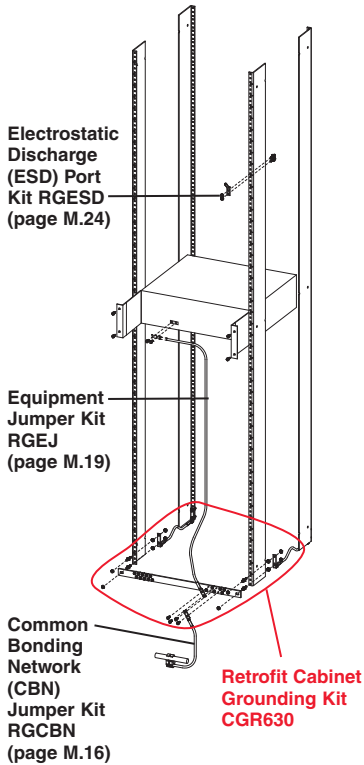

CGR630UB

Part Number	Part Description	Std. Pkg. Qty.
CGR630U	Retrofit grounding kit for installation on cabinets with threaded #12-24 or M6 rail fasteners and rail depth up to 30" (.75m); includes one RGRB19U grounding busbar kit and one CGJ630U front to back rail jumper kit.	1
CGR630UB	Retrofit grounding kit for installation on cabinets with cage nut rail fasteners and rail depth up to 30" (.75m); includes one RGRB19U grounding busbar kit and one CGJ630UB front to back rail jumper kit.	1



Retrofit Rack Grounding Kits

- Provide a dedicated ground system to maintain system performance and protect network equipment when equipment is already installed
- Provide a complete system of matched components that can be easily selected to save cost and labor
- Optimized for installation on 19" racks that meet EIA-310, with functioning equipment, and are deployed in the field
- Thread-forming screws eliminate the need to manually remove paint from the rack
- Engineered to comply with US and International grounding requirements

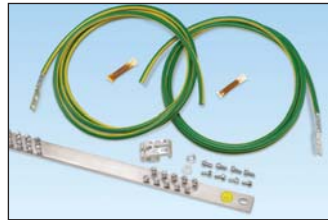
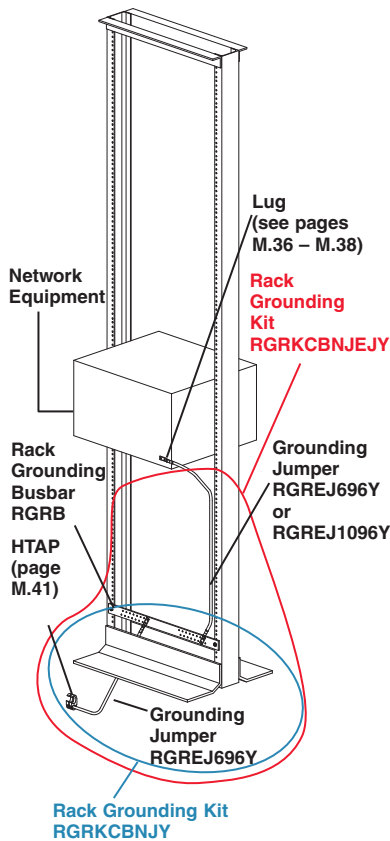

RGRKCBNJEJY

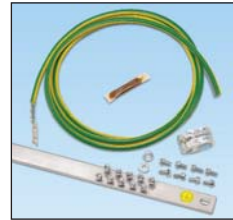

RGRKCBNJEJY

Part Number	Part Description	Std. Pkg. Qty.
Busbar and Jumper Kits		
RGRKCBNJEJY	Rack grounding kit to ground the rack and one piece of equipment; includes one RGRB19U busbar, one HTCT250-2-1 HTAP, and two RGREJ696Y grounding jumpers.	1
RGRKCBNJEJY	Rack grounding kit to ground the rack; includes one RGRB19U busbar, one HTCT250-2-1 HTAP, and one RGREJ696Y grounding jumper.	1
Busbar Kits		
RGRB19Y	Grounding busbar; 19" (483mm) length; tin-plated; fourteen holes arranged for flexibility in mounting; provided with two each #12-24 x 1/2" and M6 x 12mm thread-forming screws.	1
RGRB19U	Grounding busbar; 19" (483mm) length; tin-plated; twenty holes arranged for flexibility in mounting with twenty #12-24 x 1/2" hex head screws installed; mounting hole sets have 5/8" (15.9mm) spacing; provided with two each #12-24 x 1/2", M6 x 12mm thread-forming screws, and two #12 flat washers for mounting.	1
RGRB19CN	Grounding busbar; 19" (483mm) length; tin-plated; twenty holes arranged for flexibility in mounting with twenty #12-24 x 1/2" hex head screws installed; mounting hole sets have 5/8" (15.9mm) spacing; provided with two bonding cage nuts and four #12-24 bonding screws.	1
Equipment Jumper Kits		
RGREJ696Y	Grounding jumper; #6 AWG (16mm ²); 96" (2.44m) length; one end factory terminated to lug; provided with .16 oz. (5cc) of antioxidant and two each #12-24 x 1/2", M6 x 12mm, #10-32 x 1/2" and M5 x 12mm thread-forming screws.	1
RGREJ1096Y	Grounding jumper; #10 AWG (6mm ²); 96" (2.44m) length; one end factory terminated to lug; provided with .16 oz. (5cc) of antioxidant and two each #12-24 x 1/2", M6 x 12mm, #10-32 x 1/2" and M5 x 12mm thread-forming screws.	1

cUL^{us} BICSI/TIA-607-B Telecommunications Grounding Busbars

- Meet BICSI and TIA-607-B requirements for network systems grounding applications
- Made of high conductivity copper and tin-plated to inhibit corrosion
- Come pre-assembled with brackets and insulators attached for quick installation
- Use Panduit component labels, sold separately, to identify busbars to meet TIA-607-B, see chart below

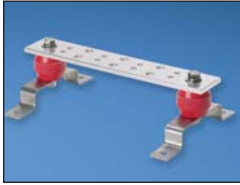

TGB



TMGB



Part Number	Bar Size	No. of Mounting Positions		Std. Pkg. Qty.
		1/4" Stud Hole with 5/8" Hole Spacing	3/8" Stud Hole with 1" Hole Spacing	

Telecommunications Grounding Busbars (TGB)

GB2B0304TPI-1	1/4" x 2" x 10"	4	3	1
GB2B0306TPI-1	1/4" x 2" x 12"	6	3	1
GB2B0312TPI-1	1/4" x 2" x 20"	12	3	1
GB2B0514TPI-1	1/4" x 2" x 24"	14	5	1

Telecommunications Main Grounding Busbars (TMGB)

GB4B0612TPI-1	1/4" x 4" x 12"	12	6	1
GB4B0624TPI-1	1/4" x 4" x 20"	24	6	1
GB4B1028TPI-1	1/4" x 4" x 24"	28	10	1

Telecommunications Grounding and Bonding Conductor Label Kit

Part Number	Part Description	Std. Pkg. Qty.
LTYK	Label kit includes printed tag and one flame retardant cable tie.	1

For complete labeling solutions and product information, reference charts on pages O.1 – O.25.

Component Labels for BICSI/TIA-607-B Telecommunications Grounding Busbars



1A-TMGB

Suggested Label Solutions for TIA-607-B Compliance

Telecommunications Grounding Busbar Part Number	Laser/Ink Jet Desktop Printer Label	TDP43ME Thermal Transfer Desktop Printer Label	PanTher™ LS8E Hand-Held Printer Label	Cougar™ LS9 Hand-Held Printer Label
All GB2B and GB4B Parts	C200X100FJJ	C200X100YPT	C200X100FJC	T100X000VPC-BK

cUL^{us} NEMA Hole Pattern Grounding Busbars

- Provided with standard NEMA hole pattern spacing
- Made of high conductivity copper and tin-plated to inhibit corrosion
- Come pre-assembled with brackets and insulators attached for quick installation
- Insulators provide 600 V of insulation



Part Number	Bar Size	No. of Mounting Positions	
		1/2" Stud Hole with 1 3/4" Hole Spacing	Std. Pkg. Qty.
GB4N0007TPI-1	1/4" x 4" x 12"	7	1
GB4N0016TPI-1	1/4" x 4" x 24"	16	1
GB4N0024TPI-1	1/4" x 4" x 36"	24	1
GB4N0026TPI-1	1/4" x 4" x 48"	26	1
GB4N0034TPI-1	1/4" x 4" x 60"	34	1

cUL^{us} Grounding Busbar 1 Inch Hole Spacings

- Provided with 1 inch hole D pattern spacing
- Made of high conductivity copper and tin-plated to inhibit corrosion
- Come pre-assembled with brackets and insulators attached for quick installation
- Insulators provide 600 V of insulation



Part Number	Bar Size	No. of Mounting Positions	
		3/8" Stud Hole with 1" Hole Spacing	Std. Pkg. Qty.
GB2D0008TPI-1	1/4" x 2" x 12"	8	1
GB2D0021TPI-1	1/4" x 2" x 24"	21	1
GB2D0033TPI-1	1/4" x 2" x 36"	33	1
GB2D0044TPI-1	1/4" x 2" x 48"	44	1
GB2D0056TPI-1	1/4" x 2" x 60"	56	1

Busbar Type	Busbar Pattern
BICSI	B
GB2D...series	D
NEMA	N

See pages M.36 – M.38 for Lug information



Universal Beam Grounding Clamp



- Universal, fits on a wide range of standard (angled) and wide flange (parallel) structural steel beams
- Provide a mounting pad suitable for a two-hole compression lug
- Install quickly and easily with standard 1/4" key hex wrench tooling
- UL 467 Listed and CSA 22.2 Certified for grounding and bonding suitable for direct burial in earth or concrete
- Comply with vibration tests per MIL-STD-202G (METHOD 201A)
- For the complete line of StructuredGround™ Direct Burial Compression Grounding System, visit www.panduit.com

Part Number	Copper Conductor Size Range AWG	Flange Thickness In.	Stud Size In.	Hole Spacing In.	Thread Size	Length In.	Width In.	Height In.	Std. Pkg. Qty.
GUBC500-6	#6 – 500	0.250 – 0.675	1/2	1.75	1/2 – 13	3.15	2.13	2.50	1



Auxiliary Cable Brackets and Jumpers

- Bonds ladder rack, wire basket and Panduit® Wyr-Grid® System sections together without drilling holes
- Supports grounding conductors in the telecommunications room, allows separation of grounding conductors from other cables
- Holds up to four conductors in sizes up to 750 kcmil
- Bonds to all 1" and 2" ladder rack rails
- Paint piercing teeth provide electrical continuity between cable pathway sections while minimizing debris
- Front and back mounting screw options allow easy installation and visual inspection
- GACB-2 and GACB-3 can be mounted above or below the cable pathway system for flexibility
- Brackets Meet TIA-607-B



GACB



GACB-2



GACB-3

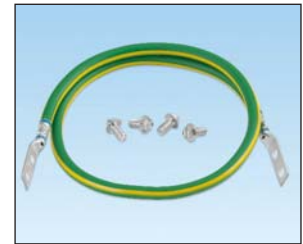

GACBJ618U

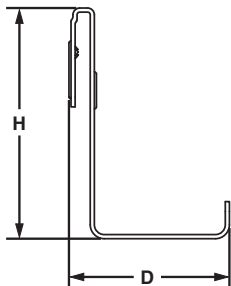
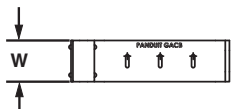

Part Number	Part Description	Std. Pkg. Qty.	Std. Ctn. Qty.
-------------	------------------	----------------	----------------

Auxiliary Cable Brackets

GACB-1	Auxiliary cable bracket; 1.25" (31.8mm) width; 7.00" (177.8mm) height; 4.87" (123.7mm) depth; provided with one mounting screw.	1	10
GACB-2	Auxiliary cable bracket; 1.63" (41.4mm) width, 3.95" (100.3mm) height, 5.22" (132.6mm) depth; provided with one mounting screw.	1	10
GACB-3	Auxiliary cable bracket; 1.88" (47.6mm) width, 4.58" (116.3mm) height, 5.29" (134.4mm) depth; provided with one mounting screw.	1	10

Bonding Jumper Kits

GACBJ68U	Auxiliary cable bracket jumper for bonding pathway sections; #6 AWG (16mm ²); 8.0" (203mm) length; factory terminated on both ends with straight, two-hole, long barrel compression lugs; provided with .16 oz. (5cc) of antioxidant and four mounting screws.	1	—
GACBJ612U	Auxiliary cable bracket jumper for bonding pathway sections; #6 AWG (16mm ²); 12.0" (305mm) length; factory terminated on both ends with straight, two-hole, long barrel compression lugs; provided with .16 oz. (5cc) of antioxidant and four mounting screws.	1	—
GACBJ618U	Auxiliary cable bracket jumper for bonding pathway sections; #6 AWG (16mm ²); 18.0" (457mm) length; factory terminated on both ends with straight, two-hole, long barrel compression lugs; provided with .16 oz. (5cc) of antioxidant and four mounting screws.	1	—

**DB**
RATED**One-Hole Grounding Lay-In Lug**

- Used for quick installation of a continuous grounding conductor
- UL 467 Listed for grounding and bonding, copper lugs
UL Listed for direct burial in earth or concrete

- UL Listed for use up to 600 V and temperature rated 90°C
- Wide wire range-taking capability minimizes inventory requirements

**Copper****Tin-Plated Copper****Aluminum**

Part Number	Set Screw Material	Conductor Size Range	Stud Hole Size In.	Hex Key Size In.	Length In.	Width In.	Height In.	Std. Pkg. Qty.
Copper Body								
LICC4-22-C	Stainless Steel	#14 AWG – #4 AWG	0.22	**	1.09	0.39	0.75	100
Tin-Plated Copper Body								
LICC4-22TP-C	Stainless Steel	#14 AWG – #4 AWG	0.22	**	1.09	0.39	0.75	100
Tin-Plated Aluminum Body								
LIAC4-22-C	Stainless Steel	#14 AWG – #4 AWG	0.22	**	1.06	0.39	0.78	100
LIAS1/0-14-L	Zinc Plated Steel	#14 AWG – 1/0 AWG	0.27	**	1.50	0.61	1.10	50
LIAS250-56-Q	Zinc Plated Steel	#6 AWG – 250 kcmil	0.33	1/4	2.20	0.80	1.70	25

**Uses slotted head set screw.

The use of Panduit oxide inhibiting joint compound (CMP) is recommended for pad to conductor connections. Refer to www.panduit.com for more information.



Ring Terminal, Vinyl Expanded Insulation

- Expanded wire entry designed to accommodate wire with a larger insulation thickness
- Ring tongue design assures a secure connection in high vibration applications
- Insulation support helps to prevent wire damage in bending applications
- Brazed seam protects terminal barrel from splitting during the crimp process
- Internal barrel serrations assure good wire contact and maximum tensile strength
- UL Flammability UL 94V-0, maximum insulation temperature 221°F (105°C)
- UL and CSA rated up to 600 V per UL 486A/B

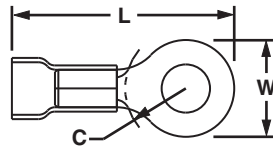

Part Number	Wire Range		Color Code	Max. Ins. Dia.		Stud Size		Length		Width		Clearance		Panduit Crimping Tool	Std. Pkg. Qty.	Std. Ctn. Qty.
	AWG	mm ²		In.	mm	In.	mm	In.	mm	In.	mm	In.	mm			
PV14-8RX-C	16 – 14 AWG	1.5 – 2.5	Blue	0.200	5.1	#8	M4	0.96	24.4	0.31	7.9	0.25	6.4	CT-100A‡, CT-600-A‡, CT-1550‡, CT-1551‡, CT-2500‡	100	500
PV14-10RX-C				0.200	5.1	#10	M5	0.96	24.4	0.31	7.9	0.25	6.4		100	500
PV14-14RX-L				0.200	5.1	1/4"	M6	1.16	29.5	0.46	11.7	0.37	9.4		50	500
PV14-56RX-L				0.200	5.1	5/16"	M8	1.16	29.5	0.46	11.7	0.37	9.4		50	500
PV14-38RX-L				0.200	5.1	3/8"	M10	1.25	31.8	0.53	13.5	0.42	10.7		50	500
PV10-8RX-L	12 – 10 AWG	4.0 – 6.0	Yellow	0.250	6.4	#8	M4	1.10	27.9	0.31	7.9	0.30	7.6	CT-100A‡, CT-600-A‡, CT-1550‡, CT-1551‡, CT-2500‡	50	500
PV10-10RX-L				0.250	6.4	#10	M5	1.10	27.9	0.31	7.9	0.30	7.6		50	500
PV10-14RX-L				0.250	6.4	1/4"	M6	1.29	32.8	0.52	13.2	0.39	9.9		50	500
PV10-56RX-L				0.250	6.4	5/16"	M8	1.29	32.8	0.52	13.2	0.42	10.7		50	500
PV10-38RX-L				0.250	6.4	3/8"	M10	1.35	34.3	0.58	14.7	0.46	11.7		50	500
PV8-10RX-QY	8 AWG	10.0	Red	0.360	9.1	#10	M5	1.52	38.6	0.47	11.9	0.43	10.9	CT-720 with Die Insert CD-720PV8-2‡, CT-2600 with Die Insert CD-2600-PV8‡	25	250
PV8-14RX-QY				0.360	9.1	1/4"	M6	1.52	38.6	0.47	11.9	0.43	10.9		25	250
PV8-56RX-QY				0.360	9.1	5/16"	M8	1.62	41.2	0.59	15.0	0.51	13.0		25	250
PV8-38RX-QY				0.360	9.1	3/8"	M10	1.62	41.2	0.59	15.0	0.51	13.0		25	250
PV8-12RX-XY				0.360	9.1	1/2"	M12	1.74	44.2	0.82	20.8	0.51	13.0		10	100
PV6-10RX-X	6 AWG	16.0	Blue	0.436	11.1	#10	M5	1.61	40.9	0.47	11.9	0.43	10.9	CT-720 with Die Insert CD-720PV8-2‡, CT-2600 with Die Insert CD-2600-PV6‡	10	100
PV6-14RX-X				0.436	11.1	1/4"	M6	1.61	40.9	0.47	11.9	0.43	10.9		10	100
PV6-56RX-X				0.436	11.1	5/16"	M8	1.73	43.9	0.62	15.8	0.51	13.0		10	100
PV6-38RX-X				0.436	11.1	3/8"	M10	1.73	43.9	0.62	15.8	0.53	13.5		10	100
PV4-14RX-E	4 AWG	25.0	Yellow	0.515	13.1	1/4"	M6	1.87	47.5	0.55	14.0	0.53	13.5	CT-720 with Die Insert CD-720PV8-2‡, CT-2600 with Die Insert CD-2600-PV4‡	20	200
PV4-56RX-E				0.515	13.1	5/16"	M8	1.94	49.3	0.68	17.3	0.53	13.5		20	200
PV4-38RX-E				0.515	13.1	3/8"	M10	1.94	49.3	0.68	17.3	0.53	13.5		20	200
PV4-12RX-E				0.515	13.1	1/2"	M12	2.03	51.6	0.86	21.8	0.53	13.5		20	200
PV2-14RX-XY	2 AWG	35.0	Red	0.632	16.1	1/4"	M6	1.94	49.3	0.68	17.3	0.58	14.7	CT-720 with Die Insert CD-720PV8-2‡, CT-2600 with Die Insert CD-2600-PV2‡	10	100
PV2-56RX-XY				0.632	16.1	5/16"	M8	1.94	49.3	0.68	17.3	0.58	14.7		10	100
PV2-38RX-XY				0.632	16.1	3/8"	M10	1.94	49.3	0.68	17.3	0.58	14.7		10	100
PV2-12RX-XY				0.632	16.1	1/2"	M12	2.03	51.6	0.86	21.8	0.58	14.7		10	100

‡UL and CSA approved tooling/product combinations.
 For crimping tool information, see page M.46.
 For the full selection of Panduit Crimping Tools see www.panduit.com.

UL LISTED CERTIFIED Ring Terminal, Nylon Insulated – Funnel Entry

- Ring tongue design assures a secure connection in high vibration applications
- Metal insulation grip sleeve crimps to wire insulation, providing protection to the crimp joint during high vibration applications

- Internal barrel serrations assure good wire contact and maximum tensile strength
- UL Flammability UL 94V-2/HB, maximum insulation temperature 221°F (105°C)
- UL and CSA rated up to 600 V per UL 486A/B

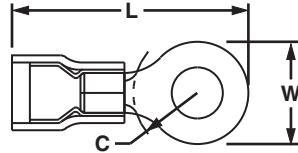

Part Number	Wire Range		Color Code	Max. Ins.		Stud Size		Length		Width		Clearance		Panduit Crimping Tool	Std. Pkg. Qty.	Std. Ctn. Qty.
	AWG	mm ²		In.	mm	In.	mm	In.	mm	In.	mm	In.	mm			
PNF14-8R-C	16 – 14 AWG	1.5 – 2.5	Blue	0.162	4.12	#8	M4	0.87	22.1	0.31	7.9	0.25	6.4	CT-100A‡, CT-600-A‡, CT-1550‡, CT-1551‡, CT-2500‡	100	500
PNF14-10R-C				0.162	4.12	#10	M5	0.85	21.6	0.31	7.9	0.29	7.4		100	500
PNF14-14R-C				0.162	4.12	1/4"	M6	1.06	26.9	0.46	11.7	0.40	10.2		100	500
PNF14-56R-C				0.162	4.12	5/16"	M8	1.06	26.9	0.46	11.7	0.40	10.2		100	500
PNF14-38R-L	12 – 10 AWG	4.0 – 6.0	Yellow	0.162	4.12	3/8"	M10	1.14	29.0	0.53	13.5	0.45	11.4	CT-100A‡, CT-600-A‡, CT-1550‡, CT-1551‡, CT-2500‡	50	500
PNF10-8R-L				0.225	5.75	#8	M4	1.06	26.9	0.37	9.4	0.31	7.9		50	500
PNF10-10R-L				0.225	5.75	#10	M5	1.06	26.9	0.37	9.4	0.31	7.9		50	500
PNF10-14R-L				0.225	5.75	1/4"	M6	1.21	30.7	0.52	13.2	0.38	9.7		50	500
PNF10-56R-L				0.225	5.75	5/16"	M8	1.21	30.7	0.52	13.2	0.38	9.7		50	500
PNF10-38R-L	0.225	5.75	3/8"	M10	1.29	32.8	0.58	14.7	0.43	10.9	50	500				

‡UL and CSA approved tooling/product combinations.
 For crimping tool information, see page M.46.
 For the full selection of Panduit Crimping Tools see www.panduit.com.

UL LISTED CERTIFIED Multiple Stud Terminal, Nylon Insulated

- Teardrop shaped mounting hole of multiple stud terminals permits use with #6, #8, or #10 size studs
- Ring tongue design assures a secure connection in high vibration applications
- Metal insulation grip sleeve crimps to wire insulation, providing protection to the crimp joint during high vibration applications

- Internal barrel serrations assure good wire contact and maximum tensile strength
- UL Flammability UL 94V-2/HB, maximum insulation temperature 221°F (105°C)
- UL and CSA rated up to 600 V per UL 486A/B

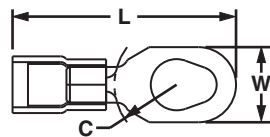

Part Number	Wire Range		Color Code	Max. Ins.		Stud Size		Length		Width		Clearance		Panduit Crimping Tool	Std. Pkg. Qty.	Std. Ctn. Qty.
	AWG	mm ²		In.	mm	In.	mm	In.	mm	In.	mm	In.	mm			
PN14-610R-C	16 – 14 AWG	1.5 – 2.5	Blue	0.165	4.25	#6, #8, #10	M3.5 – M5	0.95	24.1	0.31	7.9	0.25	6.4	CT-100A‡, CT-600-A‡, CT-1550‡, CT-1551‡, CT-2500‡, CT-400, CT-460	100	500
PN10-610R-L	12 – 10 AWG	4.0 – 6.0	Yellow	0.225	5.75	#6, #8, #10	M3.5 – M5	1.17	29.7	0.37	9.4	0.33	8.4	CT-100A‡, CT-600-A‡, CT-1550‡, CT-1551‡, CT-2500‡, CT-460	50	500

‡UL and CSA approved tooling/product combinations.
 For crimping tool information, see page M.46.
 For the full selection of Panduit Crimping Tools see www.panduit.com.



Ring Terminal, Non-Insulated

- Ring tongue design assures a secure connection in high vibration applications
- Internal barrel serrations assure good wire contact and maximum tensile strength
- Brazed seam protects terminal barrel from splitting during the crimp process

- Barrel of terminal internally beveled to provide quick and easy wire insertion
- Maximum recommended operating temperature 302°F (150°C)
- UL and CSA rated up to 2000 V per UL 486A/B, where applicable

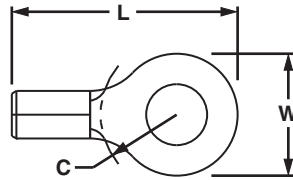

Part Number	Wire Range		Stud Size		Length		Width		Clearance		Panduit Crimping Tool	Std. Pkg. Qty.	Std. Ctn. Qty.
	AWG	mm ²	In.	mm	In.	mm	In.	mm	In.	mm			
P14-8R-C	18 – 14 AWG	1.0 – 2.5	#8	M4	0.71	18.0	0.31	7.9	0.25	6.4	CT-100A‡, CT-200‡, CT-600-A‡, CT-1570‡, CT-2500‡	100	1000
P14-10R-C			#10	M5	0.71	18.0	0.31	7.9	0.25	6.4		100	1000
P14-14R-C			1/4"	M6	0.91	23.1	0.46	11.7	0.38	9.7		100	1000
P14-56R-C			5/16"	M8	0.91	23.1	0.46	11.7	0.38	9.7		100	1000
P14-38R-C			3/8"	M10	1.0	25.4	0.53	13.5	0.43	10.9		100	1000
P14-12R-L			1/2"	M12	1.20	30.5	0.72	18.3	0.53	13.5		50	500
P10-8R-L	14 – 10 AWG	2.5 – 6.0	#8	M4	0.78	19.8	0.31	7.9	0.31	7.9	CT-100A‡, CT-200‡, CT-600-A‡, CT-1570‡, CT-1701‡, CT-2500‡	50	500
P10-10R-L			#10	M5	0.81	20.6	0.38	9.7	0.31	7.9		50	500
P10-14R-L			1/4"	M6	0.96	24.4	0.52	13.2	0.38	9.7		50	500
P10-56R-L			5/16"	M8	0.96	24.4	0.52	13.2	0.38	9.7		50	500
P10-38R-L			3/8"	M10	1.05	26.7	0.58	14.7	0.44	11.2		50	500
P10-12R-L			1/2"	M12	1.20	30.5	0.72	18.3	0.53	13.5		50	500
P8-10R-Q	8 AWG	10.0	#10	M5	1.14	29.0	0.47	11.9	0.43	10.9	CT-1701‡, CT-2600 with Die Insert CD-2600-8‡	25	250
P8-14R-Q			1/4"	M6	1.14	29.0	0.47	11.9	0.43	10.9		25	250
P8-56R-Q			5/16"	M8	1.25	31.8	0.59	15.0	0.51	13.0		25	250
P8-38R-Q			3/8"	M10	1.25	31.8	0.59	15.0	0.51	13.0		25	250
P8-12R-Q			1/2"	M12	1.36	34.5	0.82	20.8	0.54	13.7		25	250
P6-10R-E	6 AWG	16.0	#10	M5	1.21	30.7	0.47	11.9	0.43	10.9	CT-1701‡, CT-2600 with Die Insert CD-2600-6‡	20	200
P6-14R-E			1/4"	M6	1.21	30.7	0.47	11.9	0.43	10.9		20	200
P6-56R-E			5/16"	M8	1.33	33.8	0.62	15.7	0.51	13.0		20	200
P6-38R-E			3/8"	M10	1.33	33.8	0.62	15.7	0.51	13.0		20	200
P6-12R-E			1/2"	M12	1.43	36.3	0.82	20.8	0.51	13.0		20	200
P4-14R-E	4 AWG	25.0	1/4"	M6	1.40	35.6	0.55	14.0	0.50	12.7	CT-1701‡, CT-2600 with Die Insert CD-2600-4‡	20	200
P4-56R-E			5/16"	M8	1.46	37.1	0.68	17.3	0.50	12.7		20	200
P4-38R-E			3/8"	M10	1.46	37.1	0.68	17.3	0.50	12.7		20	200
P4-12R-E			1/2"	M12	1.55	39.4	0.86	21.8	0.53	13.5		20	200
P2-14R-X	2 AWG	35.0	1/4"	M6	1.46	37.1	0.68	17.3	0.58	14.7	CT-1701‡, CT-2600 with Die Insert CD-2600-4‡	10	100
P2-56R-X			5/16"	M8	1.46	37.1	0.68	17.3	0.58	14.7		10	100
P2-38R-X			3/8"	M10	1.46	37.1	0.68	17.3	0.58	14.7		10	100
P2-12R-X			1/2"	M12	1.55	39.4	0.86	21.8	0.58	14.7		10	100

‡UL and CSA approved tooling/product combinations.
For crimping tool information, see page M.46.
For the full selection of Panduit Crimping Tools see www.panduit.com.



Code Conductor, Two-Hole, Long Barrel with Window Lug

For Use with Stranded Copper Conductors



- Meets TIA-607-B requirements for network systems grounding applications
- **Tested by Telcordia – meets NEBS Level 3 with AWG conductor**
- Requires crimping tools and dies, see pages M.46 – M.49
- UL Listed and CSA Certified with AWG conductor for use up to 35 KV** and temperature rated 90°C when crimped with Panduit and specified competitor crimping tools and dies

- Color-coded barrels marked with Panduit and specified competitor die index numbers for proper crimp die selection
- Long barrel maximizes number of crimps and provides premium wire pull-out strength and electrical performance
- Inspection window to visually assure full conductor insertion
- Tin-plated to inhibit corrosion
- Available with NEMA hole sizes and spacing

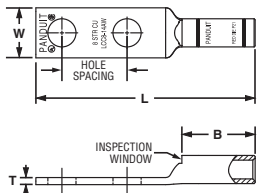

Figure 1: Straight

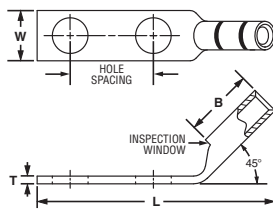

Figure 2: 45° Bent

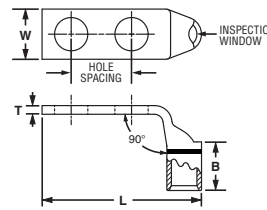

Figure 3: 90° Bent

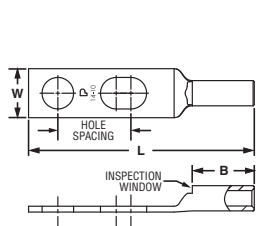

Figure 4: Slotted, Straight

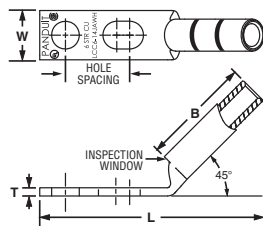

Figure 5: Slotted, 45° Bent

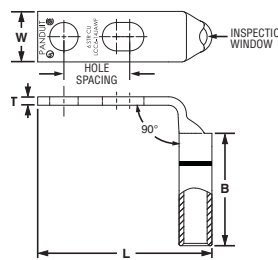

Figure 6: Slotted, 90° Bent

Part Number	Figure No.	Copper Conductor Size	Stud Hole Size In.	Stud Hole Spacing In.	Figure Dimensions In.			Panduit Crimping Tool‡	Panduit Die Color and Die No.‡	Wire Strip Length In.	Busbar Pattern^	Std. Pkg. Qty.
					W	B	L					
LCC10-14JAW-L*	4	#14 – #10 AWG STR, #12 – #10 AWG SOL	1/4	0.50 – 0.63	0.42	0.53	1.93	CT-1570, CT-1701	—	9/16	B	50
LCC10-14JAWH-L*	5		1/4	0.50 – 0.63	0.42	0.53	1.78				B	50
LCC10-14JAWF-L*	6		1/4	0.50 – 0.63	0.42	0.53	1.56				B	50
LCC10-14AW-L*	1		1/4	0.63	0.42	0.53	1.93				B	50
LCC8-10AW-L	1	#8 AWG	#10	0.63	0.41	0.70	2.01	CT-1700, CT-930, CT-2930/L, CT-2930/LE	Red P21	3/4	B	50
LCC8-14AWH-L	2		1/4	0.63	0.48	0.70	1.91				B	50
LCC8-14AWF-L	3		1/4	0.63	0.48	0.70	1.61				B	50
LCC8-38DW-L	1		3/8	1.00	0.60	0.70	2.70				B, D	50

‡See pages M.50 – M.53 for Panduit and competitor tool and die information.

*Not tested to NEBS Level 3 requirements.

**Consult cable manufacturer for voltage stress relief instructions with applications greater than 2000 V.

^See page M.30 for busbar patterns.

◆NEMA hole sizes and spacing.



Code Conductor, Two-Hole, Long Barrel with Window Lug (continued)

Part Number	Figure No.	Copper Conductor Size	Stud Hole Size In.	Stud Hole Spacing In.	Figure Dimensions In.			Panduit Crimping Tool‡	Panduit Die Color and Die No.‡	Wire Strip Length In.	Busbar Pattern^	Std. Pkg. Qty.
					W	B	L					
LCC6-10ABW-L	4	#6 AWG	#10	0.63 – 0.75	0.46	1.07	2.52	CT-1700, CT-930, CT-2930/L, CT-2930/LE	Blue P24	1 1/8	B	50
LCC6-14JAW-L	4		1/4	0.50 – 0.63	0.48	1.07	2.49				B	50
LCC6-14JAWH-L	5		1/4	0.50 – 0.63	0.48	1.07	2.08				B	50
LCC6-14JAWF-L	6		1/4	0.50 – 0.63	0.48	1.07	1.66				B	50
LCC6-14AW-L	1		1/4	0.63	0.48	1.07	2.49				B	50
LCC6-38DW-L	1		3/8	1.00	0.62	1.07	3.08				B, D	50
LCC6-12W-L	1		1/2	1.75	0.75	1.07	3.97				N	50
LCC4-14AW-L	1	#4 – #3 AWG STR, #2 AWG SOL	1/4	0.63	0.55	1.05	2.50	CT-1700, CT-930, CT-2930/L, CT-2930/LE	Gray P29	1 1/8	B	50
LCC4-38DW-L	1		3/8	1.00	0.62	1.05	3.09				B, D	50
LCC4-12W-L	1		1/2	1.75	0.75	1.05	4.01				N	50
LCC2-14AW-Q	1	#2 AWG	1/4	0.63	0.60	1.16	2.67	CT-1700, CT-930, CT-2930/L, CT-2930/LE	Brown P33	1 1/4	B	25
LCC2-38DW-Q	1		3/8	1.00	0.66	1.16	3.24				B, D	25
LCC2-12W-Q	1		1/2	1.75	0.75	1.16	4.41				N	25
LCC1/0-14AW-X	1	1/0 AWG	1/4	0.63	0.76	1.44	3.07	CT-930, CT-2930/L, CT-2930/LE	Pink P42	1 1/2	B	10
LCC1/0-38DW-X	1		3/8	1.00	0.76	1.44	3.57				B, D	10
LCC1/0-12W-X	1		1/2	1.75	0.80	1.44	4.74				N	10
LCC2/0-14AW-X	1	2/0 AWG	1/4	0.63	0.85	1.50	3.23	CT-930, CT-2930/L, CT-2930/LE	Black P45	1 9/16	B	10
LCC2/0-38DW-X	1		3/8	1.00	0.85	1.50	3.67				B, D	10
LCC2/0-12W-X	1		1/2	1.75	0.85	1.50	4.83				N	10
LCC3/0-38DW-X	1	3/0 AWG	3/8	1.00	0.96	1.50	3.70	CT-930, CT-2930/L, CT-2930/LE	Orange P50	1 9/16	B, D	10
LCC3/0-12W-X	1		1/2	1.75	0.96	1.50	4.87				N	10
LCC4/0-38DW-X	1	4/0 AWG	3/8	1.00	1.06	1.56	3.81	CT-930, CT-2930/L, CT-2930/LE	Purple P54	1 5/8	N	10
LCC4/0-12W-X	1		1/2	1.75	0.96	1.56	3.81				N	10
LCC250-38DW-X	1	250 kcmil	3/8	1.00	1.17	1.61	3.89	CT-930, CT-2930/L, CT-2930/LE	Yellow P62	1 11/16	B, D	10
LCC250-12W-X	1		1/2	1.75	1.17	1.61	4.12				N	10

‡See pages M.50 – M.53 for Panduit and competitor tool and die information.

*Not tested to NEBS Level 3 requirements.

**Consult cable manufacturer for voltage stress relief instructions with applications greater than 2000 V.

^See page M.30 for busbar patterns.

◆NEMA hole sizes and spacing.

Table continues on page M.38

**Code Conductor, Two-Hole, Long Barrel with Window Lug
(continued)**

Part Number	Figure No.	Copper Conductor Size	Stud Hole Size In.	Stud Hole Spacing In.	Figure Dimensions In.			Panduit Crimping Tool‡	Panduit Die Color and Die No.‡	Wire Strip Length In.	Busbar Pattern [^]	Std. Pkg. Qty.
					W	B	L					
◆ LCC350-12W-X	1	350 kcmil	1/2	1.75	1.28	2.24	5.76	CT-930, CT-2930/L, CT-2930/LE	Red P71	2 5/16	N	10
LCC350-38DW-X	1		3/8	1.00	1.28	2.24	4.58		Red P71		B, D	10
◆ LCC400-12W-6	1	400 kcmil	1/2	1.75	1.28	2.30	5.84	CT-930, CT-2930/L, CT-2930/LE	Blue P76	2 3/8	N	6
LCC400-38DW-6	1		3/8	1.00	1.39	2.30	4.66		Blue P76		B, D	6
◆ LCC500-12W-6	1	500 kcmil	1/2	1.75	1.54	2.50	6.12	CT-930, CT-2930/L, CT-2930/LE	Brown P87	2 9/16	N	6
LCC500-38DW-6	1		3/8	1.00	1.54	2.50	4.94		Brown P87		B, D	6
◆ LCC600-12W-6	1	600 kcmil	1/2	1.75	1.70	2.69	6.36	CT-930, CT-2930/L, CT-2930/LE	Green P94	2 3/4	N	6
LCC600-38DW-6	1		3/8	1.00	1.70	2.69	5.18		Green P94		B, D	6
◆ LCC750-12W-6	1	750 kcmil	1/2	1.75	1.89	2.88	6.65	CT-930, CT-2930/L, CT-2930/LE	Black P106	2 15/16	N	6
LCC750-38DW-6	1		3/8	1.00	1.89	2.88	5.71		Black P106		B, D	6

‡See pages M.50 – M.53 for Panduit and competitor tool and die information.

*Not tested to NEBS Level 3 requirements.

**Consult cable manufacturer for voltage stress relief instructions with applications greater than 2000 V.

^See page M.30 for busbar patterns.

◆NEMA hole sizes and spacing.



Flex Conductor, Two-Hole, Long Barrel with Window Lug

For Use with Flexible, Extra-Flexible, and Code Stranded Copper Conductors



- Meets TIA-607-B requirements for network systems grounding applications
- Requires crimping tools and dies, see pages M.46 – M.49
- UL Listed and CSA Certified with AWG conductor for use up to 35 KV** and temperature rated 90°C when crimped with Panduit and specified competitor crimping tools and dies
- Color-coded barrels marked with Panduit and specified competitor die index numbers for proper crimp die selection
- Can be used with code conductor and flex conductor class: G, H, I, K, M and Diesel Locomotive
- Long barrel maximizes number of crimps and provides premium wire pull-out strength and electrical performance
- Inspection window to visually assure full conductor insertion
- Generously beveled wire entry prevents bent back strands when inserting conductor into barrel
- Tin-plated to inhibit corrosion
- Available with NEMA hole sizes and spacing

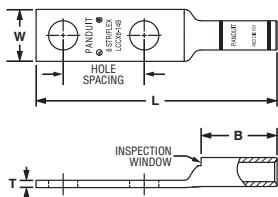

Figure 1: Straight

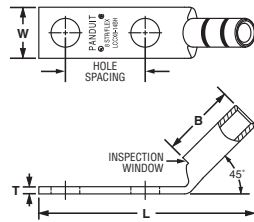

Figure 2: 45° Bent

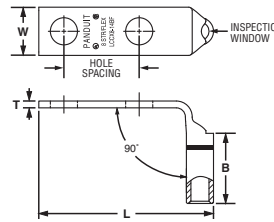

Figure 3: 90° Bent

Part Number	Fig. No.	Flex Conductor Size		Code Conductor Size	Stud Hole Size In.	Stud Hole Spacing In.	Figure Dimensions In.			Panduit Crimping Tool‡	Panduit Die Color & Die No.‡	Wire Strip Length In.	Busbar Pattern^	Std. Pkg. Qty.
		Class G, H, I, K, M	Diesel Locomotive				W	B	L					
LCCX8-14A-L	1	#8 AWG	#8 AWG	#8 AWG	1/4	0.63	0.48	0.70	2.10	CT-1700, CT-930, CT-2930/L, CT-2930/LE	Red P21	3/4	B	50
LCCX8-14AH-L	2				1/4	0.63	0.48	0.70	1.91					50
LCCX8-14AF-L	3				1/4	0.63	0.48	0.70	1.62					50
LCCX8-38D-L	1				3/8	1.00	0.60	0.70	2.70					B, D
LCCX6-14A-L	1	#6 AWG	#6 AWG	#6 AWG	1/4	0.63	0.48	1.07	2.49	CT-1700, CT-930, CT-2930/L, CT-2930/LE	Blue P24	1 1/8	B	50
LCCX6-14AH-L	2				1/4	0.63	0.48	1.07	2.18					50
LCCX6-14AF-L	3				1/4	0.63	0.48	1.07	1.66					50
LCCX6-38D-L	1				3/8	1.00	0.62	1.07	3.08					B, D

‡See pages M.54 and M.55 for Panduit and competitor tool and die information.

**Consult cable manufacturer for voltage stress relief instructions with applications greater than 2000 V.

^See page M.30 for busbar patterns.

◆NEMA hole sizes and spacing.

Table continues on page M.40



Flex Conductor, Two-Hole, Long Barrel with Window Lug (continued)

Part Number	Fig. No.	Flex Conductor Size		Code Conductor Size	Stud Hole Size In.	Stud Hole Spacing In.	Figure Dimensions In.			Panduit Crimping Tool‡	Panduit Die Color & Die No.‡	Wire Strip Length In.	Busbar Pattern^	Std. Pkg. Qty.
		Class G, H, I, K, M	Diesel Locomotive				W	B	L					
LCCX4-14A-L	1				1/4	0.63	0.55	1.05	2.49	CT-1700, CT-930, CT-2930/L, CT-2930/LE	Gray P29	1 1/8	B	50
LCCX4-38D-L	1	#4 AWG	#5, #4, #3 AWG	#4 AWG	3/8	1.00	0.62	1.05	3.09				B, D	50
LCCX2-14A-E	1				1/4	0.63	0.70	1.36	2.89	CT-1700, CT-930, CT-2930/L, CT-2930/LE	Brown P33	1 7/16	B	20
LCCX2-38D-E	1	#2 AWG	#2 AWG	#2 AWG	3/8	1.00	0.70	1.36	3.46				B, D	20
LCCX2-12-E	1				1/2	1.75	0.75	1.36	4.63				N	20
LCCX1/0-14A-X	1				1/4	0.63	0.85	1.50	3.23	CT-930, CT-2930/L, CT-2930/LE	Pink P42	1 9/16	B	10
LCCX1/0-38D-X	1	1/0 AWG	1/0 AWG	1/0 AWG	3/8	1.00	0.85	1.50	3.67				B, D	10
LCCX1/0-12-X	1				1/2	1.75	0.85	1.50	4.83				N	10
LCCX2/0-14A-X	1				1/4	0.63	0.96	1.50	3.27	CT-930, CT-2930/L, CT-2930/LE	Black P45	1 9/16	B	10
LCCX2/0-38D-X	1	2/0 AWG	2/0 AWG	2/0 AWG	3/8	1.00	0.96	1.50	3.70				B, D	10
LCCX2/0-12-X	1				1/2	1.75	0.96	1.50	4.87				N	10
LCCX3/0-38D-X	1	3/0 AWG	3/0 AWG	3/0 AWG	3/8	1.00	1.06	1.56	3.81	CT-930, CT-2930/L, CT-2930/LE	Orange P50	1 5/8	B, D	10
LCCX4/0-38D-X	1			4/0 AWG	3/8	1.00	1.19	2.24	4.55	CT-930, CT-2930/L, CT-2930/LE	Purple P54	2 5/16	B, D	10
LCCX4/0-12-X	1	4/0 AWG	4/0 AWG	4/0 AWG	1/2	1.75	1.19	2.24	5.73				N	10
LCCX250-38D-X	1	250 kcmil	262.6 kcmil	—	3/8	1.00	1.28	2.24	4.59	CT-930, CT-2930/L, CT-2930/LE	Yellow P62	2 5/16	B, D	10
LCCX350-12-6	1	350 kcmil	373.7 kcmil	—	1/2	1.75	1.54	2.50	6.13	CT-930, CT-2930/L, CT-2930/LE	Blue P76	2 9/16	N	6
LCCX350-38D-6	1	350 kcmil	373.7 kcmil	—	3/8	1.00	1.54	2.50	4.95	CT-930, CT-2930/L, CT-2930/LE	Blue P76	2 9/16	B, D	6
LCCX450-12-6	1	450 kcmil	444.4 kcmil	—	1/2	1.75	1.70	2.69	6.37	CT-930, CT-2930/L, CT-2930/LE	Brown P87	2 3/4	N	6
LCCX450-38D-6	1	450 kcmil	444.4 kcmil	—	3/8	1.00	1.70	2.69	5.19	CT-930, CT-2930/L, CT-2930/LE	Brown P87	2 3/4	B, D	6
LCCX500-12-6	1	500 kcmil	535.3 kcmil	—	1/2	1.75	1.89	2.88	6.66	CT-930, CT-2930/L, CT-2930/LE	Pink P99	2 15/16	N	6
LCCX500-38D-6	1	500 kcmil	535.3 kcmil	—	3/8	1.00	1.89	2.88	5.72	CT-930, CT-2930/L, CT-2930/LE	Pink P99	2 15/16	B, D	6
LCCX650-12-6	1	—	646.4 kcmil	—	1/2	1.75	1.95	2.94	6.75	CT-930, CT-2930/L, CT-2930/LE	Black P106	3.00	N	6

‡See pages M.54 and M.55 for Panduit and competitor tool and die information.
 **Consult cable manufacturer for voltage stress relief instructions with applications greater than 2000 V.
 ^See page M.30 for busbar patterns.
 ◆NEMA hole sizes and spacing.

UL US PATENTED CERTIFIED **Code/Flex Conductor HTAP**



- Used to tap into continuous conductors as a splice or pigtailling
- Each HTAP terminates a wide range of conductor sizes and combinations of code and flex conductors Class G, H, I and Locomotive to suit a variety of applications
- Slotted design allows quick and easy assembly of conductor to HTAP using three Panduit 94V-0 cable ties included
- Tap grooves are separated from one another allowing them to function independently so HTAP can be used with a single or multiple taps providing maximum design and installation flexibility
- Color coded and marked with Panduit die index numbers for proper crimp die selection
- Requires crimping tools and dies, see pages M.47 – M.49
- UL Listed and CSA Certified with AWG conductor for applications up to 600 V when crimped with Panduit and specified competitor crimping tools and Panduit crimping dies
- Tin plated to inhibit corrosion

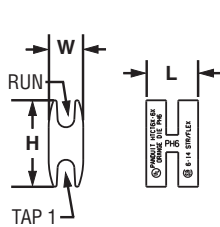
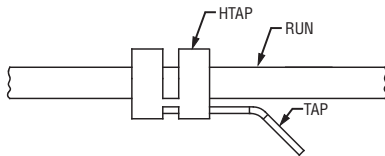

HTCT6X-6X

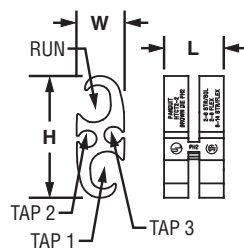

HTCT2-2

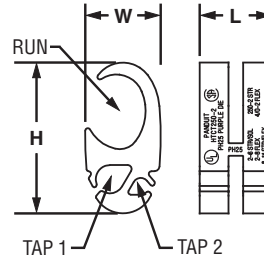

HTCT250-2

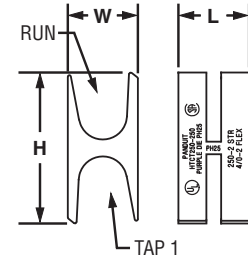

HTCT250-250

Part Number	Copper Conductor Size Range					Figure Dimensions In.			Panduit Crimping Tool‡	Panduit Die Color & Die No.‡	Wire Strip Length In.	Std. Pkg. Qty.
	Wire Strand Type	Run	Tap 1	Tap 2	Tap 3	L	W	H				
HTCT6X-6X-1	Code	#6 – #14 AWG	#6 – #14 AWG	—	—	0.60	0.40	1.00	CT-930, CT-2930/L, CT-2930/LE	Orange PH6	11/16	1
	Flex	#6 – #14 AWG	#6 – #14 AWG	—	—							
HTCT2-2-1	Code	#2 – #6 AWG STR/SOL	#2 – #6 AWG STR/SOL	#8 – #14 AWG	#8 – #14 AWG	0.76	0.61	1.55	CT-930, CT-2930/L, CT-2930/LE	Brown PH2	13/16	1
	Flex	#2 – #8 AWG	#2 – #8 AWG	#8 – #14 AWG	#8 – #14 AWG							
HTCT250-2-1	Code	250 kcmil – #2 AWG	#2 – #6 AWG STR/SOL	#8 – #14 AWG	—	0.92	0.96	1.92	CT-930, CT-2930/L, CT-2930/LE	Purple PH25	1	1
	Flex	4/0 – #2 AWG	#2 – #8 AWG	#8 – #14 AWG	—							
HTCT250-250-1	Code	250 kcmil – #2 AWG	250 kcmil – #2 AWG	—	—	0.90	0.89	1.92	CT-930, CT-2930/L, CT-2930/LE	Purple PH25	1	1
	Flex	4/0 – #2 AWG	4/0 – #2 AWG	—	—							

‡See page M.58 for Panduit and competitor tool and die information.



Clear Covers for HTCT HTAPs

- Made of high impact plastic to provide high impact strength and 360° inspections of crimped connection to assure the crimp is complete and the correct die was used
- Incorporate dual self-latching spring loaded latches and supplied with two Panduit UL 94V-0 cable ties to allow for easy snap-on assembly and ensure covers are secured
- Low profile design minimizes space requirements
- Each cover half supports installation information labels inside plastic retainer strips to allow labels to be viewed on either side of cover and to protect labels from being removed

- Incorporate molded in flash barriers which encompass the HTAP installation providing protection against electrical flash over
- UL 94V-0 flame rating and oxygen index of 28 providing self-extinguishing, flame retardant properties
- Part number, voltage rating, temperature rating and HTCT part number molded into cover for easy identification
- Flexible fingers located at each end of cover prevent foreign objects from entering cover and are made from ductile plastic material that allows easy installation and will not damage conductor insulation



Part Number	Use With HTAP Part Number	Figure Dimensions In.			Std. Pkg. Qty.
		L	W	H	
CLRCVR1-1	HTCT6X-6X-1	4.48	1.41	1.20	1
CLRCVR2-1	HTCT2-2-1	5.10	1.66	1.40	1
CLRCVR3-1	HTCT250-2-1, HTCT250-250-1	5.35	2.16	1.40	1

Labels for clear covers are sold separately and are printed with the Panduit® PanTher™ LS8E Hand-Held Thermal Transfer Printer, see pages O.1 – O.25.

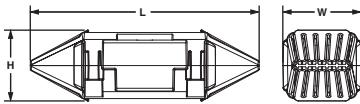

Shown Assembled



Code/Flex Conductor HTAP Kits



Part Number	Components		Std. Pkg. Qty.
	HTAP Part No.	Clear Cover Part No.	
HTWC6X-6X-1	HTCT6X-6X-1	CLRCVR1-1	1
HTWC2-2-1	HTCT2-2-1	CLRCVR2-1	1
HTWC250-2-1	HTCT250-2-1	CLRCVR3-1	1
HTWC250-250-1	HTCT250-250-1	CLRCVR3-1	1



Code Conductor, Thin Wall, Tin-Plated, CTAPF



- For copper-to-copper tapping splicing or pigtailing
- Wide wire range-taking capability minimizes inventory requirements
- Color-coded for proper crimp die selection
- Ribbed design provides high strength
- Made from high conductivity wrought copper
- Tin-plated to inhibit corrosion and oxidation
- UL Listed and CSA Certified with AWG conductor to 600 V and temperature rated to 90°C when crimped with Panduit and specified competitor crimping tools and dies

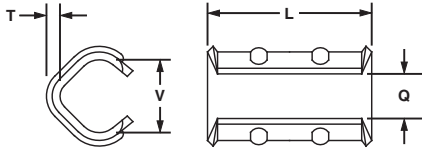

Part Number	Copper Conductor Size		Number of Ribs	Figure Dimensions In.				Panduit Crimping Tool‡	Panduit Color Code	Wire Strip Length In.	Std. Pkg. Qty.
	Run AWG	Tap AWG		L	T	V	Q				
CTAPF4-12TP-C	#6 AWG	#8 – #6 AWG	1	1.25	0.07	0.40	0.28	CT-1700, CT-930, CT-2930/L, CT-2930/LE	Brown	1 5/16	100
	#5, #4 AWG	#12 – #8 AWG									
CTAPF1/0-12TP-L	#2 AWG	#4 – #2 AWG	2	1.82	0.09	0.63	0.42	CT-930, CT-2930/L, CT-2930/LE	Orange	1 7/8	50
	#1 AWG	#4 – #3 AWG									
	1/0 AWG	#12 – #4 AWG									
CTAPF2/0-12TP-Q	#1 AWG	#2 – #1 AWG	2	1.82	0.09	0.71	0.48	CT-930, CT-2930/L, CT-2930/LE	Purple	1 7/8	25
	1/0 AWG	#3 – #2 AWG									
	2/0 AWG	#12 – #3 AWG									

‡See pages M.56 – M.57 for Panduit and competitor tool and die information.

UL **DB** **RATED** **Grounding Clamp, U-Bolt, Bronze**

- Used to ground copper conductor parallel or at a right angle to a rod, tube, or pipe
- Made from high strength, electrolytic cast bronze
- High strength silicon bronze hardware provides long term reliable assembly
- Accommodates a wide range of pipe, tube, rod and conductor sizes – minimizes inventory
- UL Listed for grounding and bonding with AWG conductor and suitable for direct burial in earth or concrete

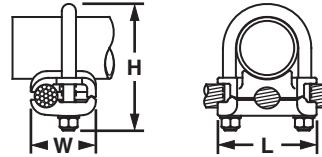

Part Number	Ground Rod Size In.	Iron Pipe Size In.	Conductor Size Range AWG	Figure Dimensions In.			Bolt Dia. In.	Hex Size In.	Std. Pkg. Qty.
				L	W	H			
GPL-8-Q	7/8 or 1	1/2 or 3/4	#8 SOL – #4 STR	2.38	1.38	2.63	3/8	9/16	25
GPL-14-X	—	1	#8 SOL – #4 STR	2.63	1.38	2.75	3/8	9/16	10
GPL-15-X	—	1	#4 SOL – 2/0 STR	2.63	1.63	2.75	3/8	9/16	10
GPL-16-X	—	1	2/0 SOL – 250 kcmil	2.63	1.88	3.25	3/8	9/16	10
GPL-22-X	—	1 1/4	2/0 SOL – 250 kcmil	3.00	1.88	3.50	3/8	9/16	10
GPL-28-X	—	1 1/2	2/0 SOL – 250 kcmil	3.25	1.88	4.00	3/8	9/16	10
GPL-34-3	—	2	2/0 SOL – 250 kcmil	3.75	1.88	4.25	3/8	9/16	3

UL **LISTED** **SF** **CERTIFIED** **Grounding Clamp for Water Pipes, Bronze**



- Used to ground copper code conductor to water pipe or copper tube
- Cast from high strength, electrolytic bronze to provide reliable grounding connections
- Plated steel screws provide high strength and inhibit corrosion
- Accommodates a wide range of pipe, tube, rod and conductor sizes – minimizes inventory
- UL Listed for grounding and bonding with AWG conductor and suitable for direct burial in earth or concrete

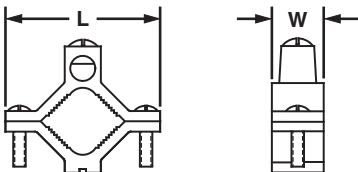

Part Number	Water Pipe Range In.	Conductor Size Range AWG	Figure Dimensions In.		Std. Pkg. Qty.
			L	W	
KP1-C	1/2 – 1	#10 SOL – #2 STR	2.28	0.66	100
KP2-L	1 1/4 – 2	#10 SOL – #2 STR	3.58	0.73	50



Grounding Clamp for Water Pipes, Aluminum

- Dual-rated for grounding aluminum or copper code conductors to copper water pipe, galvanized pipe, or steel conduit
- Made from high strength, extruded aluminum alloy to provide long term durability
- Tin-plated to inhibit corrosion and oxidation and for low contact resistance
- Plated steel screws provide high strength and inhibit corrosion
- Accommodates a wide range of pipe, tube, and conductor sizes – minimizes inventory requirements
- UL Listed and CSA Certified for grounding and bonding



Part Number	Water Pipe Range In.	Conductor Size Range AWG	Figure Dimensions In.		Std. Pkg. Qty.
			L	W	
GC-15A-Q	1/2 – 3/4 – 1	#14 AWG – 1/0 AWG	2.25	0.69	25
GC-18A-X	1 1/4 – 1 1/2 – 2	#6 AWG – 250 kcmil	3.75	0.81	10
GC-22A-4	2 1/2 – 3 – 3 1/2 – 4	#6 AWG – 250 kcmil	6.31	1.00	4

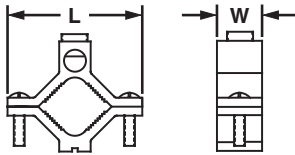

Split Bolt, Copper

- Made from high strength copper alloy to resist corrosion and provide premium electrical and mechanical performance
- Wire range-taking capability minimizes inventory requirements
- Nut hex provides correct fit with socket, box, or open end wrenches resulting in proper torquing of electrical connection
- Pressure bar provides secure connection on a full range of conductor combinations used with each connector assuring premium wire pull-out strength
- UL Listed and CSA Certified with AWG conductor for use up to 600 V and temperature rated 90°C
- SBCT3-C is tin-plated for bonding to galvanized wire baskets



SBC3-C



SBCT3-C
Tin-Plated

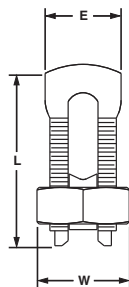

Part Number	Copper Conductor			Figure Dimensions In.			Std. Pkg. Qty.
	Range of Equal Run and Tap AWG		Min. Tap with One Max. Run AWG	E	W	L	
	Min.	Max.					

UL Listed and CSA Certified with Copper Code Conductors

SBC3-C	#8 STR	#4 STR	#14 STR	0.58	0.81	1.16	100
--------	--------	--------	---------	------	------	------	-----

UL Listed and CSA Certified with Copper and Aluminum Code Conductors

SBCT3-C*	#8 STR	#4 STR	#10 STR	0.58	0.81	1.24	100
----------	--------	--------	---------	------	------	------	-----

*The use of Panduit oxide inhibiting joint compound (CMP-100) is recommended. Refer to www.panduit.com for more information.

Hand Operated Plier Type Tools

- Installer controlled crimp
- Available with wire stripping and cutting features
- Plier type crimp for #22 thru 10 insulated and non-insulated terminal products

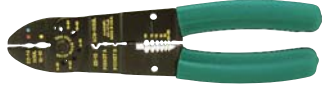

Part Number	Part Description	Std. Pkg. Qty.
CT-100A	Crimps most Panduit #22 – 10 AWG insulated and non-insulated terminals, disconnects, and splices. Crimps 4mm ² – 6mm ² copper metric lugs. Cuts #4, #6, #8 and #10 screw sizes. Cuts and strips wire. Excellent all-around application tool of heat treated finished steel with comfortable cushioned plastic grip handles.	1

Contour Crimp™ Controlled Cycle Tools

- Controlled cycle mechanism assures high quality, consistent terminations
- Ergonomic tool design assures operator comfort, safety, and performance
- Polypropylene, elastomeric handles provide chemical resistance and a cushioned, non-slip grip



CT-1550



CT-1570



CT-1700



CT-1701

Part Number	Part Description	Std. Pkg. Qty.
CT-1550	Crimps most Pan-Term [®] #22 – 10 AWG nylon and vinyl insulated terminals, splices, and disconnects. The CT-1550 has the red/blue pocket closest to the pivot which provides a reduced crimp effort for those who make red/blue terminations.	1
CT-1570	Crimps most Pan-Term [®] #22 – 10 AWG and .5 – 6.0mm ² non-insulated terminals and disconnects. Crimps Panduit #22 – 10 AWG and .5 – 6.0mm ² non-insulated splices, #14 – #10 AWG copper code conductor lugs, and 4mm ² – 6mm ² copper metric lugs.	1
CT-1700	Crimps Panduit #8 – 2 AWG non-insulated tubular terminals (S series), #8 – 1 AWG copper code conductor lugs and splices, #8 – 2 AWG copper flex conductor lugs, #6 – 4 AWG dual rated aluminum lugs and splices and CTAPF10-16 to CTAPF3-12 copper taps. Includes 5-position, color coded rotating die.	1
CT-1701	Crimps Panduit #10 – 2 AWG non-insulated large gauge ring terminals (P series), #12 – 4 AWG non-insulated heavy duty ring terminals (P series), #14 – 10 AWG copper code conductor lugs, and 4mm ² – 6mm ² copper metric lugs. Includes 5-position, rotating die.	1

Die Type, Manual Hydraulic, 14 Ton, Crimping Tool

- Two-stage rapid advance hydraulic system minimizes number of pumps required to complete a crimp – saves time
- Cushioned grip prevents hands from slipping on tool – reduces fatigue
- Provides UL Listed and CSA Certified connections on Panduit copper and aluminum lugs and splices and copper taps

- Open "C-Head" design allows easy loading of crimping dies and connectors, saves time
- Requires crimping dies, see page M.49
- Dies installed using spring loaded die retention pins, no need for tools
- Rubber boot on crimp head provides abrasion protection
- Audible "pop-off" valve indicates crimp completion
- Crimp head rotates 180°, provides versatility for use in restricted spaces



Part Number	Part Description	Std. Pkg. Qty.
CT-930	<p>Terminates Panduit Compression Connectors:</p> <ul style="list-style-type: none"> • Copper compression lugs and splices for #8 AWG – 750 kcmil code conductor • Copper compression lugs and splices for #8 AWG – 600 kcmil flex conductor • Copper compression lugs and splices for 10mm² – 400mm² Class 2r metric conductor • Copper compression lugs and splices for 10mm² – 300mm² Class 5f and 10mm² – 240mm² Class 6f metric conductor • StructuredGround™ Direct Burial Compression Grounding System Connectors for #6 AWG – 250 kcmil code conductor and select 500 kcmil conductor combinations • Copper compression CTAPF taps for #10 – 3/0 AWG code conductor • Copper compression CTAP taps for #8 – 4/0 AWG code conductor • Copper compression HTCT taps for #14 AWG – 250 kcmil code conductor, #14 – 4/0 AWG flex conductor • Aluminum compression lugs and splices for #6 AWG – 600 kcmil code conductor • Panduit® Pan-Term® Tubular Terminals for #8 AWG – 250 kcmil code conductor <p>Specifications: Output: 14 tons Jaw opening: 1.65" Weight: 16.5 lbs. Length: 25" Handle span: 17 1/2" (open), 6" (closed) Warranty: 5 years</p> <p>CT-930 includes: • Tool • Plastic tool case with die storage</p>	1

Compatible with CD-920 and CD-930 crimping dies, sold separately, see page M.49.

Die Type, Lithium-Ion Powered Hydraulic, 14 Ton, Crimping Tool

- Lithium-Ion battery powered, provides fingertip operation and up to 71.5% more crimps per battery charge than tools powered with NiCd or NiMH batteries
- Pistol grip tool design with open "C-Head" provides easy loading of crimping dies and rotates 180°, for reaching into tight spaces
- Provides UL Listed and CSA Certified connections on Panduit copper and aluminum lugs and splices and copper taps
- Tool provided with two, Milwaukee® M18™ XC high capacity RED lithium-ion 18VDC rechargeable batteries, battery charger and shoulder strap
- Batteries incorporate LED fuel gage so battery charge level can be checked to allow for continuous operation
- Approximately 9.6 second crimp cycle time provides quick terminations, 30% faster than tools using NiCd or NiMH batteries
- Battery charger charges expended batteries completely in 60 minutes
- Requires crimping dies, see page M.49
- Dies installed using spring loaded die retention pins, no need for tools
- Tool provided with heavy-duty, soft sided tool bag with 58 pockets for storing tool, batteries, charger, dies, etc.



CT-2930/L and CT-2930/LE



FREE! Heavy-Duty Soft Sided Tool Bag Included

Part Number	Charger Voltage	Part Description	Std. Pkg. Qty.
CT-2930/L	120 VAC	Terminates Panduit compression connectors: <ul style="list-style-type: none"> • Copper compression lugs and splices for #8 AWG – 750 kcmil code conductor • Copper compression lugs for #8 AWG – 600 kcmil flex conductor • Copper compression S Series, Pan-Term™ Tubular Terminals for #8 AWG – 250 kcmil code conductor • Copper compression lugs and splices for 10mm² – 400mm² Class 2r conductor • Copper compression lugs and splices for 10mm² – 300mm² Class 5f conductor and 10mm² – 240mm² Class 6f conductor • StructuredGround™ Direct Burial Compression Grounding System connectors #6 AWG – 250 kcmil code conductor and select 500 kcmil conductor combinations • Copper compression CTAPF taps for #10 – 3/0 AWG code conductor • Copper compression CTAP taps for #8 – 4/0 AWG code conductor • Copper compression HTCT taps for #14 AWG – 250 kcmil code conductor, #14-4/0 AWG flex conductor • Aluminum compression lugs and splices for #6 AWG – 600 kcmil code conductor 	1
CT-2930/LE	230 VAC	Specifications: Output: 14 tons (124.5 Kn) Jaw opening: 1.65" (41.9mm) Weight: 17.90 lbs. (8.1 kg) with battery Length: 14.5" (368.3mm), Height: 16.5" (419.1mm), Width: 3.25" (82.6mm) Warranty: 5 years on tool, batteries and charger Tool includes: <ul style="list-style-type: none"> • Two Milwaukee® M18™ XC high capacity RED lithium-ion 18VDC rechargeable batteries • One Milwaukee® battery charger • One shoulder strap • Heavy-duty bag with storage for tool, batteries, charger, and crimping dies; includes 58 pockets and a shoulder strap for added convenience; 18"L x 7"W x 14"H* 	1

Compatible with CD-920, CDM-920, and CD-930 crimping dies, sold separately, see page M.49. Tool bag also sold separately, see part number PTB-GP on www.panduit.com.

CD-920 Crimping Dies

- Crimping dies and connectors are color-coded for easy matching
- Emboss die index number on connector barrels for post crimp inspection
- Part number permanently marked on crimping die for easy identification

- Provide circumferential crimp results in terminations with premium electrical and mechanical performance
- Used in Panduit crimping tools; see the CT-930 crimping tool on page M.47 and the CT-2930/L and CT-2930/LE crimping tools on page M.48

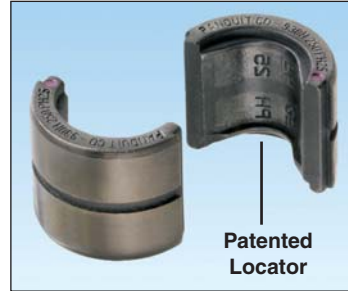
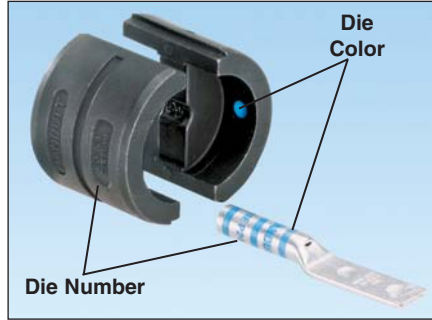

HTAP Die with Patented Locator



CD-920



CD-930H



CDM-920

Part Number	Used to Install Panduit Compression Lug and Splice Sizes	Std. Pkg. Qty.
	Copper Code Conductor Size and Die Color and Die No.	

Single Crimp Dies

CD-920-8	#8 AWG, Red P21	1
CD-920-6	#6 AWG, Blue P24	1
CD-920-4	#4 AWG, Gray P29	1
CD-920-2	#2 AWG, Brown P33	1
CD-920-1	#1 AWG, Green P37	1
CD-920-1/0	1/0 AWG, Pink P42	1
CD-920-2/0	2/0 AWG, Black P45	1
CD-920-3/0	3/0 AWG, Orange P50	1
CD-920-4/0	4/0 AWG, Purple P54	1
CD-920-250	250 kcmil, Yellow P62	1
CD-920-350	350 kcmil, Red P71	1
CD-920-400	400 kcmil, Blue P76	1
CD-920-500	500 kcmil, Brown P87	1
CD-920-500A	500 kcmil, Pink P99	1
CD-920-600	600 kcmil, Green P94	1
CD-920-750	750 kcmil, Black P106	1

Part Number	Used to Install Panduit HTAP Part Numbers	Std. Pkg. Qty.
	Copper HTAP and Die Color and Die No.	

Single Crimp Dies with Patented Locator

CD-920H-6	HTCT6X-6X-1, Orange PH6	1
CD-920H-2	HTCT2-2-1, Brown PH2	1
CD-930H-250	HTCT250-2-1, HTCT250-250-1, Purple PH25	1

Part Number	Used to Install Panduit CTAPF Part Numbers	Std. Pkg. Qty.
	Copper CTAPF and Die Color and Die No.	

Multi-Crimp Dies

CDM-920-2	CTAPF4, Brown P33M	1
CDM-920-3/0	CTAPF1/0, Orange P50M	1
CDM-920-4/0	CTAPF2/0, Purple P54M	1

For use with Copper Conductors

Installation Tooling and Die Selections for Type LCC-W

How to read this chart

For LCC6-W lug and CT-2001 crimping tool:

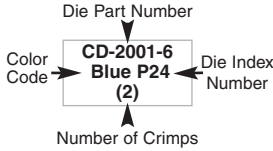

Panduit Part Number	Std. Wire Size	Wire Strip Length (In.)	Panduit						Thomas & Betts				
			CT-1570	CT-1701 ^①	CT-1700 ^①	CT-720	CT-2920, CT-940CH ^③	Uni-Die™ Dieless CT-980, CT-980CH, CT-2930, CT-2930/L, CT-2930/LE, CT-2931, CT-920 CT-920CH, CT-2940 ^③ , CT-2940/L ^③ , CT-2940/LE ^③	CT-2001, CT-2001/L, CT2001/LE, CT-2002, CT-2002/L, CT-3001, CT-3001/E	TBM20S, TBM25S	TBM5	TBM6, TBM6S, 25000, TBM8	TBM12, 13642M
Die Part Number/Color Code and Die Index Number/(Number of Crimps)													
LCC10-W	#14 – #10 AWG STR, #12 – #10 AWG SOL	9/16	12-10 (2)	P10 (2)	—	—	—	—	—	—	—	—	—
LCC8-W	#8 AWG	3/4	—	—	Red P21 (3)	CD-720-1 Red P21 (2)	CD-920-8 Red P21 (1)	—	CD-2001-8 Red P21 (2)	Red 21 (3)	Red 21 (1)	Red 21 (1)	Red 21 (1)
LCC6-W	#6 AWG	1-1/8	—	—	Blue P24 (3)	CD-720-1 Blue P24 (2)	CD-920-6 Blue P24 (1)	—	CD-2001-6 Blue P24 (2)	Blue 24 (3)	Blue 24 (1)	Blue 24 (1)	Blue 24 (1)
LCC4-W	#4 – #3 AWG STR, #2 AWG SOL	1-1/8	—	—	Gray P29 (3)	CD-720-1 Gray P29 (2)	CD-920-4 Gray P29 (1)	#4 – #2 AWG #2 AWG SOL Only (1)	CD-2001-4 Gray P29 (2)	Gray 29 (3)	Gray 29 (1)	Gray 29 (1)	Gray 29 (1)
LCC2-W	#2 AWG	1-1/4	—	—	Brown P33 (3)	CD-720-1 Brown P33 (2)	CD-920-2 Brown P33 (1)	#6 – #2 AWG (1)	CD-2001-2 Brown P33 (2)	Brown 33 (3)	Brown 33 (1)	Brown 33 (1)	Brown 33 (1)
LCC1/0-W	1/0 AWG	1-1/2	—	—	—	CD-720-2 Pink P42 (2)	CD-920-1/0 Pink P42 (2)	#6 – 1/0 AWG (2)	CD-2001-1/0 Pink P42 (2)	—	Pink 42 (2)	Pink 42 (2)	Pink 42 (2)
LCC2/0-W	2/0 AWG	1-9/16	—	—	—	CD-720-2 Black P45 (3)	CD-920-2/0 Black P45 (3)	#4 – 2/0 AWG (2)	CD-2001-2/0 Black P45 (3)	—	Black 45 (3)	Black 45 (3)	Black 45 (2)
LCC3/0-W	3/0 AWG	1-9/16	—	—	—	CD-720-2 Orange P50 (3)	CD-920-3/0 Orange P50 (3)	#2 – 3/0 AWG (2)	CD-2001-3/0 Orange P50 (3)	—	Orange 50 (3)	Orange 50 (3)	Orange 50 (2)
LCC4/0-W	4/0 AWG	1-5/8	—	—	—	CD-720-3 Purple P54 (3)	CD-920-4/0 Purple P54 (3)	#1 – 4/0 AWG (2)	CD-2001-4/0 Purple P54 (3)	—	Purple 54 (3)	Purple 54 (3)	Purple 54 (2)
LCC250-W	250 kcmil	1-11/16	—	—	—	CD-720-3 Yellow P62 (4)	CD-920-250 Yellow P62 (3)	1/0 AWG – 250 kcmil (3)	CD-2001-250 Yellow P62 (3)	—	Yellow 62 (4)	Yellow 62 (4)	Yellow 62 (2)

① The CT-1700 and CT-1701 crimp die pockets are integrated into the tool frame.
 ② Half width dies.
 ③ CD-920 dies can be used with CT-940CH and CT-2940 tools with CD-940-DA adapter.
 ④ Maximum size: 500 kcmil lugs.

⑤ Maximum size: 250 kcmil lugs.
 ⑥ Requires U die adapter.
 ⑦ Minimum size: #4 AWG lugs.
 ⑧ Extended wire range when crimped with these Panduit® Uni-Die™ Dieless Crimping Tools.

Installation Tooling and Die Selections for Type LCC-W (continued)

Thomas & Betts			Burdny					Anderson	Penn-Union	Greenlee
TBM15, TBM15I, TBM15BSCR	TBM8-750M-1, TBM8-750, TBM750BSCR ^② , TBM8-750BSCR	TBM14M, TBM14BSCR, BPLT14BSCR, 13100A	Y2MR, Y1MR, Y1MRTC	MY29	Y35, Y35BH, Y39, Y39BH, Y750, Y750-2, Y750BH, Y750HS, Y750BH-2, PAT750, BAT750, BAT35	Y45 ^⑤ , Y46 ^⑤	Y644M, Y644HS, Y644MBH, PAT644, BAT644	VC6	TDY-1	1989
Die Part Number/Color Code and Die Index Number/(Number of Crimps)										
—	—	—	—	—	—	—	—	—	—	—
Red 21 (1)	STD (1)	Red 21 (1)	Red 49 (2)	#8 (1)	U8CRT Red 49 (1)	U8CRT Red 49 (1)	—	—	—	—
Blue 24 (1)	STD (1)	Blue 24 (1)	Blue 7 (2)	#6 (1)	U5CRT Blue 7 (1)	U5CRT Blue 7 (1)	STD (1)	STD (1)	—	—
Gray 29 (1)	STD (1)	Gray 29 (1)	Gray 8 (2)	#4 (1)	U4CRT Gray 8 (1)	U4CRT Gray 8 (1)	STD (1)	STD (1)	—	STD (1)
Brown 33 (1)	STD (1)	Brown 33 (1)	Brown 10 (2)	#2 (1)	U2CRT Brown 9 (solid) / Brown 10 (stranded) (2)	U2CRT Brown 9 (solid) / Brown 10 (stranded) (2)	STD (1)	STD (1)	STD (1)	STD (1)
Pink 42H ^② (4)	STD (2)	Pink 42H ^② (4)	—	1/0 (2)	U25RT Pink 12 (2)	U25RT Pink 12 (2)	STD (1)	STD (1)	STD (1)	STD (1)
Black 45 (2)	STD (2)	Black 45 (2)	—	2/0 (2)	U26RT Black 13 (2)	U26RT Black 13 (2)	STD (1)	STD (1)	STD (1)	STD (1)
Orange 50 (2)	STD (2)	Orange 50 (2)	—	3/0 (2)	U27RT Orange 14 (2)	U27RT Orange 14 (2)	STD (1)	STD (2)	STD (1)	STD (1)
Purple 54H ^② (4)	STD (2)	Purple 54H ^② (4)	—	4/0 (2)	U28RT Purple 15 (2)	U28RT Purple 15 (2)	STD (1)	STD (2)	STD (1)	STD (1)
Yellow 62 (2)	STD (2)	Yellow 62 (2)	—	250 (2)	U29RT Yellow 16 (2)	U29RT Yellow 16 (2)	STD (1)	STD (2)	STD (1)	STD (1)

① The CT-1700 and CT-1701 crimp die pockets are integrated into the tool frame.

② Half width dies.

③ CD-920 dies can be used with CT-940CH and CT-2940 tools with CD-940-DA adapter.

④ Maximum size: 500 kcmil lugs.

⑤ Maximum size: 250 kcmil lugs.

⑥ Requires U die adapter.

⑦ Minimum size: #4 AWG lugs.

⑧ Extended wire range when crimped with these Panduit® Uni-Die™ Dieless Crimping Tools.

For use with Copper Conductors

Installation Tooling and Die Selections for Type LCC-W (continued)

Panduit Part Number	Std. Wire Size	Wire Strip Length (In.)	Panduit							Thomas & Betts			
			CT-1570	CT-1701 ^①	CT-1700 ^①	CT-720	CT-930, CT-930CH, CT-930LPCH ^⑤ , CT-2930, CT-2930/L, CT-2930/LE, CT-2931, CT-920, CT-920CH, CT-2940 ^③ , CT-2940/L ^③ , CT-2940/LE ^③ , CT-2920, CT-940CH ^③	Uni-Die™ Dieless CT-980, CT-980CH, CT-2950 ^④ , CT-2980, CT-2980/L, CT-2980/LE, CT-2981, CT-980LPCH ^⑤ Extended Wire Range ^⑥	CT-2001, CT-2001/L, CT-2001/LE, CT-2002, CT-2002/L, CT-3001, CT-3001/E	TBM20S, TBM25S	TBM5	TBM6, TBM6S, 25000 TBM8	TBM12, 13642M
Die Part Number/Color Code and Die Index Number/(Number of Crimps)													
LCC350-W	350 kcmil	2-5/16	—	—	—	CD-720-5 Red P71 (4)	CD-920-350 Red P71 (3)	3/0 AWG – 350 kcmil (3)	CD-2001-350 Red P71 (3)	—	—	Red 71 (4)	Red 71H ^② (4)
LCC400-W	400 kcmil	2-3/8	—	—	—	CD-720-6 Blue P76 (4)	CD-920-400 Blue P76 (3)	4/0 AWG – 400 kcmil (3)	CD-2001-400 Blue P76 (4)	—	—	Blue 76 (4)	Blue 76H ^② (4)
LCC500-W	500 kcmil	2-9/16	—	—	—	CD-720-7 Brown P87 (4)	CD-920-500 Brown P87 (3)	4/0 AWG – 500 kcmil (3)	CD-2001-500 Brown P87 (4)	—	—	Brown 87 (4)	Brown 87H ^② (4)
LCC600-W	600 kcmil	2-3/4	—	—	—	—	CD-920-600 Green P94 (4)	250 – 600 kcmil (3)	—	—	—	—	Green 94H ^② (4)
LCC750-W	750 kcmil	2-15/16	—	—	—	—	CD-920-750 CD-940-750 ^④ Black P106 (4)	500 – 750 kcmil (3)	—	—	—	—	Black 106H ^② (4)

① The CT-1700 and CT-1701 crimp die pockets are integrated into the tool frame.
 ② Half width dies.
 ③ CD-920 dies can be used with CT-940CH and CT-2940 tools with CD-940-DA adapter.
 ④ Maximum size: 500 kcmil lugs.

⑤ Maximum size: 250 kcmil lugs.
 ⑥ Requires U die adapter.
 ⑦ Minimum size: #4 AWG lugs.
 ⑧ Extended wire range when crimped with these Panduit® Uni-Die™ Dieless Crimping Tools.

Installation Tooling and Die Selections for Type LCC-W (continued)

Thomas & Betts			Burndy					Anderson	Penn-Union	Greenlee
TBM15, TBM15I, TBM15BSCR	TBM8-750M-1, TBM8-750, TBM750BSCR ^⑦ , TBM8-750BSCR	TBM14M, TBM14BSCR, BPLT14BSCR, 13100A	Y2MR, Y1MR, Y1MRTC	MY29	Y35, Y35BH, Y39, Y39BH, Y750, Y750-2, Y750BH, Y750HS, Y750BH-2, PAT750, BAT750, BAT35	Y45 ^⑥ , Y46 ^⑥	Y644M, Y644HS, Y644MBH, PAT644, BAT644	VC6	TDY-1	1989
Die Part Number/Color Code and Die Index Number/(Number of Crimps)										
Red 71 ^② (4)	STD (3)	Red 71 (4)	—	—	U31RT Red 18 (3)	U31RT Red 18 (3)	STD (1)	STD (3)	STD (2)	STD (1)
Blue 76 ^② (4)	STD (3)	Blue 76 (4)	—	—	U32RT Blue 19 (3)	U32RT Blue 19 (3)	STD (1)	STD (3)	STD (2)	STD (1)
Brown 87 ^② (4)	STD (3)	Brown 87 (4)	—	—	U34RT Brown 20 (3)	U34RT Brown 20 (3)	STD (1)	STD (3)	STD (2)	STD (1)
Green 94 ^② (4)	STD (4)	Green 94 (4)	—	—	U36RT Green 22 (4)	U36RT Green 22 (4)	STD (1)	—	STD (4)	—
Black 106 ^② (4)	STD (4)	Black 106 (4)	—	—	U39RT Black 24 (5)	U39RT Black 24 (5)	STD (1)	—	STD (2)	—

- ① The CT-1700 and CT-1701 crimp die pockets are integrated into the tool frame.
- ② Half width dies.
- ③ CD-920 dies can be used with CT-940CH and CT-2940 tools with CD-940-DA adapter.
- ④ Maximum size: 500 kcmil lugs.

- ⑤ Maximum size: 250 kcmil lugs.
- ⑥ Requires U die adapter.
- ⑦ Minimum size: #4 AWG lugs.
- ⑧ Extended wire range when crimped with these Panduit® Uni-Die™ Dieless Crimping Tools.

For use with Copper Conductors

Installation Tooling and Die Selections for Type LCCX

How to read this chart

For LCCX6 lug and CT-2001 crimping tool:

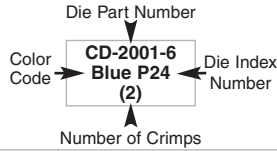

Panduit Part Number	Std. Wire Size	Cable Classes	Wire Strip Length (In.)	Panduit		
				CT-1700 ^①	CT-2001, CT-2001/L, CT-2001/LE, CT-2002, CT2002/L, CT-3001, CT3001/E	CT-930, CT-930/CH, CT-2930, CT-2930/L, CT-2930/LE, CT-2931, CT-920, CT-920CH, CT-2940 ^② , CT-2940/L ^② , CT-2940/LE ^② , CT-2920, CT-940CH ^②
Die Part Number/Color Code and Die Index Number/(Number of Crimps)						
LCCX8	#8 AWG	Compact B, G, H, I, K, M, Locomotive (DLO)	3/4	Red P21 (3)	CD-2001-8 Red P21 (2)	CD-920-8 Red P21 (1)
LCCX6	#6 AWG	Compact, B, G, H, I, K, M, Locomotive (DLO)	1-1/8	Blue P24 (3)	CD-2001-6 Blue P24 (2)	CD-920-6 Blue P24 (1)
LCCX4	#4 AWG	Compact, B, G, H, I, K, M	1-1/8	Gray P29 (3)	CD-2001-4 Gray P29 (2)	CD-920-4 Gray P29 (1)
	#5, #4, #3 AWG	Locomotive (DLO)				
LCCX2	#2 AWG	Compact, B, G, H, I, M, Locomotive (DLO) ^{④⑤}	1-7/16	Brown P33 (3)	CD-2001-2 Brown P33 (2)	CD-920-2 Brown P33 (1)
LCCX1/0	1/0 AWG	Compact, B, G, H, I, K, M, Locomotive (DLO)	1-9/16	—	CD-2001-1/0 Pink P42 (3)	CD-920-1/0 Pink P42 (3)
LCCX2/0	2/0 AWG	Compact, B, G, H, I, K, M, Locomotive (DLO) ^⑥	1-9/16	—	CD-2001-2/0 Black P45 (3)	CD-920-2/0 Black P45 (3)
LCCX3/0	3/0 AWG	Compact, B, G, H, I, K, M, Locomotive (DLO) ^⑥	1-5/8	—	CD-2001-3/0 Orange P50 (3)	CD-920-3/0 Orange P50 (3)
LCCX4/0	4/0 AWG	Compact, B, G, H, I, K, M, Locomotive (DLO)	2-5/16	—	CD-2001-4/0 Purple P54 (3)	CD-920-4/0 Purple P54 (3)
LCCX250	250 kcmil	G, H, I, K, M	2-5/16	—	CD-2001-250 Yellow P62 (3)	CD-920-250 Yellow P62 (3)
	262.6 kcmil	Locomotive (DLO)				
LCCX350	350 kcmil	G, H, I, K, M	2-9/16	—	CD-2001-400 Blue P76 (4)	CD-920-400 Blue P76 (3)
	373.7 kcmil	Locomotive (DLO)				
LCCX450	450 kcmil	G, H, I, K, M	2-3/4	—	—	CD-920-500 Brown P87 (4)
	444.4 kcmil	Locomotive (DLO)				
LCCX500	535.3 kcmil	Locomotive (DLO)	2-15/16	—	—	CD-920-500A Pink P99 (4)
LCCX650	646.4 kcmil	Locomotive (DLO)	1-1/2	—	—	CD-940-750 ^⑦ Black P106 (2)

①The CT-1700 crimp die pockets are integrated into the tool frame.
 ②CD-920 dies can be used with CT-940CH and CT-2940 tools with CD-940-DA adapter.
 ③Requires U die adapter.
 ④Does not include class K Flex Conductor with Burndy tools.

⑤Does not include class M Flex Conductor with T&B tools.
 ⑥Does not include class K Flex Conductor with T&B tools.
 ⑦Half width dies.
 ⑧CD-940 dies to be used exclusively with CT-940CH and CT-2940 tools.

Installation Tooling and Die Selections for Type LCCX (continued)

Thomas & Betts						Burndy			
TBM12	TBM8	TBM6, 25000	TBM6BSCR, TBM6H	TBM8-750, TBM8-750M-1	TBM14BSCR, TBM14M, TBM15	BCT500HS, Y500CTHS	Y644M	Y35, Y39, Y750, Y46 ^③ , Y750-2, Y750BH, BAT35-14V, BAT750-14V, PAT750-18V	MRC840
Die Part Number/Color Code and Die Index Number/(Number of Crimps)									
TBM12D-1 Red 21 (2)	13461 Red 21 (2)	13475 and 13477 Red 21 (2)	6TON21 Red 21 (2)	STD (2)	15520 Red 21 (2)	W8CRT Red 49 (2)	—	U8CRT Red 49 (2)	Red 49 (2)
TBM12D-1 Blue 24 (2)	13461 Blue 24 (2)	13475 and 13477 Blue 24 (2)	6TON24 Blue 24 (2)	STD (2)	15522 Blue 24 (2)	W5CRT Blue 7 (2)	(2)	U5CRT Blue 7 (2)	Blue 7 (2)
TBM12D-2 Gray 29 (3)	13461 Gray 29 (2)	13472 and 13476 Gray 29 (3)	6TON29 Gray 29 (2)	STD (3)	15527-CK Gray 29 (2)	W4CRT Gray 8 (2)	(2)	U4CRT Gray 8 (2)	—
TBM12D-2 Brown 33 (3)	13461 Brown 33 (3)	13474 and 13477 Brown 33 (3)	6TON33 Brown 33 (2)	STD (3)	15528 Brown 33 (2)	W2CRT Brown 10 (2)	(2)	U2CRT Brown 10 (2)	—
TBM12D-3 Pink 42 (3)	13462 Pink 42 (3)	13475 and 13477 Pink 42 (3)	6TON42 Pink 42 (3)	STD (3)	15508 Pink 42 (3)	W25RT Pink 12 (3)	(2)	U25RT Pink 12 (2)	—
TBM12D-4 Blk/Gold 45 (3)	13462 Black 45 (4)	13474 and 13477 Black 45 (3)	6TON45 Black 45 (3)	STD (3)	15526 Black 45 (2)	W26RT Black 13 (3)	(2)	U26RT Black 13 (2)	—
TBM12D-4 Org/Tan 50 (3)	13462 Orange 50 (4)	13474 and 13477 Orange 50 (3)	6TON50 Orange 50 (3)	STD (3)	15530 Orange 50 (3)	W27RT Orange 14 (4)	(2)	U27RT Orange 14 (2)	—
TBM12D-5 Purp/Olive 54 (4)	—	—	6TON54 Purple 54 (4)	STD (4)	15511 Purple 54 (4)	W28RT Purple 15 (4)	(3)	U28RT Purple 15 (3)	—
TBM12D-5 Yellow 62 (3)	—	—	6TON62 Yellow 62 (4)	STD (4)	15510-CK Yellow 62 (2)	W29RT Yellow 16 (4)	(3)	U29RT Yellow 16 (3)	—
TBM12D-4 Blue 76H ^⑦ (4)	—	—	6TON76 Blue 76H ^⑦ (4)	STD (4)	15512 Blue 76H ^⑦ (4)	W32RT Blue 19 (4)	(3)	U32RT Blue 19 (4)	—
TBM12D-3 Brown 87H ^⑦ (4)	—	—	6TON87 Brown 87H ^⑦ (4)	STD (4)	15506 Brown 87H ^⑦ (4)	—	(4)	U34RT Brown 20 (4)	—
TBM12D-2 Pink 99H ^⑦ (4)	—	—	—	STD (4)	15505 Pink 99H ^⑦ (4)	—	(4)	U38XRT Pink L99 (4)	—
TBM12D-2 Black 106H ^⑦ (2)	—	—	—	—	15515-CK Black 106H ^⑦ (2)	—	(1)	U39RT Black 24 (2)	—

①The CT-1700 crimp die pockets are integrated into the tool frame.
 ②CD-920 dies can be used with CT-940CH and CT-2940 tools with CD-940-DA adapter.
 ③Requires U die adapter.
 ④Does not include class K Flex Conductor with Burndy tools.

⑤Does not include class M Flex Conductor with T&B tools.
 ⑥Does not include class K Flex Conductor with T&B tools.
 ⑦Half width dies.
 ⑧CD-940 dies to be used exclusively with CT-940CH and CT-2940 tools.

For use with Copper Conductors

Installation Tooling and Die Selections for Type CTAPF

How to read this chart

For CTAPF6-12 tap and CT-2001 crimping tool:

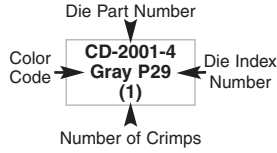

Panduit Part Number	Stranded Wire Size		Panduit			
	Main	Tap	CT-1700 ^①	CT-930, CT-930CH, CT-2930, CT-2930/L, CT-2930/LE, CT-2931, CT-920, CT-920CH, CT-2940 ^② , CT-2940/L ^② , CT-2940/LE ^② , CT-2920, CT-940CH ^②	CT-2001, CT-2001/L, CT-2001/LE, CT-2002, CT-2002/L, CT-3001, CT-3001/E	
	Die Part Number/Color Code and Die Index Number/ (Number of Crimps)					
CTAPF4-12	#6 AWG	#8 – #6 AWG	Brown P33 (4)	CDM-920-2 Brown P33M (1)	CDM-2001-2 Brown P33M (1)	CD-2001-2 Brown P33 (2)
	#5, #4 AWG	#12 – #8 AWG				
CTAPF1/0-12	#2 AWG	#4 – #2 AWG	—	CDM-920-3/0 Orange P50M (1)	CDM-2001-3/0 Orange P50M (2)	CD-2001-3/0 Orange P50 (3)
	#1 AWG	#4 – #3 AWG				
	1/0 AWG	#12 – #4 AWG				
CTAPF2/0-12	#1 AWG	#2 – #1 AWG	—	CDM-920-4/0 Purple P54M (1)	—	CD-2001-4/0 Purple P54 (3)
	1/0 AWG	#3 – #2 AWG				
	2/0 AWG	#12 – #3 AWG				

①The CT-1700 crimp die pockets are integrated into the tool frame.

②CD-920 dies can be used with CT-940CH and CT-2940 tools with CD-940-DA adapter.

Installation Tooling and Die Selections for Type CTAPF (continued)

Panduit Part Number	Stranded Wire Size		Burndy		Thomas & Betts
			Y35, Y39, Y45, Y46, Y750BH-2, Y750, BAT35, BAT750, Y35BH, Y39BH, Y750BH, Y750HS, PAT750, Y750-2	Y500CT-HS, BCT500-HS, BCT500, Y500CT	TBM8-750, TBM8-750M-1, TBM8-750BSCR
	Main	Tap	Die Part Number/Color Code and Die Index Number/ (Number of Crimps)		
CTAPF4-12	#6 AWG	#8 – #6 AWG	UC4 Brown 10M (1)	WC4 Brown 10M (1)	TBM8-750C20 (1)
	#5, #4 AWG	#12 – #8 AWG			
CTAPF1/0-12	#2 AWG	#4 – #2 AWG	UC25 Orange 14M (1)	WC25 Orange 14M (2)	TBM8-750C3540 (1)
	#1 AWG	#4 – #3 AWG			
	1/0 AWG	#12 – #4 AWG			
CTAPF2/0-12	#1 AWG	#2 – #1 AWG	—	—	TBM8-750C4550 (1)
	1/0 AWG	#3 – #2 AWG			
	2/0 AWG	#12 – #3 AWG			

①The CT-1700 crimp die pockets are integrated into the tool frame.
 ②CD-920 dies can be used with CT-940CH and CT-2940 tools with CD-940-DA adapter.

For use with Copper Conductors

Installation Tooling and Die Selections for Type HTCT

How to read this chart

For HTCT6X-6X-1 tap and CT-2930/L crimping tool:

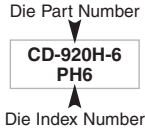

Installation Tools		
15 TON	14 TON	12 TON
Panduit		
CT-940CH ^① , CT-2940 ^① , CT-2940/L, CT-2940/LE	CT-930, CT-930CH, CT-2930, CT-2930/L, CT-2930/LE	CT-920, CT-920CH, CT-2920, CT-2931, CT-2931/E
Burndy		
Y46 ^① , Y46C ^①	—	Y35, Y35-2, Y35BH, Y35BH-4, Y750, Y39, Y39BH, Y750-2, Y750BH, Y750BH-2, Y750HS, BAT35, BAT750, PAT750C, PAT750, PAT750C
Thomas & Betts		
TBM15I, TBM15BSCR	TBM14M, TBM14BSCR, BPLT14BSCR, 13100A	—
Panduit Crimp Die Part Number/Die Index No. (Number of Crimps = 1)		
CD-920H-6 PH6	CD-920H-6 PH6	CD-920H-6 PH6
CD-920H-2 PH2	CD-920H-2 PH2	CD-920H-2 PH2
CD-930H-250 PH25	CD-930H-250 PH25	CD-930H-250 PH25
CD-930H-250 PH25	CD-930H-250 PH25	CD-930H-250 PH25

Panduit Part Number	Copper Conductor Sizes (Code Cable)				Copper Conductor Sizes (Flex Cable) Types G, H, I, K, M and Locomotive (DLO)				Crimp Die Color Code
	Main	Tap 1	Tap 2	Tap 3	Main	Tap 1	Tap 2	Tap 3	
HTCT6X-6X-1	#6-#14 AWG	#6-#14 AWG	—	—	#6-#14 AWG	#6-#14 AWG	—	—	Orange
HTCT2-2-1	#2-#6 AWG STR/SOL	#2-#6 AWG STR/SOL	#8-#14 AWG	#8-#14 AWG	#2-#8 AWG	#2-#8 AWG	#8-#14 AWG	#8-#14 AWG	Brown
HTCT250-2-1	250 kcmil -#2 AWG	#2-#6 AWG STR/SOL	#8-#14 AWG	—	4/0-#2 AWG	#2-#8 AWG	#8-#14 AWG	—	Purple
HTCT250-250-1	250 kcmil -#2 AWG	250 kcmil -#2 AWG	—	—	4/0-#2 AWG	4/0-#2 AWG	—	—	Purple

①CD-920H and CD-930H dies can be used with CT-940CH and CT-2940 Panduit tools and Y46 and Y46C Burndy tools with CD-940-DA adapter. Panduit crimping dies must be used with all tooling (Panduit and competitor) to maintain UL/CSA certifications for applications up to 600 V.

INDUSTRIAL

The Panduit® IndustrialNet™ Solution is a reliable, high performance network cabling infrastructure designed to support industrial networking applications in harsh factory environments. IP (Ingress Protection) and NEMA (National Electrical Manufacturers Association) rated products, including “hardened” network connectivity, withstand the harsh conditions encountered in industrial automation and industrial Ethernet applications.



- Connectors rated for factory and harsh environments – NEMA 6, 6P and IP67/IP65
- Fully integrated solution with proven interoperability from the enterprise to the industrial network
- Reduced cost of ownership for design, installation, and management of industrial networking

The IndustrialNet™ Solution includes IndustrialNet™ TX6™, TX5e™ Connectors, Patch Cords, Industrial Automation 4 Post Rack, IndustrialNet™ LC Fiber Optic Bulkhead Adapter and Patch Cords, IndustrialNet™ Ethernet Enclosures, and IndustrialNet™ Stainless Steel Faceplates.

Industrial System Roadmap

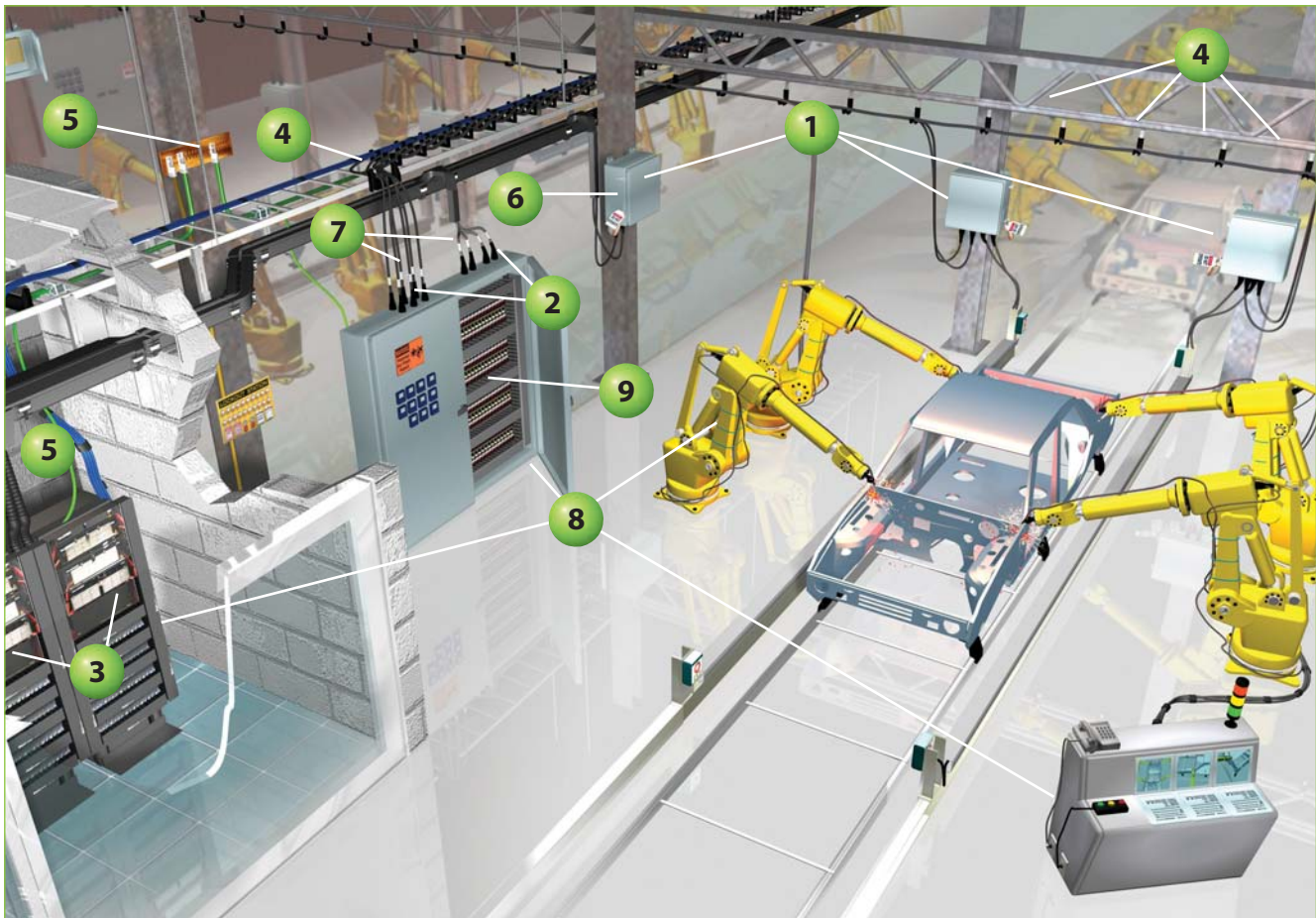

1 IndustrialNet™ Ethernet Enclosures (page N.3) 



5 Power and Grounding Connectors (pages M.1 – M.58)



2 IndustrialNet™ Connectors and Patch Cords (pages N.4 – N.8)



6 Wiring Duct (pages P.1 – P.17)

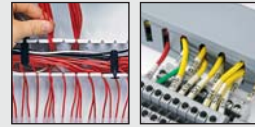

3 Cabinets, Racks, and Cable Management (pages L.1 – L.100) 

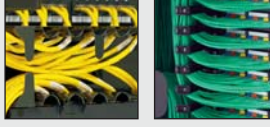

7 Labeling and Identification (pages O.1 – O.30)



4 Cable Management Accessories (pages L.87 – L.88)



8 Cable Ties and Cable Tie Tools (pages P.19 – P.40)



9 DIN Rail Mount Adapter (page N.4)



IndustrialNet™ Ethernet Enclosure, Rack, and Accessories



- Enclosure with pre-configured back plate and side panels to accept Stratix^ 8000, 5700 or Cisco^ IE3000, IE2000 industrial switches with expansion modules and a UPS
- Pre-configured enclosure with cable management, network connectivity, grounding, wire routing accessories with pre-configured back plate and side panels to accept Stratix^ 8000, 5700 or Cisco^ IE3000, IE2000 industrial switches with expansion modules and a UPS
- Pre-configured enclosure has all cable management components installed to get started; includes: Category 6 connectivity, patch cords, patch panel, wiring accessories, ground bar, and cable management
- Reversible hinging door for installation flexibility
- Internal side utility panels pre configured for modular cable management, fiber uplink, and other accessory mounting
- Enclosures meet UL 508 standards and are NEMA Type 4, 12, and IP66 rated for industrial environments
- Wall mountable through enclosure or with removable mounting flanges for mounting flexibility
- 4 post industrial cage nut rack accommodates 19" EIA mountable equipment for use in manufacturing data centers
- 4 post industrial cage nut rack has two adjustable depths for flexibility in equipment mounting
- Industrial Automation DIN rail bracket allows automation equipment to be mounted in 19" EIA rack



IAZ2436



IAZ2436C



IAZ2424



IAZ2424C



IAZ1214



IAZ1214C



Part Number	Part Description	Std. Pkg. Qty.
IAZ2436	Industrial automation zone enclosure with pre-configured backplane for up to two Stratix^ 8000 or Cisco^ IE3000 series industrial switches with expansion modules, UPS, and power supplies.	1
IAZ2436C	Fully pre-configured industrial automation zone enclosure with pre-configured backplane, cable management, and high voltage isolation barrier. For up to two Stratix^ 8000 or Cisco^ IE3000 series industrial switches with expansion modules, UPS, and power supplies.	1
IAZ2424	Industrial automation zone enclosure with pre-configured backplane for one Stratix^ 5700 or Cisco^ IE2000 series industrial switches with UPS and power supplies.	1
IAZ2424C	Fully pre-configured industrial automation zone enclosure with pre-configured backplane, cable management, and high voltage isolation barrier. For one Stratix^ 5700 or Cisco^ IE2000 series industrial switches with expansion modules, UPS, and power supplies.	1
IAZ1214	Industrial automation zone enclosure with pre-configured backplane for one Stratix^ 5700 industrial switch and cabling.	1
IAZ1214C	Industrial automation zone enclosure pre-configured for one Stratix^ 5700 industrial switch, with cable management.	1
PZNF1	NEMA 4X rated compression fitting, ideal for cable diameters of .115" to .250" (2.82mm to 6.35mm).	1
PZNF2	NEMA 4X rated compression fitting, ideal for cable diameters of .230" to .395" (5.84mm to 10.03mm).	1
PZNF3	NEMA 4X rated compression fitting, ideal for cable diameters of .170" to .450" (4.32mm to 11.43mm).	1
PZNDVK	NEMA 4X drain and vent kit.	1

^Cisco is a registered trademark of Cisco Technology, Inc.
^Stratix 8000 is a trademark of Rockwell Automation, Inc.

Table continues on page N.4

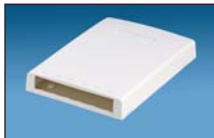
IndustrialNet™ Ethernet Enclosure, Rack, and Accessories (continued)**IAR4P48CN****IABDIN4****CADIN1IG****CBXF6BL-AY****FLCDMCXAQY****CMDSAQLCBL****FXE10-10M1Y****CDPP8RG****FDME8RG**

Part Number	Part Description	Std. Pkg. Qty.
Industrial Rack and Accessories		
IAR4P48CN	Industrial automation 4 post rack system. 24 RU high, cage nut equipment rails. Dimensions: 48.0"H x 23.2"W (1219mm) x (589mm) Depth adjustable at either 23.0" or 29.0" (584mm) or (737mm)	1
IABDIN4	Industrial automation bracket for standard EIA 19" wide rack or cabinet. Installs DIN rail mountable equipment. 4 RU high.	1
Copper Connectivity Accessory		
CADIN1IG	Mini-Com [®] DIN Rail Mount Adapter mounts to standard 35mm DIN rail and accepts any single port Mini-Com [®] Module. Includes a label and label cover.	1
Fiber Uplink Accessories		
CBXF6BL-AY	Mini-Com [®] surface mount box accepts up to six Mini-Com [®] Modules. Includes built-in fiber spool that stores up to 24 meters of buffered fiber optic cable. Icon slots available for optional icons. Dimensions: 0.98"H x 4.70"W x 6.66"L (25.0mm x 119.4mm x 169.2mm)	1
FLCDMCXAQY	LC OptiCam [®] 10Gig [™] 50/125µm OM3/OM4 Multimode Duplex Fiber Optic Connector for 900µm tight-buffered fiber installation.	1
CMDSAQLCBL	Module supplied with one LC Sr./Sr. 10Gig [™] OM3/OM4 SFF Duplex Multimode Fiber Optic Adapter (AQ) with phosphor bronze split sleeves.	1
FXE10-10M1Y	LC to LC multimode duplex patch cord, 1.6mm jacketed cable (two duplex LC connectors on each end) – 10Gig [™] 50/125µm.	1
IndustrialNet™ 8-port DIN Rail Mount Patching Solutions		
FDME8RG	8-port DIN Rail Fiber Optic Enclosure provides enclosed fiber protection for terminated distribution style cabling and includes a PG21 or 3/4 NPT cable cord grip to secure fiber cable(s) exiting the enclosure.	1
CDPP8RG	IndustrialNet™ 8-port DIN rail mount copper patch panel. Mounting latches securely mount unit to standard DIN rail in industrial applications. Can also mount to other surfaces using mounting holes in latches. Includes screws to attach faceplate and Ultimate ID labels and clear label covers.	1

IndustrialNet™ TX6™ Connectors

- Bulkhead provides IP67/IP65 seal when mated with IP67/IP65 plug or patch cord
- Designed to exceed performance requirements of the ANSI/TIA-568-C.2 Category 6 and ISO 11801 2nd Edition Class E standards
- Meet industrial Ethernet specifications from ODVA, TIA, and IEC sealed RJ45 connectors
- Utilize Panduit patented enhanced Giga-TX™ Termination technique for consistent, reliable terminations
- Jack module terminates 4-pair 22 – 26 AWG solid and stranded twisted pair cable
- Gasket and seal made of inert, chemically resistant material
- Connector components are made of high temperature rated material
- Tethered caps maintain seal during unmated connection
- Compatible with leading switch manufacturers' equipment



IAEBH6S

Part Number	Part Description	Std. Pkg. Qty.	Std. Ctn. Qty.
IndustrialNet™ TX6™ UTP Bulkhead Connector			
IAEBH6	Category 6, RJ45, 8-position, 8-wire black industrial bulkhead connector with protective cover.	1	10
IndustrialNet™ TX6™ Shielded Bulkhead Connector			
IAEBH6S	Category 6, RJ45, 8-position, 8-wire shielded black industrial bulkhead connector with protective cover.	1	10

EGJT tool terminates enhanced Giga-TX™ Style Jack Modules, available on page B.92. Not suitable for direct UV applications.

IndustrialNet™ TX6™ Coupler

- Provides convenient plug to plug connection point between the hardened switch and automation device
- Bulkhead provides IP67/IP65 seal when mated with IP67/IP65 plug or patch cord
- Designed to exceed performance requirements of the ANSI/TIA-568-C.2 Category 6 and ISO 11801 2nd Edition Class E standards
- Meet industrial Ethernet specifications from ODVA, TIA, and IEC sealed RJ45 connectors
- Meet requirements of IEEE 802.af and IEEE 802.3at for PoE applications
- Gasket and seal made of inert, chemically resistant material
- Connector components are made of high temperature rated material
- Tethered caps maintain seal during unmated connection
- Compatible with leading switch manufacturers' equipment



IAEBHC6

Part Number	Part Description	Std. Pkg. Qty.	Std. Ctn. Qty.
IAEBHC6	Category 6, RJ45, 8-position, 8-wire black industrial bulkhead coupler with protective cover.	1	10

Acts as one connecting hardware component in channel. Not suitable for direct UV applications.

IndustrialNet™ TX6™ PLUS Patch Cords

- Exceed ANSI/TIA-568-C.2 Category 6 and ISO 11801 Class E standards
- Meet requirements of IEEE 802.3af and IEEE 802.3at for PoE applications
- Each patch cord is 100% performance tested and wired to T568B
- Constructed of industrial Category 6, 24 AWG UTP or 26 AWG shielded stranded cable and modular plugs for superior performance
- Plug contacts plated with 50 microinches of gold for superior performance
- Plug meets all applicable ANSI/TIA/EIA-968-A requirements and exceeds IEC 60603-7 specifications
- Bulkhead provides IP67/IP65 seal when mated to an IP67/IP65, NEMA 6 or 6P bulkhead connector
- Patch cords are pre-terminated and provide IP67/IP65 seal when mated to IP67/IP65 bulkhead connectors
- Available with or without dust caps

**IUTPSP*BL****IUTPSPNC*BL**

Part Number	Part Description	Length		Std. Pkg. Qty.	Std. Ctn. Qty.
		Ft.	m		

IndustrialNet™ TX6™ PLUS UTP Patch Cords

IUTPSP3BL*	Patch cord constructed of industrial grade UTP Category 6 stranded cable with modular plugs. Includes dust caps.	3	0.91	1	10
IUTPSPNC3BL*	Patch cord constructed of industrial grade UTP Category 6 stranded cable with modular plugs. Does not include dust caps.	3	0.91	1	10

IndustrialNet™ TX6™ PLUS Shielded Patch Cords

ISTPSP1MBL**	Patch cord constructed of industrial grade shielded Category 6 stranded cable with shielded modular plugs. Includes dust caps.	3.28	1	1	10
ISTPSPNC1MBL**	Patch cord constructed of industrial grade shielded Category 6 stranded cable with shielded modular plugs. Does not include dust caps.	3.28	1	1	10

*For lengths other than 3 feet (5, 7, 10, 15, or 20 feet) change the length designation in the part number to the desired length.

**For lengths other than 1 meter (2, 3, or 5 meters) change the length designation in the part number to the desired length.

IndustrialNet™ TX5e™ Connectors

- Bulkhead provides IP67/IP65 seal when mated with IP67/IP65 plug or patch cord
- Exceed ANSI/TIA-568-C.2 Category 5e and ISO 11801 2nd Edition Class D standards
- Meet the industrial Ethernet specifications from ODVA, TIA, and IEC for sealed RJ45 connectors
- Utilize Panduit patented Giga-TX™ Termination technique for consistent, reliable terminations
- Terminate 4-pair 22 – 26 AWG solid and stranded twisted pair cable
- Gasket and seal made of inert, chemically resistant material
- High temperature rated material
- Tethered caps maintain seal during unmated connection

**IAEBH5E**

Part Number	Part Description	Std. Pkg. Qty.	Std. Ctn. Qty.
-------------	------------------	----------------	----------------

IndustrialNet™ TX5e™ UTP Bulkhead Connector

IAEBH5E	Category 5e, 8-position, 8-wire industrial connector with protective cover.	1	10
----------------	---	---	----

IndustrialNet™ TX5e™ Shielded Bulkhead Connector

IAEBH5ES	Category 5e, 8-position, 8-wire shielded industrial connector with protective cover.	1	10
-----------------	--	---	----

EGJT tool terminates enhanced Giga-TX™ Style Jack Modules, available on page B.82. Not suitable for direct UV applications.

IndustrialNet™ TX5e™ Coupler

- Provides convenient plug to plug connection point between the hardened switch and automation device
- Bulkhead provides IP67/IP65 seal when mated with IP67/IP65 plug or patch cord
- Designed to exceed performance requirements of the ANSI/TIA-568-C.2 Category 5e and ISO 11801 2nd Edition Class D standards
- Meets industrial Ethernet specifications from ODVA, TIA, and IEC sealed RJ45 connectors
- Gasket and seal made of inert, chemically resistant material
- Connector components are made of high temperature rated material
- Tethered caps maintain seal during unmated connection
- Compatible with leading switch manufacturers' equipment



IAEBHUSBAA

Part Number	Part Description	Std. Pkg. Qty.	Std. Ctn. Qty.
IAEBHC5E	Category 5e, RJ45, 8-position, 8-wire industrial black bulkhead coupler with protective cover.	1	10

Acts as one connecting hardware component in channel.
Not suitable for direct UV applications.

IndustrialNet™ USB Coupler

- Provides interface for transmitting data between devices such as scanners, digital cameras, printers, etc.
- Accepts USB 2.0 Patch Cords and is backwards compatible with USB 1.1 Patch Cords
- Supports cable lengths up to 15 feet between devices
- Bulkhead provides IP67/IP65 seal when mated with IP67/IP65 plug or patch cord
- Meets industrial Ethernet specifications from ODVA, TIA, and IEC sealed RJ45 connectors
- Gasket and seal made of inert, chemically resistant material
- Connector components are made of high temperature rated material
- Tethered caps maintain seal during unmated connection



IAEBHUSBAA

Part Number	Part Description	Std. Pkg. Qty.	Std. Ctn. Qty.
IAEBHUSBAA	IndustrialNet™ Mini-Com® USB 2.0 female A to female A coupler module.	1	10

IndustrialNet™ TX5e™ Modular Plugs

- Bulkhead provides IP67/IP65 seal when mated with IP67/IP65 connector or coupler
- Exceed ANSI/TIA-568-C.2 Category 5e and ISO 11801 2nd Edition Class D standards
- Terminate 24 gauge, stranded or solid conductor with maximum conductor insulation diameter of .040"
- Gasket and seal made of inert, chemically resistant material
- Connector components are made of high temperature rated material
- Tethered caps maintain seal during unmated connection
- Compatible with leading switch manufacturers' equipment



MPI588T

Part Number	Part Description	Std. Pkg. Qty.	Std. Ctn. Qty.
IndustrialNet™ TX5e™ UTP Modular Plug			
MPI588T	Category 5e, RJ45 industrial plug with protective cover.	1	10
IndustrialNet™ TX5e™ Shielded Modular Plug			
MPSI588T	Category 5e, RJ45 shielded industrial plug with protective cover.	1	10

MPT5-8A crimp tool required for termination, available on page B.93.
Not suitable for direct UV applications.

IndustrialNet™ TX5e™ Patch Cords

- Exceed ANSI/TIA-568-C.2 Category 5e and ISO 11801 Class D standards
- Meet requirements of IEEE 802.3af and IEEE 802.3at for PoE applications
- Each patch cord is 100% performance tested and wired to T568B
- Constructed of industrial Category 5e, 24 AWG UTP or 26 AWG shielded stranded cable and modular plugs for superior performance
- Plug contacts plated with 50 microinches of gold for superior performance
- Plug meets all applicable ANSI/TIA/EIA-968-A requirements and exceeds IEC 60603-7 specifications
- Bulkhead provides IP67/IP65 seal when mated to an IP67/IP65, NEMA 6 or 6P bulkhead connector
- Patch cords are pre-terminated and provide IP67/IP65 seal when mated to IP67/IP65 bulkhead connectors
- Available with or without dust caps

IUTPCH*BLY

IUTPCHNC*BLY

Part Number	Part Description	Length		Std. Pkg. Qty.	Std. Ctn. Qty.
		Ft.	m		

IndustrialNet™ TX5e™ UTP Patch Cords

IUTPCH3BLY*	Patch cord constructed of industrial grade UTP Category 5e stranded cable with modular plugs. Includes dust caps.	3	0.91	1	10
IUTPCHNC3BLY*	Patch cord constructed of industrial grade UTP Category 5e stranded cable with modular plugs. Does not include dust caps.	3	0.91	1	10

IndustrialNet™ TX5e™ Shielded Patch Cords

ISTPCH1MBLY**	Patch cord constructed of industrial grade shielded Category 5e stranded cable with shielded modular plugs. Includes dust caps.	3.28	1	1	10
ISTPCHNC1MBLY**	Patch cord constructed of industrial grade shielded Category 5e stranded cable with shielded modular plugs. Does not include dust caps.	3.28	1	1	10

*For lengths other than 3 feet (5, 7, 10, 15, or 20 feet) change the length designation in the part number to the desired length.

**For lengths other than 1 meter (2, 3, or 5 meters) change the length designation in the part number to the desired length.

IndustrialNet™ LC Fiber Optic Bulkhead Adapter and Patch Cords

- IndustrialNet™ Patch Cords are pre-terminated and provide IP67 seal when mated to IP67 bulkhead adapters
- Patch cords built with 62.5µm multimode duplex industrial-grade jacketed fiber cable
- Ideal for daisy-chaining hardened industrial switches between IP66 rated enclosures
- Pigtailed are ideal for routing fiber through conduit
- Patch cords are 100% factory tested for insertion loss
- Insertion loss data is recorded for every multimode patch cord, providing lifetime traceability to a QC number, labeled on each patch cord

IAEF7JMA
IAEF617P-7PM1

Part Number	Part Description	Std. Pkg. Qty.	Std. Ctn. Qty.
-------------	------------------	----------------	----------------

IndustrialNet™ LC Fiber Optic Bulkhead Adapter

IAEF7JMA‡	Industrial LC fiber bulkhead adapter.	1	10
------------------	---------------------------------------	---	----

IndustrialNet™ LC Fiber Optic Patch Cord and Pigtail

IAEF617P-7PM1*	Industrial duplex multimode 62.5µm LC to LC patch cord.	1	10
IAEF617P-NM1**	Industrial duplex multimode 62.5µm LC to pigtail.	1	10

‡Bulkhead includes duplex multimode LC adapter with phosphor bronze split sleeves.

*For lengths other than one meter (2, 3, 10, 20, and 30 meter lengths) change the length description in the part number to the desired lengths.

**Contact Panduit Customer Service for pigtail lengths and/or discrete length patch cords with LC fiber interface.

IndustrialNet™ Data Access Port

- Provides a safe and secure means to maintain and monitor performance of PLC's, VFD, and industrial networks
- Integrated security features prevent access to critical devices by unauthorized personnel
- Allows access by non-arc flash certified personnel reducing cost, increasing efficiencies, and promoting overall safety
- NEMA 4X rating; constructed of aluminum casted base with clear, plastic, impact resistant cover, and modular faceplate



IAPNG5EWH

Part Number	Part Description	Std. Pkg. Qty.	Std. Ctn. Qty.
IAPNG5EWH	Data access port with GFCI and TX5e™ Coupler Module.	1	10
IAPNGWH	Data access port with GFCI.	1	10
IAPNWH	Empty data access port.	1	10



IndustrialNet™ Stainless Steel Faceplates

- Accept IndustrialNet™ Connectors and Adapters
- Impact resistant for light industrial environments
- Rear gasket provides tight seal



IAEFP1

IAEFP2-2G

Part Number	Part Description	No. of Module Spaces	Std. Pkg. Qty.	Std. Ctn. Qty.
IAEFP1	Vertical faceplate accepts one IndustrialNet™ Bulkhead Connector or Adapter.	1	1	10
IAEFP2-2G	Double gang, vertical faceplate accepts two IndustrialNet™ Bulkhead Connectors or Adapters.	2	1	10

All faceplates include mounting screws.

Component Labels for IndustrialNet™ Stainless Steel Faceplates

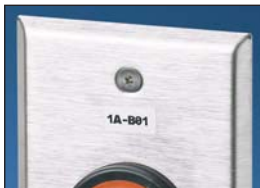

Suggested Label Solutions for TIA/EIA-606-A Compliance

Faceplate Part Number	Laser/Ink Jet Desktop Printer Label	TDP43ME Thermal Transfer Desktop Printer Label	PanTher™ LS8E Hand-Held Printer Label	Cougar™ LS9 Hand-Held Printer Label
IAEFP1	C061X030FJJ	C061X030YPT	C061X030FJC	T031X000FJC-BK
IAEFP2-2G	2 – C061X030FJJ	2 – C061X030YPT	2 – C061X030FJC	T031X000FJC-BK

For complete labeling solutions and product information, reference charts on pages O.1 – O.22.

A.
System
Overview



PHYSICAL INFRASTRUCTURE SYSTEMS

B.
Copper
Systems

C.
Fiber
Optic
Systems

D.
Power
over
Ethernet

E.
Zone
Cabling

F.
Wireless

G.
Outlets

H.
Media
Distribution

I.
Physical
Infrastructure
Management

J.
Overhead &
Underfloor
Routing

K.
Surface
Raceway

L.
Cabinets,
Racks &
Cable
Management

M.
Grounding &
Bonding

N.
Industrial

O.
Labeling &
Identification

P.
Cable
Management
Accessories

Q.
Index

NOTES

LABELING AND IDENTIFICATION

Panduit designs and manufactures a full line of labeling products, software, and printers to assist you with TIA/EIA-606-B compliance. Properly identifying your network allows moves, adds, changes, trouble shooting, and repairs to be accomplished faster and more efficiently to lower the cost of ownership.

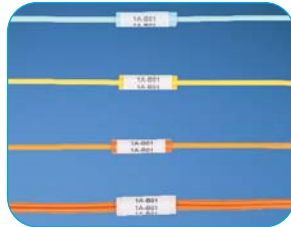

- World-class quality – ISO 9001 and ISO 14001
- High performance and reliability
- Wide variety of complete system solutions to meet the most demanding requirements
- Meet or exceed the requirements of UL, CSA, and TIA/EIA-606-B

Identification solutions are available to comply with TIA/EIA-606-B requirements. For recommended product information and labeling solutions, please refer to the following sections in this catalog: Copper Systems; Fiber Optic Systems; Power over Ethernet; Zone Cabling, Wireless, Outlets; Media Distribution; Physical Infrastructure Management; Overhead & Underfloor Routing; Surface Raceway; Cabinets, Racks, and Cable Management; Grounding and Bonding; and Industrial.

A.
System
Overview

B.
Copper
Systems

C.
Fiber
Optic
Systems

D.
Power
over
Ethernet

E.
Zone
Cabling

F.
Wireless

G.
Outlets

H.
Media
Distribution

I.
Physical
Infrastructure
Management

J.
Overhead &
Underfloor
Routing

K.
Surface
Raceway

L.
Cabinets,
Racks &
Cable
Management

M.
Grounding &
Bonding

N.
Industrial

O.
Labeling &
Identification

P.
Cable
Management
Accessories

Q.
Index

PanTher™ LS8E Hand-Held Thermal Transfer Printer and Accessories

- Cut-to-length functionality eliminates label waste and label trimming labor
- Partial cut feature available to provide tear-apart strips of labels
- P1™ Label Cassette contains an integrated memory device for automatic formatting, recall of last legend used, and number of labels remaining in the cassette
- Market specific labeling tools simplify label creation for network components, panel building, and construction and maintenance
- USB interface for importing data, system upgrades, and printing from a wireless laptop or desktop computer
- Legends can be easily aligned with ports on patch panels and faceplates, eliminating the need for manual spacing and guesswork
- Prints self-laminating cable labels, continuous tapes, and die-cut labels for patch panels, faceplates, and other network applications
- Fast loading label cassette includes both label material and ribbon to make changing labels easy
- Available with an innovative QWERTY keypad that allows faster text entry and label design

**LS8EQ****LS8E**

Part Number	Part Description	Std. Pkg. Qty.
LS8EQ-KIT-ACS	Includes LS8EQ printer with QWERTY keypad, one cassette of S100X150VAC self-laminating labels, six AA alkaline batteries, LS8E-ACS, LS8-CASE, LS8-PCKIT, LS8-IB, LS8-WS, quick reference card and operator's manual.	1
LS8EQ-KIT	Includes LS8EQ printer with QWERTY keypad, one cassette of S100X150VAC self-laminating labels, six AA alkaline batteries, LS8-CASE, LS8-PCKIT, LS8-IB, LS8-WS, quick reference card and operator's manual.	1
LS8EQ	Includes LS8EQ printer with QWERTY keypad, one cassette of S100X150VAC self-laminating labels, six AA alkaline batteries and quick reference card.	1
LS8E-KIT-ACS	Includes LS8E printer, one cassette of S100X150VAC self-laminating labels, six AA alkaline batteries, LS8E-ACS, LS8-CASE, LS8-PCKIT, LS8-IB, LS8-WS, quick reference card and operator's manual.	1
LS8E-KIT	Includes LS8E printer, one cassette of S100X150VAC self-laminating labels, six AA alkaline batteries, LS8-CASE, LS8-PCKIT, LS8-IB, LS8-WS, quick reference card and operator's manual.	1
LS8E	Includes LS8E printer, one cassette of S100X150VAC self-laminating labels, six AA alkaline batteries and quick reference card.	1
LS8E-ACS*‡	120 VAC power adapter for North America.	1
LS8-CASE	Rigid carrying case.	1
LS8-PCKIT	Includes USB cable and PC interface software for importing data, system upgrades, or printing from a wireless laptop or desktop computer.	1
LS8-IB	Protective impact bumper.	1
LS8-WS	Wrist strap.	1
LS8-CLN	Cleaning kit.	1

*Cannot be used to charge batteries.

‡Other adapters available, replace S with A (Australia), C (China), E (Europe), and U (UK).

Reference chart of P1™ Label Cassettes for use with the LS8E hand-held printer.

Cougar™ LS9 Hand-Held Thermal Transfer Printer and Accessories

- Economical identification system provides premium quality solutions at the lowest installed cost
- Cut-to-length functionality eliminates label waste and label trimming labor
- Partial cut feature available to provide tear-apart strips of labels
- P1™ Label Cassette contains an integrated memory device for automatic formatting, recall of last legend used, and number of labels remaining in the cassette
- Legends can be easily aligned with ports on patch panels and faceplates, eliminating the need for manual spacing and guesswork
- Prints a wide variety of continuous tapes for marking of wires/cables, patch panels, faceplates and other network applications
- Fast loading label cassette includes both label material and ribbon to make changing labels easy
- Available with an innovative QWERTY keypad that allows faster text entry and label design

**LS9Q**

Part Number	Part Description	Std. Pkg. Qty.
LS9Q	Includes LS9Q printer with QWERTY keypad, one cassette of T100X000C1C-BK continuous nylon cloth tape, six AA alkaline batteries and quick reference card.	1
LS9	Includes LS9 printer, one cassette of T100X000VPC-BK continuous vinyl tape, six AA alkaline batteries and quick reference card.	1
LS9-ACS*‡	120 VAC power adapter for North America.	1
LS9-CASE	Rigid carrying case.	1
LS9-IB	Protective impact bumper.	1
LS9-WS	Wrist strap.	1
LS9-CLN	Cleaning kit.	1

*Cannot be used to charge batteries.

‡Other adapters available, replace S with A (Australia), C (China), E (Europe), and U (UK).

Reference chart of P1™ Label Cassettes for use with the LS9 hand-held printer.



**Hand-Held
Thermal Transfer
Printing Solutions**



PanTher™ LS8E

Cougar™ LS9

Network Component Labels	Pages O.3 – O.4	
Self-Laminating Labels	Page O.5	
Turn-Tell® Labels	Page O.6	
Marker Plates	Page O.6	
Flag Labels	Page O.6	
Die-Cut Nylon Cloth	Page O.7	
Continuous Nylon Cloth Tape	Page O.7	Page O.7
Die-Cut Heat Shrink Label Cassettes	Page O.8	
Continuous Heat Shrink Label Cassettes	Page O.9	Page O.9
Continuous Tape Cassettes	Page O.10	Page O.10
Ultimate ID® Label Cassettes	Page O.11	Page O.11

P1™ Network Component Label Cassettes for PanTher™ LS8E Hand-Held Thermal Transfer Printer



- P1™ Label Cassette contains an integrated memory device for automatic formatting, recall of last legend used, and number of labels remaining in the cassette
- Fast loading label cassette includes both label material and ribbon to make changing labels easy
- Use for identifying patch panels, faceplates, punchdown blocks and other network systems hardware
- Die-cut labels designed to provide maximum aesthetic quality and appearance
- Available in adhesive polyolefin and non-adhesive polyester materials

<i>Application Description</i>	<i>Typical Application Page</i>	<i>Code</i>
Boxes – Surface Mount, Outlet, Hybrid	G.23 – G.24	BX
Faceplates	G.2	FP
GP6™ Category 6 Punchdown Blocks	B.76	GP
Jack Modules	B.16	JM

<i>Application Description</i>	<i>Typical Application Page</i>	<i>Code</i>
Punchdown Blocks – 110	B.84	PB
Patch Panels	B.30 – B.31	PP
Racks and Cabinets	L.20	RK
Cable Marker Holder – SLCT	B.95	SL

Part Number	Part Description	Width		Height		Std. Pkg. Qty.	Std. Ctn. Qty.
		In.	mm	In.	mm		
C061X030FJC	White, adhesive polyolefin label, 500/cassette, Mini-Com® 1-port identifier. Application codes: BX, FP, and PP.	0.61	15.5	0.30	7.6	1	10
C125X030FJC	White, adhesive polyolefin label, 200/cassette, Mini-Com® 2-port identifier. Application codes: BX, FP, and PP.	1.25	31.8	0.30	7.6	1	10
C138X019FJC	White, adhesive polyolefin label, 200/cassette, Mini-Com® Module identifier. Application code: JM.	1.38	35.1	0.19	4.8	1	10
C150X030Y1C	White, non-adhesive polyester label, 75/cassette, Mini-Com® 3-port identifier. Application codes: FP.	1.50	38.1	0.30	7.6	1	10
C188X030FJC	White, adhesive polyolefin label, 150/cassette, Mini-Com® 3-port identifier. Application code: FP.	1.88	47.8	0.30	7.6	1	10
C195X040Y1C	White, non-adhesive polyester label, 100/cassette, single-gang faceplate. Application code: FP.	1.95	49.5	0.40	10.2	1	10
C200X100FJC	White, adhesive polyolefin label, 150/cassette, SLCT bundle marker identifier. Application code: SL, RK.	2.00	50.8	1.00	25.4	1	10
C252X030FJC	White, adhesive polyolefin label, 125/cassette, Mini-Com® 4-port identifier. Application codes: BX, FP, and PP.	2.52	64.0	0.30	7.6	1	10

Order number of cassettes required.

Table continues on page O.4

P1™ Network Component Label Cassettes for PanTher™ LS8E Hand-Held Thermal Transfer Printer (continued)

Part Number	Part Description	Width		Height		Std. Pkg. Qty.	Std. Ctn. Qty.
		In.	mm	In.	mm		
C261X030FJC	White, adhesive polyolefin label, 125/cassette, Mini-Com® 4-port identifier. Application codes: FP and PP.	2.61	66.3	0.30	7.6	1	10
C261X035Y1C	White, non-adhesive polyester label, 75/cassette, Mini-Com® 4-port identifier. Application codes: FP and PP.	2.61	66.3	0.35	8.9	1	10
C282X030Y1C	White, non-adhesive polyester label, 75/cassette, Mini-Com® 4-port identifier. Application codes: FP and PP.	2.82	71.6	0.30	7.6	1	10
C288X040Y1C	White, non-adhesive polyester label, 75/cassette, double-gang faceplate. Application code: FP.	2.88	73.2	0.40	10.2	1	10
C315X030FJC	White, adhesive polyolefin label, 100/cassette, Mini-Com® 5-port identifier. Application code: FP.	3.15	80.0	0.30	7.6	1	10
C379X030FJC	White, adhesive polyolefin label, 75/cassette, Mini-Com® 6-port identifier. Application code: FP.	3.79	96.3	0.30	7.6	1	10
C390X030Y1C	White, non-adhesive polyester label, 50/cassette, Mini-Com® 6-port identifier. Application code: PP.	3.90	99.1	0.30	7.6	1	10
C750X050Y1C	White, non-adhesive polyester label, 30/cassette, 110 block identifier. Application code: PB.	7.50	190.5	0.50	12.7	1	10
C788X050Y1C	White, non-adhesive polyester label, 30/cassette, GP6™ System identifier. Application code: GP.	7.88	200.2	0.50	12.7	1	10

Order number of cassettes required.

P1™ Self-Laminating Label Cassettes for PanTher™ LS8E Hand-Held Thermal Transfer Printer



- P1™ Label Cassette contains an integrated memory device for automatic formatting, recall of last legend used, and number of labels remaining in the cassette
- Fast loading label cassette includes both label material and ribbon to make changing labels easy
- Self-laminating adhesive labels for wire/cable identification include a colored print-on area and clear overlamine

Part Number	Part Description	Width		Length		Print-On Height		Min. Cable O.D.		Max. Cable O.D.		Std. Pkg. Qty.	Std. Ctn. Qty.
		In.	mm	In.	mm	In.	mm	In.	mm	In.	mm		
S050X075VAC	White print-on area, vinyl label for 18 – 14 AWG wires, 450/cassette.	0.50	12.7	0.75	19.1	0.25	6.4	0.08	2.0	0.16	4.0	1	10
S050X125VAC	White print-on area, vinyl label for 12 – 10 AWG wire/cable and Category 3 UTP cable, 225/cassette.	0.50	12.7	1.25	31.8	0.38	9.7	0.12	3.1	0.28	7.0	1	10
S050X150VAC	White print-on area, vinyl label for 10 – 6 AWG wire/cable, Category 5e/6/6A UTP and Category 5e FTP cable, 200/cassette.	0.50	12.7	1.50	38.1	0.50	12.7	0.16	4.0	0.32	8.1	1	10
S075X075VAC	White print-on area, vinyl label for 18 – 14 AWG wires, 350/cassette.	0.75	19.1	0.75	19.1	0.25	6.4	0.08	2.0	0.16	8.1	1	10
S075X100VAC	White print-on area, vinyl label for 12 – 10 AWG wires, 275/cassette.	0.75	19.1	1.00	25.4	0.38	9.7	0.12	3.1	0.16	4.0	1	10
S075X125VAC	White print-on area, vinyl label for 12 – 10 AWG wire/cable and Category 3 UTP cable, 225/cassette.	0.75	19.1	1.25	31.8	0.38	9.7	0.12	3.1	0.28	7.0	1	10
S075X150VAC	White print-on area, vinyl label for 10 – 6 AWG wire/cable, Category 5e/6/6A UTP and Category 5e FTP cable, 200/cassette.	0.75	19.1	1.50	38.1	0.50	12.7	0.16	4.0	0.32	8.1	1	10
S100X075VAC	White print-on area, vinyl label for 18 – 14 AWG wires, 350/cassette.	1.00	25.4	0.75	19.1	0.25	6.4	0.08	2.0	0.16	4.0	1	10
S100X125VAC	White print-on area, vinyl label for 12 – 10 AWG wire/cable Category 3 UTP cable, 225/cassette.	1.00	25.4	1.25	31.8	0.38	9.7	0.12	3.1	0.28	7.0	1	10
S100X150VAC*	White print-on area, vinyl label for 10 – 6 AWG wire/cable, Category 5e/6/6A UTP and Category 5e FTP cable, 200/cassette.	1.00	25.4	1.50	38.1	0.50	12.7	0.16	4.0	0.32	8.1	1	10
S100X160VAC	White print-on, self-laminating vinyl label 175/cassette. For use with NWSLC-2Y and NWSLC-3Y.	1.00	25.4	1.60	40.6	0.80	20.3	0.25	6.4	0.25	6.4	1	10
S100X220VAC	White print-on, self-laminating vinyl label, 125/cassette. For use with NWSLC-7Y.	1.00	25.4	2.20	55.9	1.10	27.9	0.35	8.9	0.35	8.9	1	10
S100X225VAC*	White print-on area, vinyl label for 8 – 4 AWG wire/cable, Category 6 FTP and Category 6A/10Gig cable, 125/cassette.	1.00	25.4	2.25	57.2	0.75	19.1	0.24	6.1	0.48	12.2	1	10
S100X400VAC	White print-on area, vinyl label for 2 – 1 AWG wires, 75/cassette.	1.00	25.4	4.00	101.6	1.00	25.4	0.32	8.1	0.95	24.3	1	10
S100X650VAC	White print-on area, vinyl label for 1/0-250 MCM wires, 50/cassette.	1.00	25.4	6.50	165.1	1.50	38.1	0.48	12.2	1.59	40.4	1	10

*Other colors available, replace A with B (Blue), D (Green), H (Red), and I (Yellow).
Order number of cassettes required.

A.
System
Overview

B.
Copper
Systems

C.
Fiber
Optic
Systems

D.
Power
over
Ethernet

E.
Zone
Cabling

F.
Wireless

G.
Outlets

H.
Media
Distribution

I.
Physical
Infrastructure
Management

J.
Overhead &
Underfloor
Routing

K.
Surface
Raceway

L.
Cabinets,
Racks &
Cable
Management

M.
Grounding &
Bonding

N.
Industrial

O.
Labeling &
Identification

P.
Cable
Management
Accessories

Q.
Index

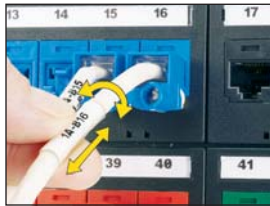
**NEW! P1™ Turn-Tell™ Label Cassettes for PanTher™ LS8E Hand-Held Thermal Transfer Printer**

- Fast loading P1™ Label Cassette includes both label material and ribbon to make changing labels easy
- Innovative label design allows labels to rotate for visibility from any angle, and for repositioning on the wire/cable to align legends and improve aesthetics
- Labels can be easily installed on existing terminated wires and assemblies without disconnecting the wires/cables
- Temperature range: -40°F to 200°F (-40°C to 93°C)

Part Number	Width		Length		Print-On Area Height		Min. Cable O.D.		Max. Wire O.D.		Std. Pkg. Qty.	Std. Ctn. Qty.
	In.	mm	In.	mm	In.	mm	In.	mm	In.	mm		
R100X075V1C	1.00	25.4	0.75	19.1	0.25	6.4	0.12	3.1	0.16	4.1	1	10
R100X125V1C	1.00	25.4	1.25	31.8	0.38	9.7	0.16	4.1	0.22	5.6	1	10
R100X150V1C	1.00	25.4	1.50	38.1	0.50	12.7	0.22	5.6	0.28	7.1	1	10
R100X225V1C	1.00	25.4	2.25	57.2	0.75	19.1	0.28	7.1	0.39	9.9	1	10

For other colors, replace suffix V1C (White) with V2C (Blue), V3C (Green), V7C (Red), or V8C (Yellow).

P1™ Marker Plate Label Cassettes for PanTher™ LS8E Hand-Held Thermal Transfer Printer

- Fast loading P1™ Label Cassette includes both label material and ribbon to make changing labels easy
- Marker plates are designed for use on larger diameter wire/cables and may be applied after all terminations are complete
- Meets requirements for MIL-STD-202F, Notice 12 Method 215J
- Temperature range: -40°F to 176°F (-40°C to 80°C)

Part Number	Color	Width		Height		Print-On Area Width		Labels Per Cassette	Std. Pkg. Qty.	Std. Ctn. Qty.
		In.	mm	In.	mm	In.	mm			
M300X050Y6C	Yellow	3.00	76.2	0.50	12.7	1.80	45.7	50	1	10
M300X050Y7C	White	3.00	76.2	0.50	12.7	1.80	45.7	50	1	10

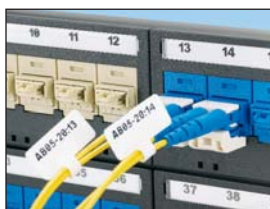
P1™ Flag Label Cassettes for PanTher™ LS8E Hand-Held Thermal Transfer Printer

- Fast loading P1™ Label Cassette includes both label material and ribbon to make changing labels easy
- Provides larger labeling area for small cables
- Innovative design allows flag labels to be applied in either adhesive or non-adhesive orientations
- Temperature range: -40°F to 302°F (-40°C to 150°C)

Part Number	Color	Width		Length		Min. Cable O.D.		Max. Wire O.D.		Wire Range	Labels Per Cassette	Std. Pkg. Qty.	Std. Ctn. Qty.
		In.	mm	In.	mm	In.	mm	In.	mm				
F100X150AJC	White	1.00	25.4	1.50	38.1	0.12	3.1	0.20	5.1	12-10 AWG	200	1	10

P1™ Die-Cut Nylon Cloth Labels for PanTher™ LS8E Hand-Held Thermal Transfer Printer



- Labels offer crisp, clear legends with superior legibility
- Die-cut labels designed to provide maximum aesthetic quality and appearance

Part Number	Part Description	Length		Width		Std. Pkg. Qty.	Std. Ctn. Qty.
		In.	mm	In.	mm		
N050X075C1C	White, nylon cloth label, 250/cassette.	0.75	19.1	0.50	12.7	1	10
N050X075C2C	Yellow, nylon cloth label, 250/cassette.	0.75	19.1	0.50	12.7	1	10
N050X125C1C	White, nylon cloth label, 150/cassette.	1.25	31.8	0.50	12.7	1	10
N050X125C2C	Yellow, nylon cloth label, 150/cassette.	1.25	31.8	0.50	12.7	1	10
N100X075C1C	White, nylon cloth label, 250/cassette.	0.75	19.1	1.00	25.4	1	10
N100X075C2C	Yellow, nylon cloth label, 250/cassette.	0.75	19.1	1.00	25.4	1	10
N100X125C1C	White, nylon cloth label, 150/cassette.	1.25	31.8	1.00	25.4	1	10
N100X125C2C	Yellow, nylon cloth label, 150/cassette.	1.25	31.8	1.00	25.4	1	10

P1™ Continuous Nylon Cloth Tape for PanTher™ LS8E or Cougar™ LS9 Hand-Held Thermal Transfer Printers

- Fast loading P1™ label cassette includes both label material and ribbon to make changing labels easy
- Non-laminated adhesive labels for wire/cable identification
- Nylon cloth labels can be repositioned or reused

Part Number	Part Description	Height		Length		Std. Pkg. Qty.	Std. Ctn. Qty.
		In.	mm	Ft.	m		
T038X000C1C-BK	Black on white, nylon cloth label tape.	0.38	9.7	18.0	5.5	1	10
T038X000C2C-BK	Black on yellow, nylon cloth label tape.	0.38	9.7	18.0	5.5	1	10
T050X000C1C-BK	Black on white, nylon cloth label tape.	0.50	12.7	18.0	5.5	1	10
T050X000C2C-BK	Black on yellow, nylon cloth label tape.	0.50	12.7	18.0	5.5	1	10
T075X000C1C-BK	Black on white, nylon cloth label tape.	0.75	19.1	18.0	5.5	1	10
T075X000C2C-BK	Black on yellow, nylon cloth label tape.	0.75	19.1	18.0	5.5	1	10
T100X000C1C-BK	Black on white, nylon cloth label tape.	1.00	25.4	18.0	5.5	1	10
T100X000C2C-BK	Black on yellow, nylon cloth label tape.	1.00	25.4	18.0	5.5	1	10

P1™ Die-Cut Heat Shrink Label Cassettes for PanTher™ LS8E Hand-Held Thermal Transfer Printer



- P1™ Label Cassette contains an integrated memory device for automatic formatting, recall of last legend used, and number of labels remaining in the cassette
- Fast loading label cassette includes both label material and ribbon to make changing labels easy
- Meet print performance requirements of MIL-M-81531 and MIL-STD-202F Method 215A, Solution A, C, and D
- Meet UL Standard 224 for flammability
- Shrink ratio 3:1
- Each cassette contains roll of die-cut non-adhesive flattened polyolefin

Part Number	Part Description	Width		Length		Min. Cable Diameter		Max. Cable Diameter		Std. Pkg. Qty.	Std. Ctn. Qty.
		In.	mm	In.	mm	In.	mm	In.	mm		
H100X025H1C	White, 1/8" diameter heat shrinkable polyolefin, 22 – 16 AWG, 100/cassette.	0.25	6.4	1.00	25.4	0.04	1.0	0.13	3.3	1	10
H100X025H2C	Yellow, 1/8" diameter heat shrinkable polyolefin, 22 – 16 AWG, 100/cassette.	0.25	6.4	1.00	25.4	0.04	1.0	0.13	3.3	1	10
H100X034H1C	White, 3/16" diameter heat shrinkable polyolefin, 18 – 12 AWG, 100/cassette.	0.34	8.6	1.00	25.4	0.06	1.5	0.19	4.8	1	10
H100X034H2C	Yellow, 3/16" diameter heat shrinkable polyolefin, 18 – 12 AWG, 100/cassette.	0.34	8.6	1.00	25.4	0.06	1.5	0.19	4.8	1	10
H100X044H1C	White, 1/4" diameter heat shrinkable polyolefin, 16 – 10 AWG, 100/cassette.	0.44	11.2	1.00	25.4	0.08	2.0	0.25	6.4	1	10
H100X044H2C	Yellow, 1/4" diameter heat shrinkable polyolefin, 16 – 10 AWG, 100/cassette.	0.44	11.2	1.00	25.4	0.08	2.0	0.25	6.4	1	10
H100X064H1C	White, 3/8" diameter heat shrinkable polyolefin, 12 – 6 AWG, 75/cassette.	0.64	16.3	1.00	25.4	0.13	3.3	0.38	9.7	1	10
H100X064H2C	Yellow, 3/8" diameter heat shrinkable polyolefin, 12 – 6 AWG, 75/cassette.	0.64	16.3	1.00	25.4	0.13	3.3	0.38	9.7	1	10
H100X084H1C	White, 1/2" diameter heat shrinkable polyolefin, 8 – 1 AWG, 75/cassette.	0.84	21.3	1.00	25.4	0.17	4.3	0.50	12.7	1	10
H100X084H2C	Yellow, 1/2" diameter heat shrinkable polyolefin, 8 – 1 AWG, 75/cassette.	0.84	21.3	1.00	25.4	0.17	4.3	0.50	12.7	1	10

Order number of cassettes required.

P1™ Continuous Heat Shrink Label Cassettes for PanTher™ LS8E and Cougar™ LS9 Hand-Held Thermal Transfer Printers

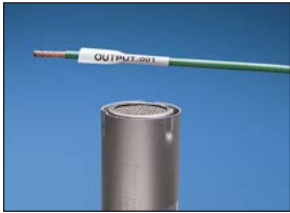

- P1™ Label Cassette contains an integrated memory device for automatic formatting, recall of last legend used, and number of labels remaining in the cassette
- Fast loading label cassette includes both label material and ribbon to make changing labels easy
- Meet print performance requirements of MIL-M-81531 and MIL-STD-202F Method 215A, Solution A, C, and D
- Meet UL Standard 224 for flammability
- Shrink ratio 3:1
- Each cassette contains a continuous roll of non-adhesive flattened polyolefin that can be cut-to-length

Part Number	Part Description	Width		Length		Min. Cable Diameter		Max. Cable Diameter		Std. Pkg. Qty.	Std. Ctn. Qty.
		In.	mm	Ft.	m	In.	mm	In.	mm		
H000X025H1C	White, 1/8" diameter heat shrinkable polyolefin, 22 – 16 AWG.	0.25	6.4	8.0	2.4	0.04	1.0	0.13	3.3	1	10
H000X025H2C	Yellow, 1/8" diameter heat shrinkable polyolefin, 22 – 16 AWG.	0.25	6.4	8.0	2.4	0.04	1.0	0.13	3.3	1	10
H000X034H1C	White, 3/16" diameter heat shrinkable polyolefin, 18 – 12 AWG.	0.34	8.6	8.0	2.4	0.06	1.5	0.19	4.8	1	10
H000X034H2C	Yellow, 3/16" diameter heat shrinkable polyolefin, 18 – 12 AWG.	0.34	8.6	8.0	2.4	0.06	1.5	0.19	4.8	1	10
H000X044H1C	White, 1/4" diameter heat shrinkable polyolefin, 16 – 10 AWG.	0.44	11.2	6.0	1.8	0.08	2.0	0.25	6.4	1	10
H000X044H2C	Yellow, 1/4" diameter heat shrinkable polyolefin, 16 – 10 AWG.	0.44	11.2	6.0	1.8	0.08	2.0	0.25	6.4	1	10
H000X064H1C	White, 3/8" diameter heat shrinkable polyolefin, 12 – 6 AWG.	0.64	16.3	6.0	1.8	0.13	3.3	0.38	9.7	1	10
H000X064H2C	Yellow, 3/8" diameter heat shrinkable polyolefin, 12 – 6 AWG.	0.64	16.3	6.0	1.8	0.13	3.3	0.38	9.7	1	10
H000X084H1C	White, 1/2" diameter heat shrinkable polyolefin, 8 – 1 AWG.	0.84	21.3	6.0	1.8	0.17	4.3	0.50	12.7	1	10
H000X084H2C	Yellow, 1/2" diameter heat shrinkable polyolefin, 8 – 1 AWG.	0.84	21.3	6.0	1.8	0.17	4.3	0.50	12.7	1	10

Order number of cassettes required.

P1™ Continuous Tape Cassettes for PanTher™ LS8E and Cougar™ LS9 Hand-Held Thermal Transfer Printers

- P1™ Label Cassette contains an integrated memory device for automatic formatting, recall of last legend used, and number of labels remaining in the cassette
- Labels for general network identification
- Available in a variety of colors, widths, and adhesive materials including continuous polyolefin, polyester, and vinyl
- Fast loading label cassette includes both label material and ribbon to make changing labels easy
- For flat label applications only



Part Number	Part Description	Height		Length		Std. Pkg. Qty.	Std. Ctn. Qty.
		In.	mm	Ft.	m		
T019X000FJC-BK	Black on white, polyolefin module label tape.	0.19	4.8	25.0	7.6	1	10
T024X000FJC-BK	Black on white, polyolefin tape, terminal block label.	0.24	6.1	25.0	7.6	1	10
T024X000VPC-BK	Black on white, vinyl tape.	0.24	6.1	25.0	7.6	1	10
T024X000VYC-WH	White on black, vinyl tape.	0.24	6.1	25.0	7.6	1	10
T024X000YKC-BK	Black on clear, polyester continuous tape.	0.24	6.1	25.0	7.6	1	10
T031X000FJC-BK	Black on white, polyolefin tape, terminal block label.	0.31	7.9	25.0	7.6	1	10
T038X000FJC-BK	Black on white, polyolefin tape, terminal block label.	0.38	9.7	25.0	7.6	1	10
T038X000VPC-BK	Black on white, vinyl tape.	0.38	9.7	25.0	7.6	1	10
T038X000VQC-BK*	Black on blue, vinyl tape.	0.38	9.7	25.0	7.6	1	10
T038X000VSC-BK*	Black on green, vinyl tape.	0.38	9.7	25.0	7.6	1	10
T038X000VUC-BK	Black on orange, vinyl tape.	0.38	9.7	25.0	7.6	1	10
T038X000VWC-BK*	Black on red, vinyl tape.	0.38	9.7	25.0	7.6	1	10
T038X000VXC-BK	Black on yellow, vinyl tape.	0.38	9.7	25.0	7.6	1	10
T038X000VYC-WH	White on black, vinyl tape.	0.38	9.7	25.0	7.6	1	10
T038X000YKC-BK	Black on clear, polyester tape.	0.38	9.7	25.0	7.6	1	10
T050X000VPC-BK	Black on white, vinyl tape.	0.50	12.7	25.0	7.6	1	10
T050X000VQC-BK*	Black on blue, vinyl tape.	0.50	12.7	25.0	7.6	1	10
T050X000VSC-BK*	Black on green, vinyl tape.	0.50	12.7	25.0	7.6	1	10
T050X000VUC-BK	Black on orange, vinyl tape.	0.50	12.7	25.0	7.6	1	10
T050X000VWC-BK*	Black on red, vinyl tape.	0.50	12.7	25.0	7.6	1	10
T050X000VXC-BK	Black on yellow, vinyl tape.	0.50	12.7	25.0	7.6	1	10
T050X000VYC-WH	White on black, vinyl tape.	0.50	12.7	25.0	7.6	1	10
T050X000YKC-BK*	Black on clear, polyester tape.	0.50	12.7	25.0	7.6	1	10
T075X000VPC-BK	Black on white, vinyl tape.	0.75	19.1	25.0	7.6	1	10
T075X000VQC-BK*	Black on blue, vinyl tape.	0.75	19.1	25.0	7.6	1	10
T075X000VSC-BK*	Black on green, vinyl tape.	0.75	19.1	25.0	7.6	1	10
T075X000VUC-BK	Black on orange, vinyl tape.	0.75	19.1	25.0	7.6	1	10
T075X000VWC-BK*	Black on red, vinyl tape.	0.75	19.1	25.0	7.6	1	10
T075X000VXC-BK	Black on yellow, vinyl tape.	0.75	19.1	25.0	7.6	1	10
T075X000VYC-WH	White on black, vinyl continuous tape.	0.75	19.1	25.0	7.6	1	10
T075X000YKC-BK	Black on clear, polyester tape.	0.75	19.1	25.0	7.6	1	10
T100X000VPC-BK	Black on white, vinyl tape.	1.00	25.4	25.0	7.6	1	10
T100X000VQC-BK*	Black on blue, vinyl tape.	1.00	25.4	25.0	7.6	1	10
T100X000VSC-BK*	Black on green, vinyl tape.	1.00	25.4	25.0	7.6	1	10
T100X000VUC-BK	Black on orange, vinyl tape.	1.00	25.4	25.0	7.6	1	10
T100X000VWC-BK*	Black on red, vinyl tape.	1.00	25.4	25.0	7.6	1	10
T100X000VXC-BK	Black on yellow, vinyl tape.	1.00	25.4	25.0	7.6	1	10
T100X000VYC-WH	White on black, vinyl tape.	1.00	25.4	25.0	7.6	1	10
T100X000YKC-BK*	Black on clear, polyester tape.	1.00	25.4	25.0	7.6	1	10

*Available with white ribbon, replace BK suffix with WH.
Order number of cassettes required.

P1™ Ultimate ID® Label Cassette for use with PanTher™ LS8E and Cougar™ LS9 Hand-Held Thermal Transfer Printers

- P1™ Label Cassette contains an integrated memory device for automated formatting, recall of last legend used, and number of labels remaining in the cassette
- Fast loading label cassette includes both label material and ribbon to make changing labels easy
- Label cassette designed for use with Ultimate ID® Faceplates, Patch Panels, Marker Ties, Modular Furniture Faceplates, and Surface Mount Boxes
- Labels assist in the compliance of TIA/EIA-606-B labeling standard
- Available in non-adhesive polyester material

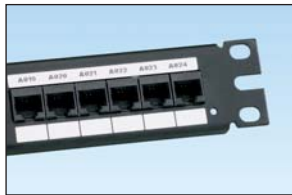

Part Number	Part Description	Height		Length		Std. Pkg. Qty.	Std. Ctn. Qty.
		In.	mm	Ft.	m		
UILS8BW	White, non-adhesive polyester label cassette.	0.236	6.0	25.0	7.6	1	10

Order number of cassettes required.

Easy-Mark™ Labeling Software

- Easy-Mark™ Labeling Software simplifies label creation for the specific needs of your applications
- Instructions and user interface are available in English, French, German, Italian, Spanish, Korean, Japanese, Chinese, and Portuguese
- Intuitive interview process allows automatic generation of labels and signs
- Software selects and formats the optimum label for your specific application
- **WYSIWYG** (What You See Is What You Get) user interface, alpha/numeric serialization, data import, symbol import
- Upgrades are available on the Panduit website under Support/Software, Firmware & Printers/Easy-Mark Labeling Software
- Supports most Windows^ fonts drivers for standard thermal transfer, dot matrix, laser and ink jet, including Panduit thermal transfer printers

System Requirements:

- Windows^ 2000, XP, Vista, or 7; 64MB hard drive space and 64MB RAM (256MB RAM recommended)
- Microsoft.NET Framework 2.0 or higher



Part Number	Part Description	Std. Pkg. Qty.	Std. Ctn. Qty.
PROG-EMCD3	Easy-Mark™ Labeling Software, CD-ROM	1	10
PROG-EM2GO	Easy-Mark™ Labeling Software - USB Flash Drive	1	10

^WINDOWS is a registered trademark of Microsoft Corporation in the United States and/or other countries.

CAD-Connect™ Labeling Software

- Facilitates quick and easy organization of identifiers from CAD for printing within Easy-Mark™ Labeling Software
- Easily capture and organize CAD data for future use and documentation
- Saves time and reduces errors by utilizing identifiers previously created in CAD files to eliminate manual entry of data into labeling software
- Compatible with full versions of AutoCAD* 2008 or newer and Visio^ version 2002 or newer
- Exports to alternative formats such as Excel^ (XLS) or Text (CSV) files for future use and documentation
- Upgrades are available on the Panduit website under Support/Software, Firmware & Printers/CAD-Connect Labeling Software

System Requirements:

- 64 MB hard drive space and 64 MB RAM (256 MB RAM recommended)
- Mouse or compatible pointing device
- Windows^ 2000, XP, Vista, or Windows^ 7
- CD-ROM Drive
- Microsoft.NET Framework 2.0 or higher



Part Number	Part Description	Std. Pkg. Qty.	Std. Ctn. Qty.
PROG-CCCD	CAD-Connect™ Labeling Software, including Easy-Mark™ Labeling Software, CD-ROM.	1	10

*AutoCAD is a registered trademark of Autodesk, Inc.

^Visio, WINDOWS, and EXCEL are registered trademarks of Microsoft Corporation in the United States and/or other countries.

NEW!

TDP43ME Thermal Transfer Desktop Printer and Accessories

- Creates durable, crisp, clear legends and graphics that offer superior legibility
- Prints a wide variety of label sizes and materials
- Prints durable legends for harsh industrial environments
- Fine resolution for small type characters and images
- Solid printing of large characters and shapes
- Connects quickly and easily to PC, reduces time required for learning how to operate the printer and make adjustments
- Easy-Mark™ Labeling Software included with printer
- Up to 4 inches per second print speed
- Auto-sensing label gap and black mark sensors
- One button operation, and automatic self test
- Connects quickly and easily to PC, and offers connectivity flexibility to print by USB, parallel, or Ethernet
- Easy ribbon loading reduces printer down time
- Allows use in office or remote locations



Part Number	Part Description	Std. Pkg. Qty.
TDP43ME	300 dpi printer; includes printer, Panduit® Easy-Mark™ Labeling Software, RMEH4BL hybrid black ribbon, AC power adapter with US power cord, USB cable, user manual, quick start card, and driver disk.	1
TDP43ME-KIT	TDP43ME printer kit. Includes: printer, Panduit® Easy-Mark™ Labeling Software, RMEH4BL hybrid black ribbon, AC power adapter with US power cord, USB cable, user manual, quick start card, TDP43ME-RS Roll Stand, TDP43ME-CASE, one roll of S100X150VATY labels, external roll stand, and driver disk.	1
TDP43ME-RS	External label roll stand for TDP43ME printer; used to rear feed labels that are supplied on 3" cores.	1
TDP43ME-CASE	Hardside carrying case accommodates printer, AC power adapter, ribbons, printer cable, external roll stand, labels, and tools.	1
TDP43ME-AC	Replacement AC power adapter with power cord (US cord only).	1
TDP43ME-CUTTER	Optional power/automatic cutter for TDP43ME thermal transfer desktop printer; easy to install for automatic cutting of labels.	1
PTR-CLN	Printer cleaning kit – contains bottle of cleaning solution with MSDS, cleaning pen, swabs, alcohol wipes, and cleaning instructions.	1

Ribbons for Use with the TDP43ME Thermal Transfer Desktop Printer



- Ribbons load easily into the TDP43ME printer
- Resin - recommended for use with polyester and white polyimide component labels, marker plates, raised panel labels, nylon cloth labels, and continuous vinyl tape
- Hybrid - recommended for use with heat shrink, self-laminating, Turn-Tell® labels, and tan polyimide, and vinyl cloth labels
- RMER4BL-A black resin - recommended for use with nuclear marker plates

Part Number	Part Description	Width		Length		Std. Pkg. Qty.	Std. Ctn. Qty.
		In.	mm	Ft.	m		
RMEH2BL	Black hybrid thermal transfer ribbon, 2.50" x 300'. For use with TDP43ME desktop printer. Use with heat shrink, self-laminating, Turn-Tell®, and vinyl cloth labels.	2.50	63.5	300.0	91.4	1	12
RMEH4BL	Black hybrid thermal transfer ribbon, 4.25" x 300'. For use with TDP43ME desktop printer. Use with heat shrink, self-laminating, Turn-Tell®, and vinyl cloth labels.	4.25	108.0	300.0	91.4	1	12
RMER2BL	Black resin thermal transfer ribbon, 2.50" x 300'. For use with TDP43ME desktop printer. Use with polyester and polyimide labels, continuous vinyl tape, marker plates, and raised panel labels.	2.50	63.5	300.0	91.4	1	12
RMER4BL	Black resin thermal transfer ribbon, 4.25" x 300'. For use with TDP43ME desktop printer. Use with polyester and polyimide labels, continuous vinyl tape, marker plates, and raised panel labels.	4.25	108.0	300.0	91.4	1	12
RMER2WH	White resin thermal transfer ribbon, 2.50" x 300'. For use with TDP43ME desktop printer. Use with continuous vinyl tape, marker plates, and raised panel labels.	2.50	63.5	300.0	91.4	1	6
RMER4WH	White resin thermal transfer ribbon, 4.25" x 300'. For use with TDP43ME desktop printer. Use with continuous vinyl tape, marker plates, and raised panel labels.	4.25	108.0	300.0	91.4	1	6
RMER4RD	Red resin ribbon, 4.25" x 300'. For use with TDP43ME desktop printer. Use with continuous vinyl tape, marker plates, and raised panel labels.	4.25	108.0	300.0	91.4	1	6
RMER4BL-A	Black resin thermal transfer ribbon, 4.25" x 300'. For use with TDP43ME desktop printer. Use with nuclear marker plates.	4.25	108.0	300.0	91.4	1	12

Order number of ribbons required in multiples of Standard Package Quantity.

Thermal Transfer Component Labels



- Use for identifying patch panels, faceplates, punchdown blocks and other network systems hardware
- Die-cut labels designed to provide maximum aesthetic quality and appearance
- Available in adhesive polyester and non-adhesive polyester materials
- Use with Panduit thermal transfer resin ribbons

<i>Application Description</i>	<i>Typical Application Page</i>	<i>Code</i>
Boxes – Surface Mount, Outlet, Hybrid	G.22 – G.26	BX
Faceplates	G.3 – G.14	FP
GP6™ Category 6 Punchdown Blocks	B.81	GP
Jack Modules	B.16 – B.17	JM

<i>Application Description</i>	<i>Typical Application Page</i>	<i>Code</i>
Punchdown Blocks – 110	B.84	PB
Patch Panels	B.22 – B.24	PP
Racks and Cabinets	L.11	RK
Cable Marker Holder – SLCT	B.95	SL

Part Number	Part Description	Width		Height		Std. Pkg. Qty.	Std. Ctn. Qty.
		In.	mm	In.	mm		
C061X030YPT	White, adhesive polyester label, Mini-Com® 1-port identifier. Application codes: BX, FP, and PP.	0.61	15.5	0.30	7.6	2500	10000
C100X050YPT	White, component label, super-tack polyester, 1.00 inch wide x 0.50 inch high, 3-inch core.	1.00	25.4	0.50	12.7	10000	40000
C125X030YPT	White, adhesive polyester label, Mini-Com® 2-port identifier. Application codes: BX, FP, and PP.	1.25	31.8	0.30	7.6	2500	10000
C138X019YPT	White, adhesive polyester label, Mini-Com® module identifier. Application code: JM.	1.38	35.1	0.19	4.8	2500	10000
C138X019Y0T	Black, adhesive polyester label, Mini-Com® module identifier. Application code: JM.	1.38	35.1	0.19	4.8	2500	10000
C150X030Y1T	White, non-adhesive polyester label, Mini-Com® 3-port identifier. Application code: FP.	1.50	38.1	0.30	7.6	1000	5000
C188X030YPT	White, adhesive polyester label, Mini-Com® 3-port identifier. Application code: FP.	1.88	47.8	0.30	7.6	2500	10000
C195X040Y1T	White, non-adhesive polyester label.	1.95	49.5	0.40	10.2	1000	10000
C200X100YPT	White, adhesive polyester label, SLCT bundle marker identifier. Application code: SL and RK.	2.00	50.8	1.00	25.4	2500	10000
C200X100Y0T	Black, adhesive polyester label, SLCT bundle marker identifier. Application code: SL and RK.	2.00	50.8	1.00	25.4	2500	10000
C252X030YPT	White, adhesive polyester label, Mini-Com® 4-port identifier. Application codes: BX, FP, and PP.	2.52	64.0	0.30	7.6	2500	10000
C252X030YPT-P*	White, adhesive polyester label, Mini-Com® perforated port identifier. Application codes: BX, FP, and PP.	2.52	64.0	0.30	7.6	2500	10000
C252X030YQT-P*	Blue, adhesive polyester label, Mini-Com® perforated port identifier. Application codes: BX, FP, and PP.	2.52	64.0	0.30	7.6	2500	10000
C252X030YRT-P*	Brown, adhesive polyester label, Mini-Com® perforated port identifier. Application codes: BX, FP, and PP.	2.52	64.0	0.30	7.6	2500	10000
C252X030YST-P*	Green, adhesive polyester label, Mini-Com® perforated port identifier. Application codes: BX, FP, and PP.	2.52	64.0	0.30	7.6	2500	10000
C252X030YTT-P*	Gray, adhesive polyester label, Mini-Com® perforated port identifier. Application codes: BX, FP, and PP.	2.52	64.0	0.30	7.6	2500	10000
C252X030YUT-P*	Orange, adhesive polyester label, Mini-Com® perforated port identifier. Application codes: BX, FP, and PP.	2.52	64.0	0.30	7.6	2500	10000
C252X030YVT-P*	Purple, adhesive polyester label, Mini-Com® perforated port identifier. Application codes: BX, FP, and PP.	2.52	64.0	0.30	7.6	2500	10000
C252X030YWT-P*	Red, adhesive polyester label, Mini-Com® perforated port identifier. Application codes: BX, FP, and PP.	2.52	64.0	0.30	7.6	2500	10000
C252X030Y0T-P*	Black, adhesive polyester label, Mini-Com® perforated port identifier. Application codes: BX, FP, and PP.	2.52	64.1	0.30	7.6	2500	10000
C252X030Y8T-P*	Yellow, adhesive polyester label, Mini-Com® perforated port identifier. Application codes: BX, FP, and PP.	2.52	64.0	0.30	7.6	2500	10000
C252X030Y9T-P*	Gold, adhesive polyester label, Mini-Com® perforated port identifier. Application codes: BX, FP, and PP.	2.52	64.0	0.30	7.6	2500	10000

*Label is perforated to be used in 1, 2, 3, or 4-position applications.

‡Label is perforated to be used in 1, 2, 3, or 4-position applications.

Order number of pieces required, in multiples of Standard Package Quantity.

Labels roll mounted on 3.00" cores; when using the TDP43ME printer and 3.00" cores, the roll stand (TDP43ME-RS) is required.

Thermal Transfer Component Labels (continued)

Part Number	Part Description	Width		Height		Std. Pkg. Qty.	Std. Ctn. Qty.
		In.	mm	In.	mm		
C261X030YPT	White, adhesive polyester label, Mini-Com® 4-port identifier. Application codes: FP and PP.	2.61	66.3	0.30	7.6	2500	10000
C261X035Y1T	White, non-adhesive polyester label, Mini-Com® 4-port identifier. Application codes: FP and PP.	2.61	66.3	0.35	8.9	1000	5000
C275X125YPT	White, adhesive polyester label, general identifier. Application code: RK.	2.75	69.9	1.25	31.8	2500	10000
C275X125Y0T	Black, adhesive polyester label, general identifier. Application code: RK.	2.75	69.9	1.25	31.8	2500	10000
C288X030YPT	White, adhesive polyester label, double gang faceplate identifier. Application code: FP.	2.88	73.2	0.30	7.6	2500	2500
C288X040Y1T	White, non-adhesive polyester label, Mini-Com® double-gang faceplate. Application code: FP.	2.88	73.2	0.40	10.2	1000	1000
C300X100YJT	White, polyester label.	3.00	76.2	1.00	25.4	2500	2500
C315X030YPT	White, adhesive polyester label, Mini-Com® 5-port identifier. Application code: FP.	3.15	80.0	0.30	7.6	2500	2500
C379X030YPT	White, adhesive polyester label, Mini-Com® 6-port identifier. Application code: FP.	3.79	96.3	0.30	7.6	2500	10000
C379X030YPT-P‡	White, adhesive polyester label, Mini-Com® perforated port identifier. Application codes: BX, FP, and PP.	3.79	96.3	0.30	7.6	2500	10000
C379X030YQT-P‡	Blue, adhesive polyester label, Mini-Com® perforated port identifier. Application codes: BX, FP, and PP.	3.79	96.3	0.30	7.6	2500	10000
C379X030YRT-P‡	Brown, adhesive polyester label, Mini-Com® perforated port identifier. Application codes: BX, FP, and PP.	3.79	96.3	0.30	7.6	2500	10000
C379X030YST-P‡	Green, adhesive polyester label, Mini-Com® perforated port identifier. Application codes: BX, FP, and PP.	3.79	96.3	0.30	7.6	2500	10000
C379X030YTT-P‡	Gray, adhesive polyester label, Mini-Com® perforated port identifier. Application codes: BX, FP, and PP.	3.79	96.3	0.30	7.6	2500	10000
C379X030YUT-P‡	Orange, adhesive polyester label, Mini-Com® perforated port identifier. Application codes: BX, FP, and PP.	3.79	96.3	0.30	7.6	2500	10000
C379X030YVT-P‡	Purple, adhesive polyester label, Mini-Com® perforated port identifier. Application codes: BX, FP, and PP.	3.79	96.3	0.30	7.6	2500	10000
C379X030YWT-P‡	Red, adhesive polyester label, Mini-Com® perforated port identifier. Application codes: BX, FP, and PP.	3.79	96.3	0.30	7.6	2500	10000
C379X030Y0T-P‡	Black, adhesive polyester label, Mini-Com® perforated port identifier. Application codes: BX, FP, and PP.	3.79	96.3	0.30	7.6	2500	10000
C379X030Y8T-P‡	Yellow, adhesive polyester label, Mini-Com® perforated port identifier. Application codes: BX, FP, and PP.	3.79	96.3	0.30	7.6	2500	10000
C379X030Y9T-P‡	Gold, adhesive polyester label, Mini-Com® perforated port identifier. Application codes: BX, FP, and PP.	3.79	96.3	0.30	7.6	2500	10000
C390X030Y1T	White, non-adhesive polyester label, Mini-Com® 6-port identifier. Application code: PP.	3.90	99.1	0.30	7.6	1000	5000
C400X100YJT	White, polyester label.	4.00	101.6	1.00	25.4	2500	10000
C400X200YJT	White, polyester label.	4.00	101.6	2.00	50.8	1000	4000
C750X050Y1T	White, non-adhesive polyester label, 110 block identifier. Application code: PB.	7.50	190.5	0.50	12.7	1000	5000
C788X050Y1T	White, non-adhesive polyester label, GP6 System identifier. Application code: GP.	7.88	200.2	0.50	12.7	1000	5000

*Label is perforated to be used in 1, 2, 3, or 4-position applications.

‡Label is perforated to be used in 1, 2, 3, or 4-position applications.

Order number of pieces required, in multiples of Standard Package Quantity.

Labels roll mounted on 3.00" cores; when using the TDP43ME printer and 3.00" cores, the roll stand (TDP43ME-RS) is required.

Thermal Transfer Self-Laminating Labels



- Self-laminating labels supplied on rolls, include a colored print-on area and clear overlaminates to protect the legend for clear and durable identification

- Use with Panduit thermal transfer hybrid ribbons

Part Number	Part Description	Width		Length		Print-On Area Height		Min. Cable O.D.		Max. Cable O.D.		Std. Pkg. Qty.	Std. Ctn. Qty.
		In.	mm	In.	mm	In.	mm	In.	mm	In.	mm		
S050X075VATY*	White print-on area, vinyl label for 18 – 14 AWG wires.	0.50	12.7	0.75	19.1	0.25	6.4	0.08	2.0	0.16	4.0	5000	40000
S050X125VATY*	White print-on area, vinyl label for 12 – 10 AWG wires, Cat. 3 UTP cable.	0.50	12.7	1.25	31.8	0.38	9.7	0.12	3.1	0.28	7.0	5000	10000
S050X150VATY*	White print-on area, vinyl label for Cat. 5e/Cat. 6/Cat. 6A UTP/Cat. 5e FTP cable.	0.50	12.7	1.50	38.1	0.50	12.7	0.16	4.0	0.32	8.1	5000	40000
S050X250VATY	White print-on area, vinyl label for 6 – 2 AWG wires.	0.50	12.7	2.50	63.5	1.00	25.4	0.32	8.1	0.95	24.3	5000	20000
S075X075VATY	White print-on area, vinyl label for 18 – 14 AWG wires.	0.75	19.1	0.75	19.1	0.25	6.4	0.08	2.0	0.16	4.0	5000	20000
S075X125VATY	White print-on area, vinyl label for 12 – 10 AWG wires, Cat. 3 UTP cable.	0.75	19.1	1.25	31.8	0.38	9.7	0.12	3.1	0.28	7.0	5000	20000
S075X150VATY	White print-on area, vinyl label for Cat. 5e/Cat. 6/Cat. 6A UTP/Cat. 5e FTP cable.	0.75	19.1	1.50	38.1	0.50	12.7	0.16	4.0	0.32	8.1	5000	20000
S100X075VATY*	White print-on area, vinyl label for 18 – 14 AWG wires.	1.00	25.4	0.75	19.1	0.25	6.4	0.08	2.0	0.16	4.0	5000	10000
S100X125VATY*	White print-on area, vinyl label for 12 – 10 AWG wires, Cat. 3 UTP cable.	1.00	25.4	1.25	31.8	0.38	9.7	0.12	3.1	0.28	7.0	5000	10000
S100X150VATY*	White print-on area, vinyl label for Cat. 5e/Cat. 6/Cat. 6A UTP/Cat. 5e FTP cable.	1.00	25.4	1.50	38.1	0.50	12.7	0.16	4.0	0.32	8.1	5000	20000
S100X150VBTY	Blue print-on area, vinyl label for Cat. 5e/Cat. 6/Cat. 6A UTP/Cat. 5e FTP cable.	1.00	25.4	1.50	38.1	0.50	12.7	0.16	4.0	0.32	8.1	5000	20000
S100X150VCTY	Brown print-on area, vinyl label for Cat. 5e/Cat. 6/Cat. 6A UTP/Cat. 5e FTP cable.	1.00	25.4	1.50	38.1	0.50	12.7	0.16	4.0	0.32	8.1	5000	20000
S100X150VDTY	Green print-on area, vinyl label for Cat. 5e/Cat. 6/Cat. 6A UTP/Cat. 5e FTP cable.	1.00	25.4	1.50	38.1	0.50	12.7	0.16	4.0	0.32	8.1	5000	20000
S100X150VETY	Gray print-on area, vinyl label for Cat. 5e/Cat. 6/Cat. 6A UTP/Cat. 5e FTP cable.	1.00	25.4	1.50	38.1	0.50	12.7	0.16	4.0	0.32	8.1	5000	20000
S100X150VFTY	Orange print-on area, vinyl label for Cat. 5e/Cat. 6/Cat. 6A UTP/Cat. 5e FTP cable.	1.00	25.4	1.50	38.1	0.50	12.7	0.16	4.0	0.32	8.1	5000	20000
S100X150VGTY	Purple print-on area, vinyl label for Cat. 5e/Cat. 6/Cat. 6A UTP/Cat. 5e FTP cable.	1.00	25.4	1.50	38.1	0.50	12.7	0.16	4.0	0.32	8.1	5000	20000
S100X150VHTY	Red print-on area, vinyl label for Cat. 5e/Cat. 6/Cat. 6A UTP/Cat. 5e FTP cable.	1.00	25.4	1.50	38.1	0.50	12.7	0.16	4.0	0.32	8.1	5000	20000
S100X150VITY	Yellow print-on area, vinyl label for Cat. 5e/Cat. 6/Cat. 6A UTP/Cat. 5e FTP cable.	1.00	25.4	1.50	38.1	0.50	12.7	0.16	4.0	0.32	8.1	5000	20000
S100X150V0TY	Black print-on area, vinyl label for Cat. 5e/Cat. 6/Cat. 6A UTP/Cat. 5e FTP cable.	1.00	25.4	1.50	38.1	0.50	12.7	0.16	4.0	0.32	8.1	5000	20000

Order number of labels required, in multiples of Standard Package Quantity.

Labels are roll mounted on 3.00" cores; when using the TDP43ME printer and 3.00" cores, the roll stand (TDP43ME-RS) is required.

*For labels mounted on 1.00" cores, replace suffix TY with 1Y.

Thermal Transfer Self-Laminating Labels (continued)

Part Number	Part Description	Width		Length		Print-On Area Height		Min. Cable O.D.		Max. Cable O.D.		Std. Pkg. Qty.	Std. Ctn. Qty.
		In.	mm	In.	mm	In.	mm	In.	mm	In.	mm		
S100X150V9TY	Gold print-on area, vinyl label for Cat. 5e/Cat. 6/Cat. 6A UTP/Cat. 5e FTP cable.	1.00	25.4	1.50	38.1	0.50	12.7	0.16	4.0	0.32	8.1	5000	20000
S100X225VATY*	White print-on area, vinyl label for 8 – 4 AWG wires, Cat. 6A UTP, FTP/Cat. 6 FTP cable.	1.00	25.4	2.25	57.2	0.75	19.1	0.24	6.1	0.48	12.1	5000	20000
S100X225VBTY	Blue print-on area, vinyl label for 8 – 4 AWG wires, Cat. 6A UTP, FTP/Cat. 6 FTP cable.	1.00	25.4	2.25	57.2	0.75	19.1	0.24	6.1	0.48	12.1	5000	20000
S100X225VCTY	Brown print-on area, vinyl label for 8 – 4 AWG wires, Cat. 6A UTP, FTP/Cat. 6 FTP cable.	1.00	25.4	2.25	57.2	0.75	19.1	0.24	6.1	0.48	12.1	5000	20000
S100X225VDTY	Green print-on area, vinyl label for 8 – 4 AWG wires, Cat. 6A UTP, FTP/Cat. 6 FTP cable.	1.00	25.4	2.25	57.2	0.75	19.1	0.24	6.1	0.48	12.1	5000	20000
S100X225VETY	Gray print-on area, vinyl label for 8 – 4 AWG wires, Cat. 6A UTP, FTP/Cat. 6 FTP cable.	1.00	25.4	2.25	57.2	0.75	19.1	0.24	6.1	0.48	12.1	5000	20000
S100X225VFTY	Orange print-on area, vinyl label for 8 – 4 AWG wires, Cat. 6A UTP, FTP/Cat. 6 FTP cable.	1.00	25.4	2.25	57.2	0.75	19.1	0.24	6.1	0.48	12.1	5000	20000
S100X225VGTY	Purple print-on area, vinyl label for 8 – 4 AWG wires, Cat. 6A UTP, FTP/Cat. 6 FTP cable.	1.00	25.4	2.25	57.2	0.75	19.1	0.24	6.1	0.48	12.1	5000	20000
S100X225VHTY	Red print-on area, vinyl label for 8 – 4 AWG wires, Cat. 6A UTP, FTP/Cat. 6 FTP cable.	1.00	25.4	2.25	57.2	0.75	19.1	0.24	6.1	0.48	12.1	5000	20000
S100X225VITY	Yellow print-on area, vinyl label for 8 – 4 AWG wires, Cat. 6A UTP, FTP/Cat. 6 FTP cable.	1.00	25.4	2.25	57.2	0.75	19.1	0.24	6.1	0.48	12.1	5000	20000
S100X225V0TY	Black print-on area, vinyl label for 8 – 4 AWG wires, Cat. 6A UTP, FTP/Cat. 6 FTP cable.	1.00	25.4	2.25	57.2	0.75	19.1	0.24	6.1	0.48	12.1	5000	20000
S100X225V9TY	Gold print-on area, vinyl label for 8 – 4 AWG wires, Cat. 6A UTP, FTP/Cat. 6 FTP cable.	1.00	25.4	2.25	57.2	0.75	19.1	0.24	6.1	0.48	12.1	5000	20000
S100X250VATY*	White print-on area, vinyl label for 6 – 2 AWG wires.	1.00	25.4	2.50	63.5	1.00	25.4	0.32	8.1	0.48	12.1	5000	20000
S100X400VATY*	White print-on area, vinyl label for 6 – 2 AWG wires.	1.00	25.4	2.50	63.5	1.00	25.4	0.32	8.1	0.95	12.1	5000	20000
S100X650VATY*	White print-on area, vinyl label for 1/0 – 250 MCM wires.	1.00	25.4	6.50	165.1	1.50	38.1	0.48	12.1	1.59	40.4	1000	2000
S150X150VATY	White print-on area, vinyl label for Cat. 5e/Cat. 6/Cat. 6A UTP/Cat. 5e FTP cable.	1.50	38.1	1.50	38.1	0.50	12.7	0.16	4.0	0.32	8.1	5000	20000
S150X225VATY	White print-on area, vinyl label for 8 – 4 AWG wires, Cat. 6A UTP, FTP/Cat. 6 FTP cable.	1.50	38.1	2.25	57.2	0.75	19.1	0.24	6.1	0.48	12.1	5000	20000
S150X400VATY	White print-on area, vinyl label for 2 – 1 AWG wires.	1.50	38.1	4.00	101.6	1.00	25.4	0.32	8.1	0.95	24.1	2500	10000
S200X150VATY	White print-on area, vinyl label for Cat. 5e/Cat. 6/Cat. 6A UTP/Cat. 5e FTP cable.	2.00	50.8	1.50	38.1	0.50	12.7	0.16	4.0	0.32	8.1	5000	20000
S200X225VATY*	White print-on area, vinyl label for 6 – 2 AWG wires.	2.00	50.8	2.50	63.5	1.00	25.4	0.24	6.1	0.48	12.1	1000	4000
S200X250VATY	White print-on area, vinyl label for 6 – 2 AWG wires.	2.00	50.8	2.50	63.5	1.00	25.4	0.32	8.1	0.48	12.1	1000	4000
S200X400VATY*	White print-on area, vinyl label for 2 – 1 AWG wires.	2.00	50.8	4.00	101.6	1.00	25.4	0.32	8.1	0.95	24.1	1000	3000
S200X650VATY*	White print-on area, vinyl label for 1/0 – 250 MCM wires.	2.00	50.8	6.50	165.1	1.50	38.1	0.48	12.1	1.59	40.4	1000	2000

Order number of labels required in multiples of Standard Package Quantity.

Labels are roll mounted on 3.00" cores; when using the TDP43ME printer and 3.00" cores, the roll stand (TDP43ME-RS) is required.

* For labels mounted on 1.00" cores, replace suffix TY with 1Y.

LabelCore™ Fiber Optic Cable Identification Sleeves

- Provides a larger surface on small fiber cables and allows legends to be clearly seen
- Sleeves are made of flexible PVC material
Locate sleeve on straight section of cable at least 2 inches from fiber boot

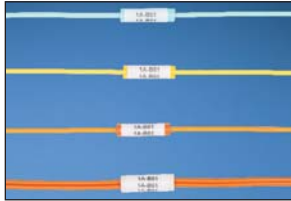

Part Number	Part Description	Std. Pkg. Qty.*	Std. Ctn. Qty.
NWSLC-2Y	Yellow cable identification sleeve for 2mm simplex fiber cable, 1 inch long, 100 per pack use with labels: S100X160YAJ or S100X150YAJ (Laser/Inkjet), S100X160VAC or S100X150VAC (LS8E Hand-held Printer), S100X150VA1Y or S100X150VATY (Thermal Transfer Printer).	100	1000
NWSLC-2Y-AQ	Aqua cable identification sleeve for 2mm simplex cable, 1 inch long, 100 per pack, use with labels: S100X160YAJ or S100X150YAJ (Laser/Inkjet); S100X160VAC or S100X150VAC (LS8E Hand-held Printer); S100X150VA1Y or S100X150VATY (Thermal Transfer Printer).	100	1000
NWSLC-3Y	Orange cable identification sleeve for 3mm simplex cable, 1 inch long, 100 per pack, use with labels: S100X160YAJ or S100X150YAJ (Laser/Inkjet); S100X160VAC or S100X150VAC (LS8E Hand-held Printer); S100X150VA1Y or S100X150VATY (Thermal Transfer Printer).	100	1000
NWSLC-7Y	White cable identification sleeve for 3mm duplex fiber cable, 1 inch long, 100 per pack, use with labels: S100X225YAJ (Laser/Inkjet); S100X225VAC (LS8E Hand-held Printer); S100X225VA1Y or S100X225VATY (Thermal Transfer Printer).	100	1000
NWSLC2-2Y	Yellow cable identification sleeve for 2mm simplex cable, 2 inches long, 100 per pack, use with labels: S200X150YAJ (Laser/Inkjet) or S200X150VATY (Thermal Transfer Printer).	100	1000
NWSLC2-2Y-AQ	Aqua cable identification sleeve for 2mm simplex cable, 2 inches long, 100 per pack, use with labels: S200X150YAJ (Laser/Inkjet) or S200X150VATY (Thermal Transfer Printer).	100	1000
NWSLC2-3Y	Orange cable identification sleeve for 3mm simplex cable, 2 inches long, 100 per pack, use with labels: S200X150YAJ (Laser/Inkjet) or S200X150VATY (Thermal Transfer Printer).	100	1000
NWSLC2-7Y	White cable identification sleeve for 3mm duplex fiber cable, 2 inches long, 100 per pack, use with labels: S200X225YAJ (Laser/Inkjet); S100X225VA1Y or S100X225VATY (Thermal Transfer Printer).	100	1000

Order number of labels required, in multiples of Standard Package Quantity.

Self-Laminating Labels for use with LabelCore™ Fiber Optic Cable Identification System

Part Number	Description	Width		Length		Print-On Area Height		Min. Cable O.D.		Max. Cable O.D.		Labels Per Row	Std. Pkg. Qty.
		In.	mm	In.	mm	In.	mm	In.	mm	In.	mm		
S100X150VATY	White print-on area, vinyl label for Cat. 5e/Cat. 6/Cat. 6A UTP/Cat. 5e FTP cable.	1.00	25.4	1.50	38.1	0.50	12.7	0.16	4.0	0.32	8.1	4	5000
S100X225VATY	White print-on area, vinyl label for 8 – 4 AWG wires, Cat. 6A UTP, FTP/Cat. 6 FTP cable.	1.00	25.4	2.25	57.2	0.75	19.1	0.24	6.1	0.48	12.1	4	5000
S200X150VATY	White print-on area, vinyl label for Cat. 5e/Cat. 6/Cat. 6A UTP/Cat. 5e FTP cable.	2.00	50.8	1.50	38.1	0.50	12.7	0.16	4.0	0.32	8.1	2	5000
S200X225VATY	White print-on area, vinyl label for 8 – 4 AWG wire, for Cat.6A UTP, FTP/Cat. 6 FTP cable.	2.00	50.8	2.25	57.2	0.75	19.1	0.24	6.1	0.48	12.1	2	1000

Turn-Tell® Labels

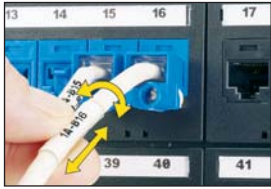

- Allows labels to rotate for visibility from any angle, and allows repositioning on the wire/cable to align legends for improved aesthetics
- Ideal for use in high-density or space-constrained cable applications
- Use thermal transfer hybrid ribbon
- Temperature range: -40°F to 200°F (-40°C to 107°C)

Part Number	Part Description	Width		Length		Print-On Area Height		Min. Cable O.D.		Max. Wire O.D.		Std. Pkg. Qty.	Std. Ctn. Qty.
		In.	mm	In.	mm	In.	mm	In.	mm	In.	mm		
R050X075V1T	Thermal Transfer, Vinyl, 0.50" W x 0.75" H, 0.25" POA, Clear/White, 3" Core, 18 – 14 AWG wire/cable.	0.50	12.7	0.75	19.1	0.25	6.4	0.12	3.1	0.16	4.1	5000	20000
R050X125V1T	Thermal Transfer, Vinyl, 0.50" W x 1.25" H, 0.38" POA, Clear/White, 3" Core, 12 – 10 AWG wire/cable, Cat. 3 UTP cable.	0.50	12.7	1.25	31.8	0.38	9.7	0.12	3.1	0.16	4.1	5000	20000
R050X150V1T	Thermal Transfer, Vinyl, 0.50" W x 1.50" H, 0.50" POA, Clear/White, 3" Core, 10 – 6 AWG wire/cable, Cat. 5e/6/6e UTP and Cat. 5e FTP cable.	0.50	12.7	1.50	38.1	0.50	12.7	0.16	4.0	0.32	8.1	5000	20000
R100X075V1T	Thermal Transfer, Vinyl, 1.00" W x 0.75" H, 0.25" POA, Clear/White, 3" Core, 18 – 14 AWG wire/cable.	1.00	25.4	0.75	19.1	0.25	6.4	0.12	3.1	0.16	4.1	2500	10000
R100X125V1T	Thermal Transfer, Vinyl, 1.00" W x 1.25" H, 0.38" POA, Clear/White, 3" Core, 12 – 10 AWG wire/cable, Cat. 3 UTP cable.	1.00	25.4	1.25	31.8	0.38	9.7	0.16	4.1	0.22	5.6	2500	10000
R100X150V1T	Thermal Transfer, Vinyl, 1.00" W x 1.50" H, 0.50" POA, Clear/White, 3" Core, Cat. 5e/6/6A UTP/Cat. 5e FTP cable.	1.00	25.4	1.50	38.1	0.50	12.7	0.22	5.6	0.28	7.1	2500	10000
R100X150V2T	Thermal Transfer, Vinyl, 1.00" W x 1.50" H, 0.50" POA, Clear/Blue, 3" Core, Cat. 5e/6/6A UTP/Cat. 5e FTP cable.	1.00	25.4	1.50	38.1	0.50	12.7	0.22	5.6	0.28	7.1	2500	10000
R100X150V3T	Thermal Transfer, Vinyl, 1.00" W x 1.50" H, 0.50" POA, Clear/Green, 3" Core, Cat. 5e/6/6A UTP/Cat. 5e FTP cable.	1.00	25.4	1.50	38.1	0.50	12.7	0.22	5.6	0.28	7.1	2500	10000
R100X150V7T	Thermal Transfer, Vinyl, 1.00" W x 1.50" H, 0.50" POA, Clear/Red, 3" Core, Cat. 5e/6/6A UTP/Cat. 5e FTP cable.	1.00	25.4	1.50	38.1	0.50	12.7	0.22	5.6	0.28	7.1	2500	10000
R100X150V8T	Thermal Transfer, Vinyl, 1.00" W x 1.50" H, 0.50" POA, Clear/Yellow, 3" Core, Cat. 5e/6/6A UTP/Cat. 5e FTP cable.	1.00	25.4	1.50	38.1	0.50	12.7	0.22	5.6	0.28	7.1	2500	10000
R100X225V1T	Thermal Transfer Vinyl, 1.00" W x 2.25" H, 0.75" POA, Clear/White, 3" Core, 8 – 4 AWG wire/cable, Cat. 6A UTP, FTP/Cat. 6 FTP cable.	1.00	25.4	2.25	57.2	0.75	19.1	0.28	7.1	0.39	9.9	2500	10000
R100X225V2T	Thermal Transfer, Vinyl, 1.00" W x 2.25" H, 0.75" POA, Clear/Blue, 3" Core, 8 – 4 AWG wire/cable, Cat. 6A UTP, FTP/Cat. 6 FTP cable.	1.00	25.4	2.25	57.2	0.75	19.1	0.28	7.1	0.39	9.9	2500	10000
R100X225V3T	Thermal Transfer, Vinyl, 1.00" W x 2.25" H, 0.75" POA, Clear/Green, 3" Core, 8 – 4 AWG wire/cable, Cat. 6A UTP, FTP/Cat. 6 FTP cable.	1.00	25.4	2.25	57.2	0.75	19.1	0.28	7.1	0.39	9.9	2500	10000
R100X225V7T	Thermal Transfer, Vinyl, 1.00" W x 2.25" H, 0.75" POA, Clear/Red, 3" Core, 8 – 4 AWG wire/cable, Cat. 6A UTP, FTP/Cat. 6 FTP cable.	1.00	25.4	2.25	57.2	0.75	19.1	0.28	7.1	0.39	9.9	2500	10000
R100X225V8T	Thermal Transfer, Vinyl, 1.00" W x 2.25" H, 0.75" POA, Clear/Yellow, 3" Core, 8 – 4 AWG wire/cable, Cat. 6A UTP, FTP/Cat. 6 FTP cable.	1.00	25.4	2.25	57.2	0.75	19.1	0.28	7.1	0.39	9.9	2500	10000

Order number of labels required, in multiples of Standard Package Quantity.

Table continues on page O.20

- A. System Overview
- B. Copper Systems
- C. Fiber Optic Systems
- D. Power over Ethernet
- E. Zone Cabling
- F. Wireless
- G. Outlets
- H. Media Distribution
- I. Physical Infrastructure Management
- J. Overhead & Underfloor Routing
- K. Surface Raceway
- L. Cabinets, Racks & Cable Management
- M. Grounding & Bonding
- N. Industrial
- O. Labeling & Identification
- P. Cable Management Accessories
- Q. Index

Turn-Tell[®] Labels (continued)

Part Number	Part Description	Width		Length		Print-On Area Height		Min. Cable O.D.		Max. Wire O.D.		Std. Pkg. Qty.	Std. Ctn. Qty.
		In.	mm	In.	mm	In.	mm	In.	mm	In.	mm		
R100X400V1T	Thermal Transfer, Vinyl, 1.00" W x 4.00" H, 1.00" POA, Clear/White, 3" Core, 2 AWG – 250 MCM wire/cable.	1.00	25.4	4.00	101.6	1.00	25.4	0.39	9.9	0.95	24.1	1000	4000
R200X150V1T	Thermal Transfer, Vinyl, 2.00" W x 1.50" H, 0.50" POA, Clear/White, 3" Core, Cat. 5e/6/6A UTP/Cat. 5e FTP cable.5/5e/6 cable.	2.00	50.8	1.50	38.1	0.50	12.7	0.22	5.6	0.28	7.1	1000	4000
R200X225V1T	Thermal Transfer, Vinyl, 2.00" W x 2.25" H, 0.75" POA, Clear/White, 3" Core, 8 – 4 AWG wire/cable, Cat. 6A UTP, FTP/Cat. 6 FTP cable.	2.00	50.8	2.25	57.2	0.75	19.1	0.28	7.1	0.39	9.9	1000	4000
R200X400V1T	Thermal Transfer, Vinyl, 2.00" W x 4.00" H, 1.00" POA, Clear/White, 3" Core, 2 AWG – 250 MCM wire/cable.	2.00	50.8	4.00	101.6	1.00	25.4	0.39	9.9	0.95	24.1	1000	4000

Order number of labels required in multiples of Standard Package Quantity.

Thermal Transfer Marker Plates

- Non-adhesive halogen-free marker plates used to identify wires, cables, equipment, and many other applications
- Offers crisp, clear legend with superior legibility and engineered to withstand high temperatures, harsh solvents, oils, and chemicals without over-lamination
- Attachable in horizontal or vertical orientation
- Available in a variety of colors and sizes
- Temperature range: -58°F to 221°F (-50°C to 105°C)
- Use with Panduit thermal transfer resin ribbons

Part Number	Color							Width In. (mm)	Height In. (mm)	Print-On Area Width In. (mm)	Labels Per Roll	Std. Pkg. Qty.
	Yellow	White	Blue	Green	Gray	Orange	Red					
M200X050*	Y6T	Y7T	ACT	AET	AFT	AGT	AIT	2.00 (50.8)	0.50 (12.7)	1.07 (27.2)	500	1 Roll
M200X100*	Y6T	Y7T	ACT	AET	AFT	AGT	AIT	2.00 (50.8)	1.00 (25.4)	0.80 (20.3)	500	1 Roll
M300X050*	Y6T	Y7T	ACT	AET	AFT	AGT	AIT	3.00 (76.2)	0.50 (12.7)	2.07 (52.6)	500	1 Roll
M300X100*	Y6T	Y7T	ACT	AET	AFT	AGT	AIT	3.00 (76.2)	1.00 (25.4)	1.80 (45.7)	500	1 Roll

Replace the asterisk in part numbers above with the desired color code.

Thermal Transfer Flag Labels

- Halogen-free, polyester flag-style marker for wire/cable labeling
- Improved legibility and more information on small wires and cables provide clearer, more complete identification
- Innovative design allows the product to be applied as a permanent adhesive label or as a repositionable non-adhesive label
- Temperature range: -40°F to 302°F (-40°C to 150°C)
- UL969 recognized, File # MH14576 and File # MH14979; cUL recognized C22.2 No 0.15-01, File # MH14979
- Use with Panduit thermal transfer resin ribbons

Part Number	Color	Width		Height		Min. Cable O.D.		Max. Cable O.D.		Wire Range	Std. Pkg. Qty.	Std. Ctn. Qty.
		In.	mm	In.	mm	In.	mm	In.	mm			
F100X150AJT	White	1.00	25.4	1.50	38.1	0.12	3.1	0.20	5.1	12 – 10 AWG	2500	10000
F100X213AJT	White	1.00	25.4	2.13	54.1	0.32	8.1	0.38	9.7	3 – 2 AWG	2500	10000
F100X300AJT	White	1.00	25.4	3.00	76.2	0.90	2.3	0.28	7.1	8 – 4 AWG	2500	10000
F100X363AJT	White	1.00	25.4	3.63	92.2	0.20	5.1	0.46	11.7	2 – 1 AWG	2500	10000

Thermal Transfer Raised Panel Labels



- Raised thermal transfer printable surface with high-tack adhesive for strong holding power
- Variety of sizes and colors for a wide range of applications
- Thermal transfer print technology provides crisp, clear, and durable text
- Use with Panduit thermal transfer resin ribbons

Part Number	Part Description	Width		Height		Std. Pkg. Qty.	Std. Ctn. Qty.
		In.	mm	In.	mm		
C100X050APT	White, raised panel component label.	1.00	25.4	0.50	12.7	500	2000
C100X050A0T	Black, raised panel component label.	1.00	25.4	0.50	12.7	500	2000
C200X100APT	White, raised panel component label.	2.00	50.8	1.00	25.4	500	2000
C200X100A0T	Black, raised panel component label.	2.00	50.8	1.00	25.4	500	2000
C300X100APT	White, raised panel component label.	3.00	76.2	1.00	25.4	500	2000
C300X100A0T	Black, raised panel component label.	3.00	76.2	1.00	25.4	500	2000
C400X100APT	White, raised panel component label.	4.00	101.6	1.00	25.4	500	2000
C400X100A0T	Black, raised panel component label.	4.00	101.6	1.00	25.4	500	2000
C252X030APT	White, raised panel component label.	2.52	64.0	0.30	7.6	500	2000
C252X030A0T	Black, raised panel component label.	2.52	64.0	0.30	7.6	500	2000
C379X030APT	White, raised panel component label.	3.79	96.3	0.30	7.6	500	2000
C379X030A0T	Black, raised panel component label.	3.79	96.3	0.30	7.6	500	2000

Ultimate ID® Network System Laser/Ink Jet Labels



- Ultimate ID® Network Labeling Software is included at no charge with each package of laser/ink jet labels
- Labels can be printed in both laser and ink jet printers
- Designed to efficiently support TIA/EIA-606-B standard labeling requirements
- Laser and ink jet labels for use with Ultimate ID™ Faceplates, Patch Panels, Marker Ties, Modular Furniture Faceplate, and Surface Mount Boxes
- Durable multi-layer construction
- Non-adhesive labels are easily removed from 8.5" x 11" label sheets
- Unique non-adhesive material configuration
- Ultimate ID™ Labels are part of a complete system for identification designed to efficiently support TIA/EIA-606-B standard labeling requirements



Part Number	Part Description	Width		Height		Std. Pkg. Qty.	Std. Ctn. Qty.
		In.	mm	In.	mm		
UILJ1	White, non-adhesive polyester labels, 264 per sheet, 1-port labels.	0.68	17.3	0.24	6.0	5	50
UILJ2	White, non-adhesive polyester labels, 132 per sheet, 2-port labels.	1.32	33.4	0.24	6.0	5	50
UILJ3	White, non-adhesive polyester labels, 99 per sheet, 3-port labels.	1.95	49.5	0.24	6.0	5	50
UILJ4	White, non-adhesive polyester labels, 66 per sheet, 4-port labels.	2.59	65.7	0.24	6.0	5	50
UILJ6	White, non-adhesive polyester labels, 66 per sheet, 6-port labels.	3.86	97.9	0.24	6.0	5	50
UILJCOMBO	White, non-adhesive polyester labels, combination sheet with forty 1-port, sixty 2-port, three 3-port and twenty-four 4-port labels.	—	—	0.24	6.0	5	50

For Electrical Ivory labels, add EI to end of part number.
Order number of sheets required in multiples of Standard Package Quantity.

Table continues on page O.22

Laser/Ink Jet Component Labels



- Labels can be printed in both laser and ink jet printers
- Use for identifying patch panels, faceplates, punchdown blocks and other network systems hardware
- Die-cut labels designed to provide maximum aesthetic quality and appearance
- Available in adhesive polyolefin and non-adhesive polyester materials

<i>Application Description</i>	<i>Typical Application Page</i>	<i>Code</i>
Boxes – Surface Mount, Outlet, Hybrid	G.23 – G.24	BX
Faceplates	G.2	FP
GP6™ Category 6 Punchdown Blocks	B.76	GP
Jack Modules	B.76	JM

<i>Application Description</i>	<i>Typical Application Page</i>	<i>Code</i>
Punchdown Blocks – 110	B.84	PB
Patch Panels	B.30 – 31	PP
Racks and Cabinets	L.20	RK
Cable Marker Holder – SLCT	B.95	SL

Part Number	Part Description	Width		Height		Std. Pkg. Qty.	Std. Ctn. Qty.
		In.	mm	In.	mm		
C061X030FJJ	White, adhesive polyolefin label, Mini-Com® 1-port identifier. Application codes: BX, FP, and PP.	0.61	15.5	0.30	7.6	5000	25000
C125X030FJJ	White, adhesive polyolefin label, Mini-Com® 2-port identifier. Application codes: BX, FP, and PP.	1.25	31.8	0.30	7.6	2500	12500
C138X019FJJ	White, adhesive polyolefin label, Mini-Com® module identifier. Application code: JM.	1.38	35.1	0.19	4.8	2500	12500
C150X030Y1J	White, non-adhesive polyester label, Mini-Com® 3-port identifier. Application code: FP.	1.50	38.1	0.30	7.6	1000	5000
C188X030FJJ	White, adhesive polyolefin label, Mini-Com® 3-port identifier. Application code: FP.	1.88	47.8	0.30	7.6	1000	5000
C195X040Y1J	White, non-adhesive polyester label, single-gang faceplate. Application code: FP.	1.95	49.5	0.40	10.2	1000	5000
C200X100FJJ	White, adhesive polyolefin label, SLCT bundle marker identifier. Application code: SL and RK.	2.00	50.8	1.00	25.4	1000	5000
C252X030FJJ	White, adhesive polyolefin label, Mini-Com® 4-port identifier. Application codes: BX, FP, and PP.	2.52	64.0	0.30	7.6	1000	5000
C252X030FRJ	Brown, non-adhesive polyester label, Mini-Com® 4-port identifier. Application codes: BX, FP, and PP.	2.52	64.0	0.30	7.6	1000	5000
C252X030FTJ	Gray, non-adhesive polyester label, Mini-Com® 4-port identifier. Application codes: BX, FP, and PP.	2.52	64.0	0.30	7.6	1000	5000
C261X030FJJ	White, adhesive polyolefin label, Mini-Com® 4-port identifier. Application codes: FP and PP.	2.61	66.3	0.30	7.6	1000	5000
C261X035Y1J	White, non-adhesive polyester label, Mini-Com® 4-port identifier. Application codes: FP and PP.	2.61	66.3	0.35	8.9	1000	5000
C282X030Y1J	White, non-adhesive polyester label, Mini-Com® 4-port identifier. Application codes: FP and PP.	2.82	71.6	0.30	7.6	1000	5000
C288X040Y1J	White, non-adhesive polyester label, double-gang faceplate. Application code: FP.	2.88	73.2	0.40	10.2	1000	5000
C315X030FJJ	White, adhesive polyolefin label, Mini-Com® 5-port identifier. Application code: FP.	3.15	80.0	0.30	7.6	1000	5000
C379X030FJJ	White, adhesive polyolefin label, Mini-Com® 6-port identifier. Application code: FP.	3.79	96.3	0.30	7.6	1000	5000
C390X030Y1J	White, non-adhesive polyester label, Mini-Com® 6-port identifier. Application code: PP.	3.90	99.1	0.30	7.6	1000	5000
C750X050Y1J	White, non-adhesive polyester label, 110 block identifier. Application code: PB.	7.50	190.5	0.50	12.7	500	2500
C788X050Y1J	White, non-adhesive polyester label, GP6™ System identifier. Application code: GP.	7.88	200.2	0.50	12.7	500	2500

Laser/Ink Jet Self-Laminating Labels



- Labels can be printed in both laser and ink jet printers
- Self-laminating adhesive labels include a colored print-on area and clear overlaminate

Part Number	Part Description	Width		Length		Print-On Area Height		Min. Cable O.D.		Max. Cable O.D.		Std. Pkg. Qty.	Std. Ctn. Qty.
		In.	mm	In.	mm	In.	mm	In.	mm	In.	mm		
S050X075YAJ	White print-on area, polyester label for 18 – 14 AWG wire.	0.50	12.7	0.75	19.1	0.25	6.4	0.08	2.0	0.16	4.1	5000	25000
S050X125YAJ	White print-on area, polyester label for 12 – 10 AWG wire, Cat. 3 UTP cable.	0.50	12.7	1.25	31.8	0.38	9.7	0.12	3.1	0.28	7.0	5000	25000
S050X150YAJ	White print-on area, polyester label for Cat. 5e/Cat. 6/Cat. 6A UTP/Cat. 5e FTP cable.	0.50	12.7	1.50	38.1	0.50	12.7	0.16	4.1	0.32	8.1	5000	25000
S075X075YAJ	White print-on area, polyester label for 18 – 14 AWG wire.	0.75	19.1	0.75	19.1	0.25	6.4	0.08	2.0	0.16	4.1	2500	10000
S075X125YAJ	White print-on area, polyester label for 12 – 10 AWG wire, Cat. 3 UTP cable.	0.75	19.1	1.25	31.8	0.38	9.7	0.12	3.1	0.28	7.0	2500	10000
S075X150YAJ	White print-on area, polyester label for Cat. 5e/Cat. 6/Cat. 6A UTP/Cat. 5e FTP cable.	0.75	19.1	1.50	38.1	0.50	12.7	0.16	4.1	0.32	8.1	2500	10000
S100X075YAJ	White print-on area, polyester label for 18 – 14 AWG wire.	1.00	25.4	0.75	19.1	0.25	6.4	0.08	2.0	0.16	4.1	2500	10000
S100X125YAJ	White print-on area, polyester label for 12 – 10 AWG wire, Cat. 3 UTP cable.	1.00	25.4	1.25	31.8	0.38	9.7	0.12	3.1	0.28	7.0	2500	10000
S100X150YAJ	White print-on area, polyester label for Cat. 5e/Cat. 6/Cat. 6A UTP/Cat. 5e FTP cable.	1.00	25.4	1.50	38.1	0.50	12.7	0.16	4.1	0.32	8.1	2500	10000
S100X150YBJ	Blue print-on area, polyester label for Cat. 5e/Cat. 6/Cat. 6A UTP/Cat. 5e FTP cable.	1.00	25.4	1.50	38.1	0.50	12.7	0.16	4.1	0.32	8.1	2500	10000
S100X150Y CJ	Brown print-on area, polyester label for Cat. 5e/Cat. 6/Cat. 6A UTP/Cat. 5e FTP cable.	1.00	25.4	1.50	38.1	0.50	12.7	0.16	4.1	0.32	8.1	2500	10000
S100X150Y DJ	Green print-on area, polyester label for Cat. 5e/Cat. 6/Cat. 6A UTP/Cat. 5e FTP cable.	1.00	25.4	1.50	38.1	0.50	12.7	0.16	4.1	0.32	8.1	2500	10000
S100X150Y EJ	Gray print-on area, polyester label for Cat. 5e/Cat. 6/Cat. 6A UTP/Cat. 5e FTP cable.	1.00	25.4	1.50	38.1	0.50	12.7	0.16	4.1	0.32	8.1	2500	10000
S100X150Y FJ	Orange print-on area, polyester label for Cat. 5e/Cat. 6/Cat. 6A UTP/Cat. 5e FTP cable.	1.00	25.4	1.50	38.1	0.50	12.7	0.16	4.1	0.32	8.1	2500	10000
S100X150Y GJ	Purple print-on area, polyester label for Cat. 5e/Cat. 6/Cat. 6A UTP/Cat. 5e FTP cable.	1.00	25.4	1.50	38.1	0.50	12.7	0.16	4.1	0.32	8.1	2500	10000
S100X150Y HJ	Red print-on area, polyester label for Cat. 5e/Cat. 6/Cat. 6A UTP/Cat. 5e FTP cable.	1.00	25.4	1.50	38.1	0.50	12.7	0.16	4.1	0.32	8.1	2500	10000
S100X150Y IJ	Yellow print-on area, polyester label for Cat. 5e/Cat. 6/Cat. 6A UTP/Cat. 5e FTP cable.	1.00	25.4	1.50	38.1	0.50	12.7	0.16	4.1	0.32	8.1	2500	10000

Order number of labels required in multiples of Std. Pkg. Qty.

Laser/Ink Jet Self-Laminating Labels (continued)

Part Number	Part Description	Width		Length		Print-On Area Height		Min. Cable O.D.		Max. Cable O.D.		Std. Pkg. Qty.	Std. Ctn. Qty.
		In.	mm	In.	mm	In.	mm	In.	mm	In.	mm		
S100X160YAJ	White print-on area, polyester label. For use with LabelCore™ Sleeves NWSLC-2Y and NWSLC-3Y.	1.00	25.4	1.60	40.6	0.80	20.3	0.25	6.4	0.25	6.4	2500	10000
S100X220YAJ	White print-on area, polyester label. For use with LabelCore™ Sleeves NWSLC-7Y.	1.00	25.4	2.20	55.9	1.10	27.9	0.35	8.9	0.35	8.9	1000	5000
S100X225YAJ	White print-on area, polyester label for 8 – 4 AWG wire, Cat. 6A UTP, FTP/Cat. 6 FTP cable.	1.00	25.4	2.25	57.2	0.75	19.1	0.24	6.1	0.48	12.1	1000	5000
S100X225YBJ	Blue print-on area, polyester label for 8 – 4 AWG wire, Cat. 6A UTP, FTP/Cat. 6 FTP cable.	1.00	25.4	2.25	57.2	0.75	19.1	0.24	6.1	0.48	12.1	1000	5000
S100X225YCJ	Brown print-on area, polyester label for 8 – 4 AWG wire, Cat. 6A UTP, FTP/Cat. 6 FTP cable.	1.00	25.4	2.25	57.2	0.75	19.1	0.24	6.1	0.48	12.1	1000	5000
S100X225YDJ	Green print-on area, polyester label for 8 – 4 AWG wire, Cat. 6A UTP, FTP/Cat. 6 FTP cable.	1.00	25.4	2.25	57.2	0.75	19.1	0.24	6.1	0.48	12.1	1000	5000
S100X225YEJ	Gray print-on area, polyester label for 8 – 4 AWG wire, Cat. 6A UTP, FTP/Cat. 6 FTP cable.	1.00	25.4	2.25	57.2	0.75	19.1	0.24	6.1	0.48	12.1	1000	5000
S100X225YFJ	Orange print-on area, polyester label for 8 – 4 AWG wire, Cat. 6A UTP, FTP/Cat. 6 FTP cable.	1.00	25.4	2.25	57.2	0.75	19.1	0.24	6.1	0.48	12.2	1000	5000
S100X225YGJ	Purple print-on area, polyester label for 8 – 4 AWG wire, Cat. 6A UTP, FTP/Cat. 6 FTP cable.	1.00	25.4	2.25	57.2	0.75	19.1	0.24	6.1	0.48	12.1	1000	5000
S100X225YHJ	Red print-on area, polyester label for 8 – 4 AWG wire, Cat. 6A UTP, FTP/Cat. 6 FTP cable.	1.00	25.4	2.25	57.2	0.75	19.1	0.24	6.0	0.48	12.1	1000	5000
S100X225YIJ	Yellow print-on area, polyester label for 8 – 4 AWG wire, Cat. 6A UTP, FTP/Cat. 6 FTP cable.	1.00	25.4	2.25	57.2	0.75	19.1	0.24	6.1	0.48	12.1	1000	5000
S100X400YAJ	White print-on area, polyester label for 2 – 1 AWG wire.	1.00	25.4	4.00	101.6	1.00	25.4	0.32	8.1	0.95	24.3	1000	5000
S100X650YAJ	White print-on area, polyester label for 1/0 – 350 MCM wire.	1.00	25.4	6.50	165.1	1.50	38.1	0.48	12.1	1.59	40.4	1000	5000
S150X400YAJ	White print-on area, polyester label for 2 – 1 AWG wire.	1.50	38.1	4.00	101.6	1.00	25.4	0.32	8.1	0.95	24.1	1000	5000
S150X400YIJ	Yellow print-on area, polyester label for 2 – 1 AWG wire..	1.50	38.1	4.00	101.6	1.00	25.4	0.32	8.1	0.95	24.1	1000	5000
S200X150YAJ	White print-on area, polyester label for Cat. 5e/Cat. 6/Cat. 6A UTP/Cat. 5e FTP cable.	2.00	50.8	1.50	38.1	0.50	12.7	0.16	4.1	0.32	8.1	1000	5000
S200X225YAJ	White print-on area, polyester label for 8 – 4 AWG wire, Cat. 6A UTP, FTP/Cat. 6 FTP cable.	2.00	50.8	2.25	57.2	0.75	19.1	0.24	6.1	0.48	12.1	1000	5000
S200X400YAJ	White print-on area, polyester label for 2 – 1 AWG wire.	2.00	50.8	4.00	101.6	1.00	25.4	0.32	8.1	0.95	24.1	1000	5000
S200X650YAJ	White print-on area, polyester label for 1/0 – 350 MCM wire.	2.00	50.8	6.50	165.1	1.50	38.1	0.48	12.1	1.59	40.4	500	2500

Wire Size Selection Guide

To use this guide place your wire or cable in the appropriate circle to determine wire, outside diameter.

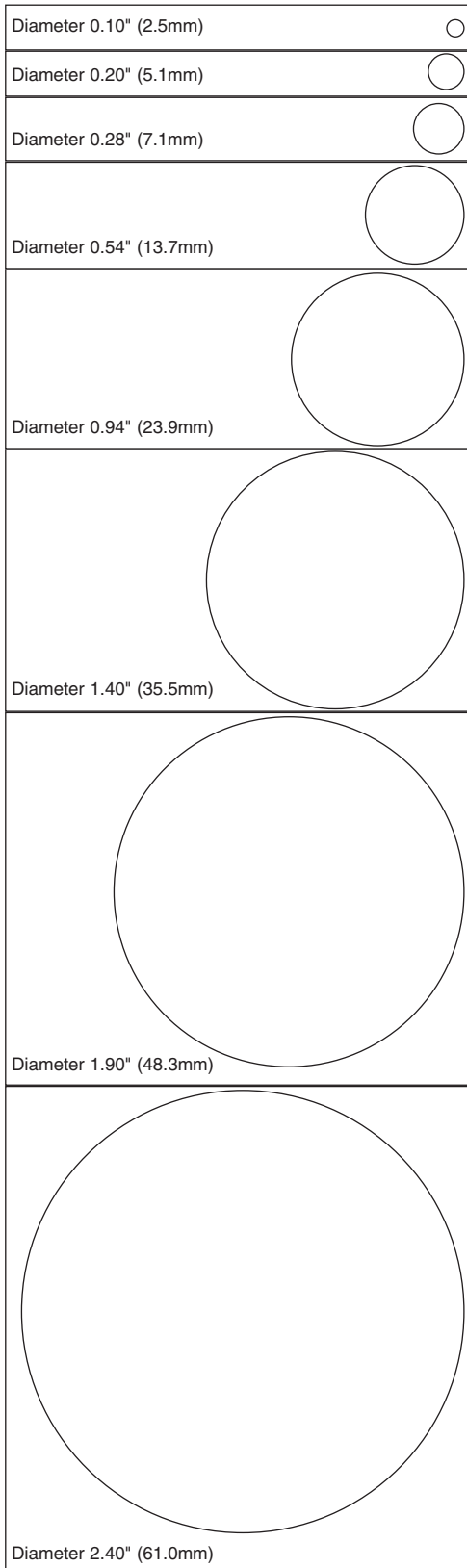

The charts below indicate the approximate cable outside diameter or various electrical and communication cables.

Electrical Cables

Approximate Wire Outside Diameter In. (mm)

Size	TF	THW	TW	TFN/THHN/THWN
18 AWG	0.11 (2.8)	0.11 (2.8)	0.11 (2.8)	0.09 (2.3)
16 AWG	0.12 (3.0)	0.12 (3.0)	0.12 (3.0)	0.10 (2.5)
14 AWG	0.13 (3.3)	0.16 (4.1)	0.16 (4.1)	0.10 (2.5)
12 AWG	0.15 (3.8)	0.18 (4.6)	0.18 (4.6)	0.12 (3.0)
10 AWG	0.17 (4.3)	0.20 (5.1)	0.20 (5.1)	0.15 (3.8)
8 AWG	0.24 (6.1)	0.28 (7.1)	0.28 (7.1)	0.22 (5.6)
6 AWG	0.32 (8.1)	0.32 (8.1)	0.32 (8.1)	0.26 (6.6)
4 AWG	0.37 (9.4)	0.37 (9.4)	0.37 (9.4)	0.33 (8.4)
3 AWG	0.40 (10.2)	0.40 (10.2)	0.40 (10.2)	0.36 (9.1)
2 AWG	0.43 (10.9)	0.43 (10.9)	0.43 (10.9)	0.39 (9.9)
1AWG	0.51 (12.9)	0.51 (12.9)	0.51 (12.9)	0.45 (11.4)
1/0	0.55 (14.0)	0.55 (14.0)	0.55 (14.0)	0.49 (12.4)
2/0	0.59 (15.0)	0.59 (15.0)	0.59 (15.0)	0.54 (13.7)
3/0	0.65 (16.5)	0.65 (16.5)	0.65 (16.5)	0.59 (15.0)
4/0	0.70 (17.8)	0.70 (17.8)	0.70 (17.8)	0.65 (16.5)
250 MCM	0.79 (20.1)	0.79 (20.1)	0.79 (20.1)	0.72 (18.3)
300 MCM	0.84 (21.3)	0.84 (21.3)	0.84 (21.3)	0.77 (19.6)
350 MCM	0.89 (22.6)	0.89 (22.6)	0.89 (22.6)	0.82 (20.8)
400 MCM	0.94 (23.9)	0.94 (23.9)	0.94 (23.9)	0.87 (22.1)
500 MCM	1.03 (26.2)	1.03 (26.2)	1.03 (26.2)	0.95 (24.1)
600 MCM	1.14 (29.0)	1.14 (29.0)	1.14 (29.0)	1.06 (26.9)
700 MCM	1.21 (30.7)	1.21 (30.7)	1.21 (30.7)	1.13 (28.7)
750 MCM	1.25 (31.8)	1.25 (31.8)	1.25 (31.8)	1.16 (29.5)
800 MCM	1.28 (32.5)	1.28 (32.5)	1.28 (32.5)	1.20 (30.5)
900 MCM	1.34 (34.0)	1.34 (34.0)	1.34 (34.0)	1.26 (32.0)
1000 MCM	1.40 (35.6)	1.40 (35.6)	1.40 (35.6)	1.32 (33.5)
1250 MCM	1.58 (40.1)	1.58 (40.1)	1.58 (40.1)	
1500 MCM	1.70 (43.2)	1.70 (43.2)	1.70 (43.2)	
1750 MCM	1.82 (46.2)	1.82 (46.2)	1.82 (46.2)	
2000 MCM	1.92 (48.8)	1.92 (48.8)	1.92 (48.8)	

Category 3, Category 5e, Category 6 and Category 6A Cable

Size	Category 3		Category 5e		Category 6		Category 6A	
	UTP Voice	UTP Data	UTP	FTP	UTP	FTP	UTP	FTP
2 Pair	0.12 (3.0)							
3 Pair	0.15 (3.8)							
4 Pair	0.19 (4.8)	0.22 (5.6)	0.20 (5.1)	0.25 (6.3)	0.22 (5.6)	0.28 (7.1)	0.32 (8.1)	0.30 (7.6)
25 Pair		0.42 (10.7)	0.51 (12.9)	0.73 (18.5)				
50 Pair	0.46 (11.7)	0.66 (16.8)						
100 Pair	0.63 (16.0)	0.96 (24.4)						
300 Pair	1.07 (27.2)	1.27 (32.2)						

Coaxial Cable

Size	Coax
RG58/u	0.19 (4.8)
RG59/u	0.24 (6.1)
RG62A/u	0.24 (6.1)
RG6/u	0.27 (6.8)
RG11/u	0.40 (10.2)

Fiber Optic Distribution (62.5/125)

Size	Non-Plenum	Plenum
6 Strand	0.26 (6.6)	0.18 (4.6)
8 Strand	0.27 (6.9)	0.18 (4.6)
12 Strand	0.28 (7.1)	0.21 (5.3)
18 Strand	0.49 (12.4)	0.47 (11.9)
24 Strand	0.54 (13.7)	0.52 (13.2)
36 Strand	0.54 (13.7)	0.52 (13.2)
48 Strand	0.59 (15.0)	0.56 (14.2)
72 Strand	0.72 (18.3)	0.71 (18.0)

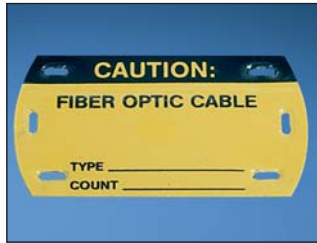
Self-Laminating Fiber Optic Cable Marker Tags**Material Chart**

Material	Print Method	Temperature Range	Features
Rigid Vinyl, Self-Laminating	Pre-Printed	0°F to 176°F (-18°C to 80°C)	Indoor/outdoor rated; high quality, rugged material resistant to abrasion; legend is protected by overlamine; use where adhesives will not work

Part Number	Legend	Color (Legend/Background)	Width		Height		Tags Per Pkg.	Std. Pkg. Qty.	Std. Ctn. Qty.
			In.	mm	In.	mm			
PST-FO	CAUTION FIBER OPTIC CABLE TYPE _____ COUNT _____	Black/Yellow	3.50	89.0	2.00	51.0	5	1	40
PST-FOBLNK	BLANK	Yellow	3.50	89.0	2.00	51.0	5	1	40

Photoluminescent Safety Signs

- Used to mark egress routes, fire alarms, and fire equipment that is clearly visible for up to ten hours after power is lost
- Absorbs energy from ambient light and releases this energy in the form of a glow when power is lost
- Recommended for use with Photoluminescent Tapes see page O.30 for more information
- Panduit Photoluminescent Signs meet or exceed the following safety standard specification for photoluminescent safety markings including: ASTM E 2072-00, ASTM E 2073-00, ASTM E 2030-99, DIN67510-1, IMO Resolution A.752.18, ISO/CD 15370, DIN 67510, UL 924, ASTM 162, ASTM 648, ASTM 662, MIL-L-3891 B, NFPA 101 Life Safety Code, OSHA 1910.37



PPS0710G001
PPS1014G002



PPS0710G020



PPS1209G010



PPS1209G011



PPS1209G012

Size Reference Chart

Part Number	Width		Height		Signs Per Card	Std. Pkg. Qty.
	In.	mm	In.	mm		
0710	10.00	254.0	7.00	177.8	1	1 Sign
1014	14.00	355.6	10.00	254.0	1	1 Sign
1209	9.00	228.6	12.00	304.8	1	1 Sign

*Denotes the part number's prefix and suffix.

Arc Flash Pre-Printed Labels

- Provide employees with the highest degree of safety through proper identification and communication
- New 2012 detailed format is compliant with NFPA 70E 2012 standard for Arc Flash labeling
- Clearly visible and recognizable hazard information to communicate Arc Flash hazards are present
- Large WARNING header, universal hazard symbols and clear, concise, hazard description

- New DANGER header signs available for high risk Arc Flash applications
- Multiple sizes to choose from for specific applications
- Labels are constructed of durable polyester (PPS), and designed to withstand UV exposure, outdoor use, water, abrasion or vinyl material (PVS) that accepts handwritten hazard information by using Panduit permanent black marking pens, part number - PFX-0



Basic



Standard



Detailed



Compact



Detailed Bilingual

Part Number	Part Description	Std. Pkg. Qty.	Std. Ctn. Qty.
Basic			
PPS0204W2100	4.50" x 2.25" (114.3mm x 57.2mm), black/orange, adhesive polyester sign, "WARNING". Potential Arc Flash Hazard.	5	100
PPS0204W2100-F	4.50" x 2.25" (114.3mm x 57.2mm), black/orange, adhesive polyester sign, "WARNING". Potential Arc Flash Hazard, written in French.	5	100
PPS0305W2100	3.50" x 5.00" (88.9mm x 127.0mm), black/orange, adhesive polyester sign, "WARNING". Potential Arc Flash Hazard.	5	50
PPS0507W2100	5.00" x 7.00" (127.0mm x 177.8mm), black/orange, adhesive polyester sign, "WARNING". Potential Arc Flash Hazard.	5	50
PPS0507W2100-F	5.00" x 7.00" (127.0mm x 177.8mm), black/orange, adhesive polyester sign, "WARNING". Potential Arc Flash Hazard, written in French.	5	50
Standard			
PVS0305W2102Y	3.50" x 5.00" (88.9mm x 127.0mm), WARNING (Header) orange and black, adhesive vinyl sign, "WARNING". ARC Flash and Shock Hazard.	5	50
PVS0305W2102Y-S	3.50" x 5.00" (88.9mm x 127.0mm), WARNING (Header) orange and black, adhesive vinyl sign, "WARNING". ARC Flash and Shock Hazard. Written in Spanish.	5	50
Detailed			
PVS0305W2103Y	3.50" x 5.00" (88.9mm x 127.0mm), WARNING (Header) orange and black, adhesive vinyl sign, "WARNING". Potential Arc Flash and Shock Hazard with detailed write-on area.	5	100
PVS0305D2101Y	3.50" x 5.00" (88.9mm x 127.0mm), DANGER (Header) red and white, adhesive vinyl sign, "DANGER". Potential Arc Flash Exists with detailed write-on area.	5	50
PVS0507W2103Y	5.00" x 7.00" (127.0mm x 177.8mm), WARNING (Header) orange and black, adhesive vinyl sign, "WARNING". Potential Arc Flash and Shock Hazard with detailed write-on area.	5	100
PVS0507D2101Y	5.00" x 7.00" (127.0mm x 177.8mm), DANGER (Header) red and white, adhesive vinyl sign, "DANGER". Potential Arc Flash Exists with detailed write-on area.	5	50
Compact			
PVS0204W2103Y	2.25" x 4.50" (57.2mm x 114.3mm), WARNING (Header) orange and black, adhesive vinyl sign, "WARNING". Potential Arc Flash and Shock Hazard with detailed write-on area.	5	100
PVS0204D2101Y	2.25" x 4.50" (57.2mm x 114.3mm), DANGER (Header) red and white, adhesive vinyl sign, "DANGER". Potential Arc Flash Exists with detailed write-on area.	5	100
Detailed Bilingual			
PVS0705W2105Y-S	7.00" x 5.00" (177.8mm x 127.0mm), WARNING (Header) orange and black, adhesive vinyl sign, "WARNING". Arc Flash and Shock Hazard, with detailed write-on area. Written in English and Spanish.	5	100
PVS0705D2105Y-S	7.00" x 5.00" (177.8mm x 127.0mm), DANGER (Header) red and white, adhesive vinyl sign, "DANGER". Arc Flash and Shock Hazard, with detailed write-on area. Written in English and Spanish.	5	100

Arc Flash Pre-Printed Labels with PPE Listings

- New 2012 detailed PPE format is compliant with NFPA 70E 2012 standard for Arc Flash labeling
- Provides helpful guide for employees to select PPE appropriate to the electrical hazard
- Labels are constructed of vinyl material (PVS) that accepts handwritten hazard information by using Panduit permanent black marking pens, part number - PFX-0
- Labels are 5.00" x 7.00" (127.0mm x 177.8mm) with large "WARNING" header

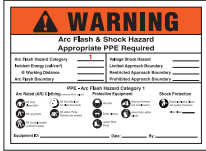

Detailed with PPE Pictograms

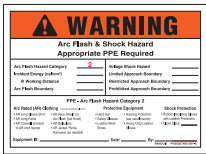

Detailed with PPE Listing

Part Number	Part Description	Std. Pkg. Qty.	Std. Ctn. Qty.
Detailed with PPE Pictograms			
PVS0507W2104Y-0	PPE Pictograms for Hazard Risk Category 0.	5	100
PVS0507W2104Y-1	PPE Pictograms for Hazard Risk Category 1.	5	100
PVS0507W2104Y-2	PPE Pictograms for Hazard Risk Category 2.	5	100
PVS0507W2104Y-3	PPE Pictograms for Hazard Risk Category 3.	5	100
PVS0507W2104Y-4	PPE Pictograms for Hazard Risk Category 4.	5	100
Detailed with PPE Listing			
PVS0507W2106Y-0	PPE Listing for Hazard Risk Category 0.	5	100
PVS0507W2106Y-1	PPE Listing for Hazard Risk Category 1.	5	100
PVS0507W2106Y-2	PPE Listing for Hazard Risk Category 2.	5	100
PVS0507W2106Y-3	PPE Listing for Hazard Risk Category 3.	5	100
PVS0507W2106Y-4	PPE Listing for Hazard Risk Category 4.	5	100

Arc Flash Print On-Demand Labels

- Custom Arc Flash Hazard Labels can be printed using Panduit labeling software and desktop thermal transfer printers with resin ribbons
- Provide employees with the highest degree of safety through proper identification and communication
- New 2012 detailed format is compliant with NFPA 70E 2012 standard for Arc Flash labeling
- Clearly visible and recognizable hazard information to communicate arc flash hazards present
- Labels are constructed of durable polyester designed to withstand UV exposure, outdoor use, water and abrasion



C400X400A11 C400X400A51 C400X400Y21 C400X600A51 C400X600Y21 C400X600YX1 T400X000A91 T400X000YX1

Part Number	Part Description	Std. Pkg. Qty.	Std. Ctn. Qty.
C200X400A51	2.00" x 4.00" (50.8mm x 101.6mm), polyester safety label, WARNING (Header) orange and black, 250 labels per roll.	1	4
C200X400Y21	2.00" x 4.00" (50.8mm x 101.6mm), polyester safety label, DANGER (Header) red and white, 250 labels per roll.	1	4
C400X400A11*	4.00" x 4.00" (101.6mm x 101.6mm), polyester safety label, orange header, green footer, 250 labels per roll.	1	4
C400X400A21*	4.00" x 4.00" (101.6mm x 101.6mm), polyester safety label, orange header, yellow footer, 250 labels per roll.	1	4
C400X400A31*	4.00" x 4.00" (101.6mm x 101.6mm), polyester safety label, orange header, red footer, 250 labels per roll.	1	4
C400X400A51	4.00" x 4.00" (101.6mm x 101.6mm), polyester safety label, WARNING (Header) orange and black, 250 labels per roll.	1	4
C400X400Y21	4.00" x 4.00" (101.6mm x 101.6mm), polyester safety label, DANGER (Header) red and white, 250 labels per roll.	1	4
C400X600A51	4.00" x 6.00" (101.6mm x 152.4mm), polyester safety label, WARNING (Header) orange and black, 100 labels per roll.	1	4
C400X600YX1	4.00" x 6.00" (101.6mm x 152.4mm), polyester arc flash label, orange header, 100 labels per roll.	1	4
C400X600Y21	4.00" x 6.00" (101.6mm x 152.4mm), polyester safety label, DANGER (Header) red and white, 100 labels per roll.	1	4

Arc Flash Print On-Demand Continuous Tape

T400X000A91	4.00" x 50.00' (101.6mm x 15.2m), polyester arc flash tape, red header.	1	4
T400X000YX1	4.00" x 50.00' (101.6mm x 15.2m), polyester arc flash tape, orange header.	1	4

*It is suggested to use the green footer for Hazard Risk Categories 0 and 1, the yellow footer for categories 2 and 3, and the red footer for categories 4 and Danger.

Voltage and Fiber Optic Markers



Style	Width		Height		Pipe/Conduit O.D. Range		Markers Per Card
	In.	mm	In.	mm	In.	mm	
A	9.00	228.0	2.25	57.1	3.00 and Over	76.2 and Over	1
B	4.50	114.3	1.13	28.6	1.25 – 3.00	31.7 – 76.2	4
C	2.20	57.1	0.50	12.7	1.25 – Under	31.7 and Under	18

Material Chart

Material	Print Method	Temperature Range	Features
Vinyl	Pre-Printed	-20°F to 176°F (-29°C to 80°C)	Indoor rated; material has excellent adhesive properties when applied to a clean dry surface.

Part Number			Legend	Color (Legend/Background)	Std. Pkg. Qty.	Std. Ctn. Qty.
Style A	Style B	Style C				
PCV-110AY	PCV-110BY	PCV-110CY	110 Volts	Black/Orange	5	50
PCV-115AY	PCV-115BY	PCV-115CY	115 Volts		5	50
PCV-120/208AY	PCV-120/208BY	PCV-120/208CY	120/208 Volts		5	50
PCV-120AY	PCV-120BY	PCV-120CY	120 Volts		5	50
PCV-12470AY	PCV-12470BY	PCV-12470CY	12470 Volts		5	50
PCV-13200AY	PCV-13200BY	PCV-13200CY	13200 Volts		5	50
PCV-13800AY	PCV-13800BY	PCV-13800CY	13800 Volts		5	50
PCV-1PHAY	PCV-1PHBY	PCV-1PHCY	Single Phase		5	50
PCV-208AY	PCV-208BY	PCV-208CY	208 Volts		5	50
PCV-220AY	PCV-220BY	PCV-220CY	220 Volts		5	50
PCV-2300AY	PCV-2300BY	PCV-2300CY	2300 Volts		5	50
PCV-230AY	PCV-230BY	PCV-230CY	230 Volts		5	50
PCV-2400AY	PCV-2400BY	PCV-2400CY	2400 Volts		5	50
PCV-240AY	PCV-240BY	PCV-240CY	240 Volts		5	50
-	PCV-24VDCBY	-	24 Volts DC		5	50
PCV-277/480AY	PCV-277/480BY	PCV-277/480CY	277/480 Volts		5	50
PCV-277AY	PCV-277BY	PCV-277CY	277 Volts		5	50
PCV-380AY	PCV-380BY	PCV-380CY	380 Volts		5	50
PCV-3PHAY	PCV-3PHBY	PCV-3PHCY	Three Phase		5	50
PCV-415AY	PCV-415BY	PCV-415CY	415 Volts		5	50
PCV-4160AY	PCV-4160BY	PCV-4160CY	4160 Volts		5	50
PCV-440AY	PCV-440BY	PCV-440CY	440 Volts		5	50
PCV-460AY	PCV-460BY	PCV-460CY	460 Volts		5	50
PCV-480AY	PCV-480BY	PCV-480CY	480 Volts		5	50
PCV-600AY	PCV-600BY	PCV-600CY	600 Volts		5	50
PCV-BLANKAY	PCV-BLANKBY	PCV-BLANKCY	Blank-No Legend		5	50
PCV-ESAY	PCV-ESBY	PCV-ESCY	Emergency Service		5	50
PCV-FAAY	PCV-FABY	PCV-FACY	Fire Alarm		5	50
PCV-FOAY	PCV-FOBY	PCV-FOCY	Fiber Optic		5	50
PCV-FOCAY	PCV-FOCBY	PCV-FOCCY	Fiber Optic Cable		5	50
PCV-MAINAY	PCV-MAINBY	PCV-MAINCY	Main	5	50	
PCV-TELEAY	PCV-TELEBY	PCV-TELECY	Telephone	5	50	

Voltage and Fiber Optic Snap-On Markers (Non-Adhesive)



Style	Width		Height		Pipe/Conduit O.D. Range		Markers Per Card
	In.	mm	In.	mm	In.	mm	
M	14.00	355.6	23.00	584.2	2.25 – 6.00	57.2 – 152.4	1
R	8.00	230.2	8.00	230.2	0.75 – 2.25	19.1 – 57.2	1

Material Chart

Material	Print Method	Temperature Range	Features
Polyester	Pre-Printed	-40°F to 176°F (-40°C to 80°C)	Indoor/outdoor rated; pre-coiled material protects legend from abrasion and chemicals; resistant to UV light chemical atmosphere and abrasion.

Part Number		Legend	Color (Legend/Background)	Std. Pkg. Qty.	Std. Ctn. Qty.
Style M	Style R				
	PCV-120RY	120 Volts	Black/Orange	1	25
	PCV-480RY	480 Volts		1	25
PCV-FOMY	PCV-FORY	Fiber Optic		1	25

Photoluminescent Tapes – Thermal Transfer Printable



Normal Lighting

- Used to mark egress routes, fire alarms, and fire equipment that is clearly visible for up to ten hours after power is lost
- Absorb energy from ambient light and releases this energy in the form of a glow when power is lost
- Can be used in Panduit thermal transfer desktop printers to create direction arrow tape, striped tape, or safety signs on demand
- Panduit photoluminescent tapes meet or exceed the following safety standard specification for photoluminescent safety markings including: ASTM E 2072-00, ASTM E 2073-00, ASTM E 2030-99, DIN67510-1, IMO Resolution A.752.18, ISO/CD 15370, DIN 67510, UL924, ASTM 162, ASTM 648, ASTM 662, MIL-L-3891 B, NFPA 101 Life Safety Code, OSHA 1910.37
- Recommended for use with Photoluminescent Safety Signs see page O.26 for more information



Black Light

Material Chart

Material	Print Method	Temperature Range	Features
Polyester, Photoluminescent (Y2)	Thermal Transfer (T)	-40°F to 230°F (-40°C to 110°C)	Indoor/outdoor rated; provides durability, high temperature resistance and dimensional stability; does not stretch or easily tear; after power is lost, material emits glow that is clearly visible for up to 10 hours.

Part Number	Part Description	Width		Roll Length		Std. Pkg. Qty.	Std. Ctn. Qty.
		In.	mm	Ft.	m		

Pre-Printed

PT2S-ARW	Photoluminescent, polyester tape, black arrow.	2.00	50.8	30.0	9.1	1	4
PT2S-BLK	Photoluminescent, polyester tape, black stripe.	2.00	50.8	30.0	9.1	1	4
PT2S-RED	Photoluminescent, polyester tape, red stripe.	2.00	50.8	30.0	9.1	1	4

Blank

T200X000Y2T	Photoluminescent, polyester tape.	2.00	50.8	15.0	4.5	1	4
T400X000Y2T	Photoluminescent, polyester tape.	4.00	101.6	15.0	4.5	1	4

Order number of rolls required.

Labels roll mounted on 3.00" cores; when using the TDP43ME thermal transfer desktop printer and 3.00" cores, the roll stand (TDP43M-RS) is required.



PT2S-ARW



PT2S-BLK



PT2S-RED

WIRING DUCT

Panduit® Panduct® Wiring Duct is designed to manage, protect, and conceal cabling. Available in a wide selection of styles, sizes, colors and materials, Panduct® Wiring Duct meets a variety of application and environmental needs. For network cabling, Panduit provides solutions from backboard applications in the telecommunications room to cord management at the workstation. All Panduct® Wiring Ducts are UL Recognized and CSA Certified.

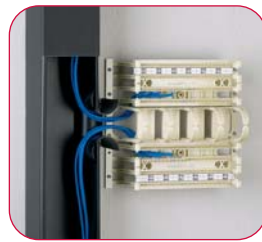
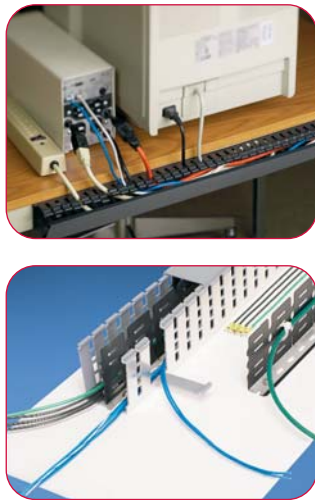

- PanelMax™ Shielded Wiring Duct and Noise Shield provide two options to route, protect, and shield sensitive wiring from noise emission
- Type H, HN, and HS hinged cover wiring duct feature a dual-sided hinging cover for convenient channel access and prevents cover loss for superior aesthetics
- Type G wide slot PVC wiring duct is ideal for managing larger diameter cables and is available in a wide range of sizes in black color
- Type FS solid wall PVC raceway completely conceals and protects cabling for longer trunking runs where frequent breakouts are not required
- Type FL flexible wiring duct is made of a flexible polypropylene material to handle non-uniform mounting surfaces and reduce installation time

Panduit continues to lead the industry in the development of comprehensive cable management systems that deliver design flexibility, ease of installation, and lowest cost of ownership. As part of the Panduit Industrial Automation Solution, Panduct® Wiring Duct offers safe and reliable system integration within the physical infrastructure.

Wiring Duct for Backboard Mounted Applications Roadmap

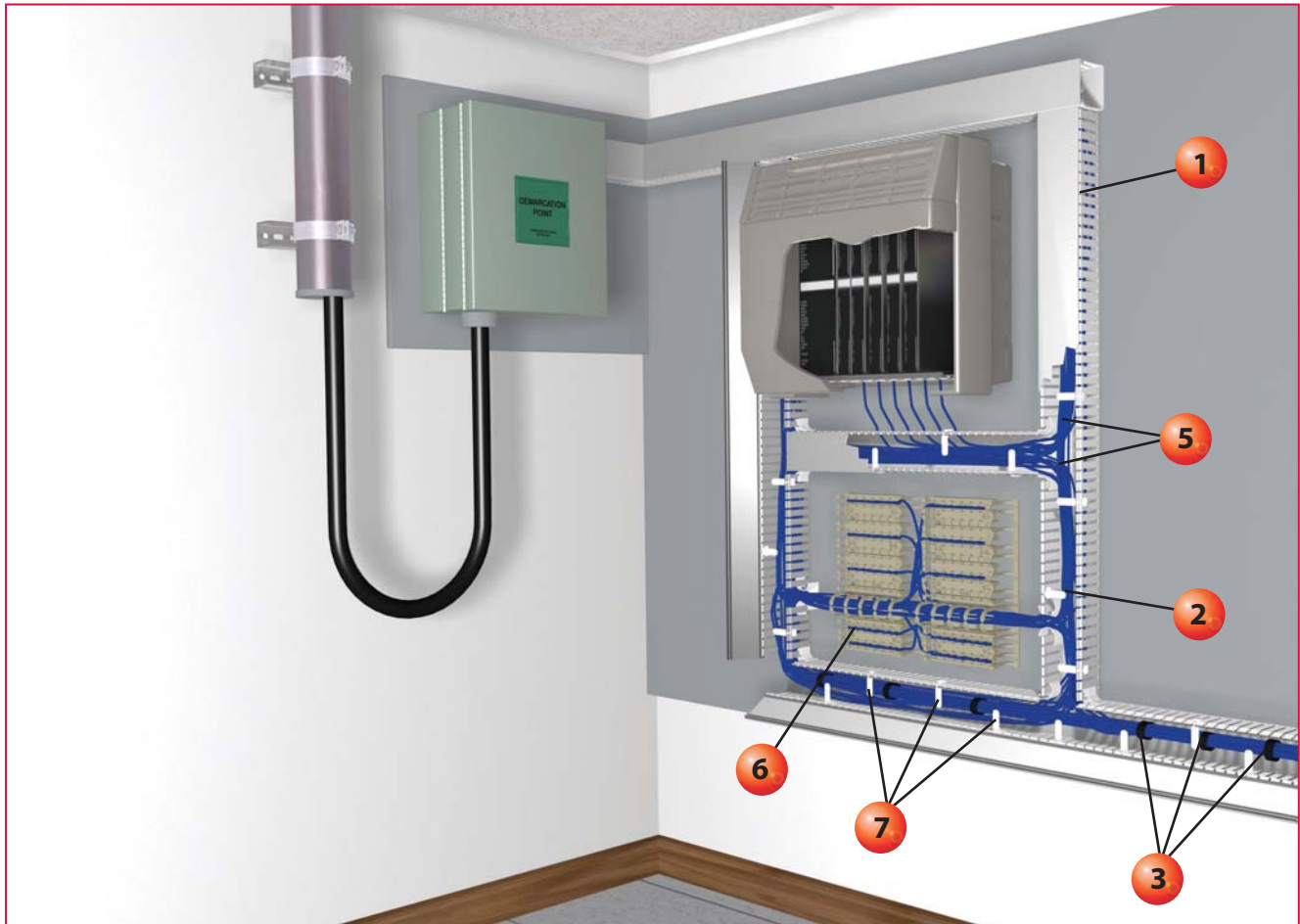

1

Panduct® Type H Hinged Cover Wiring Duct
(page P.5)

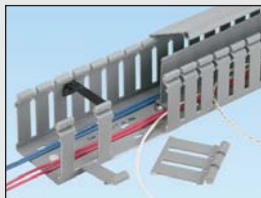

3

Tak-Tape™ Hook & Loop Cable Tie Rolls
(page P.21)



2

Fiber-Duct™ Bend Radius Control Trumpets
(page P.14)



4

Ultra-Cinch™ Hook & Loop Ties and Tak-Ty® Hook & Loop Cable Ties
(pages P.22)



Wiring Duct for Cord Management at the Workstation Roadmap

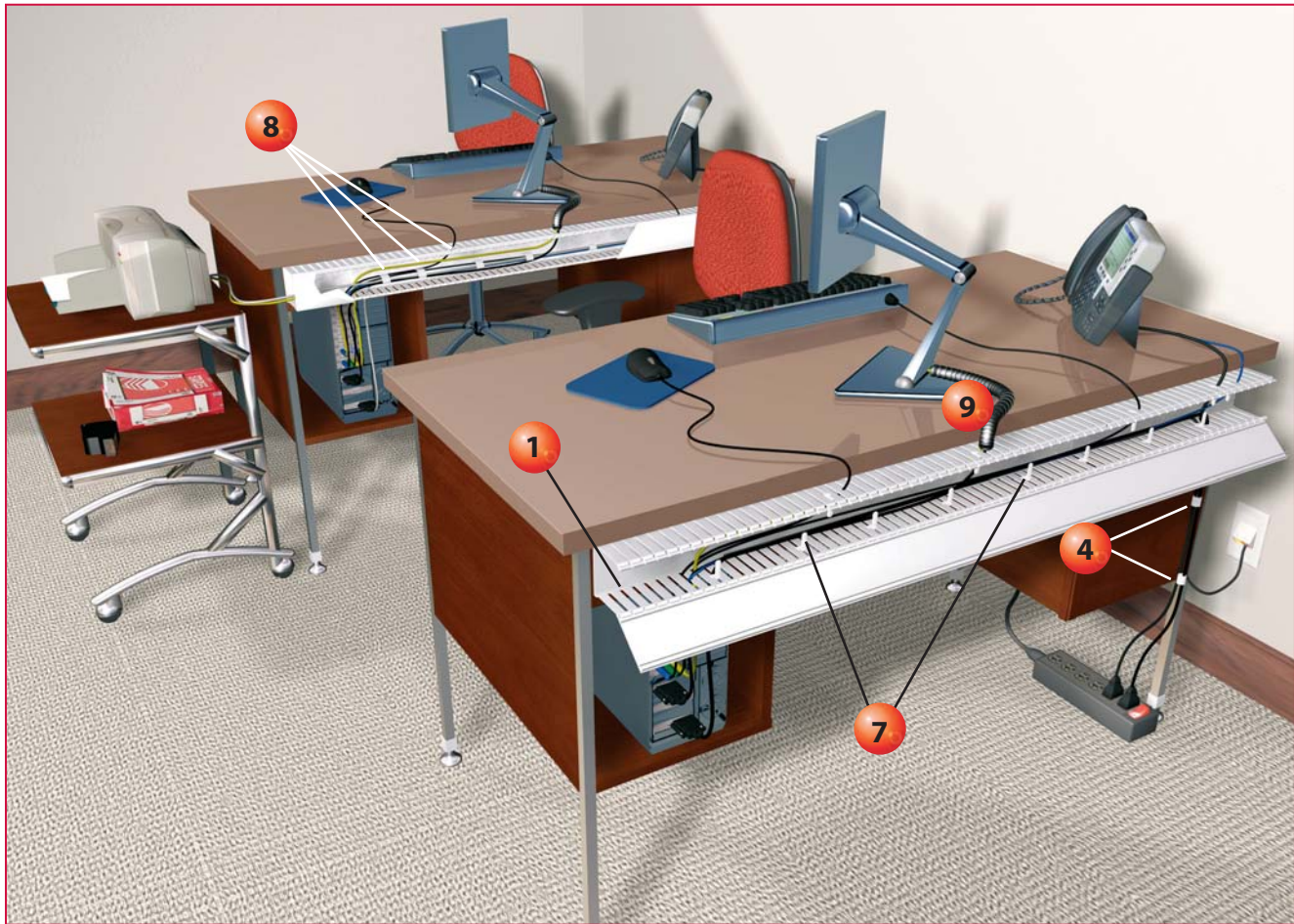

5 Panduct® Bend Radius Control Strips (page P.14)



7 Panduct® Type G and H Wiring Duct Wire Retainers (page P.12)



6 GP6™ PLUS Punchdown System (pages B.79 – B.81)

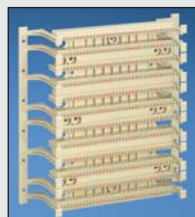

8 Tak-Ty® Hook & Loop Cable Tie Mounts (page P.39)



9 Corrugated Loom Tubing (page P.51)





Panduct® PanelMax™ Shielded Wiring Duct

- The shielded wiring duct routes, separates, and shields sensitive wiring from noise emission
- Up to 20dB noise reduction, 90% noise voltage reduction (up to 6 inches air space)
- Lead-free PVC with metallic foil finish
- UL recognized continuous-use temperature – 122°F (50°C)
- Provided with mounting holes
- Base and cover length is 6 feet
- Use with Type C cover (purchased separately)

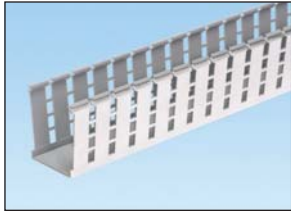

Part Number	Part Description	Std. Pkg. Qty.
G2X2LG6EMI	2" x 2" PanelMax™ Shielded Wiring Duct in two 6-foot lengths. Foil metal finish. Cover sold separately.	12
G2X3LG6EMI	2" x 3" PanelMax™ Shielded Wiring Duct in two 6-foot lengths. Foil metal finish. Cover sold separately.	12
G2X4LG6EMI	2" x 4" PanelMax™ Shielded Wiring Duct in two 6-foot lengths. Foil metal finish. Cover sold separately.	12

Use C2LG6 or C2WH6 cover with shielded wiring duct. Standard package quantity in feet.

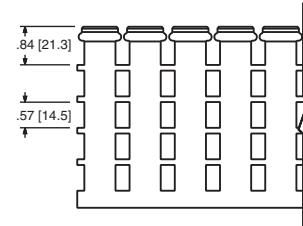
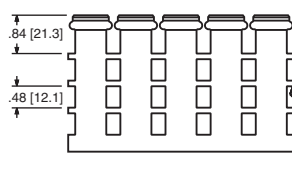
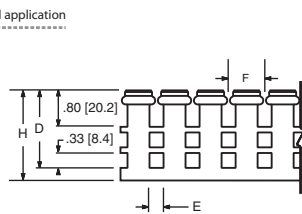
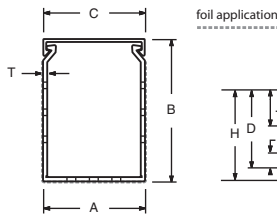

Part Number	Dimensions – Inches (mm)								
	A	B	C	D	E	F	H	K	T
G2X2LG6EMI	2.25 (57.2)	2.12 (53.8)	2.25 (57.2)	1.63 (41.3)	0.31 (7.9)	0.8 (20.3)	2 (50.8)	0.5 (12.7)	0.08 (2.0)
G2X3LG6EMI	2.25 (57.2)	3.12 (79.2)	2.25 (57.2)	2.63 (66.7)	0.31 (7.9)	1 (25.4)	3 (76.2)	0.5 (12.7)	0.1 (2.4)
G2X4LG6EMI	2.25 (57.2)	4.1 (104.1)	2.25 (57.2)	3.63 (92.1)	0.31 (7.9)	1 (25.4)	4 (101.6)	0.5 (12.7)	0.11 (2.7)

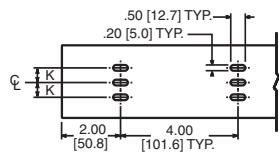

Panduct® PanelMax™ Noise Shield

- Used within Panduit wiring duct or mounted separately, PanelMax™ Noise Shield separates and shields sensitive wiring from noise emission
- Up to 20dB noise reduction, 90% noise voltage reduction (up to 6 inches air space)
- Material: zinc-plated steel with black powder coating on vertical surfaces

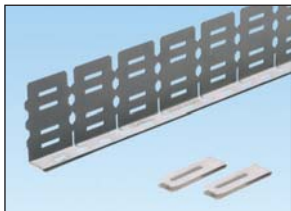

Part Number	Part Description	Std. Pkg. Qty.
SD2EMI	EMI noise shield kit for 2" height Panduit wiring duct; two 3-foot sections, bonding clips, and anti-oxidizing paste.	1
SD3EMI	EMI noise shield kit for 3" height Panduit wiring duct; two 3-foot sections, bonding clips, and anti-oxidizing paste.	1
SD4EMI	EMI noise shield kit for 4" height Panduit wiring duct; two 3-foot sections, bonding clips, and anti-oxidizing paste.	1
SDCLIP	Replacement bonding clip for use with SD*EMI.	1

Standard package quantity in kits.

Part No.	X In. (mm)
SD2EMI	1.82 [46.1]
SD3EMI	2.88 [73.2]
SD4EMI	3.86 [98.2]

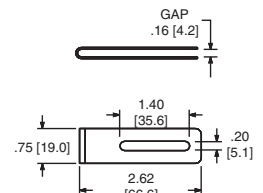
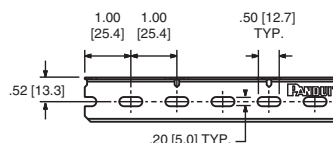
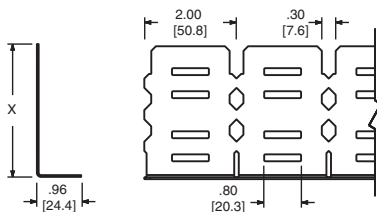

cUL[®] US C E Panduct[®] Type H – Hinged Cover Wiring Duct

Specifications

- Material: Lead-free PVC
- UL Recognized continuous use temperature: 122°F (50°C)
- UL94 flammability rating of V-0
- Conforms with NFPA 79-2007 section 13.3.1 requirement for flame retardant material
- Provided with mounting holes
- Base and cover length is 6 feet

Features and Benefits

- Integrated hinged cover design allows easy access to wiring without hassle of removing and reinstalling cover
- Dual-sided hinge can open up to 100° from either sidewall of duct base for easy access to channel
- Cover retention flanges prevent cover from sliding when installed on duct base
- Double scoreline saves installation time and lowers installed cost
- Restricted slot design retains wire in slot for fast, easy wire installation or removal

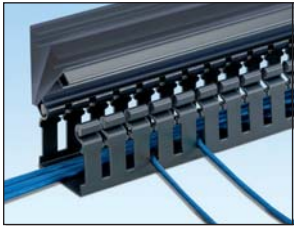

Base Part Number	Duct Size (W x H)		Cover Part Number	Std. Pkg. Qty. (Ft.)	Base Ctn. Qty. (Ft.)	Cover Ctn. Qty. (Ft.)
	In.	mm				
H1.5X2BL6	1.75 x 1.98	44.5 x 50.3	HC1.5BL6	6	120	120
H1.5X3BL6	1.75 x 3.06	44.5 x 77.7	HC1.5BL6	6	120	120
H2X2BL6	2.17 x 1.98	55.1 x 50.3	HC2BL6	6	120	120
H2X3BL6	2.17 x 3.06	55.1 x 77.7	HC2BL6	6	60	120
H2X4BL6	2.17 x 4.10	55.1 x 104.1	HC2BL6	6	60	120
H3X3BL6	3.25 x 3.06	82.6 x 77.7	HC3BL6	6	60	120
H3X4BL6	3.25 x 4.10	82.6 x 104.1	HC3BL6	6	60	120
H4X4BL6	4.25 x 4.10	108.0 x 104.1	HC4BL6	6	60	60

For other colors replace BL (Black) with LG (Light Gray) or WH (White).
Order number of feet required, in multiples of 6' or Standard Carton Quantity.
Base and cover sold separately.
Height dimension includes duct with cover.

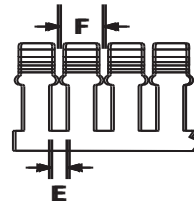
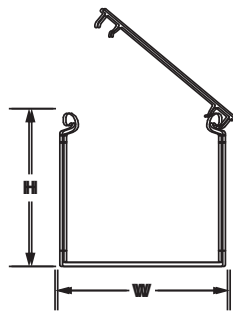

	E	F
For 2" Duct Height:	0.31" (7.9)	0.80" (20.3)
3" to 4" Height:	0.31" (7.9)	1.00" (25.4)

cUL[®] us Panduct[®] Type HN Hinged Cover Narrow Slot Wiring Duct

Specifications:

- Material: Lead-free PVC
- UL Recognized continuous use temperature: 122°F (50°C)
- UL 94 flammability rating of V-0
- Conforms with NFPA 79-2007 section 13.3.1 requirement for flame retardant material
- Provided with mounting holes
- Base and cover length is 6 feet

Features and Benefits

- Narrow slot and finger design provides excellent wire management with smaller wire diameters and high-density components
- Integrated hinged cover design allows easy access to wiring without hassle of removing and reinstalling cover
- Dual-sided hinge can open up to 100° from either sidewall of duct base for easy access to channel
- Cover retention flanges prevent cover from sliding when installed on duct base
- Double scoreline saves installation time and lowers installed cost
- Restricted slot design retains wire in slot for fast, easy wire installation or removal

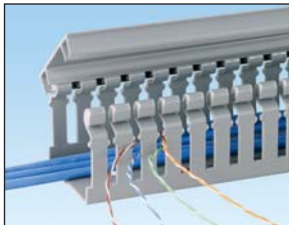

Base Part Number	Duct Size (W x H*)		Cover Part Number	Std. Pkg. Qty. (Ft.)	Base Ctn. Qty. (Ft.)	Cover Ctn. Qty. (Ft.)
	In.	mm				
HN1.5X2LG6	1.75 x 1.98	44.5 x 50.3	HC1.5LG6	6	120	120
HN1.5X3LG6	1.75 x 3.06	44.5 x 77.7	HC1.5LG6	6	120	120
HN2X2LG6	2.17 x 1.98	55.1 x 50.3	HC2LG6	6	120	120
HN2X3LG6	2.17 x 3.06	55.1 x 77.7	HC2LG6	6	60	120
HN2X4LG6	2.17 x 4.10	55.1 x 104.1	HC2LG6	6	60	120
HN3X3LG6	3.25 x 3.06	82.6 x 77.7	HC3LG6	6	60	120
HN3X4LG6	3.25 x 4.10	82.6 x 104.1	HC3LG6	6	60	120
HN4X4LG6	4.25 x 4.10	108.0 x 104.1	HC4LG6	6	60	60

Part Number shown for LG (Light Gray). Available in WH (White).

Base and cover sold separately.

*Height dimension includes duct with cover.

Order number of feet required, in multiples of 6' or Standard Carton Quantity.

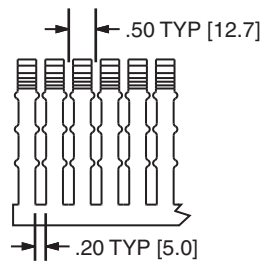
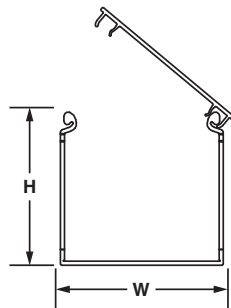

Multiple Slot Restrictors Present with 2" and Greater Duct Wall Height

cUL[®] US C E Panduct® Type HS Hinged Cover Solid Wall Raceway

- Material: Lead-free PVC
- Rated for continuous use temperature: 122°F (50°C)
- UL94 flammability rating V-0
- Conforms with NFPA 79-2007 section 13.3.1 requirement for flame-retardant material
- Base and cover length is 6 feet (base and cover sold separately)
- Solid wall design fully encloses cables providing maximum protection and aesthetics
- Integrated hinged cover design allows easy access to wiring without hassle of removing and reinstalling cover
- Dual-sided hinge can open up to 100° from either sidewall of duct base for easy access to channel
- Cover retention flanges prevent cover from sliding when installed on duct base
- Base scoreline allows full wire carrying capacity at wiring duct junctions such as tees and corners
- Specially formulated lead-free material eliminates health concerns associated with PVC which contains lead

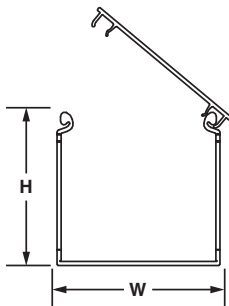

Base Part Number	Duct Size (W x H)		Cover Part Number	Std. Pkg. Qty. (Ft.)	Base Ctn. Qty. (Ft.)	Cover Ctn. Qty. (Ft.)
	In.	mm				
HS1.5X2LG6NM	1.75 x 1.98	44.5 x 50.3	HC1.5LG6	6	120	120
HS1.5X3LG6NM	1.75 x 3.06	44.5 x 77.7	HC1.5LG6	6	60	120
HS2X2LG6NM	2.17 x 1.98	55.1 x 50.3	HC2LG6	6	120	120
HS2X3LG6NM	2.17 x 3.06	55.1 x 77.7	HC2LG6	6	60	120
HS2X4LG6NM	2.17 x 4.10	55.1 x 104.1	HC2LG6	6	60	120
HS3X3LG6NM	3.25 x 3.06	82.6 x 77.7	HC3LG6	6	60	120
HS3X4LG6NM	3.25 x 4.10	82.6 x 104.1	HC3LG6	6	60	120
HS4X4LG6NM	4.25 x 4.10	108.0 x 104.1	HC4LG6	6	60	60

Part numbers shown available in LG (Light Gray) and WH (White). 2 x 2 and 4 x 4 sizes available in BL (Black) colors.

Base and cover sold separately.

Height dimension includes duct with cover.

Order number of feet required, in multiples of 6' or Standard Carton Quantity.

A.
System
Overview

B.
Copper
Systems

C.
Fiber
Optic
Systems

D.
Power
over
Ethernet

E.
Zone
Cabling

F.
Wireless

G.
Outlets

H.
Media
Distribution

I.
Physical
Infrastructure
Management

J.
Overhead &
Underfloor
Routing

K.
Surface
Raceway

L.
Cabinets,
Racks &
Cable
Management

M.
Grounding &
Bonding

N.
Industrial

O.
Labeling &
Identification

P.
Cable
Management
Accessories

Q.
Index

UL® SP® C E Panduct® Type NNC Halogen-Free Metric Wiring Duct

- Material: Halogen-free modified polyphenylene oxide (mPPO) material as verified with IEC 60754-2 test method (test on gases evolved during combustion of electric cables)
- UL recognized continuous-use temperature: 221°F (105°C)
- UL 94 flammability rating of V-0

- Conforms with NFPA 79-2007 section 13.3.1 requirement for flame-retardant material
- Provided with DIN 43 659 mounting holes
- Metric sizing and finger progression
- Duct and cover packaged together in two meter lengths

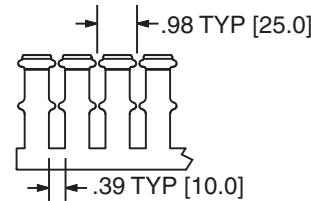
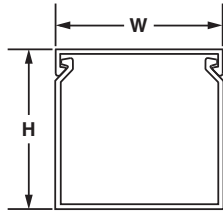
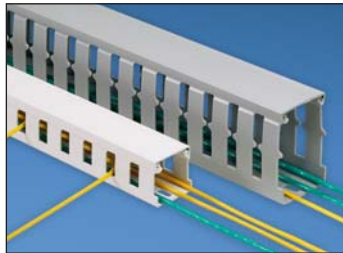

Multiple slot restrictors present with 75mm and greater duct wall height.

Base and Cover Part Number	Duct Size (W x H)		Slot Width		Replacement Cover Part Number	Base and Cover Ctn. Qty. (m)	Replacement Cover Ctn. Qty. (m)
	mm	In.	mm	In.			
NNC25X25LG2	24.6 x 23.6	0.97 x 0.93	10.0	0.39	NC25LG2	20	20
NNC25X37LG2	24.6 x 35.8	0.97 x 1.41	10.0	0.39	NC25LG2	20	20
NNC25X50LG2	24.6 x 47.8	0.97 x 1.88	10.0	0.39	NC25LG2	20	20
NNC25X75LG2	24.6 x 72.4	0.97 x 2.35	10.0	0.39	NC25LG2	20	20
NNC37X37LG2	37.1 x 35.8	1.46 x 1.41	10.0	0.39	NC37LG2	20	20
NNC37X50LG2	37.1 x 47.8	1.46 x 1.88	10.0	0.39	NC37LG2	20	20
NNC37X75LG2	37.1 x 72.4	1.46 x 2.85	10.0	0.39	NC37LG2	20	20
NNC50X50LG2	49.5 x 47.8	1.95 x 1.88	10.0	0.39	NC50LG2	20	20
NNC50X75LG2	49.5 x 72.4	1.95 x 2.85	10.0	0.39	NC50LG2	10	20
NNC50X100LG2	49.5 x 97.8	1.95 x 3.85	10.0	0.39	NC50LG2	10	20
NNC75X75LG2	74.7 x 72.4	2.94 x 2.85	10.0	0.39	NC75LG2	10	20
NNC100X50LG2	99.6 x 47.8	3.92 x 1.88	10.0	0.39	NC100LG2	10	20
NNC100X75LG2	99.6 x 72.4	3.92 x 2.85	10.0	0.39	NC100LG2	10	20
NNC100X100LG2	99.6 x 97.8	3.92 x 3.85	10.0	0.39	NC100LG2	10	20

For white color replace LG (Light Gray) with WH (White).

DO NOT allow cutting, tapping or cleaning fluids that contain hydrocarbons to come in contact with type NNC wiring duct as it will cause stress cracking.

Order by total number of meters required, in multiples of Standard Carton Quantity.

Height dimension includes duct with cover.

Panduct® Type NNC Divider Wall

- NNC solid divider wall can be mounted inside NNC and NE wiring duct to create multiple channels
- Material: Halogen-free modified polyphenylene oxide (mPPO)

- Simply install the divider wall base when mounting the duct and snap the divider wall onto mounting base, DB-C



Part Number	Length (m)	For Nominal Duct Height (mm)	Std. Pkg. Qty.	Std. Ctn. Qty. (m)
NNC50DWH2	2	50	2	40
NNC75DWH2	2	75	2	40

Available in WH (White) color only.

NOTE: Must be used with mounting base DB-C, which is sold separately. Install mounting bases to the duct channel, locate within 2" of each divider wall end and at least every 12" along the length.

Panduct Type TNC Low-Smoke, Halogen-Free Slotted Wall Wiring Duct

- Low-smoke, halogen-free material meets the regulatory requirements of the mass transit industry and other regulated environments
- UL recognized continuous-use temperature: 221°F (105°C)
- Flammability rating of UL94 V-0
- Rail standard compliance/rating: NFPA 130, DIN 5510-2, BSS 7239, NFF 16101, NFF 16102, EN UNI 11925-2
- Provided with DIN 43 659 mounting holes
- Metric sizing and finger progression

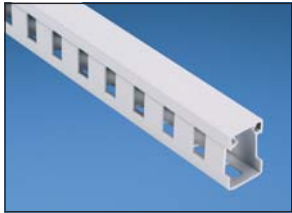

Base and Cover Part Number	Duct Size (W x H)		Replacement Cover Part Number	Base and Cover Ctn. Qty. (m)	Replacement Cover Ctn. Qty. (m)
	mm	In.			
TNC25X37LG2	24.6 x 35.8	0.97 x 1.41	TNC25LG2	20	20
TNC25X75LG2	24.6 x 72.4	0.97 x 2.85	TNC25LG2	20	20
TNC37X37LG2	37.1 x 35.8	1.46 x 1.41	TNC37LG2	20	20
TNC37X75LG2	37.1 x 72.4	1.46 x 2.85	TNC37LG2	20	20
TNC50X50LG2	49.6 x 47.8	1.95 x 1.88	TNC50LG2	20	20
TNC75X75LG2	74.6 x 72.4	2.94 x 2.85	TNC75LG2	10	10
TNC100X50LG2	99.6 x 47.8	3.92 x 1.88	TNC100LG2	10	10
TNC100X75LG2	99.6 x 47.8	3.92 x 2.85	TNC100LG2	10	10

Divider Wall Part Number	Length		For Nominal Duct Height		Std. Pkg. Qty.	Std. Ctn. Qty. (m)
	mm	Ft.	mm	In.		
TNC50D2	2.00	6.56	50	2	2	40
TNC75D2	2.00	6.56	75	3	2	40

Panduit[®] Type G – Wide Slot Wiring Duct

Specifications

- Material: Lead-free PVC
- UL Recognized continuous use temperature: 122°F (50°C)
- UL94 flammability rating of V-0
- Conforms with NFPA 79-2007 section 13.3.1 requirement for flame retardant material
- Provided with mounting holes
- Base and cover length is 6 feet

Features and Benefits

- Wide finger design provides greater rigidity and larger slot width
- Panduit exclusive rounded edges will not cut hands or abrade wiring insulation
- Non-slip cover will not slide easily when installed on duct base
- Flush cover design holds more wires than traditional duct designs
- Double scoreline saves installation time and lowers installed cost
- Specially formulated lead-free material eliminates health concerns associated with PVC that contains lead
- Restricted slot design retains wire in slot for fast, easy wire installation or removal

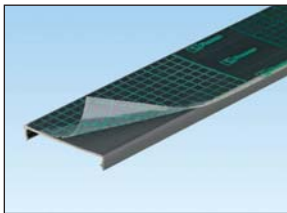
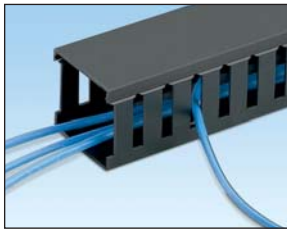

To order cover with protective film add "-F" to part number.

Base Part Number	Duct Size (W x H)		Cover Part Number	Std. Pkg. Qty. (Ft.)	Base Ctn. Qty. (Ft.)	Cover Ctn. Qty. (Ft.)
	In.	mm				
G.75X2BL6	0.93 x 2.03	23.6 x 51.7	C.75BL6	6	120	120
G1X1BL6	1.26 x 1.12	32.0 x 28.4	C1BL6	6	120	120
G1X1.5BL6	1.26 x 1.62	32.0 x 41.1	C1BL6	6	120	120
G1X2BL6	1.26 x 2.12	32.0 x 53.8	C1BL6	6	120	120
G1X3BL6	1.26 x 3.12	32.0 x 79.2	C1BL6	6	120	120
G1X4BL6	1.26 x 4.10	32.0 x 104.1	C1BL6	6	60	120
G1.5X1.5BL6	1.75 x 1.62	44.5 x 41.1	C1.5BL6	6	120	120
G1.5X2BL6	1.75 x 2.12	44.5 x 53.8	C1.5BL6	6	120	120
G1.5X3BL6	1.75 x 3.12	44.5 x 79.2	C1.5BL6	6	120	120
G1.5X4BL6	1.75 x 4.10	44.5 x 104.1	C1.5BL6	6	60	120
G2X1BL6	2.25 x 1.12	57.2 x 28.4	C2BL6	6	120	120
G2X2BL6	2.25 x 2.12	57.2 x 53.8	C2BL6	6	120	120
G2X3BL6	2.25 x 3.12	57.2 x 79.2	C2BL6	6	60	120
G2X4BL6	2.25 x 4.10	57.2 x 104.1	C2BL6	6	60	120
G2.5X3BL6	2.75 x 3.12	69.9 x 79.2	C2.5BL6	6	120	120
G3X2BL6	3.25 x 2.12	82.6 x 53.8	C3BL6	6	120	120
G3X3BL6	3.25 x 3.12	82.6 x 79.2	C3BL6	6	60	120
G3X4BL6	3.25 x 4.10	82.6 x 104.1	C3BL6	6	60	120
G4X2BL6	4.25 x 2.12	108.0 x 53.8	C4BL6	6	60	120
G4X3BL6	4.25 x 3.12	108.0 x 79.2	C4BL6	6	60	120
G4X4BL6	4.25 x 4.10	108.0 x 104.1	C4BL6	6	60	120
G4X5BL6	4.25 x 5.10	108.0 x 129.5	C4BL6	6	60	120

For other colors replace BL (Black) with LG (Light Gray) or WH (White).
Order number of feet required, in multiples of 6' or Standard Carton Quantity.
Height dimension includes duct with cover.
Base and cover sold separately.

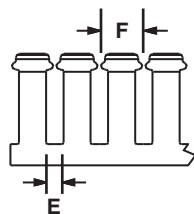
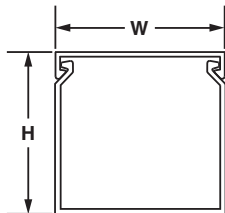

	E	F
For 0.5" Duct Height:	0.31" (9.4)	0.80" (20.3)
0.75" to 2" Duct Height:	0.31" (7.9)	0.80" (20.3)
3" to 4" Duct Height:	0.31" (7.9)	1.00" (25.4)
5" Duct Height:	0.38" (9.4)	1.33" (33.8)

Panduct® Type FS Solid Wall Raceway

Specifications

- Material: Lead-free PVC
- UL Recognized continuous use temperature: 122°F (50°C)
- UL94 flammability rating of V-0
- Supplied without mounting holes
- Base and cover length is 6 feet

Features and Benefits

- Solid wall design fully encloses cables providing maximum protection and aesthetics
- Non-slip cover will not slide easily when installed on duct base
- Flush cover design holds more wires than traditional duct designs
- Base scoreline allows full wire carrying capacity at wiring duct junctions such as tees and corners
- Specially formulated lead-free material eliminates health concerns associated with PVC which contains lead

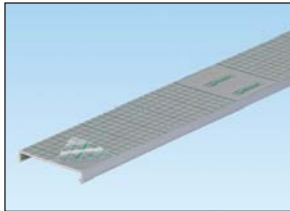
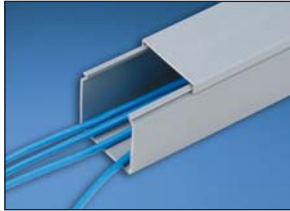

To order cover with protective film add "F" to part number. Six inch cover not available with protective film.

Base Part Number	Duct Size (W x H)		Cover Part Number	Std. Pkg. Qty. (Ft.)	Base Ctn. Qty. (Ft.)	Cover Ctn. Qty. (Ft.)
	In.	mm				
> FS.5X.5LG6NM	0.69 x 0.60	17.5 x 15.2	C.5LG6	6	120	120
> FS.5X1LG6NM	0.69 x 1.06	17.5 x 26.9	C.5LG6	6	120	120
FS.75X.75LG6NM	0.93 x 0.82	23.6 x 20.8	C.75LG6	6	120	120
> FS1X1LG6NM	1.26 x 1.12	32.0 x 28.4	C1LG6	6	120	120
> FS1X1.5LG6NM	1.26 x 1.62	32.0 x 41.1	C1LG6	6	120	120
FS1X2LG6NM	1.26 x 2.12	32.0 x 53.8	C1LG6	6	120	120
FS1X3LG6NM	1.26 x 3.12	32.0 x 79.2	C1LG6	6	120	120
FS1X4LG6NM	1.26 x 4.10	32.0 x 104.1	C1LG6	6	60	120
> FS1.5X1LG6NM	1.75 x 1.12	44.5 x 28.4	C1.5LG6	6	120	120
> FS1.5X1.5LG6NM	1.75 x 1.62	44.5 x 41.1	C1.5LG6	6	120	120
> FS1.5X2LG6NM	1.75 x 2.12	44.5 x 53.8	C1.5LG6	6	120	120
> FS1.5X3LG6NM	1.75 x 3.12	44.5 x 79.2	C1.5LG6	6	120	120
> FS2X1LG6NM	2.25 x 1.12	57.2 x 28.4	C2LG6	6	120	120
FS2X1.5LG6NM	2.25 x 1.62	57.2 x 41.1	C2LG6	6	120	120
> FS2X2LG6NM	2.25 x 2.12	57.2 x 53.8	C2LG6	6	120	120
> FS2X3LG6NM	2.25 x 3.12	57.2 x 79.2	C2LG6	6	60	120
> FS2X4LG6NM	2.25 x 4.10	57.2 x 104.1	C2LG6	6	60	120
> FS3X1LG6NM	3.25 x 1.12	82.6 x 28.4	C3LG6	6	120	120
> FS3X2LG6NM	3.25 x 2.12	82.6 x 53.8	C3LG6	6	120	120
> FS3X3LG6NM	3.25 x 3.12	82.6 x 79.2	C3LG6	6	60	120
FS3X4LG6NM	3.25 x 4.10	82.6 x 104.1	C3LG6	6	60	120
FS3X5LG6NM	3.25 x 5.10	82.6 x 129.5	C3LG6	6	60	120
FS4X1.5LG6	4.25 x 1.62	108.0 x 41.1	C4LG6	6	120	120
> FS4X2LG6NM	4.25 x 2.12	108.0 x 53.8	C4LG6	6	60	120
> FS4X3LG6NM	4.25 x 3.12	108.0 x 79.2	C4LG6	6	60	120
> FS4X4LG6NM	4.25 x 4.10	108.0 x 104.1	C4LG6	6	60	120
> FS4X5LG6NM	4.25 x 5.10	108.0 x 129.5	C4LG6	6	60	120
> FS6X4LG6NM	6.25 x 4.15	158.8 x 105.4	C6LG6	6	60	120

>Indicates parts available with mounting holes. Remove NM from part number.
For other colors replace LG (Light Gray) with WH (White) or BL (Black), available in selected sizes.
Order number of feet required, in multiples of 6' or Standard Carton Quantity.
Height dimension includes duct with cover.
Base and cover sold separately.

Panduct® Type FL Flexible Wiring Duct

Specifications

- Material: Flexible Polypropylene
- UL Recognized continuous use temperature: 149°F (65°C)
- UL94 flammability rating of V-2
- Factory applied adhesive tape provided for easy mounting
- Base and cover length is 19.7 inches

Features and Benefits

- The flexibility of type FL wiring duct allows it to be used in applications where conventional rigid PVC duct cannot
- One-piece design with enclosing fingers simplifies insertion and removal of wiring

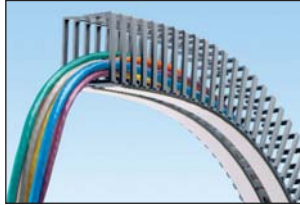

Part Number	Duct Size (W x H)		Std. Pkg. Qty. (Pcs.)
	In.	mm	
FL12X12LG-A	0.49 x 0.49	12.5 x 12.5	112
FL25X25LG-A	0.98 x 0.98	25.0 x 25.0	70
FL50X50LG-A	1.97 x 1.97	50.0 x 50.0	32

Available in LG (RAL 7040 Light Gray) color only.

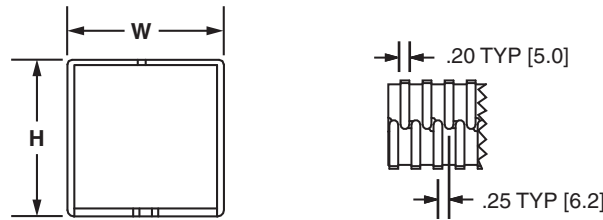

Panduct® Type G and H Wiring Duct Wire Retainers

- Insert between fingers of type G and H wiring duct to contain wiring when cover is removed
- Adjustable height
- Material: ABS



Part Number	For Duct Width In. (mm)	For Duct Height In. (mm)	Std. Pkg. Qty. (Pcs.)	Std. Ctn. Qty. (Pcs.)
WR2-C	2.00 (50.8)	2.00 – 4.00 (50.8 – 101.6)	100	1000
WR2H-C*	2.00 (50.8)	2.00 – 4.00 (50.8 – 101.6)	100	1000
WR3-C	3.00 (76.2)	2.00 – 4.00 (50.8 – 101.6)	100	1000
WR4-C	4.00 (101.6)	2.00 – 4.00 (50.8 – 101.6)	100	1000
WR5-C	Use with: 3 x 5, 4 x 5, or 6 x 4	Use with: 3 x 5, 4 x 5, or 6 x 4	100	1000

*WR2H-C – For use with 2" width Type H hinged cover wiring duct.



Panduct® Divider Wall

- Wiring duct divider walls can be mounted inside any type of Panduit PVC wiring duct to create multiple channels
- Simply install the divider wall base when mounting the duct and snap the divider wall onto the mounting base accessory (shown below)
- All versions snap onto DB-C mounting base
- Divider wall heights 2" and greater have a scoreline feature allowing sections to be removed leaving a smooth edge



Part Number	Length (Ft.)	For Nominal Duct Height		Std. Pkg. Qty.	Std. Ctn. Qty.
		In.	mm		
Panduct® Solid Divider Wall					
D2H6	6	2.00	50	6	120
D3H6	6	3.00	75	6	120
D4H6	6	4.00	100	6	120
D2HWH6	6	2.00	50	6	120
D3HWH6	6	3.00	75	6	120
D4HWH6	6	4.00	100	6	120
Panduct® Slotted Divider Wall					
SD2H6	6	2.00	50	6	120
SD3H6	6	3.00	75	6	120
SD4H6	6	4.00	100	6	120
SD2HWH6	6	2.00	50	6	120
SD3HWH6	6	3.00	75	6	120
SD4HWH6	6	4.00	100	6	120

Adhesive Tape

- Recommended installation temperature is 70°F (21°C)
- UL Recognized service temperature is 32°F (0°C) to 140°F (60°C)
- Optimum recommended dwell time for acrylic adhesive is 8 hours
- Recommended tape load is 1/2 lb. per square inch of tape area



Duct Size (W x H)	Tape Part Number	Roll Length		Std. Pkg. Qty.	Std. Ctn. Qty.
		Yds.	m		
0.5 x 0.5 – 1.5 x 4*	P32W2A2-50-7	7	6.4	1	100
	P32W2A2-50-72	72	65.5	1	9
2 x 1 – 3 x 3	P32W2A2-50-7	7	6.4	1	100
	P32W2A2-50-72	72	65.5	1	9
3 x 4 – 3 x 5	P32W2A2-75-7	7	6.4	1	60
	P32W2A2-75-72	72	65.5	1	7
4 x 1.5 – 4 x 3	P32W2A2-50-7	7	6.4	1	100
	P32W2A2-75-72	72	65.5	1	9
4 x 4 – 6 x 4	P32W2A2-75-7	7	6.4	1	60
	P32W2A2-75-72	72	65.5	1	7

*Note: 1.5 x 1.5 duct uses 3/4" width tape.

Specifications For Tape Application

Duct Size (W x H)	Rows of Tape	Tape			
		Width		Thickness	
		In.	mm	In.	mm
0.5 x 0.5 – 0.75 x 2	1	0.50	12.7	0.03	0.8
1 x 1 – 1.5 x 4	1	0.75	19.1	0.03	0.8
2 x 1 – 3 x 3	2	0.50	12.7	0.03	0.8
3 x 4 – 3 x 5	2	0.75	19.1	0.03	0.8
4 x 1.5 – 4 x 3	2	0.50	12.7	0.03	0.8
4 x 4 – 6 x 4	2	0.75	19.1	0.03	0.8

Panduct[®] Duct Corner Strip with 1" Bend Radius Control

- Create a strong rigid corner at wiring duct junctions
- Provide bend radius protection for cabling as required in NFPA 79-2007 section 13.1.5.9 and TIA/EIA-568-B and 569-A
- Available in 6 foot lengths that can be cut to size to meet any size requirement
- Easy to install two-piece design
- Compatible with all styles of Panduit wiring duct
- UL 94 flammability rating of V-0
- Material: Lead-free PVC

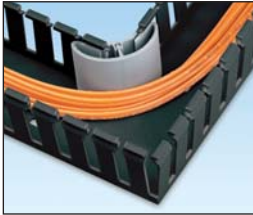

Cutting Guide for Duct Corner Strips

Part Number	Part Description	For Duct Height		Color	Std. Pkg. Qty. (Pcs.)	Std. Ctn. Qty. (Pcs.)
		In.	mm			
6' Lengths for use with all Types of PVC Wiring Duct						
CSC1LG6	Cut-to-size 6 foot corner strip with a 1" bend radius.	All sizes (Cut to height)*	All sizes (Cut to height)*	Light Gray	6	120

Order number of feet required, in multiples of 6' or Standard Package Quantity.
*Refer to Cutting Guide below.

Used with Duct Height	Cut-to-Size*	Used with Metric Duct Height	Cut-to-Size*
1 inch	0.47" (11.9)	25mm	0.43" (10.9)
1.5 inch	1.04" (26.4)	37mm	0.91" (23.1)
2 inch	1.23" (31.2)	50mm	1.39" (35.3)
2.5 inch	1.97" (50.0)	62mm	1.85" (47.0)
3 inch	2.27" (57.7)	75mm	2.38" (60.5)
4 inch	3.25" (82.5)	100mm	3.35" (85.1)
5 inch	4.47" (113.5)		

*Cut-to-size measure fits into the flat area of the duct sidewall.

Fiber-Duct[™] Bend Radius Control Trumpets

- Available for 2" and 4" wall height type G slotted wall wiring duct and type FS solid wall raceway
- TRC2HDBL is available for 2" wall height type H hinged cover wiring duct
- Provide method to transition cabling from wall mounted hardware to wiring duct channel
- Maintain complete 1" bend radius control

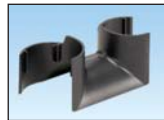
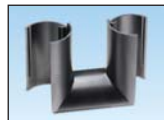

Part Number	Part Description	For Duct Height		Std. Pkg. Qty. (Pcs.)	Std. Ctn. Qty. (Pcs.)
		In.	mm		
TRC2BL	Bend radius control trumpet for exiting at the sidewall of 2" wall heights of type G, FS, or E Fiber-Duct [™] Channels.	2.00	50.8	1	10
TRC4BL	Bend radius control trumpet for exiting at the sidewall of 4" wall heights of type G, FS, or E Fiber-Duct [™] Channels.	4.00	101.6	1	10
TRC2HDBL	Bend radius control trumpet for exiting at the sidewall of 2" wall heights of type H hinged cover wiring duct channels.	2.00	50.8	1	10
TRC4HDBL	Bend radius control trumpet for exiting at the sidewall of 4" wall heights of type H hinged cover wiring duct channels.	4.00	101.6	1	10

All product color is black.

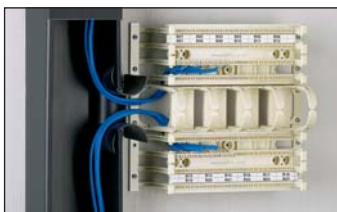

Panduct® Installation Tools

- DCT easily cuts any Panduct® Duct and Cover
- DNT-100 notches sidewalls to bottom scoreline for tees and corner junctions



DCT



DNT-100



PBDCT

Part Number	Part Description	Std. Pkg. Qty.
Duct Cutting Tools		
DCT	Hand-held duct cutting tool.	1
Replacement Blade Kit (includes blade and nylon insert)		
DNT-100	Hand-held sidewall notching tool.	1
Bench Mount Wiring Duct Cutting Tool		
PBDCT	Bench mount cutter tool for slotted wiring duct and cover with telescoping measure.	1
PBDCT-BLD	Replacement blade for PBDCT bench mount wiring duct cutter.	1

Always use approved safety goggles when using any tools.

Panduct® Type HN, H, and HS Wiring Duct – Wirefill Capacity

Nominal Duct Size (W x H) In.	Nominal Area In. ²	Electrical															Communication								
		8 AWG			10 AWG			12 AWG			14 AWG			16 AWG			18 AWG			22 AWG		23 AWG	23/24 AWG	24 AWG	Fiber Cable
		0.216	0.164	0.130	0.141	0.152	0.111	0.124	0.133	0.096	0.111	0.118	0.084	0.100	0.106	0.085	0.300	0.240	0.240	0.225	0.118				
		THHN	THHN	THHN	MTW	MTW	THHN	MTW	MTW	TFFN	MTW	MTW	TFFN	MTW	MTW	MTW	Cat. 6A	Cat. 6A (SD)	Cat. 6	Cat. 5e	3.0 mm				
1.50 x 2.00	3.000	34	60	95	81	70	131	105	91	175	131	116	229	162	144	224	18	28	28	32	116				
1.50 x 3.00	4.500	52	90	143	122	105	197	158	137	263	197	174	344	243	216	336	27	42	42	48	174				
2.00 x 2.00	4.000	46	80	127	108	93	175	140	122	234	175	155	306	216	192	299	24	37	37	42	154				
2.00 x 3.00	6.000	69	120	191	163	140	263	210	183	351	263	232	459	324	288	448	36	56	56	64	232				
2.00 x 4.00	8.000	92	160	255	217	187	350	281	244	469	350	310	612	432	384	598	48	75	75	85	309				
3.00 x 3.00	9.000	104	180	287	244	210	394	316	275	527	394	349	689	486	432	673	54	84	84	96	348				
3.00 x 4.00	12.000	139	241	383	326	280	526	421	366	703	526	465	919	648	577	897	72	112	112	128	464				
4.00 x 4.00	16.000	185	321	511	435	374	701	562	488	938	701	621	1225	864	769	1197	96	150	150	170	619				

Table shows maximum wire fill based on 50% of duct internal cross sectional area. Formula = Nominal Area/1.85 x D². All dimensions represent typical outer cable diameter in inches.

Panduct® Shielded Wiring Duct – Wirefill Capacity

Nominal Duct Size (W x H) In.	Nominal Area In. ²	Electrical															Communication								
		8 AWG			10 AWG			12 AWG			14 AWG			16 AWG			18 AWG			22 AWG		23 AWG	23/24 AWG	24 AWG	Fiber Cable
		0.216	0.164	0.130	0.141	0.152	0.111	0.124	0.133	0.096	0.111	0.118	0.084	0.100	0.106	0.085	0.300	0.240	0.240	0.225	0.118				
		THHN	THHN	THHN	MTW	MTW	THHN	MTW	MTW	TFFN	MTW	MTW	TFFN	MTW	MTW	MTW	Cat. 6A	Cat. 6A (SD)	Cat. 6	Cat. 5e	3.0 mm				
2.00 x 2.00	4.000	48	84	135	114	98	185	148	129	248	185	164	323	228	203	316	25	39	39	45	163				
2.00 x 3.00	6.000	73	127	202	172	148	278	222	193	372	278	246	485	342	305	474	38	59	59	67	245				
2.00 x 4.00	8.000	97	169	270	229	197	371	297	258	496	371	328	647	457	406	632	50	79	79	90	327				

Table shows maximum wire fill based on 50% of duct internal cross sectional area. Formula = Nominal Area / 1.75 x D². All dimensions represent typical outer cable diameter in inches. The above communication cable diameters represent the nominal Panduit cable diameter per performance level. For specific cable fill information based on specific part numbers, please contact Panduit customer service.

Panduct® Type G and FS Wiring Duct – Wirefill Capacity

Nominal Duct Size (W x H) In.	Nominal Area In. ²	Electrical															Communication					
		8 AWG		10 AWG		12 AWG			14 AWG			16 AWG			18 AWG		22 AWG	23 AWG		23/24 AWG	24 AWG	Fiber Cable
		0.216	0.164	0.13	0.141	0.152	0.111	0.124	0.133	0.096	0.111	0.118	0.084	0.100	0.106	0.085	0.300	0.240	0.250	0.225	0.118	
		THHN	THHN	THHN	MTW	MTW	THHN	MTW	MTW	TFFN	MTW	MTW	TFFN	MTW	MTW	MTW	Cat. 6A	Cat. 6A (SD)	Cat. 6	Cat. 5e	3.0 mm	
0.50 x 0.50	0.250	3	5	8	7	6	11	9	8	15	11	10	20	14	12	19	1	2	2	2	10	
0.50 x 1.00	0.500	6	10	16	14	12	23	18	16	31	23	20	40	28	25	39	3	4	4	5	20	
0.50 x 2.00	1.000	12	21	33	28	24	46	37	32	62	46	41	80	57	50	79	6	9	9	11	40	
0.50 x 4.00	2.000	24	42	67	57	49	92	74	64	124	92	82	161	114	101	158	12	19	19	22	81	
0.75 x 0.75	0.563	6	11	19	16	13	26	20	18	34	26	23	45	32	28	44	3	5	5	6	23	
0.75 x 1.00	0.750	9	15	25	21	18	34	27	24	46	34	30	60	42	38	59	4	7	7	8	30	
0.75 x 1.50	1.125	13	23	38	32	27	52	41	36	69	52	46	91	64	57	88	7	11	11	12	46	
0.75 x 2.00	1.500	18	31	50	43	37	69	55	48	93	69	61	121	85	76	118	9	14	14	16	61	
1.00 x 1.00	1.000	12	21	33	28	24	46	37	32	62	46	41	80	57	50	79	6	9	9	11	40	
1.00 x 1.50	1.500	18	31	50	43	37	69	55	48	93	69	61	121	85	76	118	9	14	14	16	61	
1.00 x 2.00	2.000	24	42	67	57	49	92	74	64	124	92	82	161	114	101	158	12	19	19	22	81	
1.00 x 3.00	3.000	36	63	101	86	74	139	111	96	186	139	123	242	171	152	237	19	29	29	33	122	
1.00 x 4.00	4.000	48	84	135	114	98	185	148	129	248	185	164	323	228	203	316	25	39	39	45	163	
1.50 x 1.00	1.500	18	31	50	43	37	69	55	48	93	69	61	121	85	76	118	9	14	14	16	61	
1.50 x 1.50	2.250	27	47	76	64	55	104	83	72	139	104	92	182	128	114	177	14	22	22	25	92	
1.50 x 2.00	3.000	36	63	101	86	74	139	111	96	186	139	123	242	171	152	237	19	29	29	33	122	
1.50 x 3.00	4.500	55	95	152	129	111	208	167	145	279	208	184	364	257	228	355	28	44	44	50	184	
1.50 x 4.00	6.000	73	127	202	172	148	278	222	193	372	278	246	485	342	305	474	38	59	59	67	245	
2.00 x 1.00	2.000	24	42	67	57	49	92	74	64	124	92	82	161	114	101	158	12	19	19	22	81	
2.00 x 1.50	3.000	36	63	101	86	74	139	111	96	186	139	123	242	171	152	237	19	29	29	33	122	
2.00 x 2.00	4.000	48	84	135	114	98	185	148	129	248	185	164	323	228	203	316	25	39	39	45	163	
2.00 x 3.00	6.000	73	127	202	172	148	278	222	193	372	278	246	485	342	305	474	38	59	59	67	245	
2.00 x 4.00	8.000	97	169	270	229	197	371	297	258	496	371	328	647	457	406	632	50	79	79	90	327	
2.00 x 5.00	10.000	122	212	338	287	247	463	371	323	620	463	410	809	571	508	790	63	99	99	112	409	
2.50 x 3.00	7.500	91	159	253	215	185	347	278	242	465	347	307	607	428	381	593	47	74	74	84	307	
3.00 x 1.00	3.000	36	63	101	86	74	139	111	96	186	139	123	242	171	152	237	19	29	29	33	122	
3.00 x 2.00	6.000	73	127	202	172	148	278	222	193	372	278	246	485	342	305	474	38	59	59	67	245	
3.00 x 3.00	9.000	110	191	304	258	222	417	334	290	558	417	369	728	514	457	711	57	89	89	101	368	
3.00 x 4.00	12.000	146	254	405	344	296	556	445	387	744	556	492	971	685	610	949	76	119	119	135	491	
3.00 x 5.00	15.000	183	318	507	431	370	695	557	484	930	695	615	1214	857	762	1186	95	148	148	169	614	
4.00 x 1.50	6.000	73	127	202	172	148	278	222	193	372	278	246	485	342	305	474	38	59	59	67	245	
4.00 x 2.00	8.000	97	169	270	229	197	371	297	258	496	371	328	647	457	406	632	50	79	79	90	327	
4.00 x 3.00	12.000	146	254	405	344	296	556	445	387	744	556	492	971	685	610	949	76	119	119	135	491	
4.00 x 4.00	16.000	195	339	540	459	395	742	594	516	992	742	656	1295	914	813	1265	101	158	158	180	655	
4.00 x 5.00	20.000	244	424	676	574	494	927	743	646	1240	927	820	1619	1142	1017	1581	126	198	198	225	819	
6.00 x 4.00	24.000	293	509	811	689	593	1113	891	775	1488	1113	984	1943	1371	1220	1898	152	238	238	270	983	

Table shows maximum wire fill based on 50% of duct internal cross sectional area. Formula = Nominal Area/1.75 x D². All dimensions represent typical outer cable diameter in inches.

Panduct® Type FL Wiring Duct – Wirefill Capacity

Nominal Duct Size (W x H) mm	Nominal Area mm ²	Electrical															Communication				
		8 AWG		10 AWG		12 AWG			14 AWG			16 AWG			18 AWG		22 AWG	23 AWG	23/24 AWG	24 AWG	Fiber Cable
		5.5	4.2	3.3	3.6	3.9	2.8	3.1	3.4	2.4	2.8	3.0	2.1	2.5	2.7	2.2	8.4	6.4	4.8	3.0	
		THHN	THHN	THHN	MTW	MTW	THHN	MTW	MTW	TFFN	MTW	MTW	TFFN	MTW	MTW	MTW	Cat. 6A	Cat. 6	Cat. 5e	3.0 mm	
12 x 12	144	1	3	5	4	3	7	5	5	9	7	6	12	8	7	12	0	1	2	6	
25 x 25	625	8	14	22	19	16	31	25	21	42	31	27	54	38	34	53	3	6	10	27	
50 x 50	2500	33	57	91	77	67	125	100	87	168	125	111	219	155	137	214	14	24	42	111	

Table shows maximum wire fill based on 50% of duct internal cross sectional area. Formula = Nominal Area/2.50 x D². All dimensions represent typical outer cable diameter in millimeters.

Wirefill Formula

General Formula

Panduit wiring duct wirefills are calculated using the following general formula:

$$50\% \text{ Wirefill} = 50\% \text{ of } \left(\frac{\text{Usable Duct Area}}{\text{Wire Area}} \right)$$

Why use a 50% Wirefill?

As specified in NFPA79-2007 section 13.5.2, *Percentage Fills of Raceways (Ducts)*, a 50% wirefill is given as the maximum wirefill capacity in all Panduit wiring ducts. This helps ensure general safe wiring practices are followed. In actual practice, a 50% wirefill is the maximum amount of wiring the duct can hold given the additional airspace created between cables by non-uniform cable shapes, cable interlacing, and cable packing factors.

What is the Usable Duct Area?

The usable area we define as the calculation of internal area that can be occupied by wires or cables.

Calculation of Internal Area

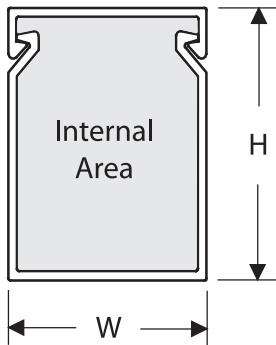

Since we use the outer channel dimensions in our calculation we make an adjustment in our formula for the thickness of material and for design elements that extend inside the channel.

Air Space Allotment

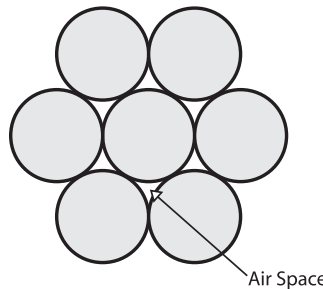

In our wirefill formula an adjustment is made to the channel internal area to account for “unusable” air space that will be present between cables when placed in the channel. Our formula assumes a uniform close packed or high density cable arrangement (see diagram)¹.

Considering these factors the usable duct area is equal to an average of 90% of the nominal area, or $(W \times H) \times .90$.

Wire Area

The wire area formula is converted to allow calculation using the cable diameter:

$$A_{\text{WIRE}} = \pi r^2$$

$$A_{\text{WIRE}} = (\pi/4) \times D^2$$

$$A_{\text{WIRE}} = .785 \times D^2$$

Formula Derivation

Inserting the elements from above into the general formula results in the following:

$$50\% \text{ Wirefill} = .50 \left(\frac{(W \times H) \times .90}{.785 \times D^2} \right)$$

Simplifying this formula results in the formula used for wire fill calculation²:

$$50\% \text{ Wirefill} = \left(\frac{W \times H}{1.75 \times D^2} \right)$$

Note: When calculating wirefill capacity using the above formula, variables W, H, and D must be expressed in same units (i.e. millimeters or inches).

¹ This calculation does not account for additional airspace created between cables by non-uniform cable shapes, cable interlacing, and cable packing factors.

² The resulting formula is used for all Panduit flush cover ducts, this excludes type HN, H, and HS wiring duct with a profile design that results in a divisor of $1.85 \times D^2$ (rather than $1.75 \times D^2$ as shown here).

NOTES

CABLE TIES AND ACCESSORIES

Panduit offers a full line of cable ties and cable management accessories to bundle, route, and identify cable in a variety of applications. With the most complete selection of cable tie and accessory products, Panduit provides innovative solutions to meet various application environments, customer needs, and industry standards.

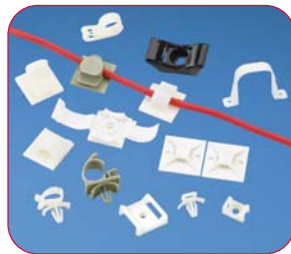

- Panduit cable ties are the safe choice for networking applications where performance integrity is critical; designs include a comprehensive line of hook and loop solutions, elastomeric cable ties, UL Listed solutions for plenum use, parallel-entry nylon ties designed to protect cable, and a variety of materials designed for extreme weatherability and strength
- Tak-Ty® Hook & Loop Cable Ties are available in various styles and designed for applications requiring cable safety and frequent moves, adds, and changes; Tak-Ty® Stacked Strip Cable Ties are available in convenient discrete length packaging to eliminate cutting ties to length
- Elastomeric Cable Ties are made of a network safe elastic material which has a flammability rating of UL 94V-0 to meet strict telecommunication specifications
- Panduit offers a comprehensive line of mounts, clips, and clamps that organize and route cables, speed and simplify installations, and lower overall installed cost; installation methods include adhesive backed, screws, and push barb
- Panduit mounts provide long term reliability while cable clips and clamps offer a one-piece solution to save time and reduce inventory

Panduit continues to solve customer problems and meet the needs of the evolving marketplace through the design of innovative cable tie and accessory products.

€ Tak-Ty® Hook & Loop Cable Ties

- Soft, premium material is safe to use on high performance network cables protecting against over-tensioning
- Broad selection of durable designs and sizes to meet your application needs
- Adjustable, releasable, and re-usable hundreds of times – ideal for applications requiring frequent moves, adds, or changes
- Easy to use and operator safe with no sharp edges
- A full range of colors
- Operating temperature range: 0°F to 220°F (-18°C to 104°C)
- Complementary mounts available



HLT (Loop Ties)



HLS (Strip Ties)



HLB (Stacked Strips)



HLM/HLS (Rolls)

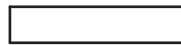

Part Number	Length		Width		Max. Bundle Dia.		Min. Loop Tensile Str.*		Std. Pkg. Qty.	Std. Ctn. Qty.
	In.	mm	In.	mm	In.	mm	Lbs.	N		

Loop Ties – Slot allows for pre-wrapping of bundles

HLT2I-X0	8.00	203.0	0.50	12.7	1.91	49.0	40	178	10	100
HLT3I-X0	12.00	305.0	0.50	12.7	3.18	81.0	40	178	10	100
HLT2I-M0	8.00	203.0	0.50	12.7	1.91	49.0	40	178	1	1
HLT3I-M0	12.00	305.0	0.50	12.7	3.18	81.0	40	178	1	1

Strip Ties – Perforated in convenient 6", 12", and 18" strips

HLS1.5S-X0	6.00	152.0	0.75	19.1	1.50	38.0	50	222	10	100
HLS3S-X0	12.00	305.0	0.75	19.1	3.20	81.0	50	222	10	100
HLS5S-X0	18.00	457.0	0.75	19.1	5.00	127.0	50	222	10	100

Stacked Strip Ties – Eliminates cutting ties to length and staging them for each job Rounded edges for installer safety – 100 pieces)

HLB2S-C0	7.00	178.0	0.75	19.1	1.60	41.0	50	222	1	10
-----------------	------	-------	------	------	------	------	----	-----	---	----

Part Number	Length		Width		Max. Bundle Dia.		Min. Loop Tensile Str.*		Std. Pkg. Qty.	Std. Ctn. Qty.
	Ft.	m	In.	mm	In.	mm	Lbs.	N		

15' and 75' Continuous Rolls – Can be cut to desired length, eliminating waste

HLM-15R0	15.0	4.6	0.33	8.4	Various	Various	40	80	1	10
HLS-15R0	15.0	4.6	0.75	19.1	Various	Various	50	222	1	10
HLS-75R0	75.0	22.9	0.75	19.1	Various	Various	50	222	1	10

For color options, reference hook and loop cable ties chart.
*Note: Minimum 2" overlap required to achieve loop tensile rating



HLTP/HLSP Hook and Loop Cable Ties – Plenum

- Soft, premium material is safe to use on high performance network cables protecting against over-tensioning
- UL Listed for use in plenum or air handling spaces (such as ceiling voids and underfloor areas) per NEC, Section 300-22 (C) and (D)
- Material flammability rating: UL 94V-2
- Adjustable, releasable, and re-usable multiple times – ideal for applications requiring frequent moves, adds, or changes
- Operating temperature range: 0°F – 122°F (-18°C – 50°C)



Part Number	Length		Width		Max. Bundle Dia.		Min. Loop Tensile Str.*		Std. Pkg. Qty.	Std. Ctn. Qty.
	In.	mm	In.	mm	In.	mm	Lbs.	N		

UL Listed Loop Ties (Maroon) – Slot allows for pre-wrapping of bundles

HLTP2I-X12	8.00	203.0	0.50	12.7	1.91	49.0	40	178	10	100
HLTP3I-X12	12.00	305.0	0.50	12.7	3.18	81.0	40	178	10	100

UL Listed Loop Ties (Black) – Slot allows for pre-wrapping of bundles

HLTP2I-X0	8.00	203.0	0.50	12.7	1.91	49.0	40	178	10	100
HLTP3I-X0	12.00	305.0	0.50	12.7	3.18	81.0	40	178	10	100

UL Listed Strip Ties (Maroon) – Perforated in convenient 6", 12", and 18" strips

HLSP1.5S-X12	6.00	152.0	0.75	19.1	1.50	38.0	50	222	10	100
HLSP3S-X12	12.00	305.0	0.75	19.1	3.20	81.0	50	222	10	100
HLSP5S-X12	18.00	457.0	0.75	19.1	5.00	127.0	50	222	10	100

UL Listed Strip Ties (Black) – Perforated in convenient 6", 12", and 18" strips

HLSP1.5S-X0	6.00	152.0	0.75	19.1	1.50	38.0	50	222	10	100
HLSP3S-X0	12.00	305.0	0.75	19.1	3.20	81.0	50	222	10	100
HLSP5S-X0	18.00	457.0	0.75	19.1	5.00	127.0	50	222	10	100

For color options, reference Hook & Loop cable ties chart.

*Note: Minimum 2" overlap required to achieve loop tensile rating.

CE Tak-Tape™ Hook & Loop Cable Tie Rolls

- Strong, low profile, flexible material is safe to use on high performance cabling protecting against over-tensioning
- Adjustable, releasable, and re-usable
- Cost-effective for general purpose bundling
- Continuous rolls can be easily cut to size – Panduit cutter included with TTS-35RX0
- Handy, re-usable plastic case with TTS-20R0, keeps material clean
- Leaves no residue
- Available in black color
- Operating temperature range: -22°F to 194°F (-30°C to 90°C)
- Complementary mounts available, see page P.39.



Part Number	Length		Width		Max. Bundle Dia.		Min. Loop Tensile Str.*		Std. Pkg. Qty.	Std. Ctn. Qty.
	Ft.	m	In.	mm	In.	mm	Lbs.	N		
TTS-20R0	20.0	6.1	0.75	19.1	Various	Various	40	178	1	10
TTS-35R3-0	35.0	10.7	0.75	19.1	Various	Various	40	178	1	8
TTS-35RX0	35.0	10.7	0.75	19.1	Various	Various	40	178	1	10

Std. Pkg. Qty. for TTS-35R3-0 is 1 pkg. of three 35' rolls, TTS-35RX0 is 1 pkg. of ten 35' rolls.

For color options, reference Hook & Loop cable ties chart.

*Note: Minimum 2" overlap required to achieve loop tensile rating.



€ Ultra-Cinch™ Hook & Loop Cable Ties

- Unique material with hooks and loops on same side allows user to secure a greater range of bundle diameters, including smaller bundles
- Soft, premium material is safe to use on high performance cabling, protecting against over-tensioning
- Adjustable, releasable, and re-usable hundreds of times – ideal for applications requiring frequent moves, adds, or changes
- Low profile contoured cinch ring provides extra strength and bundle tightness while reducing overall bundle size
- Grommet (UGCTC and UGCTE styles) offers strength and assures reliable installations that resist pullout when bundling and mounting cables within cabinet applications
- Tapered tip facilitates easy, snag-free threading to speed installation
- Use flat head screws for grommet applications shown below
- A full range of colors
- Operating temperature range: 0°F – 140°F (-18°C – 60°C)



Part Number	Length		Width		Max. Bundle Dia.		Min. Loop Tensile Str.*		Std. Pkg. Qty.	Std. Ctn. Qty.
	In.	mm	In.	mm	In.	mm	Lbs.	N		

Cinch Ties

UCT3S-X0	12.00	305.0	0.85	21.6	3.00	76.0	50	222	10	100
UCT5S-X0	18.00	457.0	0.85	21.6	5.00	127.0	50	222	10	100

Cinch Ties

UGCTC3S-X0	12.00	305.0	0.85	21.6	3.00	76.0	50	222	10	100
UGCTC5S-X0	18.00	457.0	0.85	21.6	5.00	127.0	50	222	10	100

Cinch Ties

UGCTE3S-X0	12.00	305.0	0.85	21.6	3.00	76.0	50	222	10	100
UGCTE5S-X0	18.70	475.0	0.85	21.6	5.00	127.0	50	222	10	100

Note: 1/4" (6mm) diameter mounting hole on grommet style cinch ties.

For color options, reference Hook & Loop cable ties chart.

*Note: Minimum 2" overlap required to achieve loop tensile rating

Flat Head Screws for Grommet Cinch Ties

Part Number	Part Description	Std. Pkg. Qty.	Std. Ctn. Qty.
UCTGS1224-X	12-24 UNC x 5/8" flat head Phillips screw.	10	100
UCTGSM5-X	M5 x 16mm flat head Phillips screw.	10	100
UCTGSM6-X	M6 x 16mm flat head Phillips screw.	10	100



NEW! Tape-Ty™ Hook & Loop Cable Ties

- Ultra-thin materials provide a low-profile, flexible construction
- Non-slip applicator prevents lateral movement of tie and allows tighter fastening of cable bundle
- Leaves no residue and is safe to use on high-performance cabling
- Pre-cut ties eliminate cutting ties to length and staging them for each job
- Adjustable, releasable, and reusable
- Available in black



Part Number	Length		Width		Max. Bundle Dia.		Min. Loop Tensile Str.*		Std. Pkg. Qty.	Std. Ctn. Qty.
	In.	mm	In.	mm	In.	mm	Lbs.	N		

25 Ties on Core-Less Reel

HLTT1.5S-Q20	7.00	177.8	0.75	19.1	1.50	38.1	30	133	1	10
---------------------	------	-------	------	------	------	------	----	-----	---	----

100 Ties on Core-Less Reel

HLTT1.5S-C20	7.00	177.8	0.75	19.1	1.50	38.1	30	133	1	10
---------------------	------	-------	------	------	------	------	----	-----	---	----

For color options, reference Hook & Loop cable ties chart.

*Note: Minimum 2" overlap required to achieve loop tensile rating

Cable Bundle Organizing Tool

- Reduces cable installation time up to 50% compared to traditional methods
- Arranges 24 cables prior to applying Panduit® Tak-Ty® Hook & Loop Cable Ties
- Optimizes bundle size and improves installed appearance
- Two inserts handle multiple network cable diameters
- Unique design allows twist-free bundling from the end or the middle of bundle
- Smooth edges; safe for use on network cables preventing cable abrasion
- Ergonomic fit and compact design
- Impact resistant material and low friction design to glide smoothly across cable bundle



Part Number	Description	Insert Color	Cable Diameter Range		Std. Pkg. Qty.	Std. Ctn. Qty.
			In.	mm		
CBOT24K	Kit contains jacket cover with hook and loop fastener and two inserts.	Fluorescent Green	0.18 – 0.25	4.6 – 6.3	1	10
		Fluorescent Yellow	0.23 – 0.31	5.8 – 7.9		

A. System Overview

B. Copper Systems

C. Fiber Optic Systems

D. Power over Ethernet

E. Zone Cabling

F. Wireless

G. Outlets

H. Media Distribution

I. Physical Infrastructure Management

J. Overhead & Underfloor Routing

K. Surface Raceway

L. Cabinets, Racks & Cable Management

M. Grounding & Bonding

N. Industrial

O. Labeling & Identification

P. Cable Management Accessories

Q. Index

Part Number System for Tak-Ty® Hook & Loop Cable Ties

HLT	2	I	—	X	0
Type	Size	Cross Section		Package Size	Color
HL = Hook and Loop HLB = Hook and Loop Stacked Strip HLM = HL Miniature HLT = HL Loop Tie HLTP = HL Loop Tie Plenum-Rated HLS = HL Strip Tie HLSP = HL Strip Tie Plenum-Rated TTS = Tak-Tape™ Roll HLTT = Hook and Loop with non-slip applicator	Approx. Maximum Bundle Dia. (In.)	M = Miniature I = Intermediate S = Standard		X = 10 Q = 25 C = 100 M = 1000 15R = 15' Roll 20R = 20' Roll 35R3 = 35' Rolls (3) 35RX = 35' Rolls (10) 75R = 75' Roll	See chart below

Part Number System for Ultra-Cinch™ Hook & Loop Cable Ties

UGCT	E	3	S	—	X	0
Type	Mount	Size	Cross Section		Package Size	Color
UCT = Cinch Tie UGCT = Grommet Cinch Tie	E = End Mount C = Center Mount	Approx. Maximum Bundle Dia. (In.)	I = Intermediate S = Standard		X = 10	See chart below

Color Chart

Color	Panduit Suffix	Color	Panduit Suffix
Black	0	Blue	6
Red	2	Gray	8
Orange	3	White	10
Yellow	4	Maroon	12
Green	5	Black (indoor)	20

Part Number Availability List

Standard Packaging	
Part Number	Color
HLB2S-C	0,2,3,4,5,6,8,10
HLM-15R	0,2,3,4,5,6,8,10
HLS-15R	0,2,3,4,5,6,8,10
HLS-75R	0,2,3,4,5,6,8,10
HLS1.5S-X	0,2,3,4,5,6,8,10
HLS3S-X	0,2,3,4,5,6,8,10
HLS5S-X	0,2,3,4,5,6,8,10
HLSP1.5S-X	0,12
HLSP3S-X	0,12
HLSP5S-X	0,12
HLT2I-X	0,2,3,4,5,6,8,10
HLT3I-X	0,2,3,4,5,6,8,10
HLTP2I-X	0,12
HLTP3I-X	0,12
HLTT1.5S-C	20
HLTT1.5S-Q	20
TTS-20R	0
TTS-35RX	0
TTS-35R3	0
UCT3S-X	0,2,3,4,5,6,8,10
UCT5S-X	0,2,3,4,5,6,8,10
UGCTC3S-X	0,2,3,4,5,6,8,10
UGCTC5S-X	0,2,3,4,5,6,8,10
UGCTE3S-X	0,2,3,4,5,6,8,10
UGCTE5S-X	0,2,3,4,5,6,8,10

ERT Elastomeric Cable Ties



- Elastic material provides a flexible tie body that safely contours around cable bundle, preventing over-tensioning of data cables to maintain network integrity
- UL 94V-0 material provides greater flame resistance; meets stringent telecommunication flammability requirements (such as NEBS GR-63-CORE)
- Soft material has no sharp edges; protects the installer and the cable bundle
- High coefficient of friction grips and prevents lateral movement along cable bundle
- Releasable and re-usable to accommodate frequent moves, adds, and changes
- Halogen-free, non-toxic, and environmentally safe material will not release toxic or corrosive gases upon combustion
- Locking head design; the tapered tip threads into locking head to speed productivity; industry-accepted intuitive tie design

Part Number	Length		Width		Thickness		Max. Bundle Dia.		Min. Loop Tensile Str.		Recommended Installation Tool	Std. Pkg. Qty.	Std. Ctn. Qty.
	In.	mm	In.	mm	In.	mm	In.	mm	Lbs.	N			
ERT2M-C20	8.50	216.0	0.50	12.7	0.09	2.3	2.35	59.7	18	80	Hand install only	100	1000
ERT3M-C20	11.00	279.0	0.50	12.7	0.09	2.3	3.00	76.2	18	80	Hand install only	100	1000
ERT4.5M-C20	16.00	406.0	0.50	12.7	0.09	2.3	4.50	114	18	80	Hand install only	100	1000

Part Number System for Elastomeric Cable Ties

ERT

Type

ERT = Elastomeric Releasable Tie

2

Size

Approx. Maximum Bundle Dia. (In.)

M

Cross Section

M = Miniature

—

C

Package Size

C = 100

—

Material/Color

See chart below

Material and Color Chart

Material	Color	Panduit Suffix
TPU	Black	20



Contour-Ty® Cable Ties – Nylon 6.6



- Unique design prevents wire and cable damage
- Low profile head avoids snags and reduces overall bundle size
- Outside teeth and smooth round edges protect cable jacket – ideal for high vibration applications
- Parallel-entry limits exposure to sharp edges and protects workers' arms/hands
- Fully enclosed head for consistent strength
- Curved tip is easy to pick up from flat surfaces and allows faster initial threading to speed installation



Part Number	Length		Width		Thickness		Max. Bundle Dia.		Min. Loop Tensile Str.		Recommended Installation Tool	Bulk Pkg. Qty.	Bulk Ctn. Qty.
	In.	mm	In.	mm	In.	mm	In.	mm	Lbs.	N			
Miniature Cross Section – Plenum-Rated													
CBR1M-M	4.1	104	0.098	2.5	0.038	1.0	1.00	25	18	80	GTS, GTSL, GS2B, PTS, PPTS, STS2	1000	50000
CBR1.5M-M	5.6	142	0.098	2.5	0.042	1.1	1.50	38	18	80		1000	50000
CBR2M-M	7.2	183	0.098	2.5	0.042	1.1	2.00	51	18	80		1000	25000
Intermediate Cross Section – Plenum-Rated													
CBR1.5I-M	5.9	150	0.140	3.6	0.040	1.0	1.50	38	40	178	GTS, GTSL, GS2B, PTS, PPTS, STS2	1000	25000
CBR3I-M	10.4	264	0.140	3.6	0.052	1.3	3.00	76	40	178		1000	10000
CBR4I-M	13.6	345	0.140	3.6	0.052	1.3	3.6	102	40	178		1000	10000
Standard Cross Section – Plenum-Rated													
CBR2S-M	7.6	193	0.190	4.8	0.044	1.1	2.00	51	50	222	GTS, GTSL, GS2B, GTH, GS4H, PTS, PTH, PPTS, STS2, STH2	1000	10000
CBR3S-M	10.8	274	0.190	4.8	0.052	1.3	3.00	76	50	222		1000	5000
CBR4S-M	14.0	356	0.190	4.8	0.052	1.3	4.00	102	50	222		1000	5000
Heavy-Standard Cross Section – Plenum-Rated													
CBR2HS-D	8.0	203	0.250	6.4	0.058	1.4	2.00	51	85	378	GTH, GS4H, GS4EH, PTH, STH2, ST3EH	500	5000
Light-Heavy Cross Section – Plenum-Rated													
CBR4LH-TL	14.6	371	0.300	7.6	0.070	1.8	7.6	102	120	534	GTH, GS4H, GS4EH, PTH, STH2, ST3EH	250	2500
CBR6LH-C	20.9	531	0.300	7.6	0.070	1.8	6.00	152	120	534		100	2000

Part Number System for Contour-Ty® Cable Ties

CBR

Type

CBR = Locking Tie

2

Size

Approx.
Maximum
Bundle
Dia. (In.)

S

Cross Section

M = Miniature
I = Intermediate
S = Standard
HS = Heavy-Standard
LH = Light-Heavy

—

M

Package Size

C = 100
TL = 250
D = 500
M = 1000

—

Material/Color

See chart
below

Material and Color Chart

Material	Color	Panduit Suffix
Nylon 6.6	Natural	✓
Weather Resistant Nylon 6.6	Black	0
Nylon 6.6	Brown	1
Nylon 6.6	Red	2
Nylon 6.6	Orange	3
Nylon 6.6	Yellow	4Y
Nylon 6.6	Green	5

Material	Color	Panduit Suffix
Nylon 6.6	Blue	6
Nylon 6.6	Purple	7
Nylon 6.6	Gray	8
Nylon 6.6	White	10
Heat Stabilized Nylon 6.6	Black	30
Heat Stabilized Nylon 6.6	Natural	39
Flame Retardant Nylon 6.6	Natural (Ivory)	69

✓Denotes Panduit Natural Nylon 6.6 (no suffix required).

Part Number Availability List

Bulk Packaging		
Part Number	Natural Nylon 6.6	Material/Color Suffix
CBR1M-M	✓	0,30
CBR1.5M-M	✓	0
CBR2M-M	✓	0,1,2,3,4Y,5,6,7
CBR1.5I-M	✓	0,30
CBR3I-M	✓	0,1,2,3,4Y,5,6,7,8,10
CBR4I-M	✓	0
CBR2S-M	✓	0,30,39
CBR3S-M	✓	0,30,69
CBR4S-M	✓	0,30
CBR2HS-D	✓	0
CBR4LH-TL	✓	0,30
CBR6LH-C	✓	0,30

UL US LISTED CE SF US Pan-Ty® Cable Ties – Nylon 6.6

- Versatile cable ties can be used in countless applications
- One-piece construction for consistent performance and reliability
- Lowest threading force of any one-piece cable tie in the industry
- Curved tip is easy to pick up from flat surfaces and allows faster initial threading to speed installation
- A variety of materials and colors available for specific applications
- UL Listed for use in plenum or air handling spaces per NEC except PLT.6SM and PLT5H/6H/8H/13H, PLT5EH/6EH



EH Series

Part Number	Length		Width		Thickness		Max. Bundle Dia.		Min. Loop Tensile Str.		Recommended Installation Tool	Std. Pkg. Qty.	Std. Ctn. Qty.
	In.	mm	In.	mm	In.	mm	In.	mm	Lbs.	N			

Miniature Cross Section – Plenum-Rated

PLT1M-C	3.9	99	0.098	2.5	0.043	1.1	0.87	22	18	80	GTS, GTSL, GS2B, PTS, PPTS, STS2	100	1000
PLT1.5M-C	5.6	142	.098	2.5	0.043	1.1	2.5	32	18	80		100	1000
PLT2M-C	8.0	203	.098	203	0.043	1.1	2.00	51	18	80		100	1000

Intermediate Cross Section – Plenum-Rated

PLT1.5I-C	5.6	142	.142	3.6	0.045	1.1	1.38	35	40	178	GTS, GTSL, GS2B, PTS, PPTS, STS2	100	1000
PLT2I-C	8.0	203	.142	3.6	0.045	1.1	2.00	51	40	178		100	1000
PLT2.5I-C	9.7	246	.145	3.7	0.052	1.3	2.50	64	40	178		100	1000
PLT3I-C	11.4	290	.145	3.7	0.052	1.3	3.00	76	40	178		100	1000
PLT4I-C	14.5	368	.145	3.7	0.052	1.3	4.00	102	40	178		100	1000

Standard Cross Section – Plenum-Rated

PLT1S-C	4.8	122	.190	4.8	0.052	1.3	1.00	25	50	222	GTS, GTSL, GS2B, GTH, GS4H, PTS, PPTS, PTH, STS2, STH2	100	1000
PLT1.5S-C	6.2	157	.190	4.8	0.052	1.3	1.50	38	50	222		100	1000
PLT2S-C	7.4	188	.190	4.8	0.052	1.3	1.88	48	50	222		100	1000
PLT2.5S-C	9.8	249	.190	4.8	0.052	1.3	2.50	64	50	222		100	1000
PLT3S-C	11.5	292	.190	4.8	0.052	1.3	3.00	76	50	222		100	1000
PLT4S-C	14.5	368	.190	4.8	0.052	1.3	4.00	102	50	222		100	1000
PLT4.5S-C	15.5	394	.190	4.8	0.052	1.3	4.50	114	50	222		100	1000
PLT5S-C	17.5	445	.190	4.8	0.052	1.3	5.00	127	50	222	100	500	

Light-Heavy Cross Section (Straight Tip) – Plenum-Rated

PLT2H-L	8.1	206	.300	7.6	0.075	1.9	2.00	51	120	534	GTH, GS4H, GS4EH, PTH, STH2, ST3EH	50	500
PLT2.5H-L	9.8	251	.300	7.6	0.075	1.9	2.50	64	120	534		50	500
PLT3H-L	11.4	290	.300	7.6	0.075	1.9	3.00	76	120	534		50	500
PLT4H-L	14.5	368	.300	7.6	0.075	1.9	4.00	102	120	534		50	500
PLT6LH-L	21.9	556	.300	7.6	0.075	1.9	6.00	152	120	534		50	500
PLT7LH-L	24.7	627	.300	7.6	0.075	1.9	7.00	178	120	534		50	500
PLT8LH-L	27.6	701	.300	7.6	0.075	1.9	8.00	203	120	534		50	500
PLT9LH-L*	30.5	775	.300	7.6	0.075	1.9	9.00	229	120	534		50	500
PLT10LH-L*	34.3	871	.300	7.6	0.075	1.9	10.31	262	120	534		50	1000

Heavy Cross Section (Straight Tip)

PLT5H-L*	17.7	450	.350	450	0.078	2.0	5.00	127	175	778	GTH, GS4H, GS4EH, PTH, STH2, ST3EH	50	500
PLT6H-L*	20.9	530	.350	8.9	0.078	2.0	6.00	152	175	778		50	500
PLT8H-L*	30.6	779	.350	8.9	0.078	2.0	9.00	229	175	778		50	500
PLT13H-Q*	43.3	1100	.350	8.9	0.078	2.0	13.00	330	175	778		25	500

Extra-Heavy Cross Section (Straight Tip)

PLT5EH-Q	20.1	511	0.500	12.7	0.075	1.9	5.00	127	250	1112	GS4EH, ST3EH	25	250
PLT6EH-Q	22.2	564	0.500	12.7	0.075	1.9	6.00	152	250	1112		25	250

*UL Listed – meets the requirements of UL 181B-C, for use with UL non-metallic air ducts and air connectors.
UL Recognized except PLT5EH/6EH.



Pan-Ty® Cable Ties – HALAR[▲] – Distinctive Maroon Color

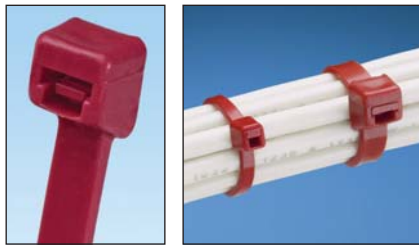

- UL Listed for use in plenum or air handling spaces per NEC, Section 300-22 (C) and (D)
- Low smoke density and excellent flammability rating of UL 94V-0
- Commonly accepted solution for bundling qualified cable without conduit in air handling space applications
- Curved tip is easy to pick up from flat surfaces and allows faster initial threading to speed installation



Part Number	Length		Width		Thickness		Max. Bundle Dia.		Min. Loop Tensile Str.		Recommended Installation Tool	Std. Pkg. Qty.	Std. Ctn. Qty.
	In.	mm	In.	mm	In.	mm	In.	mm	Lbs.	N			
Miniature Cross Section – Plenum-Rated													
PLT1M-C702Y	4.0	102	.098	2.5	.043	1.1	2.5	22	18	80	GTS, GTSL, GS2B, PTS, PPTS, STS2	100	1000
Standard Cross Section – Plenum-Rated													
PLT2S-C702Y	7.4	188	.190	4.8	.055	1.4	1.88	48	50	222	GTS, GTSL, GS2B, GTH, GS4H, PTS, PTH, PPTS, STS2, STH2	100	1000
PLT3S-C702Y	11.6	295	.190	4.8	.055	1.4	3.00	76	50	222		100	1000

▲HALAR is a registered trademark of Solvay Solexis, Inc.



Pan-Ty® Clamp Ties – Nylon 6.6

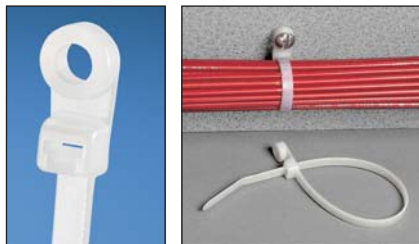

- Used to secure a cable bundle to another surface such as a control panel, communication rack, wall, or ceiling
- Design allows for bundling before or after screwing clamp in place
- One-piece construction for consistent performance and reliability
- Curved tip is easy to pick up from flat surfaces and allows faster initial threading to speed installation



Part Number	Length		Width		Thickness		Nominal Hole Dia.		Screw Size	Screw Size Metric	Max. Bundle Dia.		Min. Loop Tensile Str.		Recommended Installation Tool	Std. Pkg. Qty.	Std. Ctn. Qty.
	In.	mm	In.	mm	In.	mm	In.	mm			In.	mm	Lbs.	N			
Miniature Cross Section – Plenum-Rated																	
PLC1M-S4-C	4.3	109	0.100	2.5	0.045	1.1	0.122	3.1	#4	M2.5	0.75	19	18	80	GTS, GTSL, GS2B, PTS, PPTS, STS2	100	1000
Intermediate Cross Section – Plenum-Rated																	
PLC1.5I-S8-C	6.1	155	0.135	3.4	0.045	1.1	0.174	4.4	#8	M4	1.25	32	40	178	GTS, GTSL, GS2B, PTS, PPTS, STS2	100	1000
Standard Cross Section – Plenum-Rated																	
PLC2S-S6-C	7.9	201	0.190	4.8	0.047	1.2	0.148	3.8	#6	M3	1.84	47	50	222	GTS, GTSL, GS2B, GTH, GS4H, PTS, PTH, PPTS, STS2, STH2	100	1000
PLC2S-S10-C	7.9	201	0.190	4.8	0.047	1.2	0.200	5.1	#10	M5	1.84	47	50	222		100	1000
PLC3S-S10-C	12.0	305	0.190	4.8	0.052	1.3	0.200	5.1	#10	M5	3.00	76	50	222		100	1000
PLC4S-S10-C	15.0	381	0.190	4.8	0.052	1.3	0.200	5.1	#10	M5	4.00	102	50	222		100	1000
Light-Heavy Cross Section – Plenum-Rated																	
PLC2H-S25-L	9.0	229	0.300	7.6	0.075	1.9	0.260	6.6	1/4	M6	2.00	51	120	534	GTH, GS4H, GS4EH, PTH, STH2, ST3EH	50	500
PLC4H-S25-L	15.1	384	0.300	7.6	0.075	1.9	0.260	6.6	1/4	M6	4.00	102	120	534		50	500

Pan-Ty® Marker and Flag Ties – Nylon 6.6

- Used to fasten and identify bundles at the same time
- One-piece construction for consistent performance and reliability
- Can be marked with Panduit marker pens or custom imprinted using Panduit Custom Hot Stamping Service (see page P.38)
- Curved tip is easy to pick up from flat surfaces and allows faster initial threading to speed installation

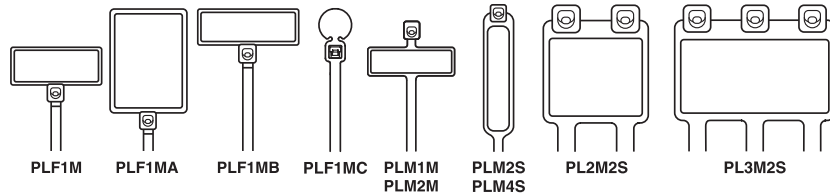
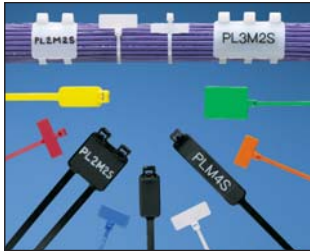

Part Number	Marker Type	Length		Width		Thickness		Marker Write-On Area		Max. Bundle Dia.		Min. Loop Tensile Str.		Recommended Installation Tool	Std. Pkg. Qty.	Std. Ctn. Qty.
		In.	mm	In.	mm	In.	mm	In.	mm	In.	mm	Lbs.	N			

Miniature Cross Section

PLF1M-C	Flag	4.3	109	.098	2.5	.045	1.1	.31 x .75	7.9 x 19.1	.87	22	18	80	GTS, GTSL, GS2B, PTS, PPTS, STS2	100	1000
PLF1MA-C	Flag	5.1	130	.098	2.5	.045	1.1	.76 x 1.04	19.1 x 26.4	.87	22	18	80		100	1000
PLF1MB-C	Flag	4.0	101	.098	2.5	.045	1.1	.31 x .92	7.9 x 23.4	.75	19	18	80		100	1000
PLF1MC-M	Flag	4.3	109	.098	2.5	.045	1.1	2.5	7.9 x 19.1	.87	22	18	80		100	1000
PLM1M-C	Wrap	3.9	99	.098	2.5	.035	.9	.26 x .95	6.6 x 24.1	.75	19	18	80		100	1000
PLM2M-C	Wrap	8.0	203	.098	2.5	.035	.9	.26 x .95	6.6 x 24.1	2.00	51	18	80		100	1000

Standard Cross Section

PLM2S-C	Wrap	7.4	188	.185	4.7	.052	1.3	.44 x .87	11.1 x 22.1	1.75	45	50	222	GTS, GTSL, GS2B, GTH, GS4H, PTS, PTH, PPTS, STS2, STH2	100	1000
PLM4S-C	Wrap	14.6	371	.185	4.7	.052	1.3	.44 x 2.00	11.1 x 50.8	4.00	102	50	222		100	1000
PL2M2S-L	Wrap	7.4	188	.185	4.7	.052	1.3	.87 x 1.07	22.1 x 27.2	1.75	45	50	222		50	500
PL3M2S-L	Wrap	7.4	188	.185	4.7	.052	1.3	.87 x 1.79	22.1 x 45.5	1.75	45	50	222		50	500

Permanent Marking Pens

- Fast drying, permanent ink for identification on marker ties shown above



PX-0
PX-2



PFX-0
PFX-2

Part Number	Color	Description	Std. Pkg. Qty.	Std. Ctn. Qty.
PX-0	Black	Permanent marking pen – regular tip.	12	144
PX-2	Red	Permanent marking pen – regular tip.	12	144
PFX-0	Black	Permanent marking pen – fine tip.	12	144
PFX-2	Red	Permanent marking pen – fine tip.	12	144

Part Number System for Pan-Ty® Cable Ties

PLT	2	S		—	C	
Type	Size	Cross Section	Screw Hole Size	Package Size	Material/Color	
PLT = Locking Tie	Approx. Maximum Bundle Dia. (In.)	SM = Subminiature M = Miniature I = Intermediate S = Standard LH = Light-Heavy H = Heavy EH = Extra-Heavy	(Clamp Ties Only) -S4 = #4 (M2.5) -S6 = #6 (M3) -S8 = #8 (M4) -S10 = #10 (M5) -S25 = 1/4 (M6)	Q = 25 L = 50 C = 100 TL = 250 D = 500 M = 1000	See chart below	

Material and Color Chart

Material	Color	Panduit Suffix
Nylon 6.6	Natural	✓
Weather Resistant Nylon 6.6	Black	0
Weather Resistant Nylon 6.6 (meets Mil. Spec.)	Black	00
Nylon 6.6	Brown	1
Nylon 6.6	Red	2
Nylon 6.6	Orange	3
Nylon 6.6	Yellow	4Y
Nylon 6.6	Green	5
Nylon 6.6	Blue	6
Nylon 6.6	Purple	7
Nylon 6.6	Gray	8
Nylon 6.6	White	10
Nylon 6.6	Telephone Gray	14
Nylon 6.6	Black	20
Heat Stabilized Nylon 6.6	Black	30

Material	Color	Panduit Suffix
Heat Stabilized Nylon 6.6	Natural	39
Nylon 6.6	Fluorescent Orange	53
Nylon 6.6	Fluorescent Yellow	54
Nylon 6.6	Fluorescent Green	55
Nylon 6.6	Fluorescent Pink	59
Flame Retardant Nylon 6.6	Black	60
Flame Retardant Nylon 6.6	Natural (Ivory)	69
PEEK (Polyetheretherketone)	Translucent Brown	71
TEFZEL*	Aqua Blue	76
Metal Detectable Nylon	Blue	86
Metal Detectable Polypropylene	Blue	186
Weather Resistant Polypropylene	Black	100
Polypropylene	Green	109
Nylon 12	Black	120
Heat Stabilized Weather Resistant Nylon 6.6	Black	300
HALAR*	Maroon	702Y

✓ Denotes Panduit Natural Nylon 6.6 (no suffix).
 *TEFZEL is a registered trademark of E.I. du Pont de Nemours and Company.
 *HALAR is a registered trademark of Ausimont USA, Inc.

Part Number Availability List

Standard Packaging			Bulk Packaging		
Part Number	Natural Nylon 6.6	Material/Color Suffix	Part Number	Natural Nylon 6.6	Material/Color Suffix
PLC1M-S4-C	✓	0	PLC1M-S4-M	✓	0,30
PLC1.5I-S8-C	✓	0	PLC1.5I-S8-M	✓	0,30
PLC2S-S6-C	✓	0	PLC2S-S6-M	✓	0
PLC2S-S10-C	✓	0,14	PLC2S-S10-M	✓	0,20,30
PLC3S-S10-C	✓	0	PLC3S-S10-M	✓	0
PLC4S-S10-C	✓	0	PLC4S-S10-M	✓	0,30
PLC2H-S25-L	✓		PLC2H-S25-TL	✓	0,30
PLC4H-S25-L	✓	0	PLC4H-S25-TL	✓	0,30
PLF1M-C	✓	0	PLF1M-M	✓	0,2,3,4Y,6,10,69
PLF1MA-C	✓	3,4Y	PLF1MA-M	✓	0,2,3,4Y,5,6,10
PLF1MB-C	✓		PLF1MB-M	✓	
			PLF1MC-M		3
PLM1M-C	✓	0	PLM1M-M	✓	0,1,2,3,4Y,5,6,7,8,10,69
PLM2M-C	✓		PLM2M-M	✓	0,4Y,6
PLM2S-C	✓	0,4Y	PLM2S-D	✓	0,2,3,4Y,5,6,8
PLM4S-C	✓		PLM4S-D	✓	0,2,4Y,6

Pan-Ty[®] Cable Ties (continued)

Standard Packaging			Bulk Packaging		
Part Number	Natural Nylon 6.6	Material/Color Suffix	Part Number	Natural Nylon 6.6	Material/Color Suffix
PL2M2S-L	✓	0	PL2M2S-D	✓	0,4Y,10
PL3M2S-L	✓		PL3M2S-D	✓	0,4Y
PLT.6SM-C	✓	0	PLT.6SM-M	✓	0,30
PLT.7M-C	✓		PLT.7M-M	✓	0,30
PLT1M-C	✓	0,00,1,2,3,4Y,5,6,7,8,10,14,30,76,86,186,702Y	PLT1M-M	✓	0,00,1,2,3,4Y,5,6,7,8,10,14,20,30,53,54,55,59,60,69,76,100,109,300,702Y
PLT1.5M-C	✓	0	PLT1M-XMR	✓	0,1,2,3,4Y,5,6,7,8,10,30
			PLT1.5M-M	✓	0,00,1,2,3,4Y,5,6,7,8,10,14,20,30
			PLT1.5M-XMR	✓	0,00,30
PLT2M-C	✓	0	PLT2M-M	✓	0,1,2,3,4Y,5,6,7,8,10,20,30,69
PLT1.5I-C	✓	0,1,2,3,4Y,5,6,7,8,10,20,30	PLT1.5I-M	✓	0,00,1,2,3,4Y,5,6,7,8,10,20,30,69,100,109,120,300
PLT2I-C	✓	0,14,30,76,86,186	PLT2I-M	✓	0,00,1,2,3,4Y,5,6,7,8,10,14,20,30,53,54,55,59,69,76,300
PLT2.5I-C	✓	0	PLT2.5I-M	✓	0,20
PLT3I-C	✓	0,14	PLT3I-M	✓	0,2,3,4Y,5,6,8,10,14,20,30
PLT4I-C	✓	0,14	PLT4I-M	✓	0,2,5,6,14,20,30
PLT1S-C	✓	0	PLT1S-M	✓	0,30,38,300
PLT1.5S-C	✓	0	PLT1.5S-M	✓	0,30
PLT2S-C	✓	0,00,1,2,3,4Y,5,6,7,8,10,20,30,71,76,86,702Y	PLT2S-M	✓	0,00,1,2,3,4Y,5,6,7,8,10,20,30,38,39,53,54,55,59,60,69,71,76,100,109,120,300,702Y
			PLT2S-VMR	✓	0,30
PLT2.5S-C	✓	0	PLT2.5S-M	✓	0,30
PLT3S-C	✓	0,00,2,20,30,76,86,186,702Y	PLT3S-M	✓	0,00,1,2,3,4Y,5,6,7,8,10,20,30,53,54,55,59,76,100,109,702Y
PLT4S-C	✓	0,00,2,3,4Y,5,6,8,20,30,76,86,186	PLT4S-M	✓	0,00,1,2,3,4Y,5,6,7,8,10,14,20,30,69,76,100,109,120,300
PLT4.5S-C	✓	0	PLT4.5S-M	✓	0
PLT5S-C	✓	0	PLT5S-M	✓	0,2,3,4Y,5,6,8,30
PLT6LH-L	✓	0	PLT6LH-C	✓	0
PLT7LH-L	✓	0	PLT7LH-C	✓	0,30
PLT8LH-L	✓	0	PLT8LH-C	✓	0,120
PLT8LH-Q		0			
PLT9LH-L	✓	0	PLT9LH-C	✓	0,30
PLT10LH-L	✓		PLT10LH-C	✓	
PLT2H-L	✓	0	PLT2H-TL	✓	0,2,4Y,6,30,100,109,300
PLT2.5H-L	✓	0	PLT2.5H-TL	✓	0
PLT3H-L	✓	0,76,86,186	PLT3H-TL	✓	0,30,76,100,109
PLT4H-L	✓	0,00,76,86,186	PLT4H-TL	✓	0,00,1,2,3,4Y,5,6,10,20,30,69,76,100,109,120,300
PLT4H-C	✓	0			
PLT5H-L	✓	0	PLT5H-C	✓	0,30
PLT6H-L	✓	0	PLT6H-C	✓	0,30
PLT8H-L	✓	0	PLT8H-C	✓	0,00,30
PLT8H-L	✓	0			
PLT13H-Q	✓	0	PLT13H-C	✓	0,3
PLT2EH-Q		0	PLT2EH-C	✓	0
			PLT3EH-NB-C		0
PLT5EH-Q	✓	0	PLT5EH-C	✓	0
			PLT5EH-NB-C		0
PLT6EH-Q	✓	0	PLT6EH-C	✓	0
			PLT6EH-NB-C		0
PLT8EH-Q		0	PLT8EH-C	✓	0
PLT10EH-Q		0	PLT10EH-C	✓	0
PLT12EH-Q		0	PLT12EH-C	✓	0

⊂ ⊂ Dura-Ty™ Cable Ties – Weather Resistant Acetal – Heavy Cross Section

- Ideal for securing cables in outdoor messenger strand applications
- Black acetal strap and head material provide 20+ years outdoor life and high impact resistance
- Excellent ultraviolet light, chemical, and moisture resistance



- Double stainless steel locking barbs provide consistent and predictable holding values
- Convenient reel dispenser pack allows installer to cut-to-size for customized field applications; recyclable box has through-hole for attaching to belt, plus storage area for bag of heads; see formula box (below) to calculate amount of strapping required
- Textured strap provides better gripping surface
- Robust head design allows tie to be tightened over a wide range of angles

Part Number	Description	Strap Length		Strap Width		Min. Loop Tensile Str.		Head Height		Head Width		Recommended Installation Tool	Std. Pkg. Qty.	Std. Ctn. Qty.
		Ft.	m	In.	mm	Lbs.	N	In.	mm	In.	mm			
Strapping, Heads, and Kit – Allows user to customize strap length														
DTRH-LRO	50' reel of strapping.	50.0	15.2	.331	8.40	200	890	—	—	—	—	GTH, GS4EH, STH2, STHV, ST3EH	1	20
DTHH-QO	25 cable tie heads.	—	—	—	—	—	—	.393	9.98	.557	.557	—	25	500
DTKH-O	Kit: strapping (50'), heads (25).	50.0	15.2	.331	8.40	200	890	.393	9.98	.557	.557	GTH, GS4EH, STH2, STHV, ST3EH	1	20

⊂ ⊂ Dura-Ty™ Cable Ties – Weather Resistant Acetal – Extra-Heavy Cross Section

- Same features and benefits as shown in **Bolded** bullets (above) for Heavy cross section, plus:
- Meets Telcordia TR-TSY-000789

- Discrete lengths have lead-in style angled tips for quick and easy installation, even with gloved hands



Formula to determine amount of strapping required:
 Diameter (inches) x 3.14 + 4.5 inches
 Diameter (mm) x 3.14 + 114mm

Part Number	Description	Strap Length		Strap Width		Min. Loop Tensile Str.		Head Height		Head Width		Recommended Installation Tool	Std. Pkg. Qty.	Std. Ctn. Qty.
		Ft.	m	In.	mm	Lbs.	N	In.	mm	In.	mm			
Strapping, Heads, and Kit – Allows user to customize strap length														
DTREH-LRO	50' reel of strapping.	50.0	15.2	.500	12.70	250	1112	—	—	—	—	GS4EH, ST3EH	1	20
DTHEH-QO	25 cable tie heads.	—	—	—	—	—	—	.490	12.45	.718	18.24	—	25	500
DTKEH-O	Kit: strapping (50'), heads (25).	50.0	15.2	.500	12.70	250	1112	.490	12.45	.718	18.24	GS4EH, ST3EH	1	20

Part Number	Length		Width		Thickness		Head Height		Head Width		Max. Bundle Dia.		Min. Loop Tensile Str.		Recommended Installation Tool	Std. Pkg. Qty.	Std. Ctn. Qty.
	In.	mm	In.	mm	In.	mm	In.	mm	In.	mm	In.	mm	Lbs.	N			
Discrete Lengths – Speed installation																	
DT4EH-L0	13.5	343	.500	12.70	.059	1.50	.490	12.45	.718	18.24	3.8	98	250	1112	GS4EH, ST3EH	50	100
DT8EH-QO	27.0	686	.500	12.70	.059	1.50	.490	12.45	.718	18.24	8.0	203	250	1112		25	500
DT14EH-L0	48.0	1219	.500	12.70	.059	1.50	.490	12.45	.718	18.24	14.0	355	250	1112		50	250
DT15EH-L0	53.0	1346	.500	12.70	.059	1.50	.490	12.45	.718	18.24	15.0	381	250	1112		50	250
DT28EH-CO	96.0	2438	.500	12.70	.059	1.50	.490	12.45	.718	18.24	28.0	711	250	1112		100	—
DT44EH-CO	144.0	3658	.500	12.70	.059	1.50	.490	12.45	.718	18.24	44.0	1117	250	1112		100	—

Stackable Aerial Cable Spacer – Weather Resistant Polypropylene



- Designed for use in parallel or perpendicular applications
- For use with Dura-Ty™ Cable Ties shown on the previous page
- Each spacer snaps into another to increase spacer heights by 1/2 inch increments
- Greater resistance to damage caused by ultraviolet light – indoor or outdoor use

Part Number	Length		Width		Height		Used with Cable Ties*	Bulk Pkg. Qty.	Bulk Ctn. Qty.
	In.	mm	In.	mm	In.	mm			
SACS50-T100	2.08	52.8	1.16	29.5	.71	18.0	LH, H, EH	200	2000

*Cable tie cross section sizes: LH = Light-Heavy, H = Heavy, and EH = Extra-Heavy.

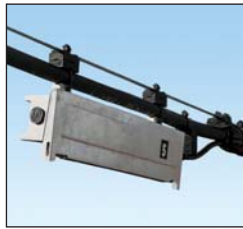

Aerial Support Ties – Weather Resistant Polypropylene

- Designed to attach coax or telephone cable to the 1/4 inch (6.4mm) or 5/16 inch (7.9mm) support strand to form the expansion loop and keep equipment and cables clear of pole hardware
- One-piece construction with integral 1/2 inch (12.7mm) spacer reduces inventory costs of separate spacer and bands, and installs faster to lower the installed cost
- Releasable and re-usable
- Hand install only



Part Number	Length		Width		Thickness		Max. Bundle Dia.		Min. Loop Tensile Str.		Std. Pkg. Qty.	Std. Ctn. Qty.
	In.	mm	In.	mm	In.	mm	In.	mm	Lbs.	N		
AST10-5-C100	5.6	142	.45	11.4	.06	1.4	1.00	25.4	75	334	100	1000
AST15-5-C100	6.9	175	.45	11.4	.06	1.4	1.50	38.1	75	334	100	1000
AST20-5-C100	8.4	214	.45	11.4	.06	1.4	2.00	50.8	75	334	100	1000
AST25-5-C100	10.0	254	.45	11.4	.07	1.8	2.50	63.5	75	334	100	1000

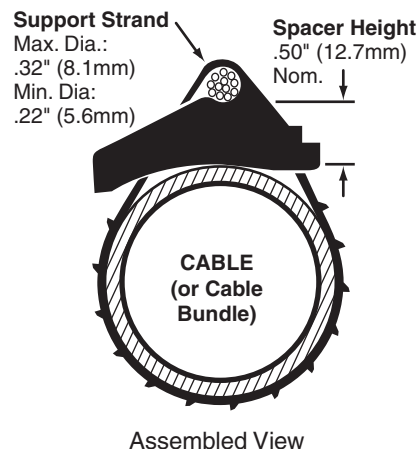

Part Number System for Dura-Ty® Cable Ties and Aerial Support Ties

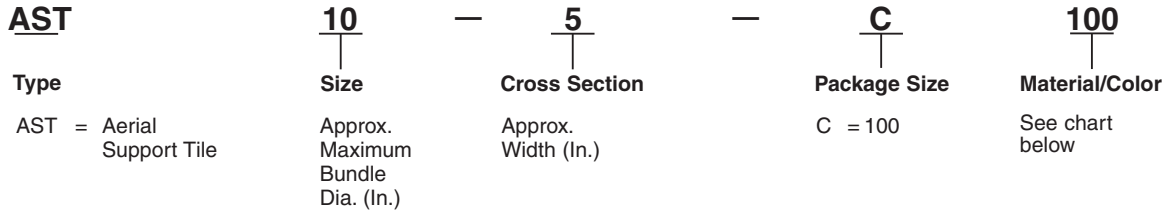
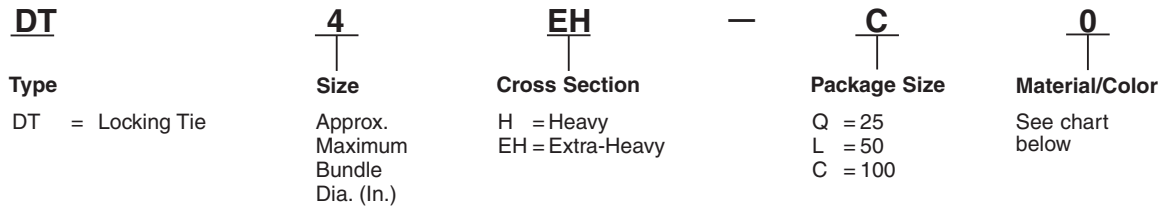

Material and Color Chart

Material	Color	Panduit Suffix
Weather Resistant Polypropylene	Black	100
Weather Resistant Acetal	Black	*

*Denotes Dura-Ty™ Weather Resistant Acetal material (no suffix).

Part Number Availability List

Standard Packaging			Bulk Packaging		
Part Number	Natural Nylon 6.6	Material/Color Suffix	Part Number	Natural Nylon 6.6	Material/Color Suffix
AST10-5-C		100			
AST15-5-C		100			
AST20-5-C		100			
AST25-5-C		100			
DTHEH-Q0		*			
DTHH-Q0		*			
DTKEH-0		*			
DTKH-0		*			
DTREH-LR0		*			
DTRH-LR0		*			
DT4EH-L0		*			
DT8EH-Q0		*			
DT14EH-L0		*	DT14EH-C0		*
DT15EH-L0		*			
DT28EH-C0		*			
DT44EH-C0		*			

*Denotes Dura-Ty™ Weather Resistant Acetal material (no suffix).

UL[®] US C E CE[®] SP[®] Pan-Ty[®] Striped Cable Ties – Nylon 6.6

- Nylon material for indoor use
- Striped Pan-Ty[®] Cable Ties in 25 color combinations match the universally accepted Even-Count Color Code
- Solid color ties are available for identification of “super groups” in cable containing more than 600 pairs
- Each 50 piece package fits in the Pan-Pouch™ Kit or pocket pouch shown on the next page (sold separately)

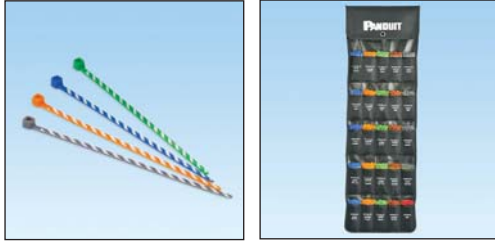

Part Number	Color	Length		Width		Thickness		Max. Bundle Dia.		Min. Loop Tensile Str.		Std. Pkg. Qty.	Std. Ctn. Qty.
		In.	mm	In.	mm	In.	mm	In.	mm	Lbs.	N		
PLT1M-L6-10	Blue/White Stripe	4.0	102	.100	2.5	.036	.9	.82	21	18	80	50	1000
PLT1M-L3-10	Orange/White Stripe	4.0	102	.100	2.5	.036	.9	.82	21	18	80	50	1000
PLT1M-L5-10	Green/White Stripe	4.0	102	.100	2.5	.036	.9	.82	21	18	80	50	1000
PLT1M-L1-10	Brown/White Stripe	4.0	102	.100	2.5	.036	.9	.82	21	18	80	50	1000
PLT1M-L8-10	Slate/White Stripe	4.0	102	.100	2.5	.036	.9	.82	21	18	80	50	1000
PLT1M-L6-2	Blue/Red Stripe	4.0	102	.100	2.5	.036	.9	.82	21	18	80	50	1000
PLT1M-L3-2	Orange/Red Stripe	4.0	102	.100	2.5	.036	.9	.82	21	18	80	50	1000
PLT1M-L5-2	Green/Red Stripe	4.0	102	.100	2.5	.036	.9	.82	21	18	80	50	1000
PLT1M-L1-2	Brown/Red Stripe	4.0	102	.100	2.5	.036	.9	.82	21	18	80	50	1000
PLT1M-L8-2	Slate/Red Stripe	4.0	102	.100	2.5	.036	.9	.82	21	18	80	50	1000
PLT1M-L6-0	Blue/Black Stripe	4.0	102	.100	2.5	.036	.9	.82	21	18	80	50	1000
PLT1M-L3-0	Orange/Black Stripe	4.0	102	.100	2.5	.036	.9	.82	21	18	80	50	1000
PLT1M-L5-0	Green/Black Stripe	4.0	102	.100	2.5	.036	.9	.82	21	18	80	50	1000
PLT1M-L1-0	Brown/Black Stripe	4.0	102	.100	2.5	.036	.9	.82	21	18	80	50	1000
PLT1M-L8-0	Slate/Black Stripe	4.0	102	.100	2.5	.036	.9	.82	21	18	80	50	1000
PLT1M-L6-4	Blue/Yellow Stripe	4.0	102	.100	2.5	.036	.9	.82	21	18	80	50	1000
PLT1M-L3-4	Orange/Yellow Stripe	4.0	102	.100	2.5	.036	.9	.82	21	18	80	50	1000
PLT1M-L5-4	Green/Yellow Stripe	4.0	102	.100	2.5	.036	.9	.82	21	18	80	50	1000
PLT1M-L1-4	Brown/Yellow Stripe	4.0	102	.100	2.5	.036	.9	.82	21	18	80	50	1000
PLT1M-L8-4	Slate/Yellow Stripe	4.0	102	.100	2.5	.036	.9	.82	21	18	80	50	1000
PLT1M-L6-7	Blue/Violet Stripe	4.0	102	.100	2.5	.036	.9	.82	21	18	80	50	1000
PLT1M-L3-7	Orange/Violet Stripe	4.0	102	.100	2.5	.036	.9	.82	21	18	80	50	1000
PLT1M-L5-7	Green/Violet Stripe	4.0	102	.100	2.5	.036	.9	.82	21	18	80	50	1000
PLT1M-L1-7	Brown/Violet Stripe	4.0	102	.100	2.5	.036	.9	.82	21	18	80	50	1000
PLT1M-L8-7	Slate/Violet Stripe	4.0	102	.100	2.5	.036	.9	.82	21	18	80	50	1000
PLT1M-L0	Black	4.0	102	.100	2.5	.036	.9	.82	21	18	80	50	1000
PLT1M-L1	Brown	4.0	102	.100	2.5	.036	.9	.82	21	18	80	50	1000
PLT1M-L2	Red	4.0	102	.100	2.5	.036	.9	.82	21	18	80	50	1000
PLT1M-L3	Orange	4.0	102	.100	2.5	.036	.9	.82	21	18	80	50	1000
PLT1M-L4Y	Yellow	4.0	102	.100	2.5	.036	.9	.82	21	18	80	50	1000
PLT1M-L5	Green	4.0	102	.100	2.5	.036	.9	.82	21	18	80	50	1000
PLT1M-L6	Blue	4.0	102	.100	2.5	.036	.9	.82	21	18	80	50	1000
PLT1M-L8	Slate	4.0	102	.100	2.5	.036	.9	.82	21	18	80	50	1000

Note: CSA Certified on solid colors only.

Telephone Cable Identification Kits



PPC25X50F



PP5X50F

- Pan-Pouch™ Kit is made of 2-ply laminated black nylon/vinyl and folds for easy storage
- Easily hang pouch from cable by using hook and loop fasteners
- Pocket pouch holds five (50-piece) packages and is made of a white vinyl

Part Number	Description	Dimensions		Std. Pkg. Qty.
		Open	Closed	
PPC25X50F	Pouch filled with 1,250 cable ties (50 each of all 24 striped ties and 50 solid red ties).	10.5" x 38" (267mm x 965mm)	10.5" x 6" (267mm x 152mm)	1
PPC25X50	Empty pouch.	10.5" x 38" (267mm x 965mm)	10.5" x 6" (267mm x 152mm)	1
PP5X50F	Pocket pouch filled with 250 cable ties (50 of each color: blue, orange, green, brown, and slate – all with white stripe).	—	3.5" x 5.25" (89mm x 133mm)	1

Cable Tie Tools – Tool Controlled Tension and Cut-Off



- A full line of ergonomic cable tie installation tools that lead the industry in reliability and performance
- Tool controlled tension provides flush cut-off and speeds installation to lower installed cost
- Lightweight and balanced
- Easy to change tension adjustment and easy to operate
- A combination of design, operation, and construction features, provides a long service life
- Replacement blades available
- No special maintenance required



GTS



GTH

Part Number	Used With Cable Ties	Weight		Part Features	Standards	Std. Pkg. Qty.
		oz.	g			
GTS	SM, M, I, S	9.8	278	Ergonomic design with impact resistant resin housing, narrow nose, and cushion handle.	QPL per Mil. Std. SAE AS81306 and Mil. Spec. SAE AS90387-1	1
GTH	S, HS, LH, H	12.0	340	Ergonomic design with impact resistant resin housing, narrow nose, and cushion handle.	QPL per Mil. Std. SAE AS81306 and Mil. Spec. SAE AS90387-2	1

Cable Tie Cross Sections: SM = Subminiature, M = Miniature, I = Intermediate, S = Standard, HS = Heavy-Standard, LH = Light-Heavy, H = Heavy.

Cable Tie Tools – Installer Controlled Tension and Cut-Off

- Economical series of tools for maintenance or construction applications
- Excellent tools for low volume applications



Part Number	Used With Cable Ties	Color	Weight		Part Features	Std. Pkg. Qty.
			oz.	g		
STS2	M, I, S	Black	2.5	71	Economical tool with short handle span and top loading feature for right or left handed users.	1
STH2	S, HS, LH, H	Red	2.5	71	Economical tool with short handle span and top loading feature for right or left handed users.	1
ST3EH	LH, H, EH	Blue/Black	9.0	256	Durable, all steel construction with comfortable plastic handles.	1

Cable Tie Cross Sections: M = Miniature, I = Intermediate, S = Standard, HS = Heavy-Standard, LH = Light-Heavy, H = Heavy, EH = Extra-Heavy.

Hot Stamping Service Custom Printed Cable Ties

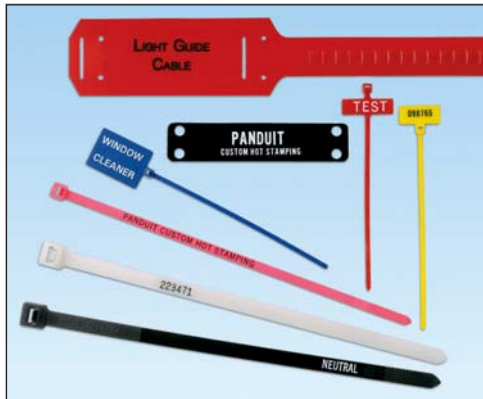

Custom Hot Stamping Service provides a permanent, high quality imprinted message on Panduit cable ties and marker plates. Graphics, text, numbers, and colors provide a variety of choices for customization.

Hot stamped cable ties and marker plates are typically used for identification, or for labeling critical components. Panduit cable ties, marker ties, marker plates, and marker straps are available to suit your application.

Your choice of:

- Seven text colors (black, blue, green, red, yellow, orange, white)
- A variety of characters and fonts
- Sequential numbering
- Special customer logos and diagrams

FAST! TWO WEEK LEAD TIME**

Minimum Order: (Pieces/part number and message)

- 5,000 for Miniature*, Intermediate, Standard and Heavy-Standard cross section cable ties
- 3,000 for Light-Heavy, Heavy, and Extra-Heavy cross section cable ties

For hot stamping orders and inquiries, please call 1-800-777-3300

*Custom Imprinting available on Miniature Cross section for the Flag Style Ties (PLF) only.

**Hot Stamp products made with non-standard parts or colors have a minimum three week lead time.



Cable Ties

- Used wherever you need to bundle wire, cable, hose, or tubing
- A variety of colors for color-coding applications
- Cross Sections: Intermediate, Standard, Heavy-Standard, Light-Heavy, Heavy and Extra-Heavy



Marker and Flag Ties

- Fasten and identify bundles at the same time
- A variety of colors for color-coding applications
- Cross Sections: Miniature and Standard



Marker Plates

- Mount in any direction, either vertically or horizontally as flags, tags, or wrap-around identification plates.
- White or Weather Resistant black color
- Marker plate sizes:

1.50" x .75"	2.50" x .75"
1.75" x .75"	3.50" x .75"
2.00" x .75"	2.50" x 1.75"



Cable Marker Straps

- Identify and code telephone and fiber optic cable – replaces costly and cumbersome lead marking tags
- Lightweight and easy to install
- Can be used as **wrap-around** or **flag** marker
- Also can be used in underground identification applications
- Polyethylene material available in red and gray
- Marking area: 1.50" x 2.62"

Tak-Ty® Hook & Loop Cable Tie Mounts

- For use with TTS Tak-Tape™ and HLT/HLS Tak-Ty® Hook & Loop Cable Ties
- Unique cradle design provides maximum stability for cable bundle
- For indoor use only
- Dimensions: 1.10"L x 1.10"W x .34"H (27.9mm x 27.9mm x 8.6mm)



Part Number	Material	Color	Mounting Method	Std. Pkg. Qty.	Std. Ctn. Qty.
ABMT-A-C*	Nylon 6.6	Natural	Pre-installed Rubber Adhesive	100	1000
ABMT-A-C20*		Black		100	1000
ABMT-S6-C	Nylon 6.6	Natural	#6 (M3) Screw	100	1000
ABMT-S6-C20		Black		100	1000
ABMT-S6-C60**	Flame Retardant Nylon 6.6	Black		100	1000
ABMT-S6-C69**		Natural		100	1000

*Maximum static load for adhesive backed mounts is .38 lbs. (174g).

**Flame retardant products are manufactured from a material that is rated UL 94V-0.

4-Way Adhesive Backed Cable Tie Mounts

- Allow cable tie entry from all four sides
- Available in multiple sizes to match application load requirements
- Produced 2-up and with tear tabs for fast and easy liner removal to speed installation
- Rubber-based adhesive provides a strong and reliable bond
- For indoor use only



Part Number	Used With Cable Ties	Length		Width		Material	Color	Std. Pkg. Qty.	Std. Ctn. Qty.
		In.	mm	In.	mm				
ABM1M-A-C	M	.50	12.7	.50	12.7	Nylon 6.6	White	100	500
ABMM-A-C	M, I	.75	19.1	.75	19.1	ABS	White	100	500
ABMM-A-C20	M, I	.75	19.1	.75	19.1		Black	100	500
ABM2S-A-C	M, I, S	1.00	25.4	1.00	25.4		White	100	500
ABM2S-A-C14	M, I, S	1.00	25.4	1.00	25.4		Gray	100	500
ABM2S-A-C15	M, I, S	1.00	25.4	1.00	25.4		Ivory	100	500
ABM2S-A-C20	M, I, S	1.00	25.4	1.00	25.4		Black	100	500
ABM100-A-C	M, I, S	1.00	25.4	1.00	25.4	Nylon 6.6	White	100	1000
ABM100-A-C15	M, I, S	1.00	25.4	1.00	25.4		Ivory	100	1000
ABM100-A-D20	M, I, S	1.00	25.4	1.00	25.4		Black	500	5000
ABM112-A-C	M, I, S	1.12	28.6	1.12	28.6		White	100	500
ABM112-A-D20	M, I, S	1.12	28.6	1.12	28.6		Black	500	5000
ABM3H-A-L	M, I, S, HS, LH, H, HLM	1.50	38.1	1.50	38.1		White	50	500
ABM3H-A-L20		1.50	38.1	1.50	38.1		Black	50	500
ABM4H-A-L		2.00	50.8	2.00	50.8		White	50	500

Cable Tie Cross Sections: M = Miniature, I = Intermediate, S = Standard, HS = Heavy-Standard, LH = Light-Heavy, H = Heavy, HLM = Miniature Tak-Ty® Hook & Loop Cable Ties.

® Cable Tie Mounts



- Unique cradle design provides maximum stability for the cable bundle
- Low profile design keeps bundle close to mounting surface
- Material: Nylon 6.6 or as specified below

Part Number	Used With Cable Ties	Length		Width		Height		Color	Mounting Method	Std. Pkg. Qty.	Std. Ctn. Qty.
		In.	mm	In.	mm	In.	mm				
TM1S4-C	M	.51	13.0	.32	8.0	.23	5.8	Natural	#4 (M2.5) screw	100	500
TM1S4-C0*	M							Black			
TM1S6-C	M							Natural	100	500	
TM1S6-C0*	M							Black			
TM2S6-C	M, I, S	.63	16.0	.43	10.8	.28	7.0	Natural	#6 (M3) screw	100	500
TM2S6-C0*	M, I, S							Black			
TM2S8-C	M, I, S							Natural	100	500	
TM2S8-C0*	M, I, S							Black			
TM3S8-C	M, I, S, LH	.86	21.9	.61	15.5	.37	9.4	Natural	#8 (M4) screw	100	500
TM3S8-C0*	M, I, S, LH							Black			
TM3S10-C	M, I, S, LH							Natural	100	500	
TM3S10-C0*	M, I, S, LH							Black			
TM3S2510-C30**	M, I, S, LH	.87	22.2	.62	15.7	.38	9.6	Black	#10 (M5) screw	100	500
TM3S2510-C39**	M, I, S, LH	.87	22.2	.62	15.7	.38	9.6	Natural		100	500
TM3S25-C	M, I, S, LH	.88	22.3	.63	16.0	.38	9.6	Natural	1/4 (M6) screw	100	500
TM3S25-C0*	M, I, S, LH	.88	22.3	.63	16.0	.38	9.6	Black			

*Material: Weather Resistant Nylon 6.6
 **Material: Heat Stabilized Nylon 6.6
 Cable Tie Cross Sections: M = Miniature, I = Intermediate, S = Standard, LH = Light-Heavy.

® Extra-Heavy Cable Tie Mounts

- Unique cradle design provides maximum stability for cable bundle
- Dimensions are 1.62"L x 0.72"W x .61"H (41.4mm x 18.8mm x 15.5mm)*
- Route and support large diameter and heavy cable bundles
- Weather resistant material for indoor/outdoor use



Part Number	Used With Cable Ties	Material	Mounting Method	Std. Pkg. Qty.	Std. Ctn. Qty.
TMEH-S8-Q0	I, S, H, EH	Weather Resistant Nylon 6.6	#8 (M4) Screw	25	250
TMEH-S10-Q0			#10 (M5) Screw	25	250
TMEH-S10-C100		Weather Resistant Polypropylene	#10 (M5) Screw	100	500
TMEH-S10-C109		Polypropylene	#10 (M5) Screw	100	500
TMEH-S25-Q0		Weather Resistant Nylon 6.6	1/4" (M6) Screw	25	250

All product color is black.
 *Polypropylene parts (TMEH-S10-C100, TMEH-S10-C109) have an overall length of 1.65" (41.9mm).
 Cable Tie Cross Sections: I = Intermediate, S = Standard, H = Heavy, EH = Extra Heavy.

Push Mounts with Umbrella

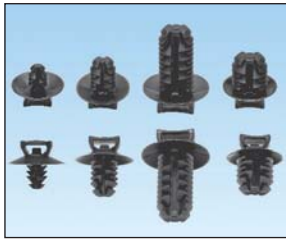

- Unique alternating barb design
- Lock securely into position
- Umbrella tensioning
- Exclusive contoured anvil head
- Material: Heat Stabilized Nylon 6.6

Part Number	Used With Cable Ties	Head Diameter		Panel to Top of Mount		Overall Height		Panel Hole Diameter Range		Panel Thickness Range		Std. Pkg. Qty.	Std. Ctn. Qty.
		In.	mm	In.	mm	In.	mm	In.	mm	In.	mm		
PUM-049-M30	M, I, S	.67	17.0	.26	6.6	.54	13.8	.18 – .19	4.6 – 4.9	.03 – .19	0.7 – 3.0	1000	5000
PUM-071-M30	M, I, S	.67	17.0	.26	6.6	.67	16.9	.25 – .28	6.3 – 7.1	.03 – .28	0.8 – 7.0	1000	5000
PUM-100-M30	M, I, S	.64	16.0	.26	6.6	.67	16.9	.35 – .40	9.0 – 10.0	.03 – .28	0.8 – 7.0	1000	5000
PUM-925-M30	M, I, S, LH	.77	20.0	.30	7.6	1.05	26.7	.34 – .36	8.8 – 9.3	.04 – .62	1.0 – 16.0	1000	5000

Cable Tie Cross Section: M = Miniature, I = Intermediate, S = Standard, LH = Light-Heavy.

Adhesive Backed Cord Clips

- Cables are easily snapped into or out of the clips
- Rubber-based adhesive provides a strong and reliable bond
- For indoor use only
- Material: Nylon 6.6; Parts with suffix (M300) are Heat Stabilized Nylon 6.6



Part Number	Max. Bundle Diameter		Length		Width		Height		Color	Std. Pkg. Qty.	Std. Ctn. Qty.
	In.	mm	In.	mm	In.	mm	In.	mm			
ACC19-A-C	0.19	4.8	0.75	19.0	0.62	15.7	0.25	6.4	Natural	100	500
ACC19-A-C20	0.19	4.8	0.75	19.0	0.62	15.7	0.25	6.4	Black	100	500
ACC38-A-C	0.38	9.7	1.00	25.4	1.00	25.4	0.38	9.7	Natural	100	500
ACC38-A-C20	0.38	9.7	1.00	25.4	1.00	25.4	0.38	9.7	Black	100	500
ACC62-A-C	0.62	15.7	1.24	31.5	1.12	28.4	0.63	16.0	Natural	100	500
ACC62-A-C20	0.62	15.7	1.24	31.5	1.12	28.4	0.63	16.0	Black	100	500
ACC19-AV-M300	0.19	4.8	0.75	19.0	0.62	15.7	0.38	6.4	Black	1000	5000
ACC38-AV-M300	0.38	9.7	1.00	25.4	1.00	25.4	0.40	10.2	Black	1000	5000
ACC62-AV-M300	0.62	15.7	1.24	31.5	1.12	28.4	0.63	16.0	Black	500	5000

Clincher™ Adjustable Releasable Clamp

- Adjustable clamp designed to contain a range of cable bundle diameters
- Latch can be released to provide access to cable bundles
- Bundle range: .19" – .68" (4.8mm – 17.3mm) diameter
- Dimensions are 1.00"L x 1.00"W (25.4mm x 25.4mm)
- For indoor use only
- Material: Polypropylene



Part Number	Mounting Method	Color	Std. Pkg. Qty.	Std. Ctn. Qty.
ARC.68-A-Q14	Rubber Adhesive	Gray	25	250
ARC.68-S6-Q14	#6 (M3) Screw	Gray	25	250
ARC.68-A-Q	Rubber Adhesive	White	25	250
ARC.68-S6-Q	#6 (M3) Screw	White	25	250

Bevel Entry Clips

- Beveled entry allows for easy insertion of cable bundle
- Rubber-based adhesive provides a strong and reliable bond

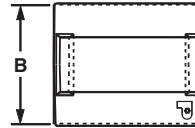
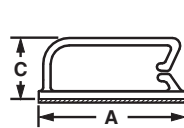
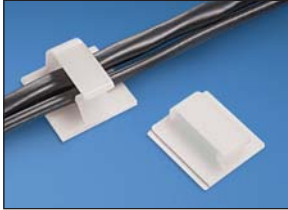

BEC

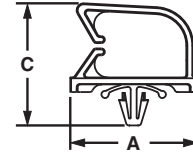

BECP

Part Number	Max. Bundle Diameter		Length A		Width B		Height C		Material	Color	Mounting Method	Std. Pkg. Qty.	Std. Ctn. Qty.
	In.	mm	In.	mm	In.	mm	In.	mm					
Adhesive Backed													
BEC38-A-L	0.38	9.6	1.46	37.1	1.24	31.5	0.52	13.2	Nylon 6.6	Natural	Rubber Adhesive	50	500
BEC38-A-L20									Nylon 6.6	Black		50	500
BEC38-AT-L0									Weather Resistant Nylon 6.6	Black	Acrylic Adhesive Tape	50	500
BEC62-A-L	0.62	15.7	1.46	37.1	1.24	31.5	0.79	20.1	Nylon 6.6	Natural	Rubber Adhesive	50	500
BEC62-A-L20									Nylon 6.6	Black		50	500
BEC62-AT-L0									Weather Resistant Nylon 6.6	Black	Acrylic Adhesive Tape	50	500
BEC75-A-L	0.75	19.0	1.49	37.8	1.49	37.8	0.89	22.6	Nylon 6.6	Natural	Rubber Adhesive	50	500
BEC75-A-L20									Nylon 6.6	Black		50	500
BEC75-AT-L0									Weather Resistant Nylon 6.6	Black	Acrylic Adhesive Tape	50	500

Push Barb

BECP38H25-L	0.38	9.6	1.46	37.1	0.73	18.5	1.00	25.4	Nylon 6.6	Natural	Push Barb	50	500
BECP38H25-L20	0.38	9.6	1.46	37.1						Black		50	500
BECP75H25-L	0.75	19.0	1.47	37.3	Natural	50	500						
BECP75H25-L20	0.75	19.0	1.47	37.3	Black	50	500						

Wire Bundle Strap

- Securely routes large cable bundles
- Rounded edges prevent damage to cable jackets
- Mounting method: two 1/4" (M6) screws
- Dimensions are 4.70"L x 1.00"W x 2.54"H (119.4mm x 25.4mm x 64.5mm)
- For indoor use only



Part Number	Material	Color	Std. Pkg. Qty.	Std. Ctn. Qty.
WBS6-Q	ABS	White	25	125
WBS6-Q60*	Flame Retardant Nylon 6.6	Black	25	125

*Manufactured from a UL 94V-0 material.

Latching Wire Clips

- Route and secure cords and cables
- Convenient releasable latch
- Available in six sizes with releasable latch
- Push barb parts are for use with a max panel thickness of .11" (2.7mm) and a hole diameter of .22" (5.6mm)
- For indoor use only
- Material: Nylon 6.6

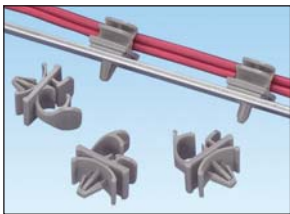
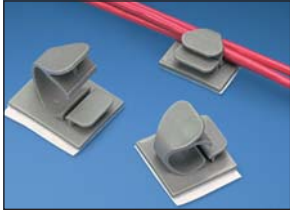

Part Number	Max. Bundle Diameter		Length		Width		Color	Std. Pkg. Qty.	Std. Ctn. Qty.
	In.	mm	In.	mm	In.	mm			
Adhesive Backed									
LWC19-A-C	.19	4.8	.85	21.6	.61	15.5	Natural	100	1000
LWC19-A-C14							Gray	100	1000
LWC19-A-C20							Black	100	1000
LWC25-A-C	.25	6.4	.88	22.4	1.00	25.4	Natural	100	1000
LWC25-A-C14							Gray	100	1000
LWC25-A-C20							Black	100	1000
LWC38-A-C	.38	9.5	1.00	25.4	1.00	25.4	Natural	100	1000
LWC38-A-C14							Gray	100	1000
LWC38-A-C20							Black	100	1000
LWC50-A-L	.50	12.7	1.26	32.0	1.00	25.4	Natural	50	500
LWC50-A-L14							Gray	50	500
LWC50-A-L20							Black	50	500
LWC75-A-L	.75	19.1	1.48	37.6	1.24	31.5	Natural	50	500
LWC75-A-L14							Gray	50	500
LWC75-A-L20							Black	50	500
LWC100-A-L	1.00	25.4	2.21	56.1	1.97	50.0	Natural	50	500
LWC100-A-L14							Gray	50	500
LWC100-A-L20							Black	50	500
Push Mount									
LWC19-H25-C	.19	4.8	.85	21.6	.51	12.8	Natural	100	1000
LWC19-H25-C14	.19	4.8	.85	21.6	.51	12.8	Gray	100	1000
LWC25-H25-C	.25	6.4	.86	21.8	.58	14.7	Natural	100	1000
LWC25-H25-C14							Gray	100	1000
LWC25-H25-C20							Black	100	1000
LWC38-H25-C	.38	9.5	.94	23.9	.58	14.7	Natural	100	1000
LWC38-H25-C14	.38	9.5	.94	23.9	.58	14.7	Gray	100	1000
LWC50-H25-L	.50	12.7	1.25	31.8	.76	19.3	Natural	50	500
LWC50-H25-L14							Gray	50	500
LWC50-H25-L20							Black	50	500
LWC75-H25-L	.75	19.1	1.45	36.8	.87	22.1	Natural	50	500
LWC75-H25-L14							Gray	50	500
LWC75-H25-L20							Black	50	500
LWC100-H25-L	1.00	25.4	1.89	47.9	.99	25.2	Natural	50	500
LWC100-H25-L14							Gray	50	500
LWC100-H25-L20							Black	50	500

P Fixed Diameter Cable Clamps

• Durable Nylon 6.6 cable clamps

• Fully radiused edges



Part Number	Max. Bundle Dia.		Width		Bundle Offset		Mounting Method	Std. Pkg. Qty.	Std. Ctn. Qty.
	In.	mm	In.	mm	In.	mm			
CCS12-S8-C	.12	3.1	.37	9.4	.33	8.4	#8 (M4) Screw	100	500
CCS19-S8-C	.19	4.8	.37	9.4	.43	10.9	#8 (M4) Screw	100	500
CCS25-S8-C	.25	6.3	.37	9.4	.41	10.4	#8 (M4) Screw	100	500
CCS25-S10-C	.25	6.3	.37	9.4	.41	10.4	#10 (M5) Screw	100	500
CCS31-S8-C	.31	7.9	.37	9.4	.49	12.4	#8 (M4) Screw	100	500
CCS38-S8-C	.38	9.5	.37	9.4	.59	15.0	#8 (M4) Screw	100	500
CCS44-S8-C	.44	11.1	.37	9.4	.57	14.5	#8 (M4) Screw	100	500
CCS50-S8-C	.50	12.7	.37	9.4	.60	15.2	#8 (M4) Screw	100	500
CCH12-S10-C	.12	3.1	.50	12.7	.36	9.1	#10 (M5) Screw	100	500
CCH19-S10-C	.19	4.8	.50	12.7	.42	10.7	#10 (M5) Screw	100	500
CCH25-S10-C	.25	6.3	.50	12.7	.46	11.7	#10 (M5) Screw	100	500
CCH31-S10-C	.31	7.9	.50	12.7	.50	12.7	#10 (M5) Screw	100	500
CCH38-S10-C	.38	9.5	.50	12.7	.53	13.5	#10 (M5) Screw	100	500
CCH44-S10-C	.44	11.1	.50	12.7	.56	14.2	#10 (M5) Screw	100	500
CCH50-S10-C	.50	12.7	.50	12.7	.59	15.0	#10 (M5) Screw	100	500
CCH56-S10-C	.56	14.2	.50	12.7	.61	15.5	#10 (M5) Screw	100	500
CCH62-S10-C	.62	15.7	.50	12.7	.65	16.5	#10 (M5) Screw	100	500
CCH69-S10-C	.69	17.5	.50	12.7	.75	19.1	#10 (M5) Screw	100	500
CCH75-S10-C	.75	19.1	.50	12.7	.78	19.8	#10 (M5) Screw	100	500
CCH81-S10-C	.81	20.6	.50	12.7	.81	20.6	#10 (M5) Screw	100	500
CCH87-S10-C	.87	22.1	.50	12.7	.84	21.3	#10 (M5) Screw	100	500
CCH100-S10-C	1.00	25.4	.50	12.7	.91	23.1	#10 (M5) Screw	100	500
CCH112-S10-C	1.12	28.4	.50	12.7	.97	24.6	#10 (M5) Screw	100	500
CCH119-S10-C	1.19	30.2	.50	12.7	1.00	25.4	#10 (M5) Screw	100	500
CCH125-S10-C	1.25	31.8	.50	12.7	1.06	26.9	#10 (M5) Screw	100	500
CCH138-S10-C	1.37	34.8	.50	12.7	1.12	28.4	#10 (M5) Screw	100	500
CCH150-S10-C	1.50	38.1	.50	12.7	1.19	30.2	#10 (M5) Screw	100	500

All parts listed are also available in black weather resistant material (add suffix 0). Bulk package only.

Optical Fiber Network Saddles

- Use in pre-drilled .18 inch (4.0mm) holes in panels up to .09 inch (2.0mm) thick
- Smooth rounded edges eliminate potential for snagging and stress on cable

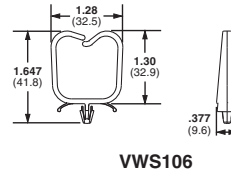
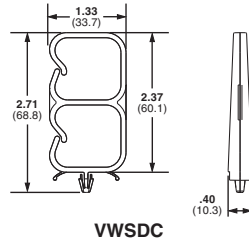

Part Number	Max. Bundle Diameter		Material	Mounting Method	Color	Std. Pkg. Qty.	Std. Ctn. Qty.
	In.	mm					
VWSDC-C*	1.06	26.9	Nylon 6.6	Push Barb	Natural	100	500
VWSDC-C20*	1.06	26.9	Nylon 6.6	Push Barb	Black	100	500
VWS106-C	1.06	26.9	Nylon 6.6	Push Barb	Natural	100	500
VWS106-C20	1.06	26.9	Nylon 6.6	Push Barb	Black	100	500

*Accepts two bundles.

Bridle Rings

- Multiple diameters, thread sizes, and configurations
- Other unique labor saving assemblies differentiate from competition – including pre-assemblies with powder actuated fasteners, toggle wings, and clearance holes for user supplied fasteners
- Not recommended for high performance cables; see J-Pro™ Cable Support System



Wood Screw Thread



Powder Actuated Fastener



User Supplied Nail or Fastener



Integrated Toggle Screw

Part Number	Part Description	Std. Pkg. Qty.
Bridle Rings		
BR-1.25-14WS	Bridle ring, 1.25" dia., 16 wood screw thread.	100
BR-2.0-14WS	Bridle ring, 2.00" dia., 16 wood screw thread.	100
BR-1.5-PAF	Bridle ring, 1.50" dia., with powder actuated fastener.	50
BR-2.0-PAF	Bridle ring, 2.00" dia., with powder actuated fastener.	50
BR-1.5-SN	Bridle ring, 1.50" dia., user supplied nail or fastener.	100
BR-2.0-SN	Bridle ring, 2.00" dia., user supplied nail or fastener.	100
BR-1.5-TW	Bridle ring, 1.50" dia., with integrated toggle screw.	25
BR-2.0-TW	Bridle ring, 2.00" dia., with integrated toggle screw.	25

Physical Properties and Colors of Cable Accessory Materials

	Nylon 6.6	Heat Stabilized Nylon 6.6	Flame Retardant Nylon 6.6	Polypropylene	Nylon 12	TEFZEL [®]	PEEK	Metal Detectable Nylon	Metal Detectable Polypropylene	General Purpose ABS	PVC
Color	Natural	Black	Ivory	Black/Green	Black	Blue	Brown	Blue	Blue	Black/Natural	Gray/White
Part Number Suffix	None	30	69	100/109	120	76	71	86	186	None/20	8/10
Flammability Rating – UL 94	V2	V2	V0	HB	HB	V0	V0	HB	HB	HB	V0
Radiation Resistance (Rads)	1x10 ⁵	1x10 ⁵	1x10 ⁵	1x10 ⁶	3.5x10 ⁶	2x10 ⁸	1x10 ⁹	—	1x10 ⁶	—	—
Water Absorption 24 hours ASTM D570	1.2%	1.2%	1.1%	0.1%	0.3%	<0.03%	0.5%	1.2%	0.1%	0.43%	0.3%
Maximum Continuous Use Temperature UL 746B	185°F 85°C	239°F 115°C	212°F 100°C	239°F 115°C	194°F 90°C	338°F 170°C	500°F 260°C Note 1	185°F 85°C	239°F 115°C	185°F 85°C	122°F 50°C
Minimum Application Use Temperature EN 50146 (Note 2)	-40°F -40°C	-40°F -40°C	-40°F -40°C	-40°F -40°C	-40°F -40°C	-40°F -40°C	-40°F -40°C	-40°F -40°C	-40°F -40°C	-40°F -40°C	-40°F -40°C
Chemical Resistance											
Salts	●	●	●	●	●	●	●	●	●	●	●
Hydrocarbons (Oil, Lubricants)	●	●	●	○	●	●	●	●	○	●	●
Chlorinated Hydrocarbons	●	●	●	○	●	●	●	●	○	●	—
Acids	●	●	●	●	●	●	○	●	●	○	●
Bases	●	●	●	●	●	●	●	●	●	●	—
Acid Rain	●	●	●	●	●	●	●	●	●	●	—

[®]TEFZEL is a registered trademark of E.I. du Pont de Nemours and Company.
 Note 1: Based upon UL RTI for electrical properties.
 Note 2: For more detailed chemical resistance information, see chemical resistance charts available at www.panduit.com

Recommendation Legend	Highest	High	Acceptable	Low	Lowest
	●	●	○	●	●

Application Chart

Since Panduit manufactures adhesive backed mounts with a variety of adhesive types, this chart should be used as a guideline for choosing the best adhesive for often-encountered conditions. Each type of adhesive is rated good, fair or poor for some specific mounting surfaces and/or chemical environments.

Surfaces	Rubber Based Foam Tape Mounts	Acrylic Based Foam Tape Mounts	Epoxy Applied Adhesive Mounts
Plastics	Good	Good	Good
Wood	Good	Good	Good
Glass	Fair	Good	Good
Painted Surfaces	Good	Good	Fair
Powder Coating	Good	Fair	Good
Metal	Good ¹	Good ¹	Good
Paper	Good	Good	Fair
Concrete, Stone, Masonry	Not Recommended	Not Recommended	Good
Chemical Resistance			
Water	Good	Good	Poor
Oil	Poor	Fair ³	Good
Gasoline	Poor	Fair ³	Fair
Dilute Acids	Poor	Fair ³	Fair
Dilute Alkalis	Good	Fair ³	Fair
Organic Solvents	Poor	Fair ³	Not Recommended
Outdoor Exposure	Not Recommended	Good	Good ²

1. Not recommended for use on copper or brass.
 2. Mounts manufactured from outdoor material only. For specific applications, individual testing prior to extensive use is suggested.
 3. Depends on concentration, exposure time, and chemical composition.

ABRASION PROTECTION

Panduit abrasion protection products provide an economical and easy way to insulate, protect, bundle and color-code components and cable. A wide variety of sizes and materials are available to meet a broad range of indoor and outdoor applications. To help assure optimum quality, Panduit abrasion protection products are designed and manufactured to meet applicable quality standards including International, UL, Military, ISO, and Aerospace.



- **Pan-Wrap™ Split Harness Wrap bundles and protects wire and cable**
- **Spiral wrap offering provides the largest variety of colors, materials, and sizes to meet a variety of needs**
- **Braided expandable sleeving provides continuous abrasion resistance and lightweight durable protection, with a flexible open weave that will not trap heat or humidity**
- **Heat shrink end caps are available in different sizes to meet a variety of needs**
- **Corrugated loom tubing is crush, impact, and abrasion resistant to reduce the risk of damage to wire and cable**
- **Grommet edging protects wire and cable from damage caused by sharp panel edges**

Panduit abrasion protection products provide quality at the lowest installed cost. With a continued focus on new product development, Panduit continues to meet customer needs.

Pan-Wrap™ Split Harness Wrap

- Patented slot pattern provides improved flexibility and abrasion protection in any application
- Unique wall design provides for easy cable breakouts
- Innovative design maintains uniform bundle protection in dynamic applications
- Large overlap accommodates a wide range of bundle diameters
- Packaged on a reel for easy handling and dispensing of product
- Considerably reduces installation time



Part Number	Material	Color	Length Per Reel		Max. Bundle Diameter		Min. Bundle Diameter‡		Temperature Range	Nominal I.D.		Std. Pkg. Qty.*
			Ft.	m	In.	mm	In.	mm		In.	mm	
PW38F-TL	Polyethylene	Natural	250	76.2	0.43	10.9	0.25	6.4	-40°F – 122°F (-40°C – 50°C)	0.38	9.5	1
PW38F-TL20	Polyethylene	Black	250	76.2	0.43	10.9	0.25	6.4		0.38	9.5	1
PW38FR-TLY	Flame Retardant Polyethylene	Natural	250	76.2	0.43	10.9	0.25	6.4		0.38	9.5	1
PW38FR-TL20Y	Flame Retardant Polyethylene	Black	250	76.2	0.43	10.9	0.25	6.4	-4°F – 167°F (-20°C – 75°C)	0.38	9.5	1
PW50F-T	Polyethylene	Natural	200	61.0	0.55	14.0	0.43	10.9	-40°F – 122°F (-40°C – 50°C)	0.50	12.7	1
PW50F-T20	Polyethylene	Black	200	61.0	0.55	14.0	0.43	10.9		0.50	12.7	1
PW50F-T3	Polyethylene	Orange	200	61.0	0.55	14.0	0.43	10.9		0.50	12.7	1
PW50F-T4	Polyethylene	Yellow	200	61.0	0.55	14.0	0.43	10.9		0.50	12.7	1
PW50FR-TY	Flame Retardant Polyethylene	Natural	200	61.0	0.55	14.0	0.43	10.9	-4°F – 167°F (-20°C – 75°C)	0.50	12.7	1
PW50FR-T20Y	Flame Retardant Polyethylene	Black	200	61.0	0.55	14.0	0.43	10.9		0.50	12.7	1
PW75F-C	Polyethylene	Natural	100	30.5	0.81	20.6	0.55	14.0	-40°F – 122°F (-40°C – 50°C)	0.75	19.1	1
PW75F-C20	Polyethylene	Black	100	30.5	0.81	20.6	0.55	14.0		0.75	19.1	1
PW75F-C3	Polyethylene	Orange	100	30.5	0.81	20.6	0.55	14.0		0.75	19.1	1
PW75F-C4	Polyethylene	Yellow	100	30.5	0.81	20.6	0.55	14.0		0.75	19.1	1
PW75FR-CY	Flame Retardant Polyethylene	Natural	100	30.5	0.81	20.6	0.55	14.0	-4°F – 167°F (-20°C – 75°C)	0.75	19.1	1
PW75FR-C20Y	Flame Retardant Polyethylene	Black	100	30.5	0.81	20.6	0.55	14.0		0.75	19.1	1
PW100F-C	Polyethylene	Natural	100	30.5	1.13	28.6	0.81	20.6	-40°F – 122°F (-40°C – 50°C)	1.00	25.4	1
PW100F-C20	Polyethylene	Black	100	30.5	1.13	28.6	0.81	20.6		1.00	25.4	1
PW100F-C3	Polyethylene	Orange	100	30.5	1.13	28.6	0.81	20.6		1.00	25.4	1
PW100F-C4	Polyethylene	Yellow	100	30.5	1.13	28.6	0.81	20.6		1.00	25.4	1
PW100FR-CY	Flame Retardant Polyethylene	Natural	100	30.5	1.13	28.6	0.81	20.6		1.00	25.4	1
PW100FR-C20Y	Flame Retardant Polyethylene	Black	100	30.5	1.13	28.6	0.81	20.6	-4°F – 167°F (-20°C – 75°C)	1.00	25.4	1
PW150F-L	Polyethylene	Natural	50	15.2	1.63	41.3	1.13	28.6	-40°F – 122°F (-40°C – 50°C)	1.50	38.1	1
PW150F-L20	Polyethylene	Black	50	15.2	1.63	41.3	1.13	28.6		1.50	38.1	1
PW150F-L3	Polyethylene	Orange	50	15.2	1.63	41.3	1.13	28.6		1.50	38.1	1
PW150F-L4	Polyethylene	Yellow	50	15.2	1.63	41.3	1.13	28.6		1.50	38.1	1
PW150FR-LY	Flame Retardant Polyethylene	Natural	50	15.2	1.63	41.3	1.13	28.6		1.50	38.1	1
PW150FR-L20Y	Flame Retardant Polyethylene	Black	50	15.2	1.63	41.3	1.13	28.6	-4°F – 167°F (-20°C – 75°C)	1.50	38.1	1

*Order number of reels required.

‡Diameter can be further reduced with the use of cable ties.

Pan-Wrap™ Installation Tools

- Patented installation tool with 180° opening allows easy loading of maximum bundle diameters to speed installation, providing the lowest installed cost



Part Number	Color	For Use With	Std. Pkg. Qty.*
PWT38	White	PW38F- Series	1
PWT50	White	PW50F- Series	1
PWT75	White	PW75F- Series	1
PWT100	White	PW100F- Series	1
PWT150	White	PW150F- Series	1

*Order number of tools required.

SW Spiral Wrap

- Harness multiple cables into a single manageable bundle
- Allows breakouts of single/multiple cables
- Provides protection for cables
- Multiple colors allow easy identification of cable bundles
- Reusable
- General purpose material for use up to 122°F (50°C);
Flame retardant material for use up to 167°F (75°C)
- Installation tool supplied in each package
- Outside diameter: 0.50" (12.7mm)
- Wall Thickness: 0.06" (1.52mm)
- Bundle range: 0.38" – 4.00" (9.5mm – 101.6mm)
- Packaged on a 100' (30.5M) reel for easy handling and dispensing of product

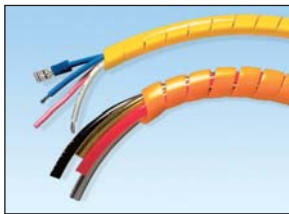

Part Number	Material	Color	Length of Reel‡		Std. Pkg. Qty.*
			Ft.	m	
T50F-C	Polyethylene	Natural	100	30.5	1
T50F-C0	Weather Resistant Polyethylene	Black	100	30.5	1
T50F-C1	Polyethylene	Brown	100	30.5	1
T50F-C2	Polyethylene	Red	100	30.5	1
T50F-C3Y	Polyethylene	Orange	100	30.5	1
T50F-C4Y	Polyethylene	Yellow	100	30.5	1
T50F-C5	Polyethylene	Green	100	30.5	1
T50F-C6	Polyethylene	Blue	100	30.5	1
T50F-C7	Polyethylene	Purple	100	30.5	1
T50F-C8	Polyethylene	Gray	100	30.5	1
T50F-C10	Polyethylene	White	100	30.5	1
T50F-C16	Polyethylene	Pink	100	30.5	1
T50FR-CY**	Flame Retardant Polyethylene	White	100	30.5	1
T50FR-C20Y**	Flame Retardant Polyethylene	Black	100	30.5	1

‡Reel packaging may contain splices.

*Order number of reels required.

**Flame retardant products are manufactured from a material that is rated UL 94V-0 and RoHS compliant. Contact Panduit Customer Service for additional sizes and materials available.

® Braided Expandable Sleeving – Polyethylene Terephthalate (PET)

- Provides continuous abrasion protection for wires, cables, hoses, and tubing
- Highly flexible open weave will not trap heat or humidity
- Allows for use with irregular shapes
- Lightweight, durable protection
- Rated for use up to 257°F (125°C)
- Compliant with U.S. and European passenger rail standards



Part Number	Color	Nominal I.D.		Nominal Diameter Range		Length per reel		Std. Pkg. Qty.	Std. Ctn. Qty.
		In.	mm	In.	mm	Ft.	m		
SE12P-TR0	Black	0.12	3.2	0.094 – 0.250	2.4 – 6.4	200	61.0	1	4
SE25P-TR0	Black	0.25	6.4	0.125 – 0.375	3.2 – 9.5	200	61.0	1	4
SE38P-TR0	Black	0.38	9.5	0.188 – 0.500	4.8 – 15.9	200	61.0	1	4
SE50P-CR0	Black	0.50	12.7	0.250 – 0.750	6.4 – 19.1	100	30.5	1	4
SE75P-CR0	Black	0.75	19.1	0.500 – 1.25	12.7 – 31.8	100	30.5	1	4
SE125P-LR0	Black	1.25	31.8	0.750 – 1.50	19.1 – 38.1	50	15.2	1	4
SE150P-LR0	Black	1.50	38.1	1.00 – 2.13	25.4 – 54.0	50	15.2	1	4
SE175P-TR0	Black	1.75	44.5	1.25 – 2.75	31.8 – 69.9	200	61.0	1	2

Reel packaging may contain splices. Contact Panduit Customer Service for further information.

® Fray Resistant Braided Expandable Sleeving

- Fray-resistant design resists fraying when cut with scissors
- Provides continuous abrasion protection resistance for wires, cables, and tubing
- For indoor use only
- Material: Polyethylene Terephthalate
- Rated for use up to 257°F (125°C)



Part Number	Color	Nominal I.D.		Nominal Diameter Range		Length Per Reel†		Std. Pkg. Qty.	Std. Ctn. Qty.
		In.	mm	In.	mm	Ft.	m		
SE12PSC-TR0	Black	0.12	3.2	0.13 – 0.25	3.2 – 6.4	200	61.0	1	4
SE25PSC-TR0	Black	0.25	6.4	0.16 – 0.44	4.0 – 11.1	200	61.0	1	4
SE38PSC-TR0	Black	0.38	9.5	0.19 – 0.63	4.8 – 15.9	200	61.0	1	4
SE50PSC-CR0	Black	0.50	12.7	0.25 – 0.75	6.4 – 19.1	100	30.5	1	4
SE75PSC-CR0	Black	0.75	19.1	0.63 – 1.0	15.9 – 25.4	100	30.5	1	4
SE125PSC-LR0	Black	1.25	31.8	1.0 – 1.5	25.4 – 38.1	50	15.2	1	4
SE150PSC-LR0	Black	1.50	38.1	1.3 – 2.0	31.8 – 50.8	50	15.2	1	4

†Reel packaging may contain splices. Contact Panduit Customer Service for further information.

® Heat Shrink Flame Retardant End Caps

- Applications include insulating and protecting wires and cables
- Adhesive lined inner wall seals and provides excellent protection against moisture
- Voltage rating of 600 V
- Shrink ratio: 3:1
- Temperature range: -67°F to 230°F (-55°C to 110°C)
- Material: Adhesive lined black flame retardant cross-linked Polyolefin



Part Number	Min. Expanded I.D.		Max. Recovered I.D.		Nominal Recovered Wall Thickness		Cap Length		Std. Pkg. Qty.	Std. Ctn. Qty.
	In.	mm	In.	mm	In.	mm	In.	mm		
HSECFR0.5-XY	0.51	13.0	0.16	4.1	0.09	2.3	2.5	63.5	10	100
HSECFR0.8-XY	0.75	19.1	0.24	6.1	0.09	2.3	2.5	63.5	10	100
HSECFR1.0-XY	1.10	27.9	0.35	8.9	0.12	3.0	3.0	76.2	10	100
HSECFR1.5-5Y	1.50	38.1	0.47	11.9	0.16	4.1	3.5	88.9	5	50
HSECFR2.0-5Y	2.00	50.8	0.63	16.0	0.16	4.1	3.5	88.9	5	50

Corrugated Loom Tubing

- Provides protection for cables
- For indoor use only

- Material: Polyethylene
- Temperature Range: -40°F to 122°F (-40°C to 50°C)



Part Number	Color	Inside Diameter		Outside Diameter		Length of Reel‡		Std. Pkg. Qty.*
		In.	mm	In.	mm	Ft.	m	
Slit Wall								
CLT25F-C3**	Orange	0.28	7.0	0.40	10.1	100	30.5	1
CLT38F-C3	Orange	0.42	10.5	0.56	14.1	100	30.5	1
CLT50F-C3	Orange	0.51	12.8	0.67	17.0	100	30.5	1
CLT75F-C3	Orange	0.76	19.3	0.94	23.8	100	30.5	1
CLT100F-C3	Orange	0.92	23.2	1.09	27.7	100	30.5	1
CLT125F-L3	Orange	1.29	32.8	1.50	38.1	50	15.2	1
CLT150F-X3	Orange	1.48	37.6	1.73	43.9	10	3.1	1
CLT188F-X3	Orange	1.88	47.8	2.17	55.1	10	3.1	1
CLT25F-C20**	Black	0.28	7.0	0.40	10.1	100	30.5	1
CLT38F-C20	Black	0.42	10.5	0.56	14.1	100	30.5	1
CLT50F-C20	Black	0.51	12.8	0.67	17.0	100	30.5	1
CLT75F-C20	Black	0.76	19.3	0.94	23.8	100	30.5	1
CLT100F-C20	Black	0.92	23.2	1.09	27.7	100	30.5	1
CLT125F-L20	Black	1.29	32.8	1.50	38.1	50	15.2	1
CLT150F-T20	Black	1.48	37.6	1.73	43.9	200	61.0	1
CLT150F-X20	Black	1.48	37.6	1.73	43.9	10	3.0	1
CLT188F-X20	Black	1.88	47.8	2.17	55.1	10	3.1	1
CLT150F-X4	Yellow	1.48	37.6	1.73	43.9	10	3.1	1
CLT188F-X4	Yellow	1.88	47.8	2.17	55.1	10	3.1	1

Solid Wall

CLTS25F-C3**	Orange	0.28	7.0	0.40	10.1	100	30.5	1
CLTS38F-C3	Orange	0.42	10.5	0.56	14.1	100	30.5	1
CLTS50F-C3	Orange	0.51	12.8	0.67	17.0	100	30.5	1
CLTS75F-C3	Orange	0.76	19.3	0.94	23.8	100	30.5	1
CLTS100F-C3	Orange	0.92	23.2	1.09	27.7	100	30.5	1
CLTS125F-L3	Orange	1.29	32.8	1.50	38.1	50	15.2	1
CLTS150F-D3	Orange	1.48	37.6	1.73	43.9	500	152.4	1
CLTS25F-C**	Black	0.28	7.0	0.40	10.1	100	30.5	1
CLTS38F-C	Black	0.42	10.5	0.56	14.1	100	30.5	1
CLTS50F-C	Black	0.51	12.8	0.67	17.0	100	30.5	1
CLTS75F-C	Black	0.76	19.3	0.94	23.8	100	30.5	1
CLTS100F-C	Black	0.92	23.2	1.09	27.7	100	30.5	1
CLTS125F-L	Black	1.29	32.8	1.50	38.1	50	15.2	1

‡Reel packaging may contain splices.

* Order number of reels required.

Contact Panduit Customer Service for additional sizes, materials, colors and bulk packaging.

**Designated parts packaged in dispenser carton, not on reel.

Grommet Edging

- Adhesive lining ensures product stays in place
- Slotted wall product used on irregularly shaped and round panel holes
- Solid wall product used on straight panels
- Highly flexible material
- General purpose material for use up to 122°F (50°C)
- Flame retardant material for use up to 167°F (75°C)
- Packaged on a 100' (30.5m) reel for easy handling and dispensing of product

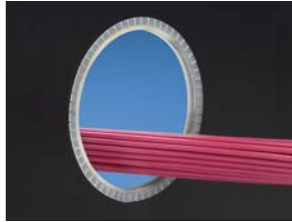

Part Number	Width		Height		Material	Color	Panel Thickness Range		Std. Pkg. Qty.
	In.	mm	In.	mm			In.	mm	
Slotted Adhesive Lined									
GEE62F-A-C	0.13	3.3	0.16	4.1	Polyethylene	Natural	0.036 – 0.062	0.9 – 1.6	1
GEE62F-A-C0	0.13	3.3	0.16	4.1	Weather Resistant Polyethylene	Black	0.036 – 0.062	0.9 – 1.6	1
GEE99F-A-C	0.17	4.3	0.19	4.7	Polyethylene	Natural	0.062 – 0.099	1.6 – 2.5	1
GEE99F-A-C0	0.17	4.3	0.19	4.7	Weather Resistant Polyethylene	Black	0.062 – 0.099	1.6 – 2.5	1
GEE144F-A-C	0.21	5.4	0.22	5.6	Polyethylene	Natural	0.099 – 0.144	2.5 – 3.7	1
GEE144F-A-C0	0.21	5.4	0.22	5.6	Weather Resistant Polyethylene	Black	0.099 – 0.144	2.5 – 3.7	1

Solid Adhesive Lined – Use on straight edges only

GES62F-A-C	0.13	3.3	0.16	4.1	Polyethylene	Natural	0.036 – 0.062	0.9 – 1.6	1
GES62F-A-C0	0.13	3.3	0.16	4.1	Weather Resistant Polyethylene	Black	0.036 – 0.062	0.9 – 1.6	1
GES99F-A-C	0.17	4.3	0.19	4.7	Polyethylene	Natural	0.062 – 0.099	1.6 – 2.5	1
GES99F-A-C0	0.17	4.3	0.19	4.7	Weather Resistant Polyethylene	Black	0.062 – 0.099	1.6 – 2.5	1
GES144F-A-C	0.21	5.4	0.22	5.6	Polyethylene	Natural	0.099 – 0.144	2.5 – 3.7	1
GES144F-A-C0	0.21	5.4	0.22	5.6	Weather Resistant Polyethylene	Black	0.099 – 0.144	2.5 – 3.7	1

Slotted (without adhesive)

GEE36FR-CY*	0.11	2.7	0.12	3.0	Flame Retardant Polyethylene	Natural	0.026 – 0.036	0.7 – 0.9	1
GEE62FR-CY*	0.13	3.3	0.16	4.1	Flame Retardant Polyethylene	Natural	0.036 – 0.062	0.9 – 1.6	1
GEE99FR-CY*	0.17	4.3	0.19	4.7	Flame Retardant Polyethylene	Natural	0.062 – 0.099	1.6 – 2.5	1
GEE144FR-CY*	0.21	5.4	0.22	5.6	Flame Retardant Polyethylene	Natural	0.099 – 0.144	2.5 – 3.7	1

Solid (without adhesive) – Use on straight edges only

GES36FR-CY*	0.11	2.7	0.12	3.0	Flame Retardant Polyethylene	Natural	0.026 – 0.036	0.7 – 0.9	1
GES62FR-CY*	0.13	3.3	0.16	4.1	Flame Retardant Polyethylene	Natural	0.036 – 0.062	0.9 – 1.6	1
GES99FR-CY*	0.17	4.3	0.19	4.7	Flame Retardant Polyethylene	Natural	0.062 – 0.099	1.6 – 2.5	1
GES144FR-CY*	0.21	5.4	0.22	5.6	Flame Retardant Polyethylene	Natural	0.099 – 0.144	2.5 – 3.7	1

*Flame retardant products are manufactured from a material that is rated UL 94V-0 and RoHS compliant.

‡Reel packaging may contain splices. Order the number of reels required.

Index by Name

System Overview

Table of Contents	A.1
Solutions Roadmap	A.2 – A.3
Unified Physical Infrastructure SM Approach	A.4
Solutions that Enable Technology	A.5
Physical Infrastructure Management	A.5
Power Over Ethernet (PoE)	A.6
10 Gigabit Ethernet Over Copper	A.7
10 Gigabit Ethernet and Fibre Channel Over Fiber	A.8
Fiber Optic Storage Networking Solutions	A.9
Pre-Terminated Copper and Fiber Solutions	A.10
Faster Implementation with Pre-Configured Physical Infrastructures	A.11
Network Grounding and Bonding	A.12
Physical Security	A.13
Connected Building Solutions	A.14
Multi-Dwelling/Multi-Tenant Unit Media Services	A.15
Wireless Solutions	A.16
Ultimate ID [®] Network Labeling	A.17
Workstation Area Roadmap	A.18
Telecommunications Room Roadmap	A.19
Data Center Roadmap	A.20 – A.21
TX Copper Systems Selection Guide	A.22
Fiber Optic Systems Selection Guide	A.23
Global Services and Support	A.24
Environmental Policy	A.24
Restriction of Hazardous Substances (RoHS)	A.24
Panduit Business Partner Program	A.25
Panduit Design Tools	A.26
Panduit Professional Services	A.26

Copper Systems

Copper Systems	B.1
Copper Systems Roadmap	B.2 – B.3
SFP+ 10 Gb/s Direct Attach Passive Cable Assemblies	B.4
SFP+ 10 Gb/s Direct Attach Active Cable Assemblies	B.5
QSFP+ 40Gig Direct Attach Copper Cable Assemblies	B.6
★ QSFP+ to Four SFP+ Copper Hydra Cable Assemblies	B.7
QuickNet™ Cable Assemblies	B.8 – B.9
QuickNet™ Plug Pack Cable Assemblies	B.10 – B.11
Component Labels for QuickNet™ Plug Pack Assemblies	B.11
QuickNet™ Patch Panels and Accessories	B.12
QuickNet™ Plug Pack Housings	B.13
QuickNet™ Plug Pack Removal Tool	B.13
QuickNet™ Plug Pack Lock-in Device	B.13
TX6A™ 10Gig™ U/FTP Shielded Copper Cable	B.14
★ TX6A™ 10Gig™ Shielded F/UTP Copper Cable	B.14
TX7000™ Shielded S/FTP Marine Copper Cable	B.15
Labels for Cable	B.15
Mini-Com® TX6A™ 10Gig™ Shielded Jack Modules	B.16 – B.17
Component Labels for Mini-Com® TX6A™ 10Gig™ Shielded Jack Modules	B.17
TX6A™ 10Gig™ Shielded Patch Cords	B.18
Labels for TX6A™ 10Gig™ Shielded Patch Cords	B.18
TX6A™ 10Gig™ and TX6A-SD™ 10Gig™ UTP Copper Cable with MaTriX Technology	B.19
Mini-Com® TX6A™ 10Gig™ UTP Jack Modules	B.20 – B.21
Component Labels for Mini-Com® TX6A™ 10Gig™ UTP Jack Modules	B.21
DP6A™ 10Gig™ UTP Patch Panels	B.22
Component Labels for DP6A™ 10Gig™ UTP Patch Panels	B.22
★ Mini-Com® Category 6A UTP Coupler Module	B.23
Component Labels for Mini-Com® Category 6A UTP Coupler Module	B.23
★ Category 6A Coupler Patch Panel	B.24
Component Labels for Category 6A Patch Panel	B.24
TX6A™ 10Gig™ UTP Patch Cords with MaTriX Technology	B.25
TX6500™ Enhanced Category 6 UTP Copper Cable	B.26
Labels for TX6500™ Enhanced Category 6 UTP Copper Cable	B.26
TX6000™ High Performance Category 6 UTP Copper Cable	B.27
Labels for TX6000™ High Performance Category 6 UTP Copper Cable	B.27
Mini-Com® TX6™ PLUS UTP Jack Modules	B.28
Mini-Com® TX6™ PLUS Corrosive Resistant UTP Jack Module	B.29

★ Represents new product offering.

Index by NameComponent Labels for Mini-Com[®] TX6[™] PLUS UTP Jack Modules B.29Mini-Com[®] Ultimate ID[®] TX6[™] PLUS Modular Patch Panel Kits B.30Mini-Com[®] TX6[™] PLUS Modular Patch Panel Kits B.30DP6[™] PLUS UTP Patch Panels B.31Component Labels for DP6[™] PLUS UTP Patch Panels B.31Mini-Com[®] Category 6 UTP Coupler Module B.32Component Labels for Mini-Com[®] Category 6 UTP Coupler Module B.32

Category 6 Coupler Patch Panel B.33

Component Labels for Category 6 Coupler Patch Panel B.33

TX6[™] PLUS UTP Patch Cords B.34Labels for TX6[™] PLUS UTP Patch Cords B.34TX6[™] PLUS UTP Modular Plug B.35Mini-Com[®] TX6[™] PLUS Shielded Jack Modules B.36 – B.37Component Labels for Mini-Com[®] TX6[™] PLUS Shielded Jack Modules B.37TX6[™] PLUS Shielded Modular Plug B.38TX5500[™] Enhanced Category 5e UTP Copper Cable B.39Labels for TX5500[™] Enhanced Category 5e UTP Cable B.39Mini-Com[®] TX5e[™] UTP Jack Modules B.39 – B.40Component Labels for Mini-Com[®] TX5e[™] UTP Jack Modules B.40Mini-Com[®] TX5e[™] Corrosive Resistant UTP Jack Module B.42Component Labels for Mini-Com[®] TX5e[™] Corrosive Resistant UTP Jack Module B.42DP5e[™] UTP Patch Panels B.43Component Labels for DP5e[™] UTP Patch Panels B.43Mini-Com[®] Category 5e UTP Coupler Module B.44Component Labels for Mini-Com[®] Category 5e UTP Coupler Module B.44

Category 5e Coupler Patch Panel B.45

Component Labels for Category 5e Coupler Patch Panel B.45

TX5e[™] UTP Patch Cords B.46Labels for TX5e[™] UTP Patch Cords B.46Pan-Plug[®] Category 5e UTP Modular Plugs B.47TX5500[™] Category 5e F/UTP Shielded Copper Cable B.47Labels for TX5500[™] Category 5e F/UTP Shielded Copper Cable B.47Mini-Com[®] TX5e[™] Shielded Jack Modules B.48 – B.49Component Labels for Mini-Com[®] TX5e[™] Shielded Jack Modules B.49TX5e[™] Shielded Patch Cords B.50Labels for TX5e[™] Shielded Patch Cords B.50Pan-Plug[®] Category 5e Shielded Modular Plug B.51TX5500[™] Category 5e 25-Pair UTP Copper Cable B.52Labels for TX5500[™] Category 5e 25-Pair Copper Cable B.52Data-Patch[™] 10/100BASE-T Patch Panels B.53Component Labels for Data-Patch[™] 10/100BASE-T Patch Panels B.53Data-Patch[™] Category 5e RJ21 to RJ45 Patch Panel B.54Component Labels for Data-Patch[™] Category 5e RJ21 to RJ45 Patch Panel B.54Data-Patch[™] 10/100/1000BASE-T Cable Assemblies B.55Labels for Data-Patch[™] 10/100/1000BASE-T Cable Assemblies B.55

RJ45 – HD68 and RJ45 – VHD68 SCSI Angled Patch Panel and Kits B.56

Component Labels for RJ45 – HD68 and RJ45 – VHD68 SCSI Angled Patch Panel and Kits B.56

Mini-Com[®] Mini-Jack[™] Category 3 UTP Jack Modules B.57Component Labels for Mini-Com[®] Mini-Jack[™] Category 3 UTP Jack Modules B.57Mini-Com[®] BAS Connector Module B.58Mini-Com[®] Blank Module B.58Mini-Com[®] F-Type Module B.58Mini-Com[®] Self-Terminating F-Type Module B.59Mini-Com[®] 15-Pin High-Density D-Subminiature Module B.59Mini-Com[®] Module Base for D-Subminiature Connectors B.59

D-Subminiature Inserts B.60

Component Labels for D-Subminiature Inserts B.60

RCA 1/3 Inserts B.61

Mini-Com[®] S-Video Punchdown Module B.61Mini-Com[®] S-Video Pass-Through Module B.62Mini-Com[®] RCA 110 Punchdown Modules B.62Mini-Com[®] RCA Pass-Through Modules B.62Mini-Com[®] 3.5mm Stereo Connector and Coupler Modules B.63Mini-Com[®] 5-Way Binding Post Modules B.63Mini-Com[®] BNC Coax Coupler Modules B.64Mini-Com[®] HDMI Coupler B.64Mini-Com[®] USB Coupler B.64

BNC Coupler Patch Panel B.61

Voice Patch Panel B.61

★ Represents new product offering.

Index by Name

Component Labels for Voice Patch Panel	B.61
Mini-Com® Ultimate ID® Modular Patch Panels	B.66
Mini-Com® Ultimate ID® Patch Panel Faceplates	B.66
Mini-Com® Flush Mount Modular Patch Panels	B.67
Component Labels for Mini-Com® Flush Mount Modular Patch Panels	B.67
Mini-Com® High Density Modular Patch Panels	B.68
Component Labels for Mini-Com® High Density Modular Patch Panels	B.68
Mini-Com® Modular Faceplate Patch Panels	B.69
Component Labels for Mini-Com® Modular Faceplate Patch Panels	B.69
Mini-Com® M6 Style Modular Faceplate Patch Panels	B.70
Component Labels for Mini-Com® M6 Style Modular Faceplate Patch Panels	B.70
Mini-Com® Recessed Modular Faceplate Patch Panels	B.71
Component Labels for Mini-Com® Recessed Modular Faceplate Patch Panels	B.71
Mini-Com® 12-Port Modular Faceplate Patch Panels	B.72
Component Labels for Mini-Com® 12-Port Modular Faceplate Patch Panels	B.72
Mini-Com® All Metal Shielded Modular Patch Panels	B.73
Component Labels for Mini-Com® All Metal Shielded Modular Patch Panels	B.73
Strain Relief Bar with Clips	B.74
Strain Relief Bars for Patch Panels	B.74
Cross Connect Punchdown System	B.75
GP6™ PLUS Category 6 High Density Kits	B.76
GP6™ PLUS Category 6 Standard Density Kits	B.76
GP6™ PLUS Category 6 High Density Rack Mount Panel Kits	B.77
GP6™ PLUS Category 6 Standard Density Rack Mount Panel Kits	B.77
GP6™ PLUS Category 6 Connecting Blocks	B.78
GP6™ PLUS Category 6 High Density Bases	B.78
GP6™ PLUS Category 6 Standard Density Bases	B.79
GP6™ PLUS Standard Density Tower Kit	B.79
Component Labels for GP6™ PLUS Category 6 Standard Density Bases and GP6™ PLUS Standard Density Tower Kit	B.80
GP6™ PLUS Patch Connectors	B.80
GP6™ PLUS Patch Cord Assemblies	B.81
Labels for GP6™ PLUS Patch Cord Assemblies	B.81
GP6™ 1 and 2-Pair Patch Cord Assemblies	B.82
Labels for GP6™ 1 and 2-Pair Patch Cord Assemblies	B.82
Jumper Troughs	B.83
GP6™ PLUS Termination Tools and Accessories	B.83
Pan-Punch® 110 Category 5e System Kits	B.84
19" Punchdown Rack Mount Panels	B.85
Pan-Punch® Category 5e 19" Rack Mount Panels	B.85
Pan-Punch® Category 5e 19" Rack Mount Panel Kits	B.86
Pan-Punch® 110 Category 5e Tower System	B.86
Component Labels for Pan-Punch® 110 Category 5e Tower Systems	B.87
Vertical Cable Managers for Tower Systems	B.87
110 Punchdown Label Holder	B.87
Component Labels for 110 Punchdown Designation Label Holders	B.88
19" Rack Mount Bracket Kits	B.88
Pan-Punch® 110 Category 5e Connecting Blocks	B.88
Pan-Punch® 110 Category 5e Bases	B.89
Pan-Punch® 110 Patch Connectors	B.89
Pan-Punch® 110 Patch Cords Assemblies	B.90
Labels for Pan-Punch® 110 Patch Cord Assemblies	B.90
Jumper Troughs	B.91
Pan-Punch® Punchdown Tools and Accessories	B.91
RJ45 Jack Blockout Device	B.92
★ USB Blockout Device	B.93
RJ45 Plug Lock-in Device	B.94
Self-Laminating Cable Marker Holders for Large Cables or Cable Bundles	B.95
Component Labels for Self-Laminating Cable Markers for Large Cables or Cable Bundles	B.95
Thermal Transfer Marker Plates	B.96
Patch Cord Color Bands	B.96
Cable Prep Tools	B.97
Module Termination Tools and Accessories	B.97
Patch Cord Removal Tool	B.98
Modular Plug Termination Tools	B.98

Fiber Optic Systems

Fiber Optic Systems	C.1
Fiber Optic Systems Roadmaps	C.2 – C.3
Opti-Core® Fiber Optic Distribution Cable	C.4 – C.5

★ Represents new product offering.

Index by NameLabels for Opti-Core[®] Fiber Optic Distribution Cable C.5Opti-Core[®] Fiber Optic Indoor Interlocking Armored Cable C.6 – C.7Labels for Opti-Core[®] Fiber Optic Indoor Interlocking Armored Cable C.7Opti-Core[®] Gel-Free Fiber Optic Indoor/Outdoor All-Dielectric Cable C.8 – C.9Labels for Opti-Core[®] Gel-Free Fiber Optic Indoor/Outdoor All-Dielectric Cable C.10Opti-Core[®] Gel-Free Optic Indoor/Outdoor Interlocking Armored Cable C.11 – C.12Labels for Opti-Core[®] Gel-Free Optic Indoor/Outdoor Interlocking Armored Cable C.13Opti-Core[®] Gel-Free Fiber Optic Outside Plant All-Dielectric Cable C.14Labels for Opti-Core[®] Gel-Free Optic Outside Plant All-Dielectric Cable C.15Opti-Core[®] Gel-Free Fiber Optic Outside Plant Armored Cable C.16Labels for Opti-Core[®] Gel-Free Fiber Optic Outside Plant Armored Cable C.17Opti-Core[®] Fiber Optic Interconnect Cable C.18Labels for Opti-Core[®] Fiber Optic Interconnect Cable C.18LC OptiCam[®] Fiber Optic Connectors – Pre-Polished Cam Termination C.19Keyed LC OptiCam[®] Fiber Optic Connectors – Pre-Polished Cam Termination C.20 – C.21SC OptiCam[®] Fiber Optic Connectors – Pre-Polished Cam Termination C.22ST OptiCam[®] Fiber Optic Connectors – Pre-Polished Cam Termination C.23

LC Fiber Optic Connectors – Field Polish Termination C.24 – C.25

SC Fiber Optic Connectors – Field Polish Termination C.26

ST Fiber Optic Connectors – Field Polish Termination C.27

250 Micron Fiber Build-Up Tube Kit C.27

Furcation Kits C.28

Fan-Out Kits C.28

LC Sr./Sr. Fiber Optic Adapters C.28

LC Sr./Jr. Fiber Optic Adapters C.29

SC Fiber Optic Adapters C.30

ST Fiber Optic Adapters C.31

★ MPO Mini-Com[®] Fiber Optic Adapter Module C.31LC Sr./Sr. Mini-Com[®] Fiber Optic Adapter Modules C.32LC Sr./Jr. Mini-Com[®] Fiber Optic Adapter Modules C.33Keyed LC Mini-Com[®] Fiber Optic Adapter Modules C.34SC Mini-Com[®] Fiber Optic Adapter Modules C.35ST Mini-Com[®] Fiber Optic Adapter Modules C.36Mini-Com[®] Fiber Cable Strain Relief Module C.36Mini-Com[®] Blank Module C.36★ QuickNet[™] Fiber Optic Migration Adapter Panels (FAPs) C.37★ Opticom[®] MPO Fiber Optic Adapter Panels (FAPs) C.38LC Opticom[®] Fiber Adapter Panels (FAPs) C.39Keyed LC Opticom[®] Fiber Adapter Panels (FAPs) C.40SC Opticom[®] Fiber Adapter Panels (FAPs) C.41 – C.42ST Opticom[®] Fiber Adapter Panels (FAPs) C.43Opticom[®] Multimedia Modular Panel (FMP) C.43Opticom[®] Blank Fiber Adapter Panel (FAP) C.43QuickNet[™] SFQ Series MTP* Fiber Optic Cassettes C.44 – C.45QuickNet[™] HDQ Series High Density Fiber Optic Cassettes C.46QuickNet[™] MTP* Fiber Optic Cassettes C.47 – C.48Keyed LC QuickNet[™] MTP* Fiber Optic Cassettes C.49 – C.53Opticom[®] QuickNet[™] Rack Mount Fiber Cassette Enclosures C.54Opticom[®] Rack Mount Fiber Enclosures C.55Opticom[®] Rack Mount Fiber Trays C.56Opticom[®] Fiber Adapter Patch Panels C.56Opticom[®] Zero RU Cable Management Solutions C.57QuickNet[™] Patch Panels and Accessories C.58Mini-Com[®] Modular Faceplate Patch Panels C.59Component Labels for Mini-Com[®] Modular Faceplate Patch Panels C.59Opticom[®] Wall Mount Enclosures C.60Opticom[®] Fiber Slack Management Accessories C.61Opticom[®] Splice Modules, Trays, and Holders C.62Opti-Core[®] 10Gig[™] 50/125µm (OM3/OM4) Patch Cords and Pigtails C.63 – C.64Cable Self-Laminating Labels for Opti-Core[®] 10Gig[™] 50/125µm (OM3/OM4) Fiber Optic Patch Cords and Pigtails C.64Opti-Core[®] Multimode 62.5/125µm (OM1) or 50/125µm (OM2) Fiber Optic Patch Cords and Pigtails C.65 – C.66Cable Self-Laminating Labels for Opti-Core[®] Multimode 62.5/125µm (OM1) or 50/125µm (OM2) C.65 – C.66

Fiber Optic Patch Cords and Pigtails C.67

Opti-Core[®] Singlemode 9/125µm (OS1/OS2) Fiber Optic Patch Cords and Pigtails C.68 – C.69Cable Self-Laminating Labels for Opti-Core[®] Singlemode 9/125µm (OS1/OS2) Fiber Optic Patch Cords and Pigtails C.70Opti-Core[®] APC 9/125µm (OS1/OS2) Fiber Optic Patch Cords and Pigtails C.71Cable Self-Laminating Labels for Opti-Core[®] APC 9/125µm (OS1/OS2) Fiber Optic Patch Cords and Pigtails C.71Keyed Opti-Core[®] 10Gig[™] 50/125µm (OM3) Fiber Optic Patch Cords and Pigtails C.72 – C.74Cable Self-Laminating Labels for Keyed Opti-Core[®] 10Gig[™] 50/125µm (OM3) Fiber Optic Patch Cords and Pigtails C.74

★ Represents new product offering.

*MTP is a registered trademark of US Conec Ltd.

Index by Name

Keyed Opti-Core® Multimode 62.5/125µm (OM1) or 50/125µm (OM2) Fiber Optic Patch Cords and Pigtails	C.75 – C.77
Cable Self-Laminating Labels for Keyed Opti-Core® Multimode 62.5/125µm (OM1) or 50/125µm (OM2) Fiber Optic Patch Cords and Pigtails	C.78
Keyed Opti-Core® Singlemode 9/125µm (OS1/OS2) Patch Cords and Pigtails	C.79 – C.80
Cable Self-Laminating Labels for Keyed Opti-Core® Singlemode 9/125µm (OS1/OS2) Patch Cords and Pigtails	C.81
★ LC Lock-In Duplex Clip	C.82
LC Duplex Adapter Blockout Device	C.82
★ SC Duplex Adapter Blockout Device	C.82
Opti-Core® Fiber Optic Reference Cable Assembly Kits	C.83 – C.85
Opti-Core® Fiber Optic Reference Cable Assemblies	C.86 – C.89
LabelCore™ Fiber Optic Cable Identification System	C.90
Self-Laminating Labels for LabelCore™ Fiber Optic Cable Identification System	C.90
QuickNet™ Hydra Cable Assemblies	C.91
Cable Self-Laminating Labels for QuickNet™ Hydra Cable Assemblies	C.92
QuickNet™ MTP* Interconnect Cable Assemblies – Multimode 10Gig™ 50/125µm (OM3 and OM4)	C.92
Cable Labels for QuickNet™ MTP* Interconnect Cable Assemblies – Multimode 10Gig™ 50/125µm (OM3)	C.93
QuickNet™ MTP* Interconnect Cable Assemblies – Multimode 50/125µm (OM2)	C.93
Cable Labels for QuickNet™ MTP* Interconnect Cable Assemblies – Multimode 50/125µm (OM2)	C.93
QuickNet™ MTP* Interconnect Cable Assemblies – Multimode 62.5/125µm (OM1)	C.94
Cable Labels for QuickNet™ MTP* Interconnect Cable Assemblies – Multimode 62.5/125µm (OM1)	C.94
QuickNet™ MTP* Interconnect Cable Assemblies – Singlemode 9/125µm (OS1/OS2)	C.95
Cable Labels for QuickNet™ MTP* Interconnect Cable Assemblies – Singlemode 9/125µm (OS1/OS2)	C.95
★ QuickNet™ MTP* Interconnect Round Cable Assemblies – Multimode 10Gig™ 50/125µm (OM3 and OM4)	C.96
★ QuickNet™ MTP* Interconnect Round Cable Assemblies – Singlemode 9µm (OS1/OS2)	C.96
QuickNet™ MTP* Trunk Cable Assemblies	C.97 – C.98
Opti-Core® Traditional Trunk Cable Assemblies	C.99 – C.100
OptiCam® Pre-Polished Cam Fiber Optic Termination Kits	C.101
Components for OptiCam® Pre-Polished Cam Termination Kits	C.101
Opti-Crimp® Pre-Polished Crimp Fiber Optic Termination Kits	C.102
Components for Opti-Crimp® Pre-Polished Crimp Termination Kits	C.102
Field Polish Fiber Optic Termination Kits	C.103
Components for Field Polish Fiber Optic Termination Kits	C.104
MTP* Connector Cleaning Tools	C.105
Patch Cord Removal Tool	C.105
Opticom® High-Density Connector and Patch Cord Removal Tool	C.106

Power over Ethernet Systems

Power over Ethernet Systems	D.1
Power over Ethernet Systems Roadmap	D.2
DPoE™ Power Patch Panel	D.3
Component Labels for DPoE™ Power Patch Panel	D.3
DPoE™ Power Midspan	D.4
Component Labels for DPoE™ Power Midspan	D.4
DPoE™ Power Supply	D.5
DPoE™ Power System	D.5

PanZone® Zone Cabling Systems

PanZone® Zone Cabling Systems	E.1
Zone Cabling Systems Roadmap	E.2
PanZone® In-Ceiling Enclosures	E.3
PanZone® Wall Mount Cabinets	E.4
PanZone® Active Wall Mount Enclosure	E.5
PanZone® Building Automation Systems Enclosure	E.5
Consolidation Point Boxes	E.6
PanZone® Work Area Raised Floor Consolidation Point Enclosures	E.6
PanZone® Overhead Distribution Racks	E.6
PanZone® Raised Floor Enclosures	E.7
Punchdown Consolidation Point Enclosures	E.8
PanZone® Wall Mount Consolidation Point Enclosures	E.8
PanZone® Cable Assemblies	E.9
Cable Labels for PanZone® Cable Assemblies	E.10

Wireless Solutions

Wireless Solutions	F.1
Wireless Solution Roadmap	F.2
PanZone® Wireless Access Point Enclosures	F.3 – F.4
PanZone® NEMA 4X/IP66 Rated Wireless Access Point Enclosures	F.5

★ Represents new product offering.

*MTP is a registered trademark of US Conec Ltd.

Index by Name**Outlets**

	Outlets	G.1
	Workstation Roadmap	G.2
	Mini-Com [®] Ultimate ID [®] Classic Series Faceplates	G.3
	Mini-Com [®] Classic Series Faceplates with Label and Label Cover	G.3
	Component Labels for Mini-Com [®] Classic Series Faceplates with Label and Label Cover	G.4
	Mini-Com [®] Classic Series Sloped Faceplates with Label and Label Cover	G.4
	Component Labels for Mini-Com [®] Classic Series Sloped Faceplates with Label and Label Cover	G.4
	Mini-Com [®] Classic Series Faceplates	G.5
	Component Labels for Mini-Com [®] Classic Series Faceplates	G.5
	Mini-Com [®] Classic Series Faceplates Kits	G.5
	Component Labels for Mini-Com [®] Classic Series Faceplates Kits	G.6
	Mini-Com [®] Ultimate ID [®] Executive Series Faceplates	G.6
	Mini-Com [®] Executive Series Faceplates	G.7
	Component Labels for Mini-Com [®] Executive Series Faceplates	G.7
	Mini-Com [®] Sloped Executive Series Faceplates Kit	G.7
	Component Labels for Mini-Com [®] Sloped Executive Series Faceplates Kit	G.8
	Mini-Com [®] Executive Series Faceplates Kits with Jack Modules	G.8
	Component Labels for Mini-Com [®] Executive Series Faceplates Kits with Jack Modules	G.9
	Mini-Com [®] Ultimate ID [®] Tamper Resistant Faceplate Kit	G.9
	Mini-Com [®] Tamper Resistant Faceplates	G.10
	Component Labels for Mini-Com [®] Tamper Resistant Faceplates	G.10
	Mini-Com [®] Water Resistant Faceplate	G.11
	Component Labels for Mini-Com [®] Water Resistant Faceplate	G.11
	Mini-Com [®] Ultimate ID [®] Stainless Steel Faceplates	G.11
	Mini-Com [®] Stainless Steel Faceplates with Labels	G.12
	Component Labels for Mini-Com [®] Stainless Steel Faceplates with Labels	G.12
	Mini-Com [®] Stainless Steel Faceplates	G.13
	Component Labels for Mini-Com [®] Stainless Steel Faceplates	G.13
	Mini-Com [®] Classic and Executive Faceplates Frames	G.14
	Component Labels for Mini-Com [®] Classic and Executive Faceplate Frames	G.14
	Mini-Com [®] Inserts	G.15
	Component Labels for Mini-Com [®] Inserts	G.15
	Mini-Com [®] In-Wall Fiber Spool	G.16
	Mini-Com [®] "GFCI" Decora Module Frames	G.16
	Component Labels for Mini-Com [®] "GFCI" Decora Module Frames	G.16
	Mini-Com [®] 106 Duplex Module Frames	G.17
	Phone Plate with Module	G.17
	Component Labels for Keystone Phone Plate with Module	G.17
	Wall Board Adapters	G.17
	In-Wall Box Adapters	G.18
	Tombstone Floor Box Adapter Plate	G.18
	Mini-Com [®] Ultimate ID [®] Modular Furniture Faceplate	G.18
	Mini-Com [®] Snap-On Modular Furniture Faceplates	G.19
	Component Labels for Mini-Com [®] Snap-On Modular Furniture Faceplates	G.20
	Mini-Com [®] Round Faceplates	G.20
	Component Labels for Mini-Com [®] Round Faceplates	G.20
	Mini-Com [®] One Position Adapters	G.21
	Mini-Com [®] Ultimate ID [®] Hybrid Box	G.22
	Mini-Com [®] Ultimate ID [®] Surface Mount Boxes	G.22
	Mini-Com [®] Surface Mount Boxes	G.23
	Component Labels for Mini-Com [®] Surface Mount Boxes	G.23
	Mini-Com [®] Shuttered Surface Mount Boxes	G.24
	Component Labels for Mini-Com [®] Shuttered Surface Mount Boxes	G.24
	Mini-Com [®] Ultimate ID [®] Multi-Media/Fiber Surface Mount Box	G.25
	Mini-Com [®] Multi-Media/Fiber Surface Mount Boxes	G.25
	Component Labels for Mini-Com [®] Multi-Media/Fiber Surface Mount Boxes	G.26
	Mini-Com [®] MuTOA 6-Port Outlet Box	G.26
	Component Labels for Mini-Com [®] MuTOA 6-Port Outlet Boxes	G.26
	Optional Magnets	G.27
	Ultimate ID [®] Icons	G.27
	Ultimate ID [®] Replacement Label Covers and Screw Covers	G.27
	Ultimate ID [®] Write-On Labels	G.28
	Icons	G.28
	Replacement Screw Cover	G.28
	Replacement Label/Label Cover Kits	G.29
	Low Voltage Mounting Brackets	G.29
	Depth to Rear of Module Reference Guide	G.30

★ Represents new product offering.

Index by Name

Media Distribution System

Media Distribution System	H.1
Media Distribution Enclosures System Roadmap	H.2
Media Distribution Enclosures	H.3
Media Distribution Voice Hubs	H.4
Media Distribution Video Splitters	H.4
Media Distribution Data Hub	H.5
Media Distribution Accessories	H.5

Physical Infrastructure Management Systems

Physical Infrastructure Management Systems	I.1
PanView iQ™ Interconnect Solution for the Enterprise	I.2
PanView iQ™ Interconnect Solution for the Data Center	I.2
PanView iQ™ Cross-Connect Solution for the Enterprise	I.3
PanView iQ™ Cross-Connect Solution for the Data Center	I.3
PanView iQ™ Hardware Exploded View and PanView iQ™ Interface Unit	I.4
Recommended PanView iQ™ 96-Port Configuration (Rear View)	I.4
Physical Infrastructure Management System Roadmap	I.5
★ Physical Infrastructure Manager™ (PIM™) Software Platform	I.6
PanView iQ™ Patch Panels	I.7
Component Labels for PanView iQ™ Patch Panels	I.8
PanView iQ™ Patch Panels Fiber Trays	I.8
PanView iQ™ Intelligence Modules	I.9
PanView iQ™ Power Supply	I.9
PanView iQ™ Patch Cords	I.10 – I.11
Labels for PanView iQ™ Patch Cords	I.11

Overhead and Underfloor Routing

FiberRunner® Routing Systems	J.1
24x4 Routing System Roadmap	J.2 – J.3
24x4 FiberRunner® Routing System	J.4
24x4 FiberRunner® Routing System – Channel and Cover	J.4
24x4 FiberRunner® QuikLock™ Coupler	J.4
24x4 FiberRunner® System Fittings	J.5 – J.6
24x4 FiberRunner® System Spillouts	J.7 – J.8
24x4 FiberRunner® Mounting Brackets	J.9
12x4 Routing System Roadmap	J.10 – J.11
12x4 FiberRunner® Routing System	J.12
12x4 FiberRunner® Routing System – Channel and Cover	J.12
12x4 FiberRunner® QuikLock™ Coupler	J.13
12x4 FiberRunner® System Fittings	J.13 – J.16
12x4 FiberRunner® System Spillouts	J.17 – J.19
12x4 FiberRunner® Mounting Brackets	J.20 – J.22
6x4 Routing System Roadmap	J.23 – J.24
6x4 FiberRunner® Routing System	J.25
6x4 FiberRunner® Routing System – Channel and Covers	J.25
6x4 FiberRunner® QuikLock™ Coupler	J.26
6x4 FiberRunner® System Fittings	J.26 – J.28
6x4 FiberRunner® System Spillouts	J.29 – J.32
4x4 and 6x4 FiberRunner® Mounting Brackets	J.33 – J.35
Adapters to Other Systems	J.36 – J.37
4x4 Routing System Roadmap	J.38 – J.39
4x4 FiberRunner® Routing System	J.40
4x4 FiberRunner® Routing System – Channel and Covers	J.40
4x4 FiberRunner® QuikLock™ Coupler	J.41
4x4 FiberRunner® System Fittings	J.41 – J.43
4x4 FiberRunner® System Spillouts	J.44 – J.46
FiberRunner® Accessories	J.47 – J.48
2x2 Routing System Roadmap	J.50 – J.51
2x2 FiberRunner® Routing System	J.52
2x2 FiberRunner® Routing System – Channels and Cover	J.52
2x2 FiberRunner® QuikLock™ Coupler	J.53
2x2 FiberRunner® System Fitting	J.53
2x2 FiberRunner® System Spillouts	J.54
Fiber-Duct™ Routing Systems	J.55
2x2 and 4x4 Fiber-Duct™ Routing Systems Roadmap	J.56 – J.57
2x2 and 4x4 Fiber-Duct™ Routing Systems	J.58 – J.59

★ Represents new product offering.

Index by Name

Fiber-Duct™ System FittingsJ.60
 Fiber-Duct™ SpilloutsJ.61
 Fiber-Duct™ Bend Radius Control TrumpetsJ.62
 Fiber-Duct™ AccessoriesJ.62
 Fiber-Duct™ Mounting BracketsJ.63 – J.64

Wyr-Grid™ Overhead Cable Tray Routing System**J.65**
 Wyr-Grid™ Overhead Cable Tray Routing System RoadmapJ.66
 Wire Fill for Wyr-Grid™ Overhead Cable Tray Routing SystemJ.67

Wyr-Grid™ Pathway SectionsJ.67
 Wyr-Grid™ Splice ConnectorsJ.68
 Wyr-Grid™ WaterfallsJ.68
 Wyr-Grid™ Support BracketsJ.69
 Wyr-Grid™ Mounting Brackets for FiberRunner® SystemJ.70
 Wyr-Grid™ AccessoriesJ.71

StructuredGround™ Grounding System for Wyr-Grid™ SystemJ.72
 Wyr-Grid™ Tools and HardwareJ.73
GridRunner™ Underfloor Cable Routing System**J.75**
 GridRunner™ Underfloor Cable Routing System RoadmapJ.76
 GridRunner™ Underfloor Cable Routing SystemJ.77

GridRunner™ Wire BasketsJ.77 – J.78
 GridRunner™ Pedestal BracketJ.79
 GridRunner™ AccessoriesJ.79

Surface Raceway

Surface Raceway**K.1**
 Panduit® Pan-Way® Non-Metallic Surface Raceway SolutionsK.2
 Panduit® Pan-Way® Non-Metallic Surface Raceway SolutionsK.3

Office Furniture Raceway RoadmapK.4 – K.5
 Office Furniture ConfigurationsK.6 – K.7
 Pan-Way® Office Furniture Raceway SystemK.8
 Pan-Way® Office Furniture Raceway FittingsK.8 – K.11
 Cable Fill Capacities for Office FurnitureK.12

LD Profile Raceway RoadmapK.14 – K.15
 LD ConfigurationsK.16 – K.17
 Pan-Way® LD Surface Raceway SystemK.18
 Standard Fittings for Low Voltage ApplicationsK.19
 One Inch Bend Radius Fittings for TIA/EIA ComplianceK.20

Cable Fill Capacities for LD RacewayK.21
 Panduit® Mini-Com® Ultimate ID® Sloped Snap-On FaceplatesK.22
 Component Labels for Mini-Com® Ultimate ID® Sloped Snap-On Faceplates for Use with Panduit® Mini-Com® ModulesK.22
 Pan-Way® Classic Series Snap-On Faceplates for Use With Panduit® Mini-Com® ModulesK.23
 Component Labels for Pan-Way® Classic Series Snap-On Faceplates for Use with Panduit® Mini-Com® ModulesK.24
 Pan-Way® Low Voltage Surface Mount Outlet BoxesK.25 – K.26

Cabinets, Racks, and Cable Management Solutions

Pre-Configured Physical Infrastructures, Cabinets, Racks, and Cable Management Solutions**L.1**
 Panduit Pre-Configured Physical Infrastructures for Cisco^ UCS, Nexus, and Catalyst PlatformsL.2
 Panduit Pre-Configured Physical Infrastructure for Cisco^ Unified Computing Systems (UCS)L.3
 Panduit Pre-Configured Physical Infrastructure for the Cisco^ Nexus 7010 SwitchL.4
 Panduit Pre-Configured Physical Infrastructure for the Cisco^ Catalyst 6509 SwitchL.5
 Panduit Pre-Configured Physical Infrastructure for the Cisco^ Nexus 7009 SwitchL.6
 Net-Access™ Cabinet SystemL.7
 Net-Access™ Cabinet ApplicationsL.8
 Net-SERV™ Cabinet SystemL.9
 Net-Access™ Switch Cabinets RoadmapL.10 – L.11
 Net-Access™ Switch CabinetsL.12 – L.15
 Cisco® Nexus 7018 Cabinet SolutionL.16
 Net-Access™ 7010 Switch CabinetsL.17 – L.18
 Net-Access™ Server Cabinet System RoadmapL.19
 Net-Access™ Server CabinetsL.20 – L.22
 Net-Access™ Vertical Exhaust System RoadmapL.23
 ★ Net-Contain™ Cold Aisle Containment SystemL.24
 ★ Integral Low Profile Ceiling StructureL.24
 ★ End of Row Dual Sliding Door SolutionL.24
 Thermal Ducting SolutionsL.25
 Inlet DuctsL.25
 Exhaust DuctsL.25

★ Represents new product offering.

Index by Name

CabRunner™ Overhead Cable Routing System	L.26
Net-SERV™ Cabinets	L.27
Basic Configuration	L.27
Standard Density Cable Management Configuration	L.28
Vertical Patch Cable Management Configuration	L.29
High Density Cable Management Configuration	L.30
Configuration for Vertical Exhaust Duct and High Density Management	L.31
Vertical Exhaust Ducting	L.31
Net-SERV® Doors and Floor Sealing Assemblies	L.31
Net-SERV® Colocation Cabinet	L.32
Net-SERV™ Accessories	L.32 – L.33
Top of Cabinet Air Sealing Accessories	L.34
★ Power and Environmental Management	L.35
Basic and Metered Power Outlet Units	L.35 – L.44
Auto Transfer Switch (ATS) Units	L.45
Networked Power Outlet Units	L.46 – L.49
Networked and Environmental Power Outlet Units	L.50 – L.52
Switched with Per Outlet Monitoring Power Outlet Units	L.53 – L.55
Environmental Sensors	L.56
Power Cords	L.57 – L.58
Power Cord Retainers	L.58
4 Post Rack System Roadmap	L.59
4 Post Cable Management Rack System and Accessories	L.60 – L.62
2 Post Cable Management Rack System and Accessories	L.63 – L.64
PatchRunner™ High Capacity Vertical Cable Management System – Cable Capacity Chart	L.65
PatchRunner™ High Capacity Vertical Cable Managers Roadmap	L.66
PatchRunner™ High Capacity Vertical Cable Management System	L.67 – L.68
PatchRunner™ Vertical Cable Management System – Cable Capacity Chart	L.69
PatchRunner™ Vertical Cable Management Rack System Roadmap	L.70
PatchRunner™ Vertical Cable Management System	L.71 – L.72
NetRunner™ High Capacity Vertical Cable Management System Roadmap	L.73
NetRunner™ High Capacity Vertical Cable Managers	L.74
NetRunner™ Vertical Cable Management	L.75
Horizontal Cable Management Rack Systems	L.76
PatchLink™ Horizontal Cable Managers	L.77
NetManager™ High Capacity Horizontal Cable Managers	L.78
NetManager™ Horizontal Cable Managers	L.79
PatchRunner™ High Capacity Horizontal Cable Managers	L.80
Open-Access™ Horizontal Cable Managers	L.81
Vertical D-Rings	L.82
Cable Routing Troughs	L.82
Rack Mount Shelves	L.83
Panel Extender Brackets	L.83
Rack Mount Cable Management Accessories	L.84
Hinged Wall Brackets	L.84
Full-Length Blanking Shade	L.85
Tool-Less Blanking Panels	L.85
Rack Filler Panels	L.85
Angled Panel Accessories	L.86
IN-Cabinet Vertical Cable Managers	L.86
Communication Cable Management Kit for Cabinets	L.87
Pan-Post™ Standoffs	L.88
Bundle Retainers	L.88
Cable Management Accessories Roadmap	L.89
Cool Boot™ Raised Floor Air Sealing Grommet	L.90 – L.91
J-Pro™ Cable Support System	L.92 – L.94
Metal Stud Grommets and Accessories	L.94
Color Option Chart	L.95
J-Mod® Cable Support System	L.96 – L.97
Conduit Waterfall	L.98
Waterfall Accessories	L.98
Double Waterfall Accessory	L.99
Threaded Rod Cover	L.99
Stackable Cable Rack Spacers	L.100

Grounding and Bonding

Grounding and Bonding	M.1
The Purpose of Grounding and Bonding	M.2

★ Represents new product offering.

Index by Name

What are the Effects of Improper Grounding?M.2

Can You Afford Improper Grounding?M.3

Common Bonding Network (CBN) RoadmapM.4

Service Entrance Grounding RoadmapM.5

Telecommunications Room Grounding RoadmapM.6

Access Floor Mesh Common Bonding Network (MCBN) RoadmapM.7

Data Center Rack and Cabinet Grounding RoadmapM.8 – M.9

Selection Guide – StructuredGround™ Kits for Net-Access™ CabinetsM.10 – M.11

Selection Guide – StructuredGround™ Kits for RacksM.12 – M.13

Features and Benefits – StructuredGround™ Kits for CabinetsM.14

Features and Benefits – StructuredGround™ Kits for RacksM.15

Access Floor Grounding ClampsM.16

Split Bolt Quad Clamp, BronzeM.16

Common Bonding Network (CBN) Jumper KitsM.16

Grounding Strip KitsM.17

Grounding Busbar KitsM.17

Front to Back Rail Jumper KitsM.18

Equipment Jumper KitsM.19

Surge Suppressor Jumper KitM.20

Armored Cable Grounding KitM.20

Telecommunication Equipment Bonding Conductor (TEBC) KitsM.21 – M.22

Enclosure Grounding KitM.23

Shielded Jack Module Grounding KitM.23

Electrostatic Discharge (ESD) Port Kits and Wrist StrapM.24

Bonding ScrewsM.25

Bonding Cage NutM.25

Thread-Forming ScrewsM.25

Paint Piercing Grounding Washer KitM.26

Bonding Hardware KitsM.26

Retrofit Cabinet Grounding KitsM.27

Retrofit Rack Grounding KitsM.28

BICSI/TIA-607-B Telecommunications Grounding BusbarsM.29

Component Labels for BICSI/TIA-607-B Telecommunications Grounding BusbarsM.29

NEMA Hole Pattern Grounding BusbarsM.30

Grounding Busbar 1 Inch Hole SpacingsM.30

Universal Beam Grounding ClampM.31

Auxiliary Cable Brackets and JumpersM.31

One-Hole Grounding Lay-In LugM.32

Ring Terminal, Vinyl Expanded InsulationM.33

Ring Terminal, Nylon Insulated – Funnel EntryM.34

Multiple Stud Terminal, Nylon InsulatedM.34

Ring Terminal, Non-InsulatedM.35

Code Conductor, Two-Hole, Long Barrel with Window LugM.36 – M.38

Flex Conductor, Two-Hole, Long Barrel with Window LugM.39 – M.40

Code/Flex Conductor HTAPM.41

Clear Covers for HTCT HTAPsM.42

Code/Flex Conductor HTAP KitsM.42

Code Conductor, Thin Wall, Tin-Plated, CTAPFM.43

Grounding Clamp, U-Bolt, BronzeM.44

Grounding Clamp for Water Pipes, BronzeM.44

Grounding Clamp for Water Pipes, AluminumM.45

Split Bolt, CopperM.45

Hand Operated Plier Type ToolsM.46

Contour Crimp™ Controlled Cycle ToolsM.46

Die Type, Manual Hydraulic, 14 Ton, Crimping ToolM.47

Die Type, Lithium-Ion Battery Powered Hydraulic, 14 Ton, Crimping ToolsM.48

CD-920 Crimping DiesM.49

Installation Tooling and Die Selections for Type LCC-WM.50 – M.53

Installation Tooling and Die Selections for Type LCCXM.54 – M.55

Installation Tooling and Die Selections for Type CTAPFM.56 – M.57

Installation Tooling and Die Selections for Type HTCTM.58

Industrial**Industrial** **N.1**

Industrial System Roadmap N.2

★ IndustrialNet™ Ethernet Enclosure, Rack, and Accessories N.3 – N.4

IndustrialNet™ TX6™ Connectors N.5

IndustrialNet™ TX6™ Coupler N.5

★ Represents new product offering.

Index by Name

IndustrialNet™ TX6™ PLUS Patch Cords	N.6
IndustrialNet™ TX5e™ Connectors	N.6
IndustrialNet™ TX5e™ Coupler	N.7
IndustrialNet™ USB Coupler	N.7
IndustrialNet™ TX5e™ Modular Plugs	N.7
IndustrialNet™ TX5e™ Patch Cords	N.8
IndustrialNet™ LC Fiber Optic Bulkhead Adapter and Patch Cord	N.8
IndustrialNet™ Data Access Port	N.9
IndustrialNet™ Stainless Steel Faceplates	N.9
Component Labels for IndustrialNet™ Stainless Steel Faceplates	N.9

Labeling and Identification

Labeling and Identification	O.1
PanTher™ LS8E Hand-Held Thermal Transfer Printer and Accessories	O.2
Cougar™ LS9 Hand-Held Thermal Transfer Printer and Accessories	O.2
P1™ Network Component Label Cassettes for PanTher™ LS8E Hand-Held Thermal Transfer Printer	O.3 – O.4
P1™ Self-Laminating Label Cassettes for PanTher™ LS8E Hand-Held Thermal Transfer Printer	O.5
★ P1™ Turn-Tell™ Label Cassettes for PanTher™ LS8E Hand-Held Thermal Transfer Printer	O.6
★ P1™ Marker Plate Label Cassettes for PanTher™ LS8E Hand-Held Thermal Transfer Printer	O.6
★ P1™ Flag Label Cassettes for PanTher™ LS8E Hand-Held Thermal Transfer Printerlag Label Cassettes	O.6
★ P1™ Die-Cut Nylon Cloth Labels for PanTher™ LS8E Hand-Held Thermal Transfer Printer	O.7
★ P1™ Continuous Nylon Cloth Tape for PanTher™ LS8E or Cougar™ LS9 Hand-Held Thermal Transfer Printers	O.7
P1™ Die-Cut Heat Shrink Label Cassettes for PanTher™ LS8E Hand-Held Thermal Transfer Printer	O.8
P1™ Continuous Heat Shrink Label Cassettes for PanTher™ LS8E and Cougar™ LS9 Hand-Held Thermal Transfer Printers	O.9
P1™ Continuous Tape Cassettes for PanTher™ LS8E and Cougar™ LS9 Hand-Held Thermal Transfer Printers	O.10
P1™ Ultimate ID® Label Cassette for use with PanTher™ LS8E and Cougar™ LS9 Hand-Held Thermal Transfer Printers	O.11
Easy-Mark™ Labeling Software	O.11
CAD-Connect™ Labeling Software	O.12
★ TDP43ME Thermal Transfer Desktop Printer and Accessories	O.12
★ Ribbons for Use with the TDP43ME Thermal Transfer Desktop Printer	O.13
Thermal Transfer Component Labels	O.14 – O.15
Thermal Transfer Self-Laminating Labels	O.16 – O.17
LabelCore™ Fiber Optic Cable Identification Sleeves	O.18
Self-Laminating Labels for use with LabelCore™ Fiber Optic Cable Identification System	O.18
★ Turn-Tell® Labels	O.19 – O.20
Thermal Transfer Marker Plates	O.20
★ Thermal Transfer Flag Labels	O.20
Thermal Transfer Raised Panel Labels	O.21
Ultimate ID® Network System Laser/Ink Jet Labels	O.21
Laser/Ink Jet Component Labels	O.22
Laser/Ink Jet Self-Laminating Labels	O.23 – O.24
Wire Size Selection Guide	O.25
Self-Laminating Fiber Optic Cable Marker Tags	O.26
Photoluminescent Safety Signs	O.26
Arc Flash Pre-Printed Labels	O.27
Arc Flash Pre-Printed Labels with PPE Listings	O.28
Arc Flash Print On-Demand Labels	O.28
Voltage and Fiber Optic Markers	O.29
Voltage and Fiber Optic Snap-On Markers (Non-Adhesive)	O.30
Photoluminescent Tapes – Thermal Transfer Printable	O.30

Cable Management Accessories

Wiring Duct	P.1
Wiring Duct for Backboard Mounted Applications Roadmap	P.2
Wiring Duct for Cord Management at the Workstation Roadmap	P.3
★ Panduct® PanelMax™ Shielded Wiring Duct	P.4
Panduct® PanelMax™ Noise Shield	P.4
Panduct® Type H – Hinged Cover Wiring Duct	P.5
Panduct® Type HN Hinged Cover Narrow Slot Wiring Duct	P.6
Panduct® Type HS Hinged Cover Solid Wall Raceway	P.7
Panduct® Type NNC Halogen-Free Metric Wiring Duct	P.8
Panduct® Type NNC Divider Wall	P.8
Panduct® Type TNC Low-Smoke, Halogen-Free Slotted Wall Wiring Duct	P.9
Panduct® Type G – Wide Slot Wiring Duct	P.10
Panduct® Type FS Solid Wall Raceway	P.11
Panduct® Type FL Flexible Wiring Duct	P.12
Panduct® Type G and H Wiring Duct Wire Retainers	P.12

★ Represents new product offering.

Index by Name

Panduct® Divider Wall	P.13
Adhesive Tape	P.13
Specifications For Tape Application	P.13
Panduct® Duct Corner Strips with 1" Bend Radius Control	P.14
Cutting Guide for Duct Corner Strips	P.14
Fiber-Duct™ Bend Radius Control Trumpets	P.14
Panduct® Installation Tools	P.15
Panduct® Type HN, H, and HS Wiring Duct – Wirefill Capacity	P.15
Panduct® Shielded Wiring Duct – Wirefill Capacity	P.15
Panduct® Type G and FS Wiring Duct – Wirefill Capacity	P.16
Panduct® Type FL Wiring Duct – Wirefill Capacity	P.16
Wirefill Formula	P.17
Cable Ties and Accessories	P.19
Tak-Ty® Hook & Loop Cable Ties	P.20
HLTP/HLSP Hook and Loop Cable Ties – Plenum	P.21
Tak-Tape™ Hook & Loop Cable Tie Rolls	P.21
Ultra-Cinch™ Hook & Loop Cable Ties	P.22
★Tape-Ty™ Hook & Loop Cable Ties	P.22
Cable Bundle Organizing Tool	P.23
Part Number System for Tak-Ty® Hook & Loop Cable Ties	P.24
Part Number System for Ultra-Cinch™ Hook & Loop Cable Ties	P.24
Elastomeric Cable Ties	P.25
Part Number System for Elastomeric Cable Ties	P.25
Contour-Ty® Cable Ties – Nylon 6.6	P.26
Part Number System for Contour-Ty® Cable Ties	P.27
Pan-Ty® Cable Ties – Nylon 6.6	P.28
Pan-Ty® Cable Ties – HALAR [■] – Distinctive Maroon Color	P.29
Pan-Ty® Clamp Ties – Nylon 6.6	P.29
Pan-Ty® Marker and Flag Ties – Nylon 6.6	P.30
Permanent Marking Pens	P.30
Part Number System for Pan-Ty® Cable Ties	P.31 – P.32
Dura-Ty™ Cable Ties – Weather Resistant Acetal – Heavy Cross Section	P.33
Dura-Ty™ Cable Ties – Weather Resistant Acetal – Extra-Heavy Cross Section	P.33
Stackable Aerial Cable Spacer – Weather Resistant Polypropylene	P.34
Aerial Support Ties – Weather Resistant Polypropylene	P.34
Part Number System for Dura-Ty™ Cable Ties and Aerial Support Ties	P.35
Pan-Ty® Striped Cable Ties – Nylon 6.6	P.36
Telephone Cable Identification Kits	P.37
Cable Tie Tools – Tool Controlled Tension and Cut-Off	P.37
Cable Tie Tools – Installer Controlled Tension and Cut-Off	P.37
Hot Stamping Service – Custom Printed Cable Ties	P.38
Tak-Ty® Hook & Loop Cable Tie Mounts	P.39
4-Way Adhesive Backed Cable Tie Mounts	P.39
Cable Tie Mounts	P.40
Extra-Heavy Cable Tie Mounts	P.40
Push Mounts with Umbrella	P.41
Adhesive Backed Cord Clips	P.41
Clincher™ Adjustable Releasable Clamp	P.41
Bevel Entry Clips	P.42
Wire Bundle Strap	P.42
Latching Wire Clips	P.43
Fixed Diameter Cable Clamps	P.44
Optical Fiber Network Saddles	P.45
Bridle Rings and Multi-Purpose Clip	P.45
Physical Properties and Colors of Cable Accessory Materials	P.46
Abrasion Protection	P.47
Pan-Wrap™ Split Harness Wrap	P.48
Pan-Wrap™ Installation Tools	P.49
Spiral Wrap	P.49
Braided Expandable Sleeving – Polyethylene Terephthalate (PET)	P.50
Fray Resistant Braided Expandable Sleeving	P.50
Heat Shrink Flame Retardant End Caps	P.50
Corrugated Loom Tubing – Slit	P.51
Grommet Edging	P.52

■HALAR is a registered trademark of Sovay Solexis, Inc.

★Represents new product offering.

Index by Part Number

Part Number	Page Number
A	
ABM100-A-C	P.39
ABM100-A-C15	P.39
ABM100-A-D20	P.39
ABM112-A-C	P.39
ABM112-A-D20	P.39
ABM1M-A-C	P.39
ABM2S-A-C	P.39
ABM2S-A-C14	P.39
ABM2S-A-C15	P.39
ABM2S-A-C20	P.39
ABM3H-A-L	P.39
ABM3H-A-L20	P.39
ABM4H-A-L	P.39
ABMM-A-C	P.39
ABMM-A-C20	P.39
ABMT-A-C	P.39
ABMT-A-C20	P.39
ABMT-S6-C	P.39
ABMT-S6-C20	P.39
ABMT-S6-C60	P.39
ABMT-S6-C69	P.39
ACC19-A-C	P.41
ACC19-A-C20	P.41
ACC38-A-C	P.41
ACC38-A-C20	P.41
ACC62-A-C	P.41
ACC62-A-C20	P.41
ACC19-AV-M300	P.41
ACC38-AV-M300	P.41
ACC62-AV-M300	P.41
ACE48	E.6
ACG24K	M.20
ACG24K-500	M.20
ACG24KX-500	M.20
ACGK	M.20
ACGKX	M.20
ARC.68-A-Q	P.41
ARC.68-A-Q14	P.41
ARC.68-S6-Q	P.41
ARC.68-S6-Q14	P.41
AST10-5-C100	P.34
AST15-5-C100	P.34
AST20-5-C100	P.34
AST25-5-C100	P.34
AVPDB	B.97
B	
BEC38-A-L	P.42
BEC38-A-L20	P.42
BEC62-A-L	P.42
BEC62-A-L20	P.42
BEC75-A-L	P.42
BEC75-A-L20	P.42
BECP38H25-L	P.42
BECP38H25-L20	P.42
BECP75H25-L	P.42
BECP75H25-L20	P.42

Part Number	Page Number
BGN-C	M.26
BGNM6-C	M.26
BR-1.25-14WS	P.45
BR-1.5-PAF	P.45
BR-1.5-SN	P.45
BR-1.5-TW	P.45
BR-2.0-14WS	P.45
BR-2.0-PAF	P.45
BR-2.0-SN	P.45
BR-2.0-TW	P.45
BR2-1.3	L.62, P.45
BR2-1.3-A	L.62, P.45
C	
C.5LG6	P.11
C.75BL6	P.10
C.75LG6	P.11
C061X030FJC	O.3
C061X030FJJ	O.22
C061X030YPT	O.14
C1BL6	P.10
C1LG6	P.11
C1.5BL6	P.10
C1.5LG6	P.11
C100X050A0T	O.21
C100X050APT	O.21
C100X050YPT	O.14
C125X030FJC	O.3
C125X030FJJ	O.22
C125X030YPT	O.14
C138X019FJC	O.3
C138X019FJJ	O.22
C138X019Y0T	O.14
C138X019YPT	O.14
C150X030Y1C	O.3
C150X030Y1J	O.22
C150X030Y1T	O.14
C188X030FJC	O.3
C188X030FJJ	O.22
C188X030YPT	O.14
C195X040Y1C	O.3
C195X040Y1J	O.22
C195X040Y1T	O.14
C200X100A0T	O.21
C200X100APT	O.21
C200X100FJC	O.3
C200X100FJJ	O.22
C200X100Y0T	O.14
C200X100YPT	O.14
C200X400A51	O.28
C200X400YZ1	O.28
C252X030A0T	O.21
C252X030APT	O.21
C252X030FJC	O.3
C252X030FJJ	O.22
C252X030FRJ	O.22
C252X030FTJ	O.22
C252X030Y0T-P	O.14

Part Number	Page Number
C252X030Y8T-P	O.14
C252X030Y9T-P	O.14
C252X030YPT	O.14
C252X030YPT-P	O.14
C252X030YQT-P	O.14
C252X030YRT-P	O.14
C252X030YST-P	O.14
C252X030YTT-P	O.14
C252X030YUT-P	O.14
C252X030YVT-P	O.14
C252X030YWT-P	O.14
C261X030FJC	O.4
C261X030FJJ	O.22
C261X030YPT	O.15
C261X035Y1C	O.4
C261X035Y1J	O.22
C261X035Y1T	O.15
C275X125Y0T	O.15
C275X125YPT	O.15
C282X030Y1C	O.4
C282X030Y1J	O.22
C288X030YPT	O.15
C288X040Y1C	O.4
C288X040Y1J	O.22
C288X040Y1T	O.15
C2BL6	P.10
C2.5BL6	P.10
C2LG6	P.11
C2YL6	J.59
C300X100A0T	O.21
C300X100APT	O.21
C300X100YJT	P.15
C315X030FJC	O.4
C315X030FJJ	O.22
C315X030YPT	O.15
C379X030A0T	O.21
C379X030APT	O.21
C379X030FJC	O.4
C379X030FJJ	O.22
C379X030Y0T-P	O.15
C379X030Y8T-P	O.15
C379X030Y9T-P	O.15
C379X030YPT	O.15
C379X030YPT-P	O.15
C379X030YQT-P	O.15
C379X030YRT-P	O.15
C379X030YST-P	O.15
C379X030YTT-P	O.15
C379X030YUT-P	O.15
C379X030YVT-P	O.15
C379X030YWT-P	O.15
C390X030Y1C	O.4
C390X030Y1J	O.22
C390X030Y1T	O.15
C3BL6	P.10
C3LG6	P.11
C400X100A0T	O.21
C400X100APT	O.21

Index by Part Number

Part Number	Page Number
C400X100AST	O.13
C400X100YJT	P.15
C400X200YJT	P.15
C400X400A11	O.28
C400X400A21	O.28
C400X400A31	O.28
C400X400A51	O.28
C400X400YZ1	O.28
C400X600A51	O.28
C400X600YX1	O.28
C400X600YZ1	O.28
C4BL6	P.10
C4LG6	P.11
C4PPLK	B.69, B.71, C.59, G.19
C4YL6	J.59
C6LG6	P.11
C6PPLK1-24	B.70
C6PPLK25-48	B.70
C750X050Y1C	O.4
C750X050Y1J	O.22
C750X050Y1T	O.15
C788X050Y1C	O.4
C788X050Y1J	O.22
C788X050Y1T	O.15
CADIN11G	G.21, N.4
CBEIWIY	G.14
CBEIWIY-2GY	G.14
CBIWI	G.14
CBIWI-2G	G.14
CBM-X	G.27
CBOT24K	P.23
CBR1.5I-M	P.26
CBR1.5M-M	P.26
CBR1M-M	P.26
CBR2HS-D	P.26
CBR2M-M	P.26
CBR2S-M	P.26
CBR3I-M	P.26
CBR3S-M	P.26
CBR4I-M	P.26
CBR4LH-TL	P.26
CBR4S-M	P.26
CBR6LH-C	P.26
CBTA1BL-X	G.21
CBTA1WH-X	G.21
CBTAL1BL-X	G.21
CBTAL1WH-X	G.21
CBX12IW-AY	G.23
CBX1IW-A	G.23
CBX2IW-AY	G.23
CBX4IW-AY	G.23
CBXC4IW-A	G.23
CBXD6IW-AY	G.23
CBXF12IW-AY	G.25
CBXF6BL-AY	N.4
CBXF6IW-AY	G.25
CBXJ2IW-A	G.23
CBXS1IW-A	G.24

Part Number	Page Number
CBXS2IW-A	G.24
CBXS3IW-AY	G.24
CBXS4IW-AY	G.24
CBXS6IW-AY	G.24
CBXSD6IW-AY	G.24
CC6X88IW	B.23
CC5E88IW	B.44
CC688IW	B.32
CCH100-S10-C	P.44
CCH112-S10-C	P.44
CCH119-S10-C	P.44
CCH125-S10-C	P.44
CCH12-S10-C	P.44
CCH138-S10-C	P.44
CCH150-S10-C	P.44
CCH19-S10-C	P.44
CCH25-S10-C	P.44
CCH31-S10-C	P.44
CCH38-S10-C	P.44
CCH44-S10-C	P.44
CCH50-S10-C	P.44
CCH56-S10-C	P.44
CCH62-S10-C	P.44
CCH69-S10-C	P.44
CCH75-S10-C	P.44
CCH81-S10-C	P.44
CCH87-S10-C	P.44
CCL	L.15
CCMKIT1	L.60
CCMKIT2	L.60
CCS12-S8-C	P.38
CCS19-S8-C	P.38
CCS25-S10-C	P.38
CCS25-S8-C	P.38
CCS31-S8-C	P.38
CCS38-S8-C	P.38
CCS44-S8-C	P.38
CCS50-S8-C	P.38
CD-920-1	M.49
CD-920-1/0	M.49
CD-920-2	M.49
CD-920-2/0	M.49
CD-920-250	M.49
CD-920-3/0	M.49
CD-920-350	M.49
CD-920-4	M.49
CD-920-4/0	M.49
CD-920-400	M.49
CD-920-500	M.49
CD-920-500A	M.49
CD-920-6	M.49
CD-920-600	M.49
CD-920-750	M.49
CD-920-8	M.49
CD-920H-2	M.49
CD-920H-6	M.49
CD-930H-250	M.49
CD-WGCD-1	J.73

Part Number	Page Number
CDE1	L.25
CDE2	L.25
CDM-920-2	M.49
CDM-920-3/0	M.49
CDM-920-4/0	M.49
CDpp8RG	N.4
CF1062IWY	G.17
CF1064IWY	G.17
CF10IW-X	K.19
CF3IW-E	K.19
CF5IW-E	K.19
CFAPPBL1	C.56
CFAPPBL1A	C.56
CFAPPBL2	C.56
CFAPPBL2A	C.56
CFFP4BL	G.19
CFFPA2BL	G.19
CFFPE3BL	G.19
CFFPEBSL4BL	G.19
CFFPHM4BL	G.19
CFFPKE3BL	G.19
CFFPL4BL	G.19
CFFPLA4BL	G.19
CFFPR1BL-X	G.20
CFG1IW	G.16
CFG2IW	G.16
CFG4IW	G.16
CFG6IW	G.16
CFKE2A5U3A	G.8
CFKE2A5U5J	G.8
CFKE2A6U3A	G.8
CFKE2A6U6J	G.8
CFKE2F5U3F	G.8
CFKE2F5U5J	G.8
CFKE2F6U3F	G.8
CFKE2F6U6J	G.8
CFKE4A5U5J3AMA	G.8
CFKE4A6U6J5AMA	G.8
CFKE4F5U5J3FMF	G.8
CFKE4F6U6J5FMF	G.8
CFP10S-2GY	G.13
CFP1IW	G.5
CFP2IW	G.5
CFP2SY	G.13
CFP4IW	G.5
CFP4S-2GY	G.13
CFP4SY	G.13
CFP6SY	G.13
CFP8S-2GY	G.13
CFPE1IWY	G.7
CFPE10IW-2GY	G.7
CFPE2IWY	G.7
CFPE4IWY	G.7
CFPE6IWY	G.7
CFFP12IW-2G	G.5
CFPH2IW	G.5
CFPH4IW	G.5
CFPHSL4IW	G.4

Index by Part Number

Part Number	Page Number
CFPL10S-2GY	G.12
CFPL2IWY	G.3
CFPL3IWY	G.3
CFPL4IWY	G.3
CFPL6IWY	G.3
CFPL2SY	G.12
CFPL4S-2GY	G.12
CFPL4SY	G.12
CFPL6S-2GY	G.12
CFPL6SY	G.12
CFPL8S-2GY	G.12
CFPS4IW	G.5
CFPSE4IWY	G.7
CFPSL2IWY	G.4
CFPSL4IWY	G.4
CFPSL6IWY	G.4
CFPTR2BEI	G.10
CFPTR4IW	G.10
CFPWR4CIG	G.11
CFS2IW	G.16
CFX10IW-X	K.20
CFX3IW-X	K.20
CFX5IW-X	K.20
CGJT	B.97
CGJ620U	M.18
CGJ620UB	M.18
CGJ630U	M.18
CGJ630UB	M.18
CGJ640U	M.18
CGJ640UB	M.18
CGNBSK	M.26
CGR630U	M.27
CGR630UB	M.27
CHB2IW-X	G.15
CHB2MIW-X	G.15
CHD15HDCIWY	B.60
CHD15HDCIWY	B.60
CHD9CIWY	B.60
CHF2IW-X	G.15
CHF2MIW-X	G.15
CHLS2SIW-X	G.15
CHR3RGIW	B.61
CHR3WYRIW	B.61
CHS1SIW-X	G.15
CHS2IW-X	G.15
CHS2SIW-X	G.15
CHSRE2IW-X	G.15
CICZC2X2	E.4
CICZC2X2A	E.4
CICZCBRKT	E.4
CIDIW-C	G.28
CIPIW-C	G.28
CJ5E88TGIW	B.40
CJ64IWY	B.57
CJ66IWY	B.57
CJ66UIWY	B.57
CJ688TGIW	B.28
CJ6X88TGIW	B.20

Part Number	Page Number
CJ88IWY	B.57
CJAST	B.97
CJASTB	B.97
CJE5E88TGIW	B.42
CJE688TGIW	B.29
CJK5E88TGBL	B.40
CJK688TGBL	B.28
CJK6X88TGBL	B.20
CJRRIW	B.62
CJRWIW	B.62
CJRYIW	B.62
CJS5E88TGY	B.48
CJS5E88TGY-24	B.35
CJS688TGY	B.36
CJS6X88TGY	B.16
CJSK5E88TGBL	B.48
CJSK688TGBL	B.36
CJSGK-XY	M.23
CJSVIW	B.61
CJT-X	B.97
CLRCVR1-1	M.42
CLRCVR2-1	M.42
CLRCVR3-1	M.42
CLT100F-C20	P.51
CLT100F-C3	P.51
CLT125F-L20	P.51
CLT125F-L3	P.51
CLT150F-T20	P.51
CLT150F-X20	P.51
CLT150F-X3	L.34, J.48, P.51
CLT150F-X4	P.51
CLT188F-X20	P.51
CLT188F-X3	P.51
CLT188F-X4	P.51
CLT25F-C20	P.51
CLT25F-C3	P.51
CLT38F-C20	P.51
CLT38F-C3	P.51
CLT50F-C20	P.51
CLT50F-C3	P.51
CLT75F-C20	P.51
CLT75F-C3	P.51
CLTS100F-C	P.51
CLTS100F-C3	P.51
CLTS125F-L	P.51
CLTS125F-L3	P.51
CLTS150F-D3	P.51
CLTS25F-C	P.51
CLTS25F-C3	P.51
CLTS38F-C	P.51
CLTS38F-C3	P.51
CLTS50F-C	P.51
CLTS50F-C3	P.51
CLTS75F-C	P.51
CLTS75F-C3	P.51
CM35MSCIWY	B.63
CM35MSSIW	B.63
CM6PIW	G.26

Part Number	Page Number
CMAA1IW-X	G.21
CMBA75IWY	B.64
CMBAIWY	B.64
CMBIW-X	B.58
CMBBL-X	C.36
CMBPBIWY	B.63
CMBPRIWY	B.63
CMBRC1	L.84
CMBRC5	L.84
CMBRC1E	L.84
CMBRC5E	L.84
CMBRS485OR	B.84
CMCSRIW	C.36
CMD15HDIWY	B.59
CMDABLLCZIW	C.34
CMDAGSCZBL	C.35
CMDAQSCBL	C.35
CMDAQSCZBL	C.35
CMDBIW-X	B.59
CMDBLSCBL	C.35
CMDBRDL CZIW	C.34
CMDBUSCZBU	C.35
CMDCGRLLCZIW	C.34
CMDDYLLCZIW	C.34
CMDEISCEI	C.35
CMDEORLCZIW	C.34
CMDFDBLCZIW	C.34
CMDJQLCBL	C.33
CMDJQLCZBL	C.33
CMDJBLLCBL	C.33
CMDJLCEI	C.33
CMDJLCZBU	C.33
CMDSAQLCBL	C.32, N.4
CMDSAQLCZBL	C.32
CMDSBLLCBL	C.32
CMDSLCEI	C.32
CMDSL CZBU	C.32
CMFIW	B.58
CMFSRIWY	B.59
CMHDMIW	B.64
CMLT19	L.82
CMMPOBLBL	C.31
CMNZABL-X	G.21
CMPH1	L.81
CMPH1C	L.81
CMPH2	L.81
CMPH2C	L.81
CMPHF1	L.81
CMPHF2	L.81
CMPHH2	L.81
CMPHH1	L.81
CMRPBIW	B.62
CMRPGIW	B.62
CMRPRIW	B.62
CMRPSH15	L.35
CMRPSH15S	L.35
CMRPSH20	L.35
CMRPSH20S	L.35

Index by Part Number

Part Number	Page Number
CMRPSH20SMTL	L.35
CMRPSH20STL	L.35
CMRPSV15SIL	L.35
CMRPSV15SILM	L.35
CMRPSV20	L.37
CMRPSV20C139	L.37
CMRPSV20C139TL	L.37
CMRPSV20S	L.37
CMRPSV20SIL	L.37
CMRPSV20SILM	L.37
CMRPSV20SILTL	L.37
CMRPSV20SILTLM	L.37
CMRPSV20SM	L.37
CMRPSV20STL	L.37
CMRPSV20STLM	L.37
CMRPSVD20	L.37
CMRPWIW	B.62
CMRPYIW	B.62
CMSAGSCZBL	C.35
CMSAQSCBL	C.35
CMSAQSCZBL	C.35
CMSBLSCBL	C.35
CMSBUSCZBU	C.35
CMSEISCEI	C.35
CMSTEI	C.36
CMSTZBU	C.36
CMSVCIWY	B.62
CMT4	L.82
CMUSBAAIW	B.64
CMUT19	L.82
CMVDR1	L.82
CMVDR1S	L.82
CMVDR2	L.82
CMVDR2S	L.82
CMVDRC	L.82
CMW2B	L.99
CMWB	L.98
CMW-KIT	L.98
CMWW	L.98
CN1	L.12
CN1CN	L.12
CN1CNNU	L.12
CN1CNU	L.14
CN1NU	L.12
CN2	L.12
CN2C	L.13
CN2CN	L.13
CN2CNU	L.13
CN2NU	L.13
CN2CNNU	L.13
CN3	L.13
CN3C	L.13
CN3CN	L.13
CN3CNNU	L.13
CN3CNU	L.13
CN4	L.13
CN4C	L.14
CN5	L.14

Part Number	Page Number
CN5C	L.14
CN12CNNU	L.14
CN12NU	L.14
CN182CNNU	L.17
CN18NU	L.17
CN22CNNU	L.14
CN22NU	L.14
CN28	L.17
CN28BCNNU	L.17
CN28BLCNNU	L.18
CN28BLNU	L.18
CN28BNU	L.17
CN28CNNU	L.17
CN28CNU	L.17
CN28HBCNNU	L.18
CN28HBNU	L.18
CN28NU	L.17
CN282BCNNU	L.18
CN348	L.17
CN3847018NU	L.16
CN42NU	L.14
CN4847018NU	L.16
CN48470182NU	L.16
CN484C7018NU	L.16
CN484C70182CNNU	L.16
CN5847018CNNU	L.16
CN5847018NU	L.16
CN584H7018	L.16
CN7018-EXT	L.7
CNAE1	L.25
CNAE2	L.25
CNAE3	L.25
CNAE7018	L.7
CNB4K	M.25
CNBK	M.25
CNBRFK	L.15
CNCSTR	L.15, L.22
CNDSH	L.22
CNFBB	L.15
CNFBB4R	L.15
CNFBBS	L.15
CNLTD142A3	L.25
CNLTD21B2	L.25
CNLTD52A2	L.25
CNLTD72A3	L.25
CNPP	L.15
CNPS	L.15
CNPS7018	L.7
CNPSPT	L.15
CNSPC	L.7
CNSPCA	L.15
CNSPE	L.15, L.62
CNVBP	L.15
CNVBP2	L.15
CNWS1224-C	L.15, L.62
CNWSM5-C	L.62
CNWSM6-C	L.62
CP106IW	K.23

Part Number	Page Number
CP106IW-2G	K.23
CP24BLY	B.73
CP24WSBLY	B.73
CP245E88BLY	B.45
CP24688BL	B.33
CP246X88BL	B.24
CP48BLY	B.73
CP48BNCBLY	B.65
CP48WSBLY	B.73
CP72BLY	B.73
CPA24BLY	B.73
CPA48BLY	B.73
CPA72BLY	B.73
CPAF1BLY	L.86
CPAF2BLY	L.86
CPATCBL	L.86
CPGIW	K.23
CPGIW-2G	K.23
CPP12WBL	B.72
CPP24FMWBLY	B.67
CPP24WBLY	B.69
CPP48FMWBLY	B.67
CPP48HDEWBL	B.68
CPP48HDVNSWBL	B.68
CPP48HDWBLY	B.68
CPP48WBLY	B.69
CPP72FMWBLY	B.68
CPPA24FMWBLY	B.67
CPPA48FMWBLY	B.67
CPPA48HDEWBL	B.68
CPPA48HDVNSWBL	B.68
CPPA48HDWBLY	B.68
CPPA72FMWBLY	B.68
CPPK6G24WBL	B.30
CPPKA6G24WBL	B.30
CPPKL6G24WBL	B.30
CPPKLA6G24WBL	B.30
CPPL24M6BLY	B.70
CPPL24WBLY	B.69, C.59
CPPL24WRBLY	B.71
CPPL48M6BLY	B.70
CPPL48WBLY	B.69, C.59
CPPL48WRBLY	B.71
CPPLA24WBLY	B.69, C.59
CPPLA48WBLY	B.69, C.59
CQ5108CS1B	L.3
CQ5108S652B	L.3
CQ5108S752B	L.3
CQ6509CN1B	L.5
CQ6509CN1C4	L.5
CQ6509CN1C6	L.5
CQ6509CN1F4	L.5
CQ7009CN01	L.6
CQ7009CN02	L.6
CQ7009CN03	L.6
CQ7009CN04	L.6
CQ7010CN1B	L.4
CQ7010CN1C4	L.4

Index by Part Number

Part Number	Page Number
CQ7010CN1C6	L.4
CQ7010CN1F4	L.4
CRB6BL	L.26
CRB6ECBL	L.26
CRB6VEDBL	L.26
CRBRDGBL	L.26
CRFC5IW-X	K.19, K.20
CRFPA2BL	G.20
CRS1-125-X	L.54
CRS1-X	L.54
CRS4-125-X	L.54
CRS6-X	L.54
CRTB	L.26
CRTW	L.28
CRVEDTB	L.26
CS1	L.20
CS1NU	L.20
CS1RNU	L.20
CS2	L.20
CS2NU	L.20
CS3	L.20
CS3NU	L.21
CS348	L.22
CS348NU	L.22
CS4RNU	L.21
CS5	L.21
CS12NU	L.21
CS182NU	L.22
CS18HNU	L.22
CS22NU	L.21
CS28	L.21
CS282NU	L.22
CS28HNU	L.22
CS28LNU	L.21
CS28NU	L.21
CSBA	L.15
CSBM-X	G.27
CSC1LG6	P.14
CSCIW-X	G.28
CSGLLC-L	G.29
CSM-1.25-C	L.94
CSPC1.5LG-Q	P.11
CSPC1LG-Q	P.11
CSPC2LG-Q	P.11
CSPC3LG-Q	P.11
CSPC4LG-Q	P.11
CSRCE	L.22
CST115	C.101, C.103
CT-100A	M.46
CT-1550	M.46
CT-1570	M.46
CT-1700	M.46
CT-1701	M.46
CT-2930/L	M.48
CT-2930/LE	M.48
CT-930	M.47
CTAPF1/0-12	M.56, M.57
CTAPF1/0-12TP-L	M.43

Part Number	Page Number
CTAPF2/0-12TP-Q	M.43
CTAPF2/0-12	M.56, M.57
CTAPF4-12	M.56, M.57
CTAPF4-12TP-C	M.43
CTCC3X8	L.34
CTG3X8	L.34
CTIDT15	L.34
CTRW	L.34
CUFB48BL	E.6
CUFF-KIT	E.6
CUFMB24BL	E.6
CVED32	L.15
CVED32V	L.9
CVED32VE	L.18
CVED32VES	L.18
CVED40VE	L.16
CVED40VEN	L.16
CVPDUB	L.22, L.62
CVPDUB48	L.18
CVPPB	L.22, L.62
CWF400	L.98
CWMPV2340	L.86
CWMPV2440	L.86
CWMPV3340	L.86
CWMPV3440	L.86
CWPP12WBL	B.72
CWST	B.97
CXCAC08F04IRBL	L.24
CXCAC08F06IRBL	L.24

D

D2H6	P.13
D2HWH6	P.13
D3H6	P.13
D3HWH6	P.13
D4H6	P.13
D4HWH6	P.13
DCEFXIW-X	K.20
DCF10IW-X	K.19
DCF3IW-X	K.19
DCF5IW-X	K.19
DCT	P.15
DNT-100	P.15
DP125E88TGY	B.43
DP12688TGY	B.31
DP245E88TGY	B.43
DP245E88TV25	B.54
DP24584TV25Y	B.53
DP24688TGY	B.31
DP246X88TGY	B.22
DP485E88TGY	B.43
DP485E88TV25	B.54
DP48584TV25Y	B.53
DP48688TGY	B.31
DP486X88TGY	B.22
DPA245E88TGY	B.43
DPA245E88TV25	B.54
DPA24688TGY	B.31

Part Number	Page Number
DPA246X88TGY	B.22
DPA485E88TGY	B.43
DPA485E88TV25	B.54
DPA48688TGY	B.31
DPA486X88TGY	B.22
DPFP1	L.85
DPFP2	L.85
DPFP4	L.85
DPFP8	L.85
DPFPAI	L.85
DPOE24U1XG	D.3
DPOE8KIT	D.4
DPOE8S2XG	D.4
DPOEPL8BU	D.4
DPOEPWRB120Y	D.5
DPOEPWRB120Y-J	D.5
DPOEPWRCU	D.5
DPOEPWRR1250	D.5
DPOESHelf	D.4
DPOEWM8B	D.4
DT14EH-L0	P.33
DT15EH-L0	P.33
DT28EH-C0	P.33
DT44EH-C0	P.33
DT4EH-L0	P.33
DT8EH-Q0	P.33
DTHEH-Q0	P.33
DTHH-Q0	P.33
DTKEH-0	P.33
DTKH-0	P.33
DTREH-LR0	P.33
DTRH-LR0	P.33

E

E2X2YL6	J.59
E4X4YL6	J.59
ECF10IW-X	K.19
ECF3IW-E	K.19
ECF5IW-E	K.19
ECFX10IW-X	K.20
ECFX3IW-X	K.20
ECFX5IW-X	K.20
EFPK102G-XY	G.29
EFPK-XY	G.29
EGJT	B.97
ERT2M-C20	P.25
ERT3M-C20	P.25
ERT4.5M-C20	P.25

F

F100X150AJC	O.6
F100X150AJT	O.20
F100X213AJT	O.20
F100X300AJT	O.20
F100X363AJT	O.20
F14PN-L	J.62
F14PWN-L	J.62
F1ASZN-9612-10F	C.46

Index by Part Number

Part Number	Page Number
F1ASZN-9612-10S	C.46
F1RBZN-9608-10F	C.46
F1RBZN-9608-10S	C.46
F1RCZN-9612-10F	C.46
F1RCZN-9612-10S	C.46
F1RSZN-9612-10	C.46
F1RSXN-9612-10	C.46
F1RSXO-9612-10	C.46
F1RSZO-9612-10	C.46
F1AS9N-1A12-10F	C.46
F1AS9N-1A12-10S	C.46
F250BT-C	C.27
F2PCLB12	J.9, J.22, J.35, J.64
F2PCLB58	J.22, J.35, J.64
F512D5-5M1Y	C.93
F612D3-5M1Y	C.94
F64D5-5M1Y	C.94
F66D5-5M1Y	C.94
F68D5-5M1Y	C.94
F6B10-NM1Y	C.65
F6B10A-NM1	C.75
F6B10B-NM1	C.75
F6B10C-NM1	C.75
F6B10D-NM1	C.75
F6B10E-NM1	C.75
F6B10F-NM1	C.75
F6B3-NM1Y	C.65
F6B6J-NM1Y	C.66
F6D2-2M1Y	C.65
F6D2-3M1Y	C.66
F6D3-3M1Y	C.65
F6D6J-NM1Y	C.65
F6D6P-2M1Y	C.66
F6D6P-3M1Y	C.66
F6D6P-6PM1Y	C.65
F6D6PW-3M1Y	C.77
F6D6PX-3M1Y	C.77
F6D6PY-3M1Y	C.77
F6D6PZ-3M1Y	C.77
F6E10-10M1Y	C.65
F6E10A-10AM1	C.75
F6E10A-10M1	C.76
F6E10B-10BM1	C.75
F6E10B-10M1	C.76
F6E10C-10CM1	C.75
F6E10C-10M1	C.76
F6E10D-10DM1	C.75
F6E10D-10M1	C.76
F6E10E-10EM1	C.75
F6E10E-10M1	C.76
F6E10F-10FM1	C.75
F6E10F-10M1	C.76
F6E3-10AM1	C.77
F6E3-10BM1	C.77
F6E3-10CM1	C.77
F6E3-10DM1	C.77
F6E3-10EM1	C.77
F6E3-10FM1	C.77

Part Number	Page Number
F6E3-10M1Y	C.66
F6E6P-10M1Y	C.66
F6F10-10M1Y	C.65
F6PE10A-NM1	C.76
F6PE10B-NM1	C.76
F6PE10C-NM1	C.76
F6PE10D-NM1	C.76
F6PE10E-NM1	C.76
F6PE10F-NM1	C.76
F6S2-2M1Y	C.65
F6S3-3M1Y	C.65
F6Z12-12M1	C.66
F6Z2-12M1	C.66
F6Z3-12M1	C.66
F6Z6P-12M1	C.66
F912D5-5M1Y	C.95
F94D5-5M1Y	C.95
F96D5-5M1Y	C.95
F98D5-5M1Y	C.95
F9B10-NM1Y	C.68
F9B10A-NM1	C.79
F9B10B-NM1	C.79
F9B10C-NM1	C.79
F9B10D-NM1	C.79
F9B10E-NM1	C.79
F9B10F-NM1	C.79
F9B2-NM1Y	C.68
F9B3-NM1Y	C.68
F9B3A-3AM1	C.71
F9B3A-NM1	C.71
F9B6J-NM1Y	C.69
F9D2-2M1Y	C.68
F9D2-3M1Y	C.69
F9D3-3M1Y	C.68
F9D6J-NM1Y	C.68
F9D6P-3M1Y	C.69
F9D6P-6PM1Y	C.68
F9E10-10M1Y	C.68
F9E10A-10AM1	C.79
F9E10A-10M1	C.80
F9E10B-10BM1	C.79
F9E10B-10M1	C.80
F9E10C-10CM1	C.79
F9E10C-10M1	C.80
F9E10D-10DM1	C.79
F9E10D-10M1	C.80
F9E10E-10EM1	C.79
F9E10E-10M1	C.80
F9E10F-10FM1	C.79
F9E10F-10M1	C.80
F9E3-10AM1	C.80
F9E3-10BM1	C.80
F9E3-10CM1	C.80
F9E3-10DM1	C.80
F9E3-10EM1	C.80
F9E3-10FM1	C.80
F9E3-10M1Y	C.69
F9E6P-10M1Y	C.69

Part Number	Page Number
F9F10-10M1Y	C.68
F9F3-10M1Y	C.69
F9F3A-3AM1	C.71
F9F3A-NM1	C.71
F9N0505RTPM001	C.96
F9PE10A-NM1	C.79
F9PE10B-NM1	C.79
F9PE10C-NM1	C.80
F9PE10D-NM1	C.80
F9PE10E-NM1	C.80
F9PE10F-NM1	C.80
F9S2-2M1Y	C.68
F9S2-3M1Y	C.69
F9S3-3M1Y	C.68
F9S3A-3AM1	C.71
F9S3A-NM1	C.71
FADC4X4	J.36
FADJLCAQ-L	C.29
FADJLCBL-L	C.29
FADJLCEI-L	C.29
FADJLCZAQ-L	C.29
FADJLCZBU-L	C.29
FADSCAQ-L	C.30
FADSCBL-L	C.30
FADSCBU-L	C.30
FADSCBI-L	C.30
FADSCZAG-L	C.30
FADSCZAQ-L	C.30
FADSCZBU-L	C.30
FADSLCAQ-L	C.28
FADSLCBL-L	C.28
FADSLCEI-L	C.28
FADSLCZAQ-L	C.28
FADSLCZBU-L	C.28
FALC	C.101, C.103
FAP12WABLDLCZ	C.40
FAP12WAGSCZ	C.42
FAP12WAQDLCZ	C.39
FAP12WAQLCZ	C.39
FAP12WBLDLC	C.39
FAP12WBLSLSC	C.41
FAP12WBRDDLCZ	C.40
FAP12WBUDLCZ	C.39
FAP12WBULCZ	C.39
FAP12WBUSCZ	C.42
FAP12WCGRDLCZ	C.40
FAP12WDYLDLCZ	C.40
FAP12WEIDLC	C.39
FAP12WEISC	C.41
FAP12WEORDLCZ	C.40
FAP12WFDBDLCZ	C.40
FAP2WAGDSCZ	C.42
FAP2WAQDSC	C.41
FAP2WAQDSCZ	C.41
FAP2WBLDSC	C.41
FAP2WBUDSCZ	C.42
FAP2WEIDSC	C.41
FAP3WAGDSCZ	C.42

Index by Part Number

Part Number	Page Number
FAP3WAQDSC	C.41
FAP3WAQDSCZ	C.41
FAP3WBLDSC	C.41
FAP3WBUDSCZ	C.42
FAP3WEIDSC	C.41
FAP4WAGDSCZ	C.42
FAP4WAQDSC	C.41
FAP4WAQDSCZ	C.41
FAP4WBLDSC	C.41
FAP4WBUDSCZ	C.42
FAP4WEIDSC	C.41
FAP6WABLDLCZ	C.40
FAP6WAGDSCZ	C.42
FAP6WAGSCZ	C.42
FAP6WAQDLC	C.39
FAP6WAQDLCZ	C.39
FAP6WAQDSC	C.41
FAP6WAQDSCZ	C.41
FAP6WAQSC	C.41
FAP6WAQSCZ	C.41
FAP6WBLDLC	C.39
FAP6WBLDSC	C.41
FAP6WBLS	C.41
FAP6WBRDDLDCZ	C.40
FAP6WBUDLCZ	C.39
FAP6WBUDSCZ	C.42
FAP6WBUSCZ	C.42
FAP6WCGRDLCZ	C.40
FAP6WDYLDLCZ	C.40
FAP6WEIDLC	C.39
FAP6WEIDSC	C.41
FAP6WEISC	C.41
FAP6WEORDLCZ	C.40
FAP6WFDBDLCZ	C.40
FAP6WST	C.43
FAP6WSTA	C.43
FAP6WSTZ	C.43
FAP8WABLDLCZ	C.40
FAP8WAQDLC	C.39
FAP8WAQDLCZ	C.39
FAP8WBLDLC	C.39
FAP8WBRDDLDCZ	C.40
FAP8WBUDLCZ	C.39
FAP8WCGRDLCZ	C.40
FAP8WDYLDLCZ	C.40
FAP8WEIDLC	C.39
FAP8WEORDLCZ	C.40
FAP8WFDBDLCZ	C.40
FAP8WST	C.43
FAP8WSTZ	C.43
FAPB	C.43
FAPH0412BLMPO	C.38
FAPH0612BLMPO	C.38
FAPH0812BLMPO	C.38
FAPH1212BLMPO	C.38
FAPH1612BLMPO	C.38
FAPH1812BLMPO	C.38
FAPV0412BLMPO	C.38

Part Number	Page Number
FAPV0612BLMPO	C.38
FAPV0812BLMPO	C.38
FASJLCZBU-L	C.29
FASSCAQ-L	C.30
FASSCBL-L	C.30
FASSCBU-L	C.30
FASSCEI-L	C.30
FASSCZAG-L	C.30
FASSCZAQ-L	C.30
FASSCZBU-L	C.30
FASSLCZBU-L	C.28
FASST-L	C.31
FASSTZ-L	C.31
FBA10IW-X	K.19
FBA5IW-X	K.19
FBC2X2YL	J.53
FBFSP	C.101, C.103
FC12SCMP5Y	C.53
FC12SCSP5Y	C.53
FC5-12-10ABL	C.51
FC5-12-10BRD	C.51
FC5-12-10CGR	C.51
FC5-12-10DYL	C.51
FC5-12-10EOR	C.51
FC5-12-10FDB	C.51
FC5-12-10Y	C.48
FC5-12-3SY	C.48
FC5-12-3Y	C.48
FC5-24-10ABL	C.51
FC5-24-10BRD	C.51
FC5-24-10CGR	C.51
FC5-24-10DYL	C.51
FC5-24-10EOR	C.51
FC5-24-10FDB	C.51
FC5-24-10Y	C.48
FC6-12-10ABL	C.52
FC6-12-10BRD	C.52
FC6-12-10CGR	C.52
FC6-12-10DYL	C.52
FC6-12-10EOR	C.52
FC6-12-10FDB	C.52
FC6-12-10Y	C.48
FC6-12-3SY	C.48
FC6-12-3Y	C.48
FC6-24-10ABL	C.52
FC6-24-10BRD	C.52
FC6-24-10CGR	C.52
FC6-24-10DYL	C.52
FC6-24-10EOR	C.52
FC6-24-10FDB	C.52
FC6-24-10Y	C.48
FC6-6-3	C.48
FC9-12-10ABL	C.53
FC9-12-10BRD	C.53
FC9-12-10CGR	C.53
FC9-12-10DYL	C.53
FC9-12-10EOR	C.53
FC9-12-10FDB	C.53

Part Number	Page Number
FC9-12-10Y	C.48
FC9-12-3SY	C.48
FC9-12-3Y	C.48
FC9-24-10ABL	C.53
FC9-24-10BRD	C.53
FC9-24-10CGR	C.53
FC9-24-10DYL	C.53
FC9-24-10EOR	C.53
FC9-24-10FDB	C.53
FC9-24-10Y	C.48
FC9-6-3	C.48
FCAMKIT	C.101
FCAMKITUPG	C.102
FCAMKITUPG-G	C.102
FCE1U	C.54
FCE1UA	C.54
FCE2U	C.54
FCE4U	C.54
FCF2X2YL	J.60
FCF4X4YL	J.60
FCLEANKIT	C.101, C.102
FCRP5	C.103
FCX-12-10ABL	C.50
FCX-12-10BRD	C.50
FCX-12-10CGR	C.50
FCX-12-10DYL	C.50
FCX-12-10EOR	C.50
FCX-12-10FDB	C.50
FCX-12-10BY	C.48
FCX-12-10Y	C.48
FCX-12-3SY	C.48
FCX-12-3Y	C.48
FCX-24-10ABL	C.50
FCX-24-10BRD	C.50
FCX-24-10CGR	C.50
FCX-24-10DYL	C.50
FCX-24-10EOR	C.50
FCX-24-10FDB	C.50
FCX-24-10BY	C.48
FCX-24-10Y	C.48
FCXO-12-10ABL	C.49
FCXO-12-10BRD	C.49
FCXO-12-10CGR	C.49
FCXO-12-10DYL	C.49
FCXO-12-10EOR	C.49
FCXO-12-10FDB	C.49
FCXO-12-10BY	C.47
FCXO-12-10Y	C.47
FCXO-12-3Y	C.47
FCXO-24-10ABL	C.49
FCXO-24-10BRD	C.49
FCXO-24-10CGR	C.49
FCXO-24-10DYL	C.49
FCXO-24-10EOR	C.50
FCXO-24-10FDB	C.50
FCXO-24-10BY	C.47
FCXO-24-10Y	C.47
FCZ-12-10BY	C.48

Index by Part Number

Part Number	Page Number
FCZ-12-10Y	C.48
FCZ-12-3Y	C.48
FCZ-24-10BY	C.48
FCZ-24-10Y	C.48
FCZO-12-10BY	C.47
FCZO-12-10Y	C.47
FCZO-24-10BY	C.47
FCZO-24-10Y	C.47
FCZO-12-3Y	C.47
FEABRU	C.57
FEABRUA	C.57
FEBRC	C.61
FEC2X2YL	J.60
FEC4X4YL	J.60
FELS	C.60
FELU	C.60
FFWC2X2YL	J.60
FFWC4X4YL	J.60
FGLS	C.101, C.103
FHDEC2X2YL	J.53
FHP5126LM005N	C.91
FHP5126LM010N	C.91
FHP5126LM015N	C.91
FHP5126LM020N	C.91
FHP9126LM005N	C.91
FHP9126LM010N	C.91
FHP9126LM015N	C.91
FHP9126LM020N	C.91
FHPX126LM005N	C.91
FHPX126LM010N	C.91
FHPX126LM015N	C.91
FHPX126LM020N	C.91
FHSCT	C.103
FHSCT-W	C.103
FIBCT	C.104
FIDT2X2YL	J.7, J.18, J.30, J.45, J.54, J.61
FIDT4X4BL	J.29, J.44, J.61
FIELDKIT	C.102
FIELDKIT-G	C.102
FIELDKITRFB	C.102
FIELDKITUPG	C.101
FITF6X4	J.32
FIV452X2YL	J.60
FIV454X4YL	J.60
FIVRA2X2YL	J.60
FIVRA4X4YL	J.60
FJPKGU	C.103
FJPMR	C.103
FJPHY	C.103
FJQCVR	C.101
FJQCVRB	C.101
FK2BJ	C.28
FK4BJ	C.28
FKITCASE	C.101, C.102, C.104
FKS	C.101, C.102, C.104
FL12X12LG-A	P.12
FL25X25LG-A	P.12

Part Number	Page Number
FL50X50LG-A	P.12
FLB	J.63
FLBSIM-Y	L.85
FLCASC	C.103
FLCBT2AQ-X	C.25
FLCBT3AQ-X	C.25
FLCBT900AQ-X	C.25
FLCC	C.101
FLCCLIP-L	C.25
FLCCLIPBL-L	C.19, C.21
FLCCLIW-X	C.82
FLCDM3.OBL	C.24
FLCDM3.OEI	C.24
FLCDM900BLY	C.24
FLCDM900EIY	C.24
FLCDMBLY	C.24
FLCDMC5BLY	C.19
FLCDMC6EIY	C.19
FLCDMCXAQY	C.19, N4
FLCDMEIY	C.24
FLCDS3.OBU	C.25
FLCDS900BUY	C.25
FLCDSBUY	C.25
FLCDSBUY	C.19
FLCDSBUY	C.103
FLCFPLF-X	C.103
FLCPAD	C.103
FLCPK	C.103
FLCSM3.OBL	C.24
FLCSM3.OEI	C.24
FLCSMBLY	C.24
FLCSMC5ABL	C.20
FLCSMC5BLY	C.19
FLCSMC5BRD	C.20
FLCSMC5CGR	C.20
FLCSMC5DYL	C.20
FLCSMC5EOR	C.20
FLCSMC5FDB	C.20
FLCSMC6ABL	C.21
FLCSMC6BRD	C.21
FLCSMC6CGR	C.21
FLCSMC6DYL	C.21
FLCSMC6EIY	C.19
FLCSMC6EOR	C.21
FLCSMC6FDB	C.21
FLCSMCXAABL	C.20
FLCSMCXAQY	C.19
FLCSMCXBRD	C.20
FLCSMCXCGR	C.20
FLCSMCXDYL	C.20
FLCSMCXEOR	C.20
FLCSMCXFDB	C.20
FLCSMEIY	C.24
FLCSS3.OBU	C.25
FLCSSBUY	C.25
FLCSSCABL	C.21
FLCSSCBRD	C.21
FLCSSCBUY	C.19
FLCSSCCGR	C.21

Part Number	Page Number
FLCSSCDYL	C.21
FLCSSCEOR	C.21
FLCSSCFDB	C.21
FLOUPEX10	C.103
FLPT	C.103
FLRB	J.63
FMCBT2AQ-X	C.19, C.22, C.23
FMCBT2BL-X	C.19, C.21, C.22, C.23
FMCBT2EI-X	C.19, C.22, C.23
FMCBT3AQ-X	C.19, C.22, C.23
FMCBT3BL-X	C.19, C.21, C.22, C.23
FMCBT3EI-X	C.19, C.22, C.23
FMFIN	C.61
FMP6	C.43
FMS1	C.61
FMS2	C.61
FMSS	C.61
FMT1	C.56
FMT1A	C.56
FMT2	C.56
FMT2A	C.56
FMTPFCT	C.104
FMTPMFCT	C.104
FMTPRR6	C.104
FO12CB	C.28
FO6CB	C.28
FOCPX06Y	C.9
FOCPX12Y	C.9
FOCPZ06Y	C.9
FOCPZ12Y	C.9
FOCRX06Y	C.8
FOCRX12Y	C.8
FOCRZ06Y	C.8
FOCRZ12Y	C.8
FODPX06Y	C.5
FODPX12Y	C.5
FODPX24Y	C.5
FODPX36Y	C.5
FODPZ06Y	C.5
FODPZ12Y	C.5
FODPZ24Y	C.5
FODPZ36Y	C.5
FODRX06Y	C.4
FODRX12Y	C.4
FODRX24Y	C.4
FODRX36Y	C.4
FODRZ06Y	C.4
FODRZ12Y	C.4
FODRZ24Y	C.4
FODRZ36Y	C.4
FOGPX06Y	C.12
FOGPX12Y	C.12
FOGPZ06Y	C.12
FOGPZ12Y	C.12
FOGRX06Y	C.11
FOGRX12Y	C.11
FOGRZ06Y	C.11
FOGRZ12Y	C.11

Index by Part Number

Part Number	Page Number
FOIPZ02Y	C.18
FOIRZ024	C.18
FOMPX24Y	C.12
FOMPX36Y	C.12
FOMPZ24Y	C.12
FOMPZ36Y	C.12
FOMRX24Y	C.11
FOMRX36Y	C.11
FOMRZ24Y	C.11
FOMRZ36Y	C.11
FONPX24Y	C.9
FONPX36Y	C.9
FONPZ24Y	C.9
FONPZ36Y	C.9
FONRX24Y	C.8
FONRX36Y	C.8
FONRZ24Y	C.8
FONRZ36Y	C.8
FOPPX06Y	C.7
FOPPX12Y	C.7
FOPPX24Y	C.7
FOPPX36Y	C.7
FOPPZ06Y	C.7
FOPPZ12Y	C.7
FOPPZ24Y	C.7
FOPPZ36Y	C.7
FOPRX06Y	C.6
FOPRX12Y	C.6
FOPRX24Y	C.6
FOPRX36Y	C.6
FOPRZ06Y	C.6
FOPRZ12Y	C.6
FOPRZ24Y	C.6
FOPRZ36Y	C.6
FOSMF	C.62
FOSMH1U	C.62
FOSMH2U	C.62
FOSMH4U	C.62
FOSMM	C.62
FOTNX06	C.14
FOTNX12	C.14
FOTNX24	C.14
FOTNX36	C.14
FOTNZ06	C.14
FOTNZ12	C.14
FOTNZ24	C.14
FOTNZ36	C.14
FOV452X2YL	J.60
FOV454X4YL	J.60
FOVRA2X2YL	J.60
FOVRA4X4YL	J.60
FOWNX06	C.16
FOWNX12	C.16
FOWNX24	C.16
FOWNX36	C.16
FOWNZ06	C.16
FOWNZ12	C.16
FOWNZ24	C.16

Part Number	Page Number
FOWNZ36	C.16
FPAD	C.103
FPF1-V	C.103
FPFPC1	C.46
FPP5-L	C.103
FPPKIT-CVY	C.101
FPWIRE	C.103
FQ5-12-10	C.45
FQ5-6-3	C.45
FQ6-12-10	C.45
FQ6-6-3	C.45
FQ9-12-10	C.45
FQ9-6-3	C.45
FQCBRUA	C.57
FQCRCM	C.47
FQMAP45BL	C.37
FQMAP65BL	C.37
FQMAP85BL	C.37
FQPX48VVM050N	C.45
FQX-12-10	C.44
FQX-12-10B	C.44
FQX-6-3	C.44
FQXO-12-10	C.44
FQXO-12-10B	C.44
FQXO-6-3	C.44
FQZ-12-10	C.44
FQZ-12-10B	C.44
FQZ-6-3	C.44
FQZO-12-10	C.44
FQZO-12-10B	C.44
FQZO-6-3	C.44
FR1.5IDEYL	J.19, J.31, J.46
FR12ACAB	J.21
FR12ACB12	J.20
FR12ACB12M	J.20
FR12ACB58	J.20
FR12ACB58M	J.20
FR12ALB	J.20
FR12BS-L	J.9, J.22
FR12CS12	J.20
FR12CS12M	J.20
FR12CS58	J.20
FR12CS58M	J.20
FR12TB12	J.20
FR12TB12M	J.20
FR12TB2412	J.21
FR12TB2412M	J.21
FR12TB2458	J.21
FR12TB2458M	J.21
FR12TB58	J.20
FR12TB58M	J.20
FR12TRBE58	J.20
FR12TRBE58M	J.20
FR12TRBN58	J.20
FR12TRBN58M	J.20
FR12USB	J.20
FR12X4YL6	J.12
FR16S1-R1KIT	C.84

Part Number	Page Number
FR16S1-R1M02	C.88
FR16S1-R2M02	C.88
FR16S1-R3M02	C.88
FR16S2-R1M02	C.88
FR16S2-R2KIT	C.84
FR16S2-R2M02	C.88
FR16S2-R3M02	C.88
FR16S3-R1M02	C.88
FR16S3-R2M02	C.88
FR16S3-R3M02	C.88
FR19S1-R1KIT	C.85
FR19S1-R1M02	C.89
FR19S1-R2M02	C.89
FR19S1-R3M02	C.89
FR19S2-R1M02	C.89
FR19S2-R2KIT	C.85
FR19S2-R2M02	C.89
FR19S2-R3M02	C.89
FR19S3-R1M02	C.89
FR19S3-R2M02	C.89
FR19S3-R3M02	C.89
FR1XS1-R1KIT	C.83
FR1XS1-R1M02	C.87
FR1XS1-R2M02	C.87
FR1XS1-R3M02	C.87
FR1XS2-R1M02	C.87
FR1XS2-R2KIT	C.83
FR1XS2-R2M02	C.87
FR1XS2-R3M02	C.87
FR1XS3-R1M02	C.87
FR1XS3-R2M02	C.87
FR1XS3-R3M02	C.87
FR2XS2-RLKIT	C.84
FR24X4TBN12	J.9
FR24V4TBN12M	J.9
FR24X4TBE12	J.9
FR24X4TBE12M	J.9
FR24X4YL10	J.4
FR26S2-R2M02	C.87
FR26S2-F2KIT	C.84
FR26S2-RLKIT	C.84
FR26S2-RLM02	C.87
FR26S2-RSKIT	C.84
FR26S2-RSM02	C.87
FR26SL-R2M02	C.87
FR26SL-RLM02	C.87
FR26SL-RSM02	C.87
FR26SS-R2KIT	C.84
FR26SS-R2M02	C.87
FR26SS-RLKIT	C.84
FR26SS-RLM02	C.87
FR26SS-RSKIT	C.84
FR26SS-RSM02	C.87
FR29S2-R2KIT	C.85
FR29S2-R2M02	C.88
FR29S2-RLM02	C.88
FR29S2-RSKIT	C.85
FR29S2-RSM02	C.88

Index by Part Number

Part Number	Page Number
FR29SL-R2M02	C.88
FR29SL-RLM02	C.88
FR29SL-RSM02	C.88
FR29SS-R2KIT	C.85
FR29SS-R2M02	C.88
FR29SS-RLKIT	C.85
FR29SS-RLM02	C.88
FR29SS-RSKIT	C.85
FR29SS-RSM02	C.88
FR29S2-RLKIT	C.85
FR2XS2-R2KIT	C.83
FR2XS2-R2M02	C.86
FR2XS2-RLM02	C.86
FR2XS2-RSKIT	C.83
FR2XS2-RSM02	C.86
FR2XSL-R2M02	C.86
FR2XSL-RLM02	C.86
FR2XSL-RSM02	C.86
FR2XSS-R2KIT	C.84
FR2XSS-R2M02	C.86
FR2XSS-RLKIT	C.83
FR2XSS-RLM02	C.86
FR2XSS-RSKIT	C.83
FR2XSS-RSM02	C.86
FR38DR	J.47
FR4PRB58	J.21, J.35
FR4X4YL6	J.40
FR516DR	J.47
FR6ACAB	J.35
FR6ACB12	J.34
FR6ACB12M	J.34
FR6ACB58	J.34
FR6ACB58M	J.34
FR6ALB	J.33
FR6CS12	J.33
FR6CS12M	J.33
FR6CS58	J.33
FR6CS58M	J.33
FR6LB	J.35
FR6LRB	J.35
FR6TB12	J.34
FR6TB12M	J.34
FR6TB38	J.34
FR6TB38M	J.34
FR6TRBE12	J.33
FR6TRBE12M	J.33
FR6TRBE58	J.33
FR6TRBE58M	J.33
FR6TRBN12	J.33
FR6TRBN12M	J.33
FR6TRBN58	J.33
FR6TRBN58M	J.33
FR6USB	J.33
FR6X4YL6	J.25
FR716DR	J.47, J.73
FRA2X2YL	J.60
FRA4X4YL	J.60
FRADC12X4BL	J.36

Part Number	Page Number
FRADC4X4BL	J.36
FRADC6X4YL	J.36
FRAFCS8	J.9, J.22, J.35, J.64
FRBC12X4YL	J.13
FRBC24X4YL	J.4
FRBC4X4YL	J.41
FRBC6X4YL	J.26
FRCR12BL-X	J.12
FRCR4BL-X	J.40
FRCR6BL-X	J.25
FRCV24YL10	J.4
FRDDS6X4YL	J.31
FRDDSHC6YL	J.31
FREC12X4YL	J.15
FREC24X4YL	J.5
FREC4X4YL	J.42
FREC6X4YL	J.27
FRF42YL	J.60
FRFWC12X4W4YL	J.15
FRFWC12X4W6YL	J.14
FRFWC12X4YL	J.14
FRFWC24X4W12YL	J.5
FRFWC4X4YL	J.42
FRFWC6X4YL	J.27
FRFWCCV24W12YL	J.5
FRFWCCV24YL	J.5
FRFWCSC12W4YL	J.15
FRFWCSC12W6YL	J.15
FRFWCSC12YL	J.14
FRFWC24X4YL	J.5
FRFWCSC4YL	J.42
FRFWCSC6YL	J.27
FRH4512X4YL	J.13
FRH452X4YL	J.5
FRH4524X4YL	J.5
FRH454X4YL	J.41
FRH456X4YL	J.26
FRH45CV24YL	J.5
FRH45SC12YL	J.13
FRH45SC4YL	J.41
FRH45SC6YL	J.26
FRHC12YL6	J.12
FRHC4YL6	J.40
FRHC6YL6	J.25
FRHD2KTYL	J.7, J.18, J.30, J.45, J.54
FRHD4KTYL	J.8, J.17, J.29, J.44
FRIDT4X4YL	J.8, J.19, J.31, J.46
FRIDT6X4YL	J.17, J.32
FRIV4512X4YL	J.15
FRIV4524X4YL	J.6
FRIV454X4YL	J.42
FRIV456X4YL	J.27
FRIVRA4X4YL	J.42
FRIVRA6X4YL	J.27
FRLPR42BL	J.28, J.44
FRLPR64BL	J.17
FRME1U	C.55
FRME2U	C.55

Part Number	Page Number
FRME3	C.55
FRME4	C.55
FRNWT12	J.37
FRNWT128	J.37
FROV4512X4YL	J.15
FROV4524X4YL	J.6
FROV454X4YL	J.42
FROV456X4YL	J.27
FROV45CV24YL	J.6
FROV45SC12YL	J.15
FROV45SC4YL	J.43
FROV45SC6YL	J.27
FROVRA12X4YL	J.15
FROVRA4X4YL	J.43
FROVRA6X4YL	J.28
FROVRASC12YL	J.15
FROVRASC4YL	J.43
FROVRASC6YL	J.28
FRQMC-X	J.48
FRQMC24-X	J.9
FRRRA12X4YL	J.13
FRRRA4X4YL	J.41
FRRRA6X4YL	J.26
FRRASC12YL	J.13
FRRASC4YL	J.41
FRRASC6YL	J.26
FRRF126LSCYL	J.16
FRRF126LYL	J.16
FRRF126RSCYL	J.16
FRRF126RYL	J.16
FRRF126SCYL	J.16
FRRF126YL	J.16
FRRF2412YL	J.6
FRRF2412CVYL	J.6
FRRF4FD2YL	J.43
FRRF4FD4YL	J.43
FRRF64YL	J.28
FRRF6FR4SCYL	J.28, J.43
FRRF6FR4YL	J.28, J.43
FRRMBNF58	J.35
FRSHC4YL6	J.40
FRSHC6YL6	J.25
FRSPJ2X2YL	J.7, J.17, J.29, J.45
FRSPJ4X4YL	J.8, J.18, J.30, J.45
FRSPJC212YL	J.17
FRSPJC24YL	J.45
FRSPJC26YL	J.30
FRSPJC412YL	J.18
FRSPJC44YL	J.46
FRSPJC46YL	J.30
FRSSM2	J.47
FRSTRCLIP	J.47
FRT12X4W4YL	J.14
FRT12X4W6YL	J.14
FRT12X4YL	J.13
FRT24X4W12YL	J.5
FRT4X4YL	J.42
FRT6X4YL	J.26

Index by Part Number

Part Number	Page Number
FRTBKT-X	J.22, J.47
FRTBWG12BL	J.34, J.70
FRTBWG18BL	J.21, J.34, J.70
FRTBWG24BL	J.21, J.34, J.70
FRTBWG30BL	J.9, J.21, J.34, J.70
FRTCV24W12YL	J.5
FRTEL4	J.36
FRTEL6	J.36
FRTR12X4YL	J.19
FRTR24X4YL	J.8
FRTR4X4YL	J.8, J.19, J.31, J.46
FRTR6X4YL	J.17, J.32
FRTSC12W4YL	J.14
FRTSC12W6YL	J.14
FRTSC12YL	J.14
FRTSC4YL	J.42
FRTSC6YL	J.26
FRTYT68	J.37
FRUIB-X	J.47
FRUPS4X4YL	J.46
FRUPS6X4YL	J.32
FRVT12X4YL	J.17
FRVT4X4YL	J.44
FRVT6X4YL	J.29
FRWBS68	J.36
FRY126SCYL	J.16
FRY126YL	J.16
FS.5X.5LG6NM	P.11
FS.5X1LG6NM	P.11
FS.75X.75LG6NM	P.11
FS1.5X1.5LG6NM	P.11
FS1.5X1LG6NM	P.11
FS1.5X2LG6NM	P.11
FS1.5X3LG6NM	P.11
FS1X1.5LG6NM	P.11
FS1X1LG6NM	P.11
FS1X2LG6NM	P.11
FS1X3LG6NM	P.11
FS1X4LG6NM	P.11
FS2X1.5LG6NM	P.11
FS2X1LG6NM	P.11
FS2X2LG6NM	P.11
FS2X3LG6NM	P.11
FS2X4LG6NM	P.11
FS3X1LG6NM	P.11
FS3X2LG6NM	P.11
FS3X3LG6NM	P.11
FS3X4LG6NM	P.11
FS3X5LG6NM	P.11
FS4X1.5LG6	P.11
FS4X2LG6NM	P.11
FS4X3LG6NM	P.11
FS4X4LG6NM	P.11
FS4X5LG6NM	P.11
FS6X4LG6NM	P.11
FSC24	C.62
FSCBT2AQ-X	C.30
FSCBT2BU-X	C.19, C.22, C.26

Part Number	Page Number
FSCBT3AQ-X	C.26
FSCBT3BU-X	C.19, C.22
FSCBT3EI-X	C.26
FSCBT900AQ-X	C.26
FSCBT900EI-X	C.26
FSCC	C.101
FSCCLIP-L	C.22, C.26
FSCDM	C.26
FSCDM5BL	C.26
FSCDMC5BL	C.22
FSCDMC6EI	C.22
FSCDMCXAQ	C.22
FSCDVR	C.101, C.103
FSCM2.05BL	C.26
FSCM2.0BL	C.26
FSCM2.0RD	C.26
FSCM5BL	C.26
FSCMBL	C.26
FSCMRD	C.26
FSCMC5BL	C.22
FSCMC6EI	C.22
FSCMCXAQ	C.22
FSCP506Y	C.9
FSCP512Y	C.9
FSCP606Y	C.9
FSCP612Y	C.9
FSCP906Y	C.9
FSCP912Y	C.9
FSCR506Y	C.8
FSCR512Y	C.8
FSCR606Y	C.8
FSCR612Y	C.8
FSCR906Y	C.8
FSCR912Y	C.8
FSCRBLD	C.103
FSCRIBE	C.103
FSCS2.0BU	C.26
FSCSBU	C.26
FSCSCBU	C.22
FSDP506Y	C.5
FSDP512Y	C.5
FSDP524Y	C.5
FSDP536Y	C.5
FSDP606Y	C.5
FSDP612Y	C.5
FSDP624Y	C.5
FSDP636Y	C.5
FSDP906Y	C.5
FSDP912Y	C.5
FSDP924Y	C.5
FSDP936Y	C.5
FSDR506Y	C.4
FSDR512Y	C.4
FSDR524Y	C.4
FSDR536Y	C.4
FSDR606Y	C.4
FSDR612Y	C.4
FSDR624Y	C.4

Part Number	Page Number
FSDR636Y	C.4
FSDR906Y	C.4
FSDR912Y	C.4
FSDR924Y	C.4
FSDR936Y	C.4
FSGP506Y	C.12
FSGP512Y	C.12
FSGP606Y	C.12
FSGP612Y	C.12
FSGP906Y	C.12
FSGP912Y	C.12
FSGR506Y	C.11
FSGR512Y	C.11
FSGR606Y	C.11
FSGR612Y	C.11
FSGR906Y	C.11
FSGR912Y	C.11
FSIP502Y	C.18
FSIP602Y	C.18
FSIP902Y	C.18
FSIR502Y	C.18
FSIR602Y	C.18
FSIR902Y	C.18
FSMP524Y	C.12
FSMP536Y	C.12
FSMP624Y	C.12
FSMP636Y	C.12
FSMP924Y	C.12
FSMP936Y	C.12
FSMR524Y	C.11
FSMR536Y	C.11
FSMR624Y	C.11
FSMR636Y	C.11
FSMR924Y	C.11
FSMR936Y	C.11
FSNP524Y	C.9
FSNP536Y	C.9
FSNP624Y	C.9
FSNP636Y	C.9
FSNP924Y	C.9
FSNP936Y	C.9
FSNR524Y	C.8
FSNR536Y	C.8
FSNR624Y	C.8
FSNR636Y	C.8
FSNR924Y	C.8
FSNR936Y	C.8
FSP51211F100A	C.100
FSP51211F150A	C.100
FSP51211F200A	C.100
FSP51255F100A	C.98
FSP51255F150A	C.98
FSP51255F200A	C.98
FSP52411F100A	C.100
FSP52411F150A	C.100
FSP52411F200A	C.100
FSP52455F100A	C.98
FSP52455F150A	C.98

Index by Part Number

Part Number	Page Number
FSP52455F200A	C.98
FSP54811F100A	C.100
FSP54811F150A	C.100
FSP54811F200A	C.100
FSP54855F100A	C.98
FSP54855F150A	C.98
FSP54855F200A	C.98
FSP91211F100A	C.100
FSP91211F150A	C.100
FSP91211F200A	C.100
FSP91255F100A	C.98
FSP91255F150A	C.98
FSP91255F200A	C.98
FSP92411F100A	C.100
FSP92411F150A	C.100
FSP92411F200A	C.100
FSP92455F100A	C.98
FSP92455F150A	C.98
FSP92455F200A	C.98
FSP94811F100A	C.100
FSP94811F150A	C.100
FSP94811F200A	C.100
FSP94855F100A	C.98
FSP94855F150A	C.98
FSP94855F200A	C.98
FSP9506Y	C.7
FSP9512Y	C.7
FSP9524Y	C.7
FSP9536Y	C.7
FSP9606Y	C.7
FSP9612Y	C.7
FSP9624Y	C.7
FSP9636Y	C.7
FSP9906Y	C.7
FSP9912Y	C.7
FSP9924Y	C.7
FSP9936Y	C.7
FSPR506Y	C.6
FSPR512Y	C.6
FSPR524Y	C.6
FSPR536Y	C.6
FSPR606Y	C.6
FSPR612Y	C.6
FSPR624Y	C.6
FSPR636Y	C.6
FSPR906Y	C.6
FSPR912Y	C.6
FSPR924Y	C.6
FSPR936Y	C.6
FSPX1211F100A	C.99
FSPX1211F150A	C.99
FSPX1211F200A	C.99
FSPX1255F100A	C.97
FSPX1255F150A	C.97
FSPX1255F200A	C.97
FSPX2411F100A	C.99
FSPX2411F150A	C.99
FSPX2411F200A	C.99

Part Number	Page Number
FSPX2455F100A	C.97
FSPX2455F150A	C.97
FSPX2455F200A	C.97
FSPX4811F100A	C.99
FSPX4811F150A	C.99
FSPX4811F200A	C.99
FSPX4855F100A	C.97
FSPX4855F150A	C.97
FSPX4855F200A	C.97
FST24	C.62
FST24H3	C.62
FST6	C.62
FSTC	C.101
FSTHE	C.62
FSTHS	C.62
FSTK	C.62
FSTMABL	C.27
FSTMARD	C.27
FSTMC5BL	C.23
FSTMC6EI	C.23
FSTMCXAQ	C.23
FSTN506	C.14
FSTN512	C.14
FSTN524	C.14
FSTN536	C.14
FSTN606	C.14
FSTN612	C.14
FSTN624	C.14
FSTN636	C.14
FSTN906	C.14
FSTN912	C.14
FSTN924	C.14
FSTN936	C.14
FSTSABU	C.27
FSTSCBU	C.23
FSTY	C.101, C.102, C.104
FSWB-C	C.101, C.102, C.104
FSWN506	C.16
FSWN512	C.16
FSWN524	C.16
FSWN536	C.16
FSWN606	C.16
FSWN612	C.16
FSWN624	C.16
FSWN636	C.16
FSWN906	C.16
FSWN912	C.16
FSWN924	C.16
FSWN936	C.16
FSYR-X	C.103
FT2X2YL	J.60
FT4X4YL	J.60
FTDNS4X4YL	J.37
FTR2X2YL	J.7, J.18, J.30, J.45, J.54, J.61
FTR4X4YL	J.29, J.44, J.61
FTRBE12	J.63
FTRBE12M	J.63
FTRBE58	J.63

Part Number	Page Number
FTRBN12	J.63
FTRBN12M	J.63
FTRBN58	J.63
FTWZR	C.101, C.102, C.104
FUSB	J.63
FVFLPC-1.25SMY	C.101
FVFLPC-2.5SMY	C.101
FVT4X4YL	J.61
FVTHD2X2YL	J.54, J.61
FWBTL	C.101, C.103
FWME2	C.60
FWME4	C.60
FWME8	C.60
FWP-C	C.101, C.103
FWRKMAT	C.101, C.103
FX12D5-5M1Y	C.92
FXB10-NM1Y	C.63
FXB10A-NM1	C.72
FXB10B-NM1	C.72
FXB10C-NM1	C.72
FXB10D-NM1	C.72
FXB10E-NM1	C.72
FXB10F-NM1	C.72
FXB3-NM1Y	C.63
FXB6J-NM1Y	C.63
FXD3-3M1Y	C.63
FXD6J-NM1Y	C.63
FXD6P-3M1Y	C.64
FXD6P-6PM1Y	C.63
FXD6PW-3M1Y	C.74
FXD6PX-3M1Y	C.74
FXD6PY-3M1Y	C.74
FXD6PZ-3M1Y	C.74
FXE10-10M1Y	C.63
FXE10A-10AM1	C.72
FXE10A-10M1	C.73
FXE10B-10BM1	C.72
FXE10B-10M1	C.73
FXE10C-10CM1	C.72
FXE10C-10M1	C.73
FXE10D-10DM1	C.72
FXE10D-10M1	C.73
FXE10E-10EM1	C.72
FXE10E-10M1	C.73
FXE10F-10FM1	C.72
FXE10F-10M1	C.73
FXE3-10AM1	C.74
FXE3-10BM1	C.74
FXE3-10CM1	C.74
FXE3-10DM1	C.74
FXE3-10EM1	C.74
FXE3-10FM1	C.74
FXE3-10M1Y	C.64
FXE6P-10M1Y	C.64
FXF10-10M1Y	C.63
FXNLCMLE2RM001	C.70
FXNLCMLE2RM002	C.70
FXNLCMLE2RM003	C.70

Index by Part Number

Part Number	Page Number
FXNLCMLE2RM005	C.70
FXNMLMLE2RM001	C.70
FXNMLMLE2RM002	C.70
FXNLCMLE2RM0010	C.70
FXN0505RTPM001	C.96
FXP0505RTPM001	C.96
FXPE10A-NM1	C.73
FXPE10B-NM1	C.73
FXPE10C-NM1	C.73
FXPE10D-NM1	C.73
FXPE10E-NM1	C.73
FXPE10F-NM1	C.73
FZBA1.5X4	J.64
FZBLP	J.64
FZ12D5-5M1Y	C.92
FZE10-10M1	C.63
FZB10-NM1	C.63
FZB3-NM1	C.63
FZD3-3M1	C.63
FZE3-10M1	C.63
FZNLCMLE2RM001	C.70
FZNLCMLE2RM002	C.70
FZNLCMLE2RM003	C.70
FZNLCMLE2RM005	C.70
FZNLCMLE2RM0010	C.70
FZNMLMLE2RM001	C.70
FZNMLMLE2RM002	C.70
FZN0505RTPM001	C.96
FZP0505RTPM001	C.96

G

G.75X2BL6	P.10
G1.5X1.5BL6	P.10
G1.5X2BL6	P.10
G1.5X3BL6	P.10
G1.5X4BL6	P.10
G1X1.5BL6	P.10
G1X1BL6	P.10
G1X2BL6	P.10
G1X3BL6	P.10
G1X4BL6	P.10
G2.5X3BL6	P.10
G2X1BL6	P.10
G2X2BL6	P.10
G2X2L6EMI	P.4
G2X3BL6	P.10
G2X3L6EMI	P.4
G2X4BL6	P.10
G2X4L6EMI	P.4
G3X2BL6	P.10
G3X3BL6	P.10
G3X4BL6	P.10
G4X2BL6	P.10
G4X3BL6	P.10
G4X4BL6	P.10
G4X5BL6	P.10
GACB-1	M.31
GACB-2	J.72, M.31

Part Number	Page Number
GACB-3	J.72, M.31
GACBJ612U	M.31
GACBJ618U	M.31
GACBJ68U	M.31, J.72
GB2B0304TPI-1	M.29
GB2B0306TPI-1	M.29
GB2B0312TPI-1	M.29
GB2B0514TPI-1	M.29
GB2D0008TPI-1	M.30
GB2D0021TPI-1	M.30
GB2D0033TPI-1	M.30
GB2D0044TPI-1	M.30
GB2D0056TPI-1	M.30
GB4B0612TPI-1	M.29
GB4B0624TPI-1	M.29
GB4B1028TPI-1	M.29
GB4N0007TPI-1	M.30
GB4N0016TPI-1	M.30
GB4N0024TPI-1	M.30
GB4N0026TPI-1	M.30
GB4N0034TPI-1	M.30
GC-15A-Q	M.45
GC-18A-X	M.45
GC-22A-4	M.45
GEE144F-A-C	P.52
GEE144F-A-C0	P.52
GEE144FR-CY	P.52
GEE36FR-CY	P.52
GEE62F-A-C	P.52
GEE62F-A-C0	P.52
GEE62FR-CY	P.52
GEE99F-A-C	P.52
GEE99F-A-C0	P.52
GEE99FR-CY	P.52
GES144F-A-C	P.52
GES144F-A-C0	P.52
GES144FR-CY	P.52
GES36FR-CY	P.52
GES62F-A-C	P.52
GES62F-A-C0	P.52
GES62FR-CY	P.52
GES99F-A-C	P.52
GES99F-A-C0	P.52
GES99FR-CY	P.52
GJ6120UH	M.21
GJ6144UH	M.21
GJ6168UH	M.21
GJ6192UH	M.21
GJ6216UH	M.21
GJ6240UH	M.21
GJ6264UH	M.21
GJ6288UH	M.21
GJ672UH	M.21
GJ696UH	M.21
GJS61200	M.22
GJS6180U	M.22
GJS660U	M.19
GJS696U	M.19

Part Number	Page Number
GPB144-X	B.78, E.8
GPB24-X	B.79, E.8
GPB2884R2Y	B.77
GPB2884R4WJY	B.77
GPB432-X	B.78
GPB484R2Y	B.77
GPB484R4WJY	B.77
GPB72-X	B.79
GPBW144-X	B.78
GPBW24-X	B.79
GPBW432-X	B.78
GPBW72-X	B.79
GPC5E1-XY	B.80
GPC5E2-XY	B.80
GPCB4-CY	B.78
GPCB4-XY	B.78
GPCB5-CY	B.78
GPCB5-XY	B.78
GPDTM	B.83
GPDTMB	B.83
GPDTMH	B.83
GPKBW144Y	B.76
GPKBW24Y	B.76
GPKBW432Y	B.76
GPKBW72Y	B.76
GPKT724Y	B.79
GPL-14-X	M.44
GPL-15-X	M.44
GPL-16-X	M.44
GPL-22-X	M.44
GPL-28-X	M.44
GPL-34-3	M.44
GPL-8-Q	M.44
GPPC1IG14Y	B.82
GPPC1IG20Y	B.82
GPPC1IG3Y	B.82
GPPC1IG5Y	B.82
GPPC1IG7Y	B.82
GPPC1IG9Y	B.82
GPPC2IG14Y	B.82
GPPC2IG20Y	B.82
GPPC2IG3Y	B.82
GPPC2IG5Y	B.82
GPPC2IG7Y	B.82
GPPC2IG9Y	B.82
GPPC4IG14AY	B.81
GPPC4IG14BY	B.81
GPPC4IG14Y	B.81
GPPC4IG20AY	B.81
GPPC4IG20BY	B.81
GPPC4IG20Y	B.81
GPPC4IG3AY	B.81
GPPC4IG3BY	B.81
GPPC4IG3Y	B.81
GPPC4IG5AY	B.81
GPPC4IG5BY	B.81
GPPC4IG5Y	B.81
GPPC4IG7AY	B.81

Index by Part Number

Part Number	Page Number
GPPC4IG7BY	.B.81
GPPC4IG7Y	.B.81
GPPC4IG9AY	.B.81
GPPC4IG9BY	.B.81
GPPC4IG9Y	.B.81
GPQC07-1/0	.M.16
GPQC10-1/0	.M.16
GPQC12-1/0	.M.16
GPQC15-1/0	.M.16
GPQC17-1/0	.M.16
GPQC20-1/0	.M.16
GPST	.B.83
GPSTB	.B.83
GR12X4X24OSPG	.J.78
GR12X4X24PG	.J.78
GR12X4X48OSPG	.J.78
GR12X4X48PG	.J.78
GR12X6X24OSPG	.J.78
GR12X6X24PG	.J.78
GR12X6X48OSPG	.J.78
GR12X6X48PG	.J.78
GR21X4X24PG	.J.77
GR21X4X48PG	.J.77
GR21X6X24PG	.J.77
GR21X6X48PG	.J.77
GRBRC4PG	.J.79
GRBRC6PG	.J.79
GRCLAMPPG-X	.J.79
GRFWC21PG	.J.79
GRLC21X4PG	.J.79
GRLC21X6PG	.J.79
GRPB12PG	.J.79
GRPBPG	.J.79
GTH	.P.37
GTS	.P.37
GUBC500-6	.M.31
H	
H000X025H1C	.O.9
H000X025H2C	.O.9
H000X034H1C	.O.9
H000X034H2C	.O.9
H000X044H1C	.O.9
H000X044H2C	.O.9
H000X064H1C	.O.9
H000X064H2C	.O.9
H000X084H1C	.O.9
H000X084H2C	.O.9
H100X025H1C	.O.8
H100X025H2C	.O.8
H100X034H1C	.O.8
H100X034H2C	.O.8
H100X044H1C	.O.8
H100X044H2C	.O.8
H100X064H1C	.O.8
H100X064H2C	.O.8
H100X084H1C	.O.8
H100X084H2C	.O.8

Part Number	Page Number
H1.5X2BL6	.P.5
H1.5X3BL6	.P.5
H2X2BL6	.P.5
H2X2YL6	.J.52
H2X3BL6	.P.5
H2X4BL6	.P.5
H3X3BL6	.P.5
H3X4BL6	.P.5
H4X4BL6	.P.5
HA0A1C0CA10E1	.L.45
HA0A1D0CA10E1	.L.45
HA0A1M2CM10E1	.L.45
HA1A1C0CA10E1	.L.45
HA1A1D0CA10E1	.L.45
HA1A1M2CM10E1	.L.45
HB0A1M0BA06K1	.L.40
HB0A1M2BN06G1	.L.40
HB0A1M2BN12E1	.L.39
HB0A1M2BT08W1	.L.39
HB0A1M2BT10M1	.L.39
HB0B1E0BA06J1	.L.36
HB0B1E0BA08W1	.L.36
HB0B1E1BN12H1	.L.36
HB0B1F0BA06J1	.L.36
HB0B1F0BA08W1	.L.36
HB0B1F1BN12H1	.L.36
HB0B1L0BA06L1	.L.41
HB0B1L2BN06J1	.L.41
HB0B1L2BN12H1	.L.40
HB0B1L4BT08W1	.L.40
HB0B1L4BT10M1	.L.40
HB0B2C3BN03N1	.L.44
HB0B2G6BN12N1	.L.25
HB1A1M0BA06K1	.L.40
HB1A1M2BN06G1	.L.40
HB1A1M2BN12E1	.L.39
HB1A1M2BT08W1	.L.39
HB1A1M2BT10M1	.L.39
HB1B1E0BA06J1	.L.36
HB1B1E0BA08W1	.L.36
HB1B1E1BN12H1	.L.36
HB1B1F0BA06J1	.L.36
HB1B1F0BA08W1	.L.36
HB1B1F1BN12H1	.L.36
HB1B1L0BA06L1	.L.41
HB1B1L2BN06J1	.L.41
HB1B1L2BN12H1	.L.40
HB1B1L4BT08W1	.L.40
HB1B1L4BT10M1	.L.40
HC1.5BL6	.P.5
HC1.5LG6	.P.6, P.7
HC2BL6	.P.5
HC2LG6	.P.6, P.7
HC2YL6	.J.52
HC3BL6	.P.5
HC3LG6	.P.6, P.7
HC4BL6	.P.5
HC4LG6	.P.6, P.7

Part Number	Page Number
HDCRT	.C.106
HDW1/4-KT	.M.22
HDW1/4-A-KT	.M.22
HDW3/8-KT	.M.22
HDW3/8-A-KT	.M.22
HLB2S-C0	.P.20
HLM-15R0	.P.20
HLS-15R0	.P.20
HLS-75R0	.P.20
HLS1.5S-X0	.P.20
HLS3S-X0	.P.20
HLS5S-X0	.P.20
HLSP1.5S-X0	.P.21
HLSP1.5S-X12	.P.21
HLSP3S-X0	.P.21
HLSP3S-X12	.P.21
HLSP5S-X0	.P.21
HLSP5S-X12	.P.21
HLT2I-X0	.P.20
HLT2I-M0	.P.20
HLT3I-X0	.P.20
HLT3I-M0	.P.20
HLTP2I-X0	.P.20
HLTP2I-X12	.P.20
HLTP3I-X0	.P.20
HLTP3I-X12	.P.20
HLTT1.5S-C20	.P.22
HLTT1.5S-Q20	.P.22
HN1.5X2LG6	.P.6
HN1.5X3LG6	.P.6
HN2X2LG6	.P.6
HN2X3LG6	.P.6
HN2X4LG6	.P.6
HN3X3LG6	.P.6
HN3X4LG6	.P.6
HN4X4LG6	.P.6
HNLW12	.J.73
HNLW12M	.J.73
HS1.5X2LG6NM	.P.7
HS1.5X3LG6NM	.P.7
HS2X2LG6NM	.P.7
HS2X2YL6NM	.J.52
HS2X3LG6NM	.P.7
HS2X4LG6NM	.P.7
HS3X3LG6NM	.P.7
HS3X4LG6NM	.P.7
HS4X4BL6	.E.6
HS4X4LG6NM	.P.7
HSECFR0.5-XY	.P.50
HSECFR0.8-XY	.P.50
HSECFR1.0-XY	.P.50
HSECFR1.5-5Y	.P.50
HSECFR2.0-5Y	.P.50
HTCT2-2-1	.M.41, M.58
HTCT250-2-1	.M.41, M.58
HTCT250-250-1	.M.41, M.58
HTCT6X-6X-1	.M.41, M.58
HTWC2-2-1	.M.42

Index by Part Number

Part Number	Page Number
HTWC250-2-1	M.42
HTWC250-250-1	M.42
HTWC6X-6X-1	M.42
I	
IABDIN4	N.4
IAEBH5E	N.6
IAEBH5ES	N.6
IAEBH6	N.5
IAEBH6S	N.5
IAEBHC5E	N.7
IAEBHC6	N.5
IAEBHUSBAA	N.7
IAEFP1	N.9
IAEFP2-2G	N.9
IAEF617P-7PM1	N.8
IAEF617P-NM1	N.8
IAEF7JMA	N.8
IAPNGWH	N.9
IAPNG5EWH	N.9
IAPNWH	N.9
IAR4P48CN	N.4
IAZ1214	N.3
IAZ1214C	N.3
IAZ2424	N.3
IAZ2424C	N.3
IAZ2436	N.3
IAZ2436C	N.3
ICF10IW-X	K.19
ICF3IW-E	K.19
ICF5IW-E	K.19
ICFC10IW-X	K.20
ICFC3IW-X	K.20
ICFC5IW-X	K.20
ISTPCH1MBLY	N.8
ISTPCHNC1MBLY	N.8
ISTPSP1MBL	N.6
ISTPSPNC1MBL	N.6
IUTPCH3BLY	N.8
IUTPCHNC3BLY	N.8
IUTPSP3BL	N.6
IUTPSPNC3BL	N.6
J	
JB1DIW-A	K.25
JB1FSDIW-A	K.26
JB1FSIW-A	K.26
JB1IW-A	K.25
JBA-X	K.25
JBP1FSIW	K.26
JBP2DIW	K.25
JBP2FSIW	K.26
JBP2IW	K.25
JBP3DIW	K.25
JBX3510IW-A	K.25
JMCB-X	L.97
JMCMB25-1-X	L.97
JMCMB25-3-X	L.97

Part Number	Page Number
JMDWB-1-X	L.97
JMDWB-3-X	L.97
JMJH2W-X20	L.97
JMJH2-X20	L.97
JMSBCB87-1-X	L.97
JMSBCB87-3-X	L.97
JMTRB38-1-X	L.97
JMTRB38-3-X	L.97
JP131CM-L20	L.92
JP131CP-L20	L.94
JP131DW-L20	L.92
JP131HBC25R-L20	L.93
JP131HBC50R-L20	L.93
JP131HBC75R-L20	L.93
JP131SBC50-L20	L.93
JP131SBC50R-L20	L.93
JP131SBC87-L20	L.93
JP131SBC87R-L20	L.93
JP131UF100-L20	L.94
JP131W-L20	L.92
JP131WP2-L20	L.92
JP131ZP-L20	L.94
JP2CM-L20	L.92
JP2CP-L20	L.94
JP2DW-L20	L.92
JP2HBC25R-L20	L.93
JP2HBC50R-L20	L.93
JP2HBC75R-L20	L.93
JP2SBC50-L20	L.93
JP2SBC50R-L20	L.93
JP2SBC87-L20	L.93
JP2SBC87R-L20	L.93
JP2UF100-L20	L.94
JP2W-L20	L.92
JP2WP2-L20	L.92
JP2ZP-L20	L.94
JP4CM-X20	L.92
JP4CP-X20	L.94
JP4HBC25R-X20	L.93
JP4HBC50R-X20	L.93
JP4HBC75R-X20	L.93
JP4SBC50R-X20	L.93
JP4SBC50-X20	L.93
JP4SBC87R-L20	L.93
JP4SBC87-X20	L.93
JP4UF100-X20	L.94
JP4WP-X20	L.92
JP4W-X20	L.92
JP4ZP-X20	L.94
JP75CM-L20	L.92
JP75CP-L20	L.94
JP75DW-L20	L.92
JP75HBC25R-L20	L.93
JP75HBC50R-L20	L.93
JP75HBC75R-L20	L.93
JP75SBC50-L20	L.93
JP75SBC50R-L20	L.93
JP75SBC87-L20	L.93

Part Number	Page Number
JP75SBC87R-L20	L.93
JP75UF100-L20	L.94
JP75W-L20	L.92
JP75WP2-L20	L.92
JP75ZP-L20	L.94
K	
KHDCRT-FL	C.106
KHDCRT-LCE	C.106
KHDCRT-SCE	C.106
KP1-C	M.40
KP2-L	M.40
KPCRT1-FL	B.98, C.104
KWP5EY	G.17
KWP6PY	G.17
L	
LCC1/0-12W-X	M.37
LCC1/0-14AW-X	M.37
LCC1/0-38DW-X	M.37
LCC1/0-W	M.50
LCC10-14AW-L	M.36
LCC10-14JAW-L	M.36
LCC10-14JAWF-L	M.36
LCC10-14JAWH-L	M.36
LCC10-W	M.50
LCC2-12W-Q	M.37
LCC2-14AW-Q	M.37
LCC2-38DW-Q	M.37
LCC2-W	M.50
LCC2/0-12W-X	M.37
LCC2/0-14AW-X	M.37
LCC2/0-38DW-X	M.37
LCC2/0-W	M.50
LCC250-12W-X	M.37
LCC250-38DW-X	M.37
LCC250-W	M.50
LCC3/0-12W-X	M.37
LCC3/0-38DW-X	M.37
LCC3/0-W	M.50
LCC350-12W-X	M.38
LCC350-38DW-X	M.38
LCC350-W	M.52
LCC4/0-12W-X	M.37
LCC4/0-38DW-X	M.37
LCC4/0-W	M.50
LCC400-12W-6	M.38
LCC400-38DW-6	M.38
LCC400-W	M.52
LCC4-12W-L	M.37
LCC4-14AW-L	M.37
LCC4-38DW-L	M.37
LCC4-W	M.50
LCC500-12W-6	M.38
LCC500-38DW-6	M.38
LCC500-W	M.52
LCC600-12W-6	M.38
LCC600-38DW-6	M.38

Index by Part Number

Part Number	Page Number
LCC600-W	M.52
LCC6-10ABW-L	M.37
LCC6-12W-L	M.37
LCC6-14AW-L	M.37
LCC6-14JAW-L	M.37
LCC6-14JAWF-L	M.37
LCC6-14JAWH-L	M.37
LCC6-38DW-L	M.37
LCC6-W	M.50
LCC750-12W-6	M.38
LCC750-38DW-6	M.38
LCC750-W	M.52
LCC8-10AW-L	M.36
LCC8-14AWF-L	M.36
LCC8-14AWH-L	M.36
LCC8-38DW-L	M.36
LCC8-W	M.50
LCCX1/0	M.54
LCCX1/0-12-X	M.40
LCCX1/0-14A-X	M.40
LCCX1/0-38D-X	M.40
LCCX2	M.54
LCCX2-12-E	M.40
LCCX2-14A-E	M.40
LCCX2-38D-E	M.40
LCCX2/0	M.54
LCCX2/0-12-X	M.40
LCCX2/0-14A-X	M.40
LCCX2/0-38D-X	M.40
LCCX250	M.54
LCCX250-38D-X	M.40
LCCX3/0	M.54
LCCX3/0-38D-X	M.40
LCCX350	M.54
LCCX350-12-6	M.40
LCCX350-38D-6	M.40
LCCX4	M.54
LCCX4-14A-L	M.40
LCCX4-38D-L	M.40
LCCX4/0	M.54
LCCX4/0-12-X	M.40
LCCX4/0-38D-X	M.40
LCCX450	M.54
LCCX450-12-6	M.40
LCCX450-38D-6	M.40
LCCX500	M.54
LCCX500-12-6	M.40
LCCX500-38D-6	M.40
LCCX6	M.54
LCCX6-14A-L	M.39
LCCX6-14AF-L	M.39
LCCX6-14AH-L	M.39
LCCX6-38D-L	M.39
LCCX650	M.54
LCCX650-12-6	M.40
LCCX8	M.54
LCCX8-14A-L	M.39
LCCX8-14AF-L	M.39

Part Number	Page Number
LCCX8-14AH-L	M.39
LCCX8-38D-L	M.39
LD10IW10-A	K.18
LD10IW6-A	K.18
LP10IW8-A	K.18
LD3IW10-A	K.18
LD3IW6-A	K.18
LD3IW8-A	K.18
LD5IW10-A	K.18
LD5IW6-A	K.18
LD5IW8-A	K.18
LIAC4-22-C	M.32
LIAS1/0-14-L	M.32
LIAS250-56-Q	M.32
LICC4-22-C	M.32
LICC4-22TP-C	M.32
LJSL4-Y3-2.5	C.103
LS8-CASE	O.2
LS8-CLN	O.2
LS8-IB	O.2
LS8-PCKIT	O.2
LS8-WS	O.2
LS8E	O.2
LS8E-ACS	O.2
LS8E-KIT	O.2
LS8E-KIT-ACS	O.2
LS8EQ	O.2
LS8EQ-KIT	O.2
LS8EQ-KIT-ACS	O.2
LS9	O.2
LS9-ACS	O.2
LS9-CASE	O.2
LS9-CLN	O.2
LS9-IB	O.2
LS9-WS	O.2
LS9Q	O.2
LTYK	M.29
LV-S-1G	G.29
LV-S-2G	G.29
LV-W-1G	G.29
LV-W-2G	G.29
LWC100-A-L	P.43
LWC100-A-L14	P.43
LWC100-A-L20	P.43
LWC100-H25-L	P.43
LWC100-H25-L14	P.43
LWC100-H25-L20	P.43
LWC19-A-C	P.43
LWC19-A-C14	P.43
LWC19-A-C20	P.43
LWC19-H25-C	P.43
LWC19-H25-C14	P.43
LWC25-A-C	P.43
LWC25-A-C14	P.43
LWC25-A-C20	P.43
LWC25-H25-C	P.43
LWC25-H25-C14	P.43
LWC25-H25-C20	P.43

Part Number	Page Number
LWC38-A-C	P.43
LWC38-A-C14	P.43
LWC38-A-C20	P.43
LWC38-H25-C	P.43
LWC38-H25-C14	P.43
LWC50-A-L	P.43
LWC50-A-L14	P.43
LWC50-A-L20	P.43
LWC50-H25-L	P.43
LWC50-H25-L14	P.43
LWC50-H25-L20	P.43
LWC75-A-L	P.43
LWC75-A-L14	P.43
LWC75-A-L20	P.43
LWC75-H25-L	P.43
LWC75-H25-L14	P.43
LWC75-H25-L20	P.43
M	
M200X050ACT	O.20
M200X050AET	O.20
M200X050AFT	O.20
M200X050AGT	O.20
M200X050AIT	O.20
M200X050Y6T	O.20
M200X050Y7T	O.20
M200X100ACT	O.20
M200X100AET	O.20
M200X100AFT	O.20
M200X100AGT	O.20
M200X100AIT	O.20
M200X100Y6T	O.6
M200X100Y7T	O.20
M300X050ACT	O.20
M300X050AET	O.20
M300X050AFT	O.20
M300X050AGT	O.20
M300X050AIT	O.20
M300X050Y6C	O.6
M300X050Y6T	O.20
M300X050Y7C	O.6
M300X050Y7T	O.20
M300X100ACT	O.20
M300X100AET	O.20
M300X100AFT	O.20
M300X100AGT	O.20
M300X100AIT	O.20
M300X100Y6T	O.20
M300X100Y7T	O.20
MDC-C	B.97
MFFPEBL	G.19
MIWBAIW	G.18
MP588-C	B.47
MP588-L	B.47
MP588-M	B.47
MPI588T	N.7
MPSI588T	N.7
MPS588-C	B.51

Index by Part Number

Part Number	Page Number
MPT5-8A	.B.98
MS14B	.H.3
MS14BHD	.H.3
MS14HD	.H.3
MS24B	.H.3
MS24BHD	.H.3
MS24HD	.H.3
MS4S1G	.H.4
MS4S2G	.H.4
MS5E6PP	.H.5
MS8PD	.H.4
MS8PE	.H.4
MS8PP	.H.5
MS8S1G	.H.4
MS8S2G	.H.4
MSB14E	.H.3
MSB24E	.H.3
MCLK	.H.5
MSCM-KIT	.H.5
MSCMR	.H.5
MSEBRKT	.H.5
MSG-1.3-C	.L.94
MSGV-1.3-C	.L.94
MSGRD-KIT	.H.5
MSP500W	.G.18
MSP-1.3	.L.94
MWBA1	.G.17
MWBA-2G	.G.17
N	
N050X075C1C	.O.7
N050X075C2C	.O.7
N050X125C1C	.O.7
N050X125C2C	.O.7
N100X075C1C	.O.7
N100X075C2C	.O.7
N100X125C1C	.O.7
N100X125C2C	.O.7
NACACT5F08DSBL	.L.24
NC25LG2	P.8
NC37LG2	P.8
NC50LG2	P.8
NC75LG2	P.8
NC100LG2	P.8
NCMH2	L.79
NCMHF1	.L.79
NCMHF2	.L.79
NM1	L.78
NM1B	.L.78
NM2	L.78
NM2B	.L.78
NM3	.L.78
NM3B	.L.78
NM4	.L.78
NM4B	.L.78
NMF1	L.78
NMF2	L.78
NMF3	.L.78

Part Number	Page Number
NMF4	.L.78
NNC25X25LG2	P.8
NNC25X37LG2	P.8
NNC25X50LG2	P.8
NNC25X75LG2	P.8
NNC37X37LG2	P.8
NNC37X50LG2	P.8
NNC37X75LG2	P.8
NNC50DWH2	P.8
NNC50X50LG2	P.8
NNC50X75LG2	P.8
NNC50X100LG2	P.8
NNC75DWH2	P.8
NNC75X75LG2	P.8
NNC100X50LG2	P.8
NNC100X75LG2	P.8
NNC100X100LG2	P.8
NR2WH-L	.J.62
NR4BL-L	.J.62
NRD10	L.74
NRD12	L.74
NRD6	L.74
NREP	L.74, L.75
NRV6	L.74
NRV10	L.74
NRV12	L.74
NRVCB	L.74
NRVF10	L.74
NRVF12	L.74
NRVF6	L.74
NSCAC06F04IRBL	.L.24
NSCAC06F06IRBL	.L.24
NSCAC07F04IRBL	.L.24
NSCAC07F06IRBL	.L.24
NSMOR07A4548BL	.L.31
NSRDF06R0042BL	.L.31
NSRDF06R0045BL	.L.31
NSRDF07R0042BL	.L.31
NSRDF07R0045BL	.L.31
NSVED0611632BL	.L.31
NSVED0613266BL	.L.31
NSVED0711632BL	.L.31
NSVED0713266BL	.L.31
NWSLC-2Y	.O.18
NWSLC-2Y-AQ	O.18
NWSLC-3Y	O.18
NWSLC-7Y	O.18
NWSLC2-2Y	O.18
NWSLC2-2Y-AQ	O.18
NWSLC2-3Y	O.18
NWSLC2-7Y	O.18
O	
OCF10IW-X	.K.19
OCF3IW-E	.K.19
OCF5IW-E	.K.19
OCFX10IW-X	.K.20
OCFX3IW-X	.K.20

Part Number	Page Number
OCFX5IW-X	.K.20
OCTT	.C.101
OF70FH20B	.K.11
OF70FH40B	.K.11
OF70FV20B	.K.11
OF70FV40B	.K.11
OF70PGOB	.K.11
OF70POB	.K.11
OF70ECOB	.K.10
OF70OB6	.K.8
OF70C70OB6	.K.8
OFR20CCOB-X	.K.11
OFR20CPOB8	.K.9
OFR20CROB	.K.10
OFR20DMBOB	.K.10
OFR20DSOOb	.K.10
OFR20ECOB	.K.11
OFR20ICOB	.K.11
OFR20LCOB	.K.11
OFR20MPTOB	.K.10
OFR20OB6	.K.8
OFR20OB8	.K.8
OFR20OCOB	.K.11
OFR20OFCR70OB1	.K.9
OFR20OFCR70OB1P	.K.9
OFR20OFCR70OB2	.K.9
OFR20OFCR70OB2P	.K.9
OFR20OFCR70OB4	.K.9
OFR20OFCR70OB4P	.K.9
OFR20RAOB	.K.10
OFR20SOOB	.K.10
OFR20TOB	.K.10
OFR20WEOB	.K.10
OFVR50B6	.K.8
P	
P10-10R-L	.M.35
P10-12R-L	.M.35
P10-14R-L	.M.35
P10-38R-L	.M.35
P10-56R-L	.M.35
P10-8R-L	.M.35
P110B100-X	.B.89, E.8
P110B1004R2Y	.B.86
P110B1004R4WJY	.B.86
P110B1005R2Y	.B.86
P110B1005R4WJY	.B.86
P110B100R2BY	.B.85
P110B100R2Y	.B.85
P110B100R4BY	.B.85
P110B100R4WJY	.B.85
P110B300-X	.B.89
P110BW100-X	.B.89
P110BW300-X	.B.89
P110CB3-CY	.B.88
P110CB3-XY	.B.88
P110CB4-CY	.B.88
P110CB4-XY	.B.88

Index by Part Number

Part Number	Page Number
P110CB5-CY	.B.88
P110CB5-XY	.B.88
P110JT-X	.B.83, B.91
P110JTR2Y	.B.83, B.91
P110JTW-X	.B.83, B.91
P110KB1004Y	.B.84
P110KB1005Y	.B.84
P110KB3004Y	.B.84
P110KB3005Y	.B.84
P110KT3004Y	.B.86
P110KT3005Y	.B.86
P110KT9004Y	.B.86
P110KT9005Y	.B.86
P110LH	.B.87
P110PC1-XY	.B.89
P110PC1IG2Y	.B.90
P110PC1IG4Y	.B.90
P110PC1IG5Y	.B.90
P110PC1IG6Y	.B.90
P110PC2-XY	.B.89
P110PC2IG2Y	.B.90
P110PC2IG4Y	.B.90
P110PC2IG5Y	.B.90
P110PC2IG6Y	.B.90
P110PC3-XY	.B.89
P110PC4-XY	.B.89
P110PC4IG2AY	.B.90
P110PC4IG2BY	.B.90
P110PC4IG2Y	.B.90
P110PC4IG4AY	.B.90
P110PC4IG4BY	.B.90
P110PC4IG4Y	.B.90
P110PC4IG5AY	.B.90
P110PC4IG5BY	.B.90
P110PC4IG5Y	.B.90
P110PC4IG6AY	.B.90
P110PC4IG6BY	.B.90
P110PC4IG6Y	.B.90
P110T300Y	.B.86
P110T900Y	.B.86
P110TB300Y	.B.88
P110TB900Y	.B.88
P110VCM	.B.87
P110VCM300	.B.87
P110VCM900	.B.87
P14-10R-C	.M.35
P14-12R-L	.M.35
P14-14R-C	.M.35
P14-38R-C	.M.35
P14-56R-C	.M.35
P14-8R-C	.M.35
P2-12R-X	.M.35
P2-14R-X	.M.35
P2-38R-X	.M.35
P2-56R-X	.M.35
P32W2A2-50-7	.P.13
P32W2A2-50-72	.P.13
P32W2A2-50-7	.P.13

Part Number	Page Number
P32W2A2-50-72	.P.13
P32W2A2-75-7	.P.13
P32W2A2-75-72	.P.13
P32W2A2-50-7	.P.13
P32W2A2-75-72	.P.13
P32W2A2-75-7	.P.13
P32W2A2-75-72	.P.13
P4-12R-E	.M.35
P4-14R-E	.M.35
P4-38R-E	.M.35
P4-56R-E	.M.35
P515C13BL1.5	.L.58
P515C13BL3	.L.58
P515C13BL6	.L.58
P515C13BL7	.L.58
P515C13GY3	.L.58
P515C13GY6	.L.58
P515C19BL1.5	.L.58
P515C19BL3	.L.58
P515C19BL6	.L.58
P520C19BL1.5	.L.58
P520C19BL3	.L.58
P520C19BL6	.L.58
P6-10R-E	.M.35
P6-12R-E	.M.35
P6-14R-E	.M.35
P6-38R-E	.M.35
P6-56R-E	.M.35
P620C19BL1.5	.L.58
P620C19BL3	.L.58
P620C19BL6	.L.58
P8-10R-Q	.M.35
P8-12R-Q	.M.35
P8-14R-Q	.M.35
P8-38R-Q	.M.35
P8-56R-Q	.M.35
PBDCT	.P.15
PBDCT-BLD	.P.15
PC14C13BL1.5	.L.57
PC14C13BL2	.L.57
PC14C13BL3	.L.57
PC14C13BL4	.L.57
PC14C13BL5	.L.57
PC14C13BL6.5	.L.57
PC14C13BL7	.L.57
PC14C13BL8	.L.57
PC14C13BL9	.L.57
PC14C13BL10	.L.57
PC14C13GY1.5	.L.57
PC14C13GY2	.L.57
PC14C13GY3	.L.57
PC14C13GY4	.L.57
PC14C13GY	.L.57
PC14C13GY6.5	.L.57
PC14C13GY7	.L.57
PC14C13GY8	.L.57
PC14C13GY9	.L.57
PC14C13GY10	.L.57

Part Number	Page Number
PC20C13BL1.5	.L.57
PC20C13BL3	.L.57
PC20C13BL6	.L.57
PC20C19BL3	.L.57
PC20C19BL4	.L.57
PC20C19BL5	.L.57
PC20C19BL6	.L.57
PC20C19GY3	.L.57
PC20C19GY4	.L.57
PC20C19GY5	.L.57
PC20C19GY6	.L.57
PCBANDBL-Q	.B.96
PCBANDBU-Q	.B.96
PCBANDEI-Q	.B.96
PCBANDGR-Q	.B.96
PCBANDIG-Q	.B.96
PCBANDOR-Q	.B.96
PCBANDRD-Q	.B.96
PCBANDVL-Q	.B.96
PCBANDWH-Q	.B.96
PCBANDYL-Q	.B.96
PCRT1	.B.98, C.104
PCV-110AY	.O.29
PCV-110BY	.O.29
PCV-110CY	.O.29
PCV-115AY	.O.29
PCV-115BY	.O.29
PCV-115CY	.O.29
PCV-120/208AY	.O.29
PCV-120/208BY	.O.29
PCV-120/208CY	.O.29
PCV-120AY	.O.29
PCV-120BY	.O.29
PCV-120CY	.O.29
PCV-120RY	.O.30
PCV-12470AY	.O.29
PCV-12470BY	.O.29
PCV-12470CY	.O.29
PCV-13200AY	.O.29
PCV-13200BY	.O.29
PCV-13200CY	.O.29
PCV-13800AY	.O.29
PCV-13800BY	.O.29
PCV-13800CY	.O.29
PCV-1PHAY	.O.29
PCV-1PHBY	.O.29
PCV-1PHCY	.O.29
PCV-208AY	.O.29
PCV-208BY	.O.29
PCV-208CY	.O.29
PCV-220AY	.O.29
PCV-220BY	.O.29
PCV-220CY	.O.29
PCV-2300AY	.O.29
PCV-2300BY	.O.29
PCV-2300CY	.O.29
PCV-230AY	.O.29
PCV-230BY	.O.29

Index by Part Number

Part Number	Page Number	Part Number	Page Number	Part Number	Page Number
PCV-230CY	.O.29	PCV-MAINCY	.O.29	PLC2S-S10-C	.P.29
PCV-2400AY	.O.29	PCV-TELEAY	.O.29	PLC2S-S6-C	.P.29
PCV-2400BY	.O.29	PCV-TELEBY	.O.29	PLC3S-S10-C	.P.29
PCV-2400CY	.O.29	PCV-TELECY	.O.29	PLC4H-S25-L	.P.29
PCV-240AY	.O.29	PDB110M	.B.91	PLC4S-S10-C	.P.29
PCV-240BY	.O.29	PDH110M	.B.91	PLF1M-C	.P.30
PCV-240CY	.O.29	PDT110	.B.91	PLF1MA-C	.P.30
PCV-24VDCBY	.O.29	PDT110M	.B.91	PLF1MB-C	.P.30
PCV-277/480AY	.O.29	PDTH110	.B.91	PLF1MC-M	.P.30
PCV-277/480BY	.O.29	PEB1	.L.83	PLM1M-C	.P.30
PCV-277/480CY	.O.29	PEB2	.L.83	PLM2M-C	.P.30
PCV-277AY	.O.29	PED10	.L.67, L.72	PLM2S-C	.P.30
PCV-277BY	.O.29	PED12	.L.67, L.72	PLM4S-C	.P.30
PCV-277CY	.O.29	PED6	.L.67, L.72	PLT1.5I-C	.P.28
PCV-380AY	.O.29	PED8	.L.67, L.72	PLT1.5M-C	.P.28
PCV-380BY	.O.29	PEDK10	.L.72	PLT1.5S-C	.P.28
PCV-380CY	.O.29	PEDK12	.L.72	PLT10LH-L	.P.28
PCV-3PHAY	.O.29	PEDK6	.L.72	PLT13H-Q	.P.28
PCV-3PHBY	.O.29	PEDK8	.L.72	PLT1M-C	.P.28
PCV-3PHCY	.O.29	PEHF2	.L.80	PLT1M-C702Y	.P.29
PCV-415AY	.O.29	PEHF3	.L.80	PLT1M-L0	.P.36
PCV-415BY	.O.29	PEHF4	.L.80	PLT1M-L1	.P.36
PCV-415CY	.O.29	PEV10	.L.67	PLT1M-L1-0	.P.36
PCV-4160AY	.O.29	PEV12	.L.67	PLT1M-L1-10	.P.36
PCV-4160BY	.O.29	PEV6	.L.67	PLT1M-L1-2	.P.36
PCV-4160CY	.O.29	PEV8	.L.67	PLT1M-L1-4	.P.36
PCV-440AY	.O.29	PEVBRC10	.L.68	PLT1M-L1-7	.P.36
PCV-440BY	.O.29	PEVBRC12	.L.68	PLT1M-L2	.P.36
PCV-440CY	.O.29	PEVBRC6	.L.68	PLT1M-L3	.P.36
PCV-460AY	.O.29	PEVBRC8	.L.68	PLT1M-L3-0	.P.36
PCV-460BY	.O.29	PEVEP	.L.68	PLT1M-L3-10	.P.36
PCV-460CY	.O.29	PEVF10	.L.67	PLT1M-L3-2	.P.36
PCV-480AY	.O.29	PEVF12	.L.67	PLT1M-L3-4	.P.36
PCV-480BY	.O.29	PEVF6	.L.67	PLT1M-L3-7	.P.36
PCV-480CY	.O.29	PEVF8	.L.67	PLT1M-L4Y	.P.36
PCV-480RY	.O.30	PFP5504BU-UY	.B.47	PLT1M-L5	.P.36
PCV-600AY	.O.29	PFR5504BU-UY	.B.47	PLT1M-L5-0	.P.36
PCV-600BY	.O.29	PFR6X04BU-CG	.B.14	PLT1M-L5-10	.P.36
PCV-600CY	.O.29	PFX-0	.C.101, C.103, P.27	PLT1M-L5-2	.P.36
PCV-BLANKAY	.O.29	PFX-2	.P.27	PLT1M-L5-4	.P.36
PCV-BLANKBY	.O.29	PHQ4SFPXA1MBL	.B.7	PLT1M-L5-7	.P.36
PCV-BLANKCY	.O.29	PIM-ASSET	.I.6	PLT1M-L6	.P.36
PCV-ESAY	.O.29	PIM-AYAINT	.I.6	PLT1M-L6-0	.P.36
PCV-ESBY	.O.29	PIM-BASE	.I.6	PLT1M-L6-10	.P.36
PCV-ESCY	.O.29	PIM-BMCINT	.I.6	PLT1M-L6-2	.P.36
PCV-FAAY	.O.29	PIM-CAMA	.I.6	PLT1M-L6-4	.P.36
PCV-FABY	.O.29	PIM-CONNECT	.I.6	PLT1M-L6-7	.P.36
PCV-FACY	.O.29	PIM-DASHBOARD	.I.6	PLT1M-L8	.P.36
PCV-FOAY	.O.29	PIM-DASHBOARD	.I.6	PLT1M-L8-0	.P.36
PCV-FOBY	.O.29	PIM-ENT	.I.6	PLT1M-L8-10	.P.36
PCV-FOCAY	.O.29	PIM-IBMINT	.I.6	PLT1M-L8-2	.P.36
PCV-FOCBY	.O.29	PIM-MSFTINT	.I.6	PLT1M-L8-4	.P.36
PCV-FOCCY	.O.29	PIM-POWER	.I.6	PLT1M-L8-7	.P.36
PCV-FOCY	.O.29	PIMS-MEDIA	.I.6	PLT1S-C	.P.28
PCV-FOMY	.O.30	PL2M2S-L	.P.30	PLT2.5H-L	.P.28
PCV-FORY	.O.30	PL3M2S-L	.P.30	PLT2.5I-C	.P.28
PCV-MAINAY	.O.29	PLC1.5I-S8-C	.P.29	PLT2.5S-C	.P.28
PCV-MAINBY	.O.29	PLC1M-S4-C	.P.29	PLT2H-L	.P.28
		PLC2H-S25-L	.P.29		

Index by Part Number

Part Number	Page Number	Part Number	Page Number	Part Number	Page Number
PLT2I-C	P.28	PPS0305W2100	O.27	PSL-DCJB-VL	B.92
PLT2M-C	P.28	PPS0507W2100	O.27	PSL-DCPLRX	B.94
PLT2S-C	P.28	PPS0507W2100-F	O.27	PSL-DCPLRX-BL	B.94
PLT2S-C702Y	P.29	PPS0710G001	O.26	PSL-DCPLRX-BU	B.94
PLT3H-L	P.28	PPS0710G020	O.26	PSL-DCPLRX-GR	B.94
PLT3I-C	P.28	PPS1014G002	O.26	PSL-DCPLRX-IG	B.94
PLT3S-C	P.28	PPS1209G010	O.26	PSL-DCPLRX-IW	B.94
PLT3S-C702Y	P.29	PPS1209G011	O.26	PSL-DCPLRX-OR	B.94
PLT4.5S-C	P.28	PPS1209G012	O.26	PSL-DCPLRX-YL	B.94
PLT4H-L	P.28	QSFQA1MBU	B.6	PSL-DCPLRX-VL	B.94
PLT4I-C	P.28	QSFQA2MBU	B.6	PSL-DCPLX	B.94
PLT4S-C	P.28	QSFQB3MBU	B.6	PSL-DCPLX-BL	B.94
PLT5EH-Q	P.28	QSFQC4MBU	B.6	PSL-DCPLX-BU	B.94
PLT5H-L	P.28	QSFQD5MBU	B.6	PSL-DCPLX-GR	B.94
PLT5S-C	P.28	QSFQA0.5MBU	B.16	PSL-DCPLX-IG	B.94
PLT6EH-Q	P.28	QSFPA1MBU	B.15	PSL-DCPLX-IW	B.94
PLT6H-L	P.28	QSFPA2MBU	B.16	PSL-DCPLX-OR	B.94
PLT6LH-L	P.28	QSFPA3MBU	B.16	PSL-DCPLX-YL	B.94
PLT7LH-L	P.28	QSFPA4MBU	B.16	PSL-DCPLX-VL	B.94
PLT8H-L	P.28	QSFPA5MBU	B.16	PSL-LCAB	C.82
PLT8LH-L	P.28	QSFPA6MBU	B.16	PSL-PERM-USBA	C.93
PLT9LH-L	P.28	QSFPA7MBU	B.16	PSL-PERM-USBb	C.93
PMV1-5RB-CY	M.32	PROG-CCCD	O.12	PSL-SCBD	C.82
PMV1-6RB-CY	M.32	PROG-EM2GO	O.11	PSL-USBA	C.93
PMV2-5RB-C	M.32	PROG-EMCD3	O.11	PSL-USBB	C.93
PMV2-6RB-C	M.32	PRD10	L.71	PSM7004BU-KD	B.15
PMV6-5R-L	M.32	PRD12	L.71	PSM7004BU-KM	B.15
PMV6-6R-L	M.32	PRD15	L.72	PST-FO	O.26
PMV6-8R-L	M.32	PRD6	L.71	PST-FOBLNK	O.26
PN1A1B0BA10B1	L.50	PRD8	L.71	PT2S-ARW	O.30
PN1A1C0BA10E1	L.50	PREP	L.72	PT2S-BLK	O.30
PN1A1D0BA10E1	L.50	PRSHD12	L.72	PT2S-RED	O.30
PN1A1D0BA12M1	L.50	PRSHD6	L.72	PTR-CLN	O.12
PN10-610R-L	M.34	PRSHD8	L.72	PUP6X04BU-UG	B.14
PN14-610R-C	M.34	PRSP5	L.72, L.75	PUPR6X04BU-UG	B.14
PNF10-10R-L	M.34	PRSP7	L.72	PUM-049-M30	P.41
PNF10-14R-L	M.34	PRV10	L.71	PUM-071-M30	P.41
PNF10-38R-L	M.34	PRV12	L.71	PUM-100-M30	P.41
PNF10-56R-L	M.34	PRV15	L.71	PUM-925-M30	P.41
PNF10-8R-L	M.34	PRV6	L.71	PUP5525IG-UY	B.52
PNF14-10R-C	M.34	PRV8	L.71	PUP5504BU-UY	B.39
PNF14-14R-C	M.34	PRVF10	L.71	PUP6004BU-UY	B.27
PNF14-38R-L	M.34	PRVF12	L.71	PUP6504BU-UY	B.26
PNF14-56R-C	M.34	PRVF15	L.71	PUP6A04BU-UG	B.19
PNF14-8R-C	M.34	PRVF6	L.71	PUP6ASD04BU-CG	B.19
PP1S-S10-X	L.44	PRVF8	L.71	PUR5504BU-UY	B.39
PP1S-S12-X	L.44	PSF1AXA3MBL	B.5	PUR5525IG-UY	B.52
PP2S-S10-X	L.44	PSF1AXD7MBU	B.15	PUR6004BU-UY	B.27
PP2S-S12-X	L.44	PSF1PXA1MBU	B.14	PUR6504BU-UY	B.26
PP5X50F	P.37	PSF1PXD4MBU	B.14	PUR6A04BU-UG	B.19
PPC25X50	P.37	PSL-DCJB	B.92	PUR6ASD04BU-UG	B.19
PPC25X50F	P.37	PSL-DCJB-BL	B.92	PV10-8RX-L	M.33
PPF2S-S25-V	L.44	PSL-DCJB-BU	B.92	PV10-10RX-L	M.33
PPF2S-S25-V69	L.44	PSL-DCJB-GR	B.92	PV10-14RX-L	M.33
PPF2SV-S25-V	L.44	PSL-DCJB-IG	B.92	PV10-38RX-L	M.33
PPF2SV-S25-V69	L.44	PSL-DCJB-IW	B.92	PV10-56RX-L	M.33
PPS0204W2100	O.27	PSL-DCJB-OR	B.92	PV14-10RX-C	M.33
PPS0204W2100-F	O.27	PSL-DCJB-YL	B.92	PV14-14RX-L	M.33

Index by Part Number

Part Number	Page Number
PV14-8RX-C	.M.33
PV14-38RX-L	.M.33
PV14-56RX-L	.M.33
PV2-12RX-XY	.M.33
PV2-14RX-XY	.M.33
PV2-38RX-XY	.M.33
PV2-56RX-XY	.M.33
PV4-12RX-E	.M.33
PV4-14RX-E	.M.33
PV4-38RX-E	.M.33
PV4-56RX-E	.M.33
PV6-10RX-X	.M.33
PV6-14RX-X	.M.33
PV6-38RX-X	.M.33
PV6-56RX-X	.M.33
PV8-10RX-QY	.M.33
PV8-12RX-XY	.M.33
PV8-14RX-QY	.M.33
PV8-38RX-QY	.M.33
PV8-56RX-QY	.M.33
PVF9L10-10M0.5Y	.I.11
PVFXL10-10M0.5Y	.I.11
PVQ-BIU6C1MBU	.I.10
PVQ-BIU6C3BU	.I.10
PVQ-BIU6L1MBU	.I.10
PVQ-EPC14	.I.9
PVQ-ES6X1MBU	.I.10
PVQ-ES6X3BU	.I.10
PVQ-ESDP	.L.56
PVQ-ESDP-NA	.L.56
PVQ-ESDP-NS	.L.56
PVQ-EST-18	.L.56
PVQ-ESTAFHD-18	.L.56
PVQ-ESW	.L.56
PVQ-EU6AC1MBU	.I.10
PVQ-EU6AC3BU	.I.10
PVQ-EM	.I.9
PVQ-FMT	.I.8
PVQ-FMTMTP-ZX	.I.8
PVQ-FMTMTP-9	.I.8
PVQ-MIQAPCVR	.I.7
PVQ-MIQAPS24	.I.7
PVQ-MIQAPU24	.I.7
PVQ-MIQPS24	.I.7
PVQ-MIQPS96A	.I.7
PVQ-MIQPS96F	.I.7
PVQ-MIQPU24	.I.7
PVQ-PM	.I.9
PVQ-PS12VDC-C	.I.9
PVQ-PS12VDC-E	.I.9
PVQ-PS12VDC-J	.I.9
PVQ-PS12VDC-S	.I.9
PVQ-PS12VDC-U	.I.9
PVQ-RD	.L.56
PVQ9PE10LQM00.5	.I.11
PVQXPE10LQM00.5	.I.11
PVQZPE10LQM00.5	.I.11
PVS0204D2101Y	.O.27

Part Number	Page Number
PVS0204W2103Y	.O.27
PVS0305D2101Y	.O.27
PVS0305W2102Y	.O.27
PVS0305W2102Y-S	.O.27
PVS0305W2103Y	.O.27
PVS0507D2101Y	.O.27
PVS0507W2103Y	.O.27
PVS0507W2104Y-0	.O.28
PVS0507W2104Y-1	.O.28
PVS0507W2104Y-2	.O.28
PVS0507W2104Y-3	.O.28
PVS0507W2104Y-4	.O.28
PVS0507W2106Y-0	.O.28
PVS0507W2106Y-1	.O.28
PVS0507W2106Y-2	.O.28
PVS0507W2106Y-3	.O.28
PVS0507W2106Y-4	.O.28
PVS0705D2105Y-S	.O.27
PVS0705W2105Y-S	.O.27
PVSTP6X1MBBU	.I.11
PVUTP6X1MBBU	.I.11
PVUTPSPC3BBUY	.I.11
PVUTPSPC1MBBUY	.I.11
PW100F-C	.P.48
PW100F-C20	.P.48
PW100F-C3	.P.48
PW100F-C4	.P.48
PW100FR-C20Y	.P.48
PW100FR-CY	.P.48
PW150F-L	.P.48
PW150F-L20	.P.48
PW150F-L3	.P.48
PW150F-L4	.P.48
PW150FR-L20Y	.P.48
PW150FR-LY	.P.48
PW38FR-TL20Y	.P.48
PW38FR-TLY	.P.48
PW38F-TL	.P.48
PW38F-TL20	.P.48
PW50FR-T20Y	.P.48
PW50FR-TY	.P.48
PW50F-T	.P.48
PW50F-T20	.P.48
PW50F-T3	.P.48
PW50F-T4	.P.48
PW75F-C	.P.48
PW75F-C20	.P.48
PW75F-C3	.P.48
PW75F-C4	.P.48
PW75FR-C20Y	.P.48
PW75FR-CY	.P.48
PWT100	.P.49
PWT150	.P.49
PWT38	.P.49
PWT50	.P.49
PWT75	.P.49
PX-0	.P.30
PX-2	.P.30

Part Number	Page Number
PXDR	.B.75
PXLK-VI	.B.75
PXMT50	.B.75
PXMT300	.B.75
PXPCB4	.B.75
PXPCB5	.B.75
PZ1A1C0BA20E1	.L.46
PZ1A1D0BA20E1	.L.46
PZ1B2G3BN03L1	.L.49
PZ1B2G6BN12N1	.L.48
PZAEFAN	.E.5
PZAEFK-E	.E.5
PZAEVK	.E.5, M.23
PZAELOCK	.E.5
PZAEWM3	.E.5
PZB4	.E.8
PZB4-FC	.E.8
PZB4-HC	.E.8
PZBASE3	.E.5
PZBASELK	.E.5
PZBPPB	.E.8
PZBR3	.E.4
PZBR3.5	.C.61
PZBR4	.E.4
PZC12P	.E.4
PZC12S	.E.4
PZC12W	.E.4
PZCFK	.E.4
PZCFK-E	.E.4
PZCFR	.E.4
PZCGK	.E.4
PZCHSM2	.E.4
PZICE	.E.3
PZICEA	.E.3
PZICFK-E	.E.3
PZICFRK	.E.3
PZICGK	.E.3
PZLRB2U	.E.6
PZLRB4U	.E.6
PZLRB6U	.E.6
PZNDVK	.F.5, N.3
PZNF1	.F.5, N.3
PZNF2	.F.5, N.3
PZNF3	.F.5, N.3
PZNWE12	.F.5
PZNWE12S	.F.5
PZNWE14	.F.5
PZNWE14S	.F.5
PZRFC	.E.7
PZRFE12U	.E.7
PZRFE4U	.E.7
PZRFE8U	.E.7
PZW2X2CB	.F.4
PZW2X2DCB	.F.4
PZWC35	.F.3
PZWC35E	.F.3
PZWC35I	.F.3
PZWIFCB	.F.4

Index by Part Number

Part Number	Page Number
PZWIFIDCB	.F.4
PZWIFIE	.F.3
PZWIFIEA	.F.3
PZWIFIED	.F.3
PZWIFIEH	.F.4
PZWIFIEN	.F.3
PZWIFIENA	.F.3
PZWIFIERN	.F.4
PZWIFIEW	.F.4
PZWRKA	.F.4

Q

QAPP24BL	.B.12, C.58
QAPP48HDBL	.B.12, C.58
QAPP48HDVNSBL	.B.12, C.58
QASP24BL	.B.12
QASP48HDBL	.B.12
QD0B1L2BN0861	.L.51
QL1B1F0BA2401	.L.53
QL1B1J0BA240	.L.53
QL1B1L2BN24AA1	.L.53
QL1B1N3BN2401	.L.54
QL1B1P3BN2491	.L.54
QL1B2G6BN2491	.L.54
QL1D1K0BA2401	.L.53
QL1D1Q3BN2401	.L.54
QL1D2A0BA2401	.L.55
QL1D2B2BN24AA1	.L.55
QL1D2P3BN2401	.L.55
QL1D2Q0BA2401	.L.55
QNOA1M2BM24E1	.L.50
QN1A1C0BA24E1	.L.50
QN1A1J0BA24E1	.L.50
QN1A1P3BN24E1	.L.50
QN1A1P3BN30P1	.L.50
QN1B1J0BA30P1	.L.50
QN1B1L2BN0861	.L.51
QN1B1L2BN24H1	.L.50
QN1B1L2BN30P1	.L.50
QN1B1P3BN24H1	.L.52
QN1B1P3BN30P1	.L.52
QN1B2G6BN24R1	.L.52
QN1D2A0BA30P1	.L.52
QN1D2B2BN30P1	.L.52
QN1D2P3BN30P1	.L.52
QN1D2Q0BA30P1	.L.52
QPP24BL	.B.12, C.58
QPP48HDBL	.B.12, C.58
QPP48HDVNSBL	.B.12, C.58
QPAZCBAB07	.B.10
QPPABL	.B.12, C.58
QPPACBAB07	.B.6
QPPBBL	.B.12, C.58
QPPCCBAB07	.B.10
QPPEDBAB07	.B.10
QPPLC24	.B.12, C.58
QPPLD6-X	.B.13
QPPLD8-X	.B.13

Part Number	Page Number
QPPN6BU	.B.13
QPPN8BU	.B.13
QPPN12BU	.B.13
QPPNR6S	.B.13
QPPRT	.B.13
QPPZCBAB07	.B.6
QSP24BL	.B.12, C.58
QSP48HDBL	.B.12, C.58
QQ1B6A4AP12N1	.L.48
QQ1C1P3BN24Y1	.L.47
QZ1A1C0BA24E1	.L.46
QZ1A1C0BA30P1	.L.46
QZ1A1J0BA30P1	.L.46
QZ1A1M2BM24E1	.L.47
QZ1A1P3BN30P1	.L.47
QZ1B1E0BA24H1	.L.46
QZ1B1E0BA30P1	.L.46
QZ1B1J0BA30P1	.L.46
QZ1B1L2BN1441	.L.47
QZ1B1L2BN24H1	.L.46
QZ1B1P3BN30P1	.L.48
QZ1B2C3BN30P1	.L.48
QZ1B2G3BN03L1	.L.49
QZ1B2G5BN2271	.L.49
QZ1B2G6BN06L1	.L.49
QZ1B2G6BN24Z1	.L.48
QZ1C1P3BN1851	.L.48
QZ1C1P3BN24Y1	.L.47
QZ1C1P3BN33X1	.L.47
QZ1D1K0BA30P1	.L.46
QZ1D1Q3BN30P1	.L.48
QZ1D2A0BA30P1	.L.49
QZ1D2B2BM30P1	.L.49
QZ1D2P3BN30P1	.L.49
QZ1D2Q0BA30P1	.L.49

R

R050X075V1T	.O.19
R050X125V1T	.O.19
R050X150V1T	.O.19
R100X075V1C	.O.6
R100X075V1T	.O.19
R100X125V1C	.O.6
R100X125V1T	.O.19
R100X150V1C	.O.6
R100X150V1T	.O.19
R100X150V2T	.O.19
R100X150V3T	.O.19
R100X150V7T	.O.19
R100X150V8T	.O.19
R100X225V1C	.O.6
R100X225V1T	.O.19
R100X225V2T	.O.19
R100X225V3T	.O.19
R100X225V7T	.O.19
R100X225V8T	.O.19
R100X400V1T	.O.20
R200X150V1T	.O.20

Part Number	Page Number
R200X225V1T	.O.20
R200X225V1T	.O.20
R2P	.L.63
R2P48	.L.63
R2P6S	.L.63
R2P6S96	.L.63
R2P96	.L.63
R2PAE2	.L.63
R2PAEI	.L.63
R2PPDUB	.L.63
R2PPEVWF	.L.63
R2PPRVWF	.L.63
R2PW	.L.63
R4P	.L.60
R4P23	.L.60
R4P23CN	.L.60
R4PAE2	.L.61
R4PAE3	.L.61
R4PCN	.L.60
R4P36	.L.60
R4P36CN	.L.60
R4P42	.L.60
R4P42CN	.L.60
R4P2396	.L.61
R4P96	.L.61
R4P3696	.L.61
R4P4296	.L.61
R4P23CN96	.L.61
R4PCN96	.L.61
R4P36CN96	.L.61
R4P42CN96	.L.61
RSHLF23	.L.61
RSHLF36	.L.61
RSHLF	.L.61
R4PAEI	.L.61
R4PFL	.L.62
R4PFM	.L.62
R4PFP	.L.62
R4PFR	.L.62
R4PRT	.L.62
R4PRCN	.L.62
R4PWF	.L.61
RAEFXIW-X	.K.20
RAF10IW-X	.K.19
RAF3IW-E	.K.19
RAF5IW-E	.K.19
RAF10IW-X	.K.20
RAF3IW-X	.K.20
RAF5IW-X	.K.20
RCSTR	.L.61
RF10X3IW-X	.K.19
RF10X5IW-X	.K.19
RF5X3IW-E	.K.19
RFA-KIT	.L.62, L.63
RFG10X8SMY	.L.90, L.91
RFG10X8Y	.L.90, L.91
RFG12X4SMY	.L.90, L.91
RFG12X4Y	.L.90, L.91

Index by Part Number

Part Number	Page Number
RFG12X8SMY	.L.90, L.91
RFG12X8Y	.L.90, L.91
RFG3DSMY	.L.90, L.91
RFG3DY	.L.90, L.91
RFG5DSMY	.L.90, L.91
RFG5DY	.L.90, L.91
RFG6X8SMY	.L.90, L.91
RFG6X8Y	.L.90, L.91
RFG8X8SMY	.L.90, L.91
RFG8X8Y	.L.90, L.91
RFX103IW-X	.K.20
RFX105IW-X	.K.20
RFX53IW-X	.K.20
RGCBNJ660P22	.M.16, L.62
RGCBNJ660PY	.M.16
RGESD2-1	.M.24
RGESD2B-1	.M.24
RGESDWS	.M.24
RGEJ1024PHY	.M.19
RGEJ1024PFY	.M.19
RGEJ1024URT	.M.19
RGEJ1036PFY	.M.19
RGEJ1057PFY	.M.19
RGEJ624PHY	.M.19
RGEJ624PFY	.M.19
RGEJ636PFY	.M.19
RGEJ657PFY	.M.19
RGEJ660PF	.M.19
RGEJ660U	.M.19
RGEJ696PF	.M.19
RGEJ696U	.M.19
RGRB19CN	.M.17, M.28
RGRB19U	.M.17, M.28
RGRB19Y	.M.17, M.28
RGREJ1096Y	.M.28
RGREJ696Y	.M.28
RGRKCBNJEJY	.M.28
RGRKCBNJY	.M.28
RGS134-1Y	.M.17
RGS134-10-1Y	.M.17
RGS134B-1	.M.17
RGS134B-10-1	.M.17
RGTBS1032G-C	.M.25
RGTBSG-C	.M.25
RGTBSM5G-C	.M.25
RGTBSM6G-C	.M.25
RGTS1032-C	.M.25
RGTS-CY	.M.25
RGTSM5-C	.M.25
RGTSM6-C	.M.25
RGW-100-1Y	.M.26
RJBX3510IW	.K.25
RMEH2BL	.O.13
RMEH4BL	.O.13
RMEH4BL	.O.13
RMEH4BL	.O.13
RMER4BL	.O.13
RMER4BL-A	.O.13

Part Number	Page Number
RMER4RD	.O.13
RMER4WH	.O.13
RNRV10	.L.64
RNRV6	.L.64
RPSH103C13TL6M	.L.23
RPSH163C13TL6	.L.23
RPSV243520TL5	.L.24
RPSV243620TL6	.L.24
RPSV303C139TL6	.L.24
RWMPV45E	.L.64
RWMPVF45E	.L.64
RWMPVHC45E	.L.64
RWMPVHCF45E	.L.64

S

S050X075VAC	.O.5
S050X075VATY	.O.16
S050X075YAJ	.O.23
S050X125VAC	.O.5
S050X125VATY	.O.16
S050X125YAJ	.O.23
S050X150VAC	.O.5
S050X150VATY	.O.16
S050X150YAJ	.O.23
S075X075VAC	.O.16
S075X075YAJ	.O.23
S075X100VAC	.O.5
S075X125VAC	.O.5
S075X125VATY	.O.16
S075X125YAJ	.O.23
S075X150VAC	.O.5
S075X150VATY	.O.16
S075X150YAJ	.O.23
S100X075VAC	.O.5
S100X075VATY	.O.16
S100X075YAJ	.O.23
S100X125VAC	.O.5
S100X125VATY	.O.16
S100X125YAJ	.O.23
S100X150VAC	.O.5
S100X150VATY	.O.16
S100X150V0TY	.O.16
S100X150V9TY	.O.17
S100X150VATY	.O.16, O.18
S100X150VBTY	.O.16
S100X150VCTY	.O.16
S100X150VDTY	.O.16
S100X150VETY	.O.16
S100X150VFTY	.O.16
S100X150VGTY	.O.16
S100X150VHTY	.O.16
S100X150VITY	.O.16
S100X150YAJ	.O.23
S100X150YBJ	.O.23
S100X150YCJ	.O.23
S100X150YDJ	.O.23
S100X150YEJ	.O.23
S100X150YFJ	.O.23

Part Number	Page Number
S100X150YGJ	.O.23
S100X150YHJ	.O.23
S100X150YIJ	.O.23
S100X160VAC	.O.5
S100X160YAJ	.O.24
S100X220VAC	.O.5
S100X220YAJ	.O.24
S100X225VAC	.O.5
S100X225V0TY	.O.17
S100X225V9TY	.O.17
S100X225VATY	.O.17, O.18
S100X225VBTY	.O.17
S100X225VCTY	.O.17
S100X225VDTY	.O.17
S100X225VETY	.O.17
S100X225VFTY	.O.17
S100X225VGTY	.O.17
S100X225VHTY	.O.17
S100X225VITY	.O.17
S100x225YAJ	.O.24
S100X225YBJ	.O.24
S100X225YCJ	.O.24
S100X225YDJ	.O.24
S100X225YEJ	.O.24
S100X225YFJ	.O.24
S100X225YGJ	.O.24
S100X225YHJ	.O.24
S100X225YIJ	.O.24
S100X400VAC	.O.5
S100X400VATY	.O.17
S100X400YAJ	.O.24
S100X650VAC	.O.5
S100X650VATY	.O.17
S100X650YAJ	.O.24
S1224-C	.L.33
S150X150VATY	.O.17
S150X225VATY	.O.17
S150X400VATY	.O.17
S150X400YAJ	.O.24
S150X400YIJ	.O.24
S200X150VATY	.O.17, O.18
S200X150YAJ	.O.24
S200X225VATY	.O.17, O.18
S200X225YAJ	.O.24
S200X400VATY	.O.17
S200X400YAJ	.O.24
S200X650VATY	.O.17
S200X650YAJ	.O.24
S22PS	.L.32
S2X2YL6NM	.J.59
S4X4YL6NM	.J.59
S52PS	.L.32
S62DS	.L.33
S62DSH	.L.33
S65DS	.L.33
S65DSH	.L.33
S72DS	.L.33
S72DSH	.L.33

Index by Part Number

Part Number	Page Number
S75DS	L.33
S75DSH	L.33
S620C122B	L.27
S620C129B	L.27
S622C122B	L.27
S622C122F	L.28
S622C122H	L.30
S622C129B	L.27
S622C129F	L.28
S622C129H	L.30
S622C131HV	L.31
S622C131HVR	L.31
S62BRCK	L.33
S62BRFK	L.32
S62RC	L.32
S652C122B	L.27
S652C122F	L.28
S652C122H	L.30
S652C129B	L.27
S652C129F	L.28
S652C129H	L.30
S652C131HV	L.31
S652C131HVR	L.31
S65BRCK	L.33
S65BRFK	L.32
S65RC	L.32
S722C122B	L.27
S722C122F	L.28
S722C122H	L.30
S722C122P	L.29
S722C129B	L.27
S722C129F	L.28
S722C129H	L.30
S722C129P	L.29
S722C131HV	L.31
S722C131HVR	L.31
S72BRCK	L.33
S72BRFK	L.32
S752C122B	L.27
S752C122F	L.28
S752C122H	L.30
S752C122P	L.29
S752C129B	L.27
S752C129F	L.28
S752C129H	L.30
S752C129P	L.29
S752C131HV	L.31
S752C131HVR	L.31
S75BRCK	L.33
S75BRFK	L.32
S72RC	L.32
S75RC	L.32
S75S2C122B	L.32
SACS50-T100	P.34
SAJPBU25BL	E.9
SAJRBU25BL	E.9
SAPPBU25	E.9
SAPRBU25	E.9

Part Number	Page Number
SBC3-C	M.45
SBCT3-C	M.45
SBQC1/0-X	M.16
SCSTR	L.32
SD2EMI	P.4
SD3EMI	P.4
SD4EMI	P.4
SD2H6	P.13
SD3H6	P.13
SD4H6	P.13
SD2HWH6	P.13
SD2HWH6	P.13
SD4HWH6	P.13
SDCLIP	P.4
SE125P-LR0	P.50
SE125PSC-LR0	P.50
SE12PSC-TR0	P.50
SE12P-TR0	P.50
SE150P-LR0	P.50
SE150PSC-LR0	P.50
SE175P-TR0	P.50
SE25PSC-TR0	P.50
SE25P-TR0	P.50
SE38PSC-TR0	P.50
SE38P-TR0	P.50
SE50P-CR0	P.50
SE50PSC-CR0	P.50
SE75P-CR0	P.50
SE75PSC-CR0	P.50
SLCT-IG	B.90
SLCT-OR	B.90
SLCT-WH	B.90
SLCT-YL	B.90
SP688-C	B.35
SPS688-C	B.38
SRB19BLY	B.74
SRB19D5BL	B.74, L.68
SRB19D7BL	B.74, L.68
SRB19MDBL	B.74
SRBBRKT	B.74
SRBCT	B.74
SRBM19BLY	B.74
SRBS19BL-XY	B.74
SRBWCY	B.74
SRFS-KIT	L.32
SRM19X18A1	L.83
SRM19X25A1	L.83
SRM19CM3	L.83
SRM19CMV3	L.83
SRM19FM1	L.83
SRM19FM2	L.83
SSGK-1	M.20
ST3EH	P.37
STH2	P.37
STP6X3IG	B.14
STPCH1MBBL	B.46
STPK6X3BL	B.14
STPKCH3BL	B.46

Part Number	Page Number
STS2	P.37
SVPDUB	L.32
SVPPB	L.32
T	
T019X000FJC-BK	O.10
T024X000FJC-BK	O.10
T024X000VPC-BK	O.10
T024X000VYC-WH	O.10
T024X000YKC-BK	O.10
T031X000FJC-BK	O.10
T038X000C1C-BK	O.7
T038X000C2C-BK	O.7
T038X000FJC-BK	O.10
T038X000VPC-BK	O.10
T038X000VQC-BK	O.10
T038X000VSC-BK	O.10
T038X000VUC-BK	O.10
T038X000VWC-BK	O.10
T038X000VXC-BK	O.10
T038X000VYC-WH	O.10
T038X000YKC-BK	O.10
T050X000C1C-BK	O.7
T050X000C2C-BK	O.7
T050X000VPC-BK	O.10
T050X000VQC-BK	O.10
T050X000VSC-BK	O.10
T050X000VUC-BK	O.10
T050X000VWC-BK	O.10
T050X000VXC-BK	O.10
T050X000VYC-WH	O.10
T050X000YKC-BK	O.10
T075X000C1C-BK	O.7
T075X000C2C-BK	O.7
T075X000VPC-BK	O.10
T075X000VQC-BK	O.10
T075X000VSC-BK	O.10
T075X000VUC-BK	O.10
T075X000VWC-BK	O.10
T075X000VXC-BK	O.10
T075X000VYC-WH	O.10
T075X000YKC-BK	O.10
T100X000C1C-BK	O.7
T100X000C2C-BK	O.7
T100X000VPC-BK	O.10
T100X000VQC-BK	O.10
T100X000VSC-BK	O.10
T100X000VUC-BK	O.10
T100X000VWC-BK	O.10
T100X000VXC-BK	O.10
T100X000VYC-WH	O.10
T100X000YKC-BK	O.10
T200X000YY2T	O.30
T400X000A91	O.28
T400X000Y2T	O.30
T400X000YX1	O.28
T50F-C	P.49
T50F-C0	P.49

Index by Part Number

Part Number	Page Number
T50F-C1	P.49
T50F-C10	P.49
T50F-C16	P.49
T50F-C2	P.49
T50F-C3Y	P.49
T50F-C4Y	P.49
T50F-C5	P.49
T50F-C6	P.49
T50F-C7	P.49
T50F-C8	P.49
T50FR-C20Y	P.49
T50FR-CY	P.49
T70FH2IW	K.23
T70FH4IW	K.23
T70FV2IW	K.23
T70FV4IW	K.23
T70PGIW	K.23
T70PGSIW	K.23
T70PIW	K.23
T70PSIW	K.23
T70SDB-X	K.11
TDP43ME	O.12
TDP43ME-AC	O.12
TDP43ME-CASE	O.12
TDP43ME-CUTTER	O.12
TDP43ME-KIT	O.12
TDP43ME-R	O.12
TF10IW-X	K.19
TF3IW-E	K.19
TF5IW-E	K.19
TFC10IW-X	K.20
TFC3IW-X	K.20
TFC5IW-X	K.20
TGJT	B.97
TLBP1R-V	L.85
TLBP1S-V	L.85
TLBP2R-V	L.85
TLBP2S-V	L.85
TM1S4-C	P.40
TM1S4-C0	P.40
TM1S6-C	P.40
TM1S6-C0	P.40
TM2S6-C	P.40
TM2S6-C0	P.40
TM2S8-C	P.40
TM2S8-C0	P.40
TM3S10-C	P.40
TM3S10-C0	P.40
TM3S2510-C30	P.40
TM3S2510-C39	P.40
TM3S25-C	P.40
TM3S25-C0	P.40
TM3S8-C	P.40
TM3S8-C0	P.40
TMEH-S10-C100	P.40
TMEH-S10-Q0	P.40
TMEH-S25-Q0	P.40
TMEH-S8-Q0	P.40

Part Number	Page Number
TNC25LG2	P.9
TNC37LG2	P.9
TNC50D2	P.9
TNC50LG2	P.9
TNC75D2	P.9
TNC75LG2	P.9
TNC100LG2	P.9
TNC25X37LG2	P.9
TNC25X75LG2	P.9
TNC37X37LG2	P.9
TNC37X75LG2	P.9
TNC50X50LG2	P.9
TNC75X75LG2	P.9
TNC100X50LG2	P.9
TNC100X75LG2	P.9
TPA32R88S68Y	B.56
TPK1A32R88S68Y	B.56
TPK2A32R88S68	B.56
TR1-12-X	J.48
TR1-58-X	J.48
TRBSK	M.26
TRBSM6K	M.26
TRC18FR-X8	J.48, L.99
TRC18FR-X20Y	J.48, L.99
TRC2BL	J.62, P.14
TRC2HDBL	J.7, J.18, J.30, J.45, J.54, P.14
TRC4BL	J.62, P.14
TRC4HDBL	J.8, J.17, J.29, J.44, P.14
TTS-20R0	P.21
TTS-35R3-0	P.21
TTS-35RX0	P.21
U	
UAJPBU25BL	E.9
UAJRBU25BL	E.9
UAPPBU25	E.9
UAPRBU25	E.9
UCT3S-X0	P.21
UCT5S-X0	P.21
UCTGS1224-X	P.21
UCTGSM5-X	P.21
UCTGSM6-X	P.21
UGCTC3S-X0	P.21
UGCTC5S-X0	P.21
UGCTE3S-X0	P.21
UGCTE5S-X0	P.21
UICBX2IW-A	G.22
UICBX4IW-A	G.22
UICBXA12IW-A	G.25
UICBXH6IW-A	G.22
UICBXHC6IW-A	G.22
UICBXHECIW	G.22
UICFFP4BL	G.18
UICFP2IW	G.3
UICFP4IW	G.3
UICFP6IW	G.3
UICFP2S	G.11

Part Number	Page Number
UICFP4S	G.11
UICFP6S	G.11
UICFPH2IW	G.3
UICFPH4IW	G.3
UICFPHSE2IW	G.6
UICFPHSE4IW	G.6
UICFPRTR4IW	G.9
UICFPSE2IW	G.6
UICFPSE4IW	G.6
UICFPSE6IW	G.6
UICFPSE8IW-2G	G.6
UICIDIW-C	G.27
UICIIW-C	G.27
UICMPP24BLY	B.66
UICMPP48BLY	B.66
UICMPPA24BLY	B.66
UICMPPA48BLY	B.66
UICMPPK6G24BL	B.30
UICMPPKA6G24BL	B.30
UICPP2L4BL	B.66
UICPPL4BL	B.66
UILC1CL-X	G.27
UILC2CL-X	G.27
UILC3CL-X	G.27
UILC4CL-X	G.27
UILC6CL-X	G.27
UILJ1	O.21
UILJ2	O.21
UILJ3	O.21
UILJ4	O.21
UILJ6	O.21
UILJCOMBO	O.21
UILS8BW	O.11
UISW	O.15
UIT70FH2IW	K.22
UIT70FH4IW	K.22
UIT70FV2IW	K.22
UIT70FV4IW	K.22
UIWOL1-L	G.28
UIWOL2-L	G.28
UIWOL3-L	G.28
UIWOL4-L	G.28
UIWOL6-L	G.28
UJPBU25BLY	E.9
UJRBU25BLY	E.9
UPPBU25Y	E.9
UPRBU25Y	E.9
UTP6A3	B.25
UTP6ASD3	B.25
UTPK6A3BL	B.25
UTPCH3Y	B.46
UTPKCH3BL	B.46
UTPCH8L25Y	B.55, B.52
UTPCH8LR25Y	B.55, B.52
UTPCH8R25Y	B.55, B.52
UTPCH8SL25Y	B.55, B.52
UTPCH8SMRJ25	B.52
UTPCH8SR25Y	B.55, B.52

Index by Part Number

Part Number	Page Number
UTPCH812PP25Y	.B.55
UTPCH86PP25	.B.52
UTPKCH3BL	.B.42
UTPKSP3BL	.B.34
UTPSP3Y	.B.34
V	
VB0A1J0BA24E1	.L.38
VB0A1J0BA30P1	.L.38
VB0A1M2BM24E1	.L.41
VB0A1M2BM30P1	.L.41
VB0A1M2CN24E1	.L.41
VB0A1P3BN24E1	.L.42
VB0B1E0CA20H1	.L.38
VB0B1F0CA20H1	.L.38
VB0B1J0BA24H1	.L.38
VB0B1L2BN12J1	.L.42
VB0B1L4BT24M1	.L.42
VB0B2C3BN30P1	.L.44
VB0B2G6BN12N1	.L.44
VB0B2G6BN24Z1	.L.44
VB0B6A4AP12N1	.L.44
VB0C1J0BA18V1	.L.39
VB0C1J0BA30U1	.L.39
VB0C1P3BN24Y1	.L.43
VB0C1P3BN33X1	.L.43
VB1A1J0BA24E1	.L.38
VB1A1J0BA30P1	.L.38
VB1A1M2BM24E1	.L.41
VB1A1M2BM30P1	.L.41
VB1A1M2CN24E1	.L.41
VB1A1P3BN12G1	.L.42
VB1A1P3BN24E1	.L.42
VB1A1P3BN30P1	.L.42
VB1B1E0CA20H1	.L.38
VB1B1F0CA20H1	.L.38
VB1B1J0BA24H1	.L.38
VB1B1J0BA30P1	.L.39
VB1B1L2BN12J1	.L.42
VB1B1L2BN24H1	.L.42
VB1B1N3BN12J1	.L.43
VB1B1N3BN24H1	.L.43
VB1B1N3BN30P1	.L.43
VB1B1P3BN12J1	.L.43
VB1B1P3BN24H1	.L.43
VB1B1P3BN30P1	.L.24
VB1B1L4BT24M1	.L.42
VB1B1L4CN48M1	.L.41, L.42
VB1B2C3BN30P1	.L.44
VB1C1J0BA30U1	.L.39
VB1D1Q3BN30P1	.L.43
VP24382TV25Y	.B.65
VWS106-C	.C.45
VWS106-C2	.C.45
VWSDC-C	.C.45
VWSDC-C20	.C.45

Part Number	Page Number
W	
WB89D	.B.72
WBH1	.L.84
WBH2	.L.84
WBH3	.L.84
WBH4	.L.84
WBH2E	.L.84
WBH4E	.L.84
WBH6E	.L.84
WBS6-Q	.P.42
WBS6-Q60	.P.42
WG12BL10	.J.67
WG12FRTBBL	.J.70
WG18BL10	.J.67
WG18FRTBBL	.J.70
WG24BL10	.J.67
WG24FRTBBL	.J.70
WG30BL10	.J.67
WG30FRTBBL	.J.70
WGBTMWFBL	.J.68
WGCB12BL	.J.69
WGCB18BL	.J.69
WGCB24BL	.J.69
WGCT-A	.J.73
WGCT-HEAD	.J.73
WGCT-M	.J.73
WGHRDWKTBL	.J.71
WGINTBRC2BL	.J.71
WGINTBRC4BL	.J.71
WGINTBRC6BL	.J.71
WGINTSPLBL	.J.68
WGSDWL2BL	.J.71
WGSDWL4BL	.J.71
WGSDWL6BL	.J.71
WGSDWWF4BL	.J.68
WGSPL1218BL	.J.68
WGSPL2430BL	.J.68
WGSTRKTBL	.J.70
WGTB12BL	.J.69
WGTB18BL	.J.69
WGTB24BL	.J.69
WGTB30BL	.J.69
WGWMTB12BL	.J.69
WGWMTB1830BL	.J.69
WMCEPE	.E.8
WMP1E	.L.77
WMP1E-V	.L.77
WMPF1E	.L.77
WMPF1E-X	.L.77
WMPFSE	.L.77
WMPH2E	.L.77
WMPHF2E	.L.77
WMPLFSE	.L.77
WMPLFSE-E	.L.77
WMPLSE	.L.77
WMPSE-X	.L.77

Part Number	Page Number
WMPSE	.L.77
WMPV22E	.L.75
WMPV45E	.L.75
WMPV45EP	.L.75
WMPV45ERTW	.L.74, L.75
WMPVCBE	.L.75
WMPVCMB	.L.75
WMPVF22E	.L.75
WMPVF45E	.L.75
WMPVHC45E	.L.75
WMPVHCF45E	.L.75
WMPVSMK	.L.74, L.75
WPT-8	.B.98
WR2-C	.P.12
WR2H-C	.J.52, P.12
WR3-C	.P.12
WR4-C	.P.12
WR5-C	.P.12
WR5E-X	.L.68, L.49, L.50, L.74, L.75

Panduit® Pan-Net® Performance Guarantee

All Panduit® Pan-Net® non-consumable products have a 20 year performance guarantee. When installed per TIA or ISO/IEC standards, the Panduit® Pan-Net® Network Cabling System will operate the application(s) which the system was designed to support.

Applications may include, but are not limited to:

10/100/1000 Mbps Ethernet (IEEE 802.3)

100 Base FX

100 Base 4

100 Base TX

4/16 Mbps Token Ring (IEEE 802.5)

155, 622, 1.25 Gbps ATM

SONET

FDDI/CDDI

10G Ethernet

FOIRL

TPDDI

32 Mbps Token Ring

IBM System 3x-AS/400

Appletalk

ISDN

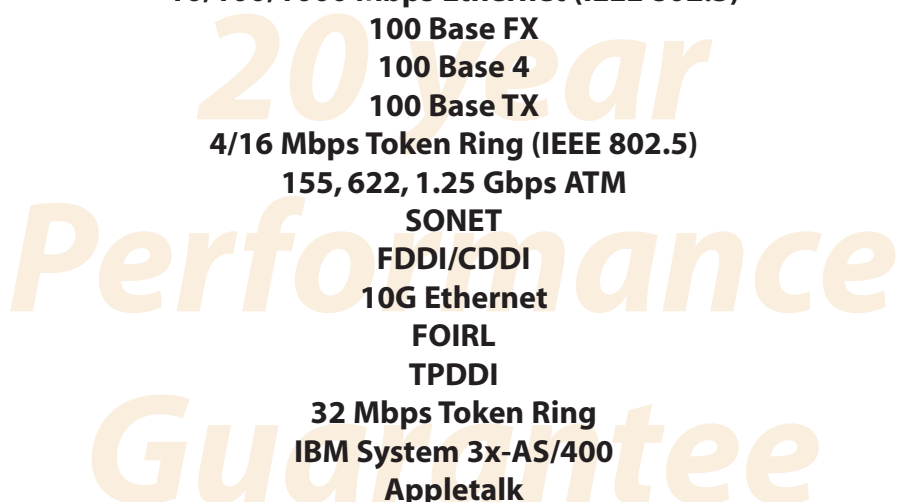

In order to qualify for the guarantee, the structured cabling system must be installed per the following:

1. Meet all TIA/EIA commercial building wiring standards.
2. Panduit categorized product must be used in conjunction with an equivalent or higher Category UL or ETL verified cable.
3. Panduit products must be installed per appropriate Panduit instruction sheets.

Note: All networks shall be installed per applicable standards and manufacturer's guidelines.

If any Panduit® Pan-Net® product fails to perform as stated above, Panduit will provide new components at no charge.

THIS GUARANTEE IS MADE IN LIEU OF AND EXCLUDES ALL OTHER WARRANTIES, EXPRESSED OR IMPLIED. THE IMPLIED WARRANTIES OF MERCHANTABILITY AND FITNESS FOR A PARTICULAR USE ARE SPECIFICALLY EXCLUDED. Neither seller nor manufacturer shall be liable for any other injury, loss or damage, whether direct or consequential. Before using, user shall determine the suitability of the product for its intended use and user assumes all risk and liability whatsoever in connection therewith. The foregoing may not be altered except by an agreement signed by officers of seller and manufacturer.

Panduit is committed to maintaining a leadership position in the Network Connectivity Market.

As new technologies evolve, Panduit will continue to develop state-of-the-art components which will be added to the Pan-Net® product line.

Panduit is a global leader in cabling and communication products, delivering end-to-end solutions in support of demanding electrical and networking requirements.

Panduit Catalogs

Electrical Solutions

SA-ELCB10

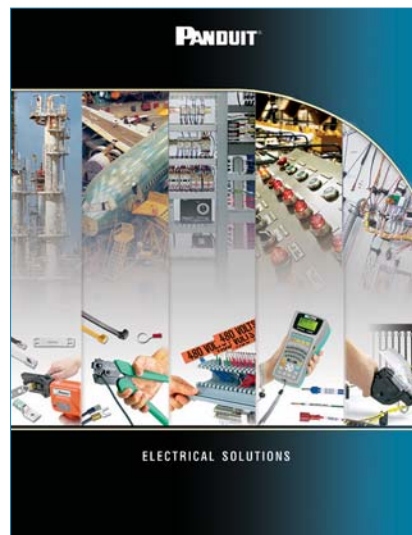

- Cable Ties
- Cable Accessories
- Stainless Steel
- Wiring Duct
- Surface Raceway
- Abrasion Protection
- Cable Management
- Terminals
- Power and Grounding Connectors
- Labeling System
- Labels
- Pre-Printed and Write-On Markers
- Lockout/Tagout and Safety Solutions